



# CLASSIC

10712



7 [LEGO.com/classic](https://www.lego.com/classic)





[LEGO.com/brickseparator](https://www.LEGO.com/brickseparator)



Easy building  
Einfach zu bauen  
Construction facile  
Costruzione facile  
Construcción fácil  
Construção fácil  
Kezdő építőknek  
简单拼砌



Medium building  
Mittelschwer  
Construction intermédiaire  
Costruzione media  
Construcción intermedia  
Construção intermédia  
Gyakorló építőknek  
中级拼砌



Advanced building  
Fortgeschritten  
Construction avancée  
Costruzione avanzata  
Construcción avanzada  
Construção avançada  
Tapasztalt építőknek  
高级拼砌



Page

6

Page

18



Page

Seite

Page

Pagina

Página

Página

oldalszám

页码

Page  
**26**



Page  
**48**



Page  
**40**



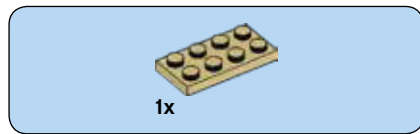

1





2x

2

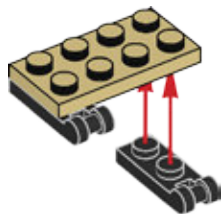

1x

3

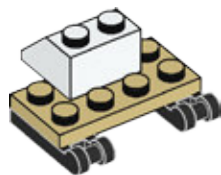

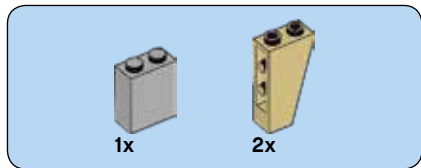

4

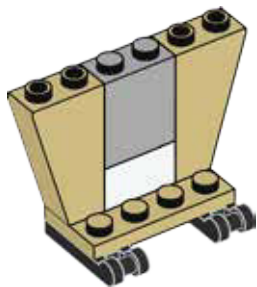



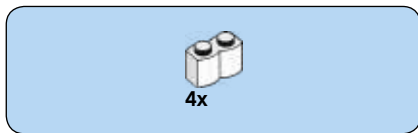

5

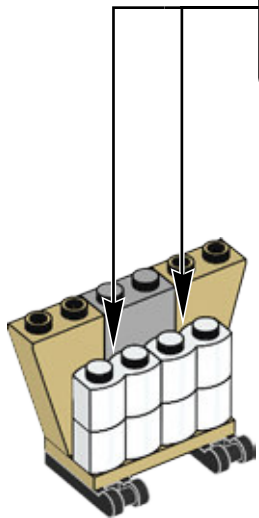
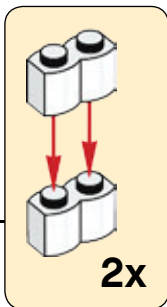

6

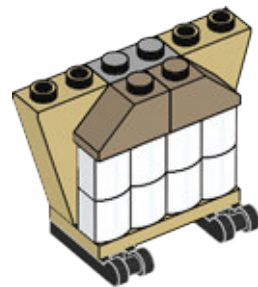



1x



2x

7

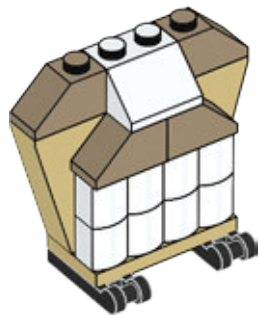



2x



1x

8

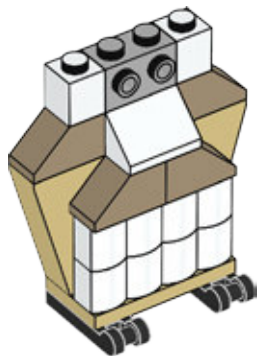

1x



1x

9

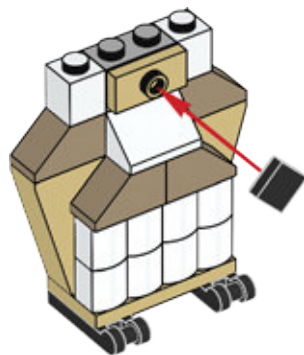



1x

10

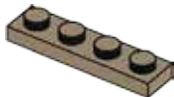



2x

11

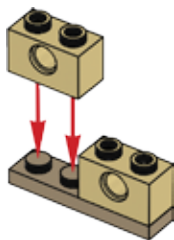

1x

12

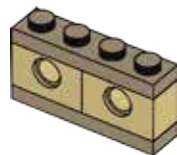



1x



1x

# 13

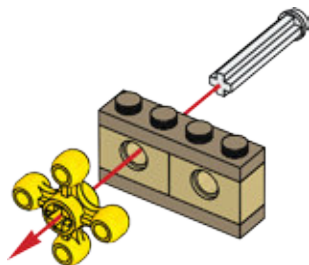

14



1x



1x

# 14

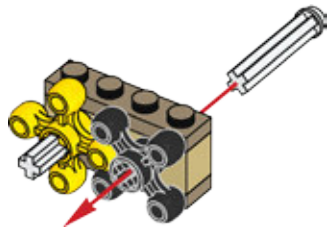

1x

# 15

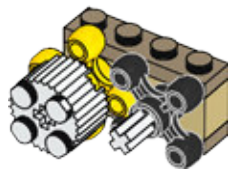

16

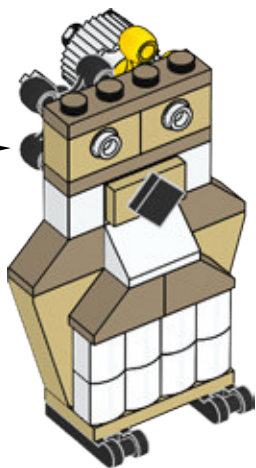
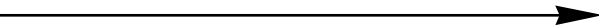





2x



2x

17

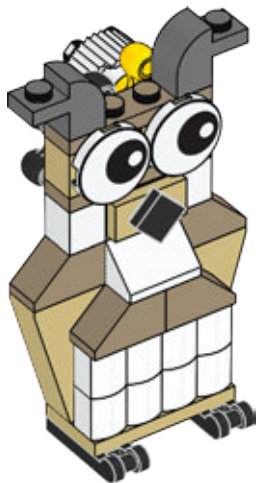

LEGO.com/classic

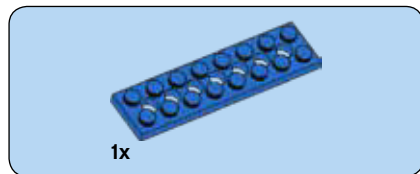

1

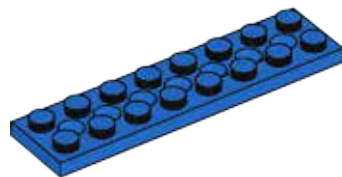



3x

2

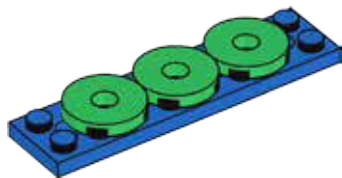

2x

3

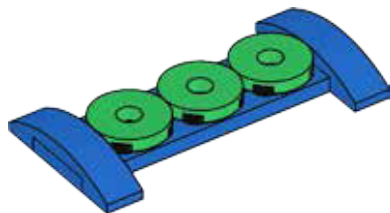

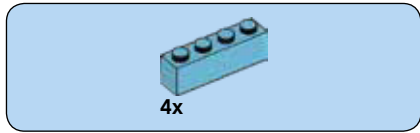

4

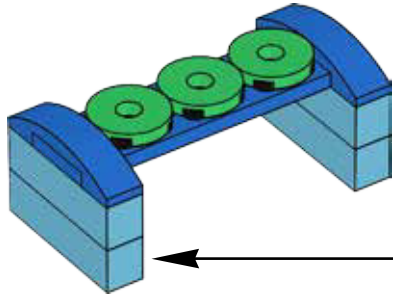
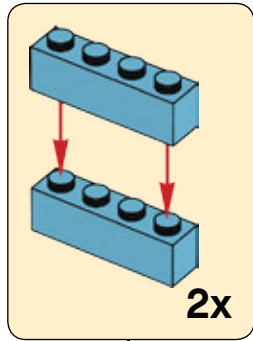

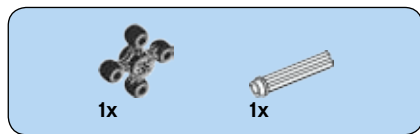

5

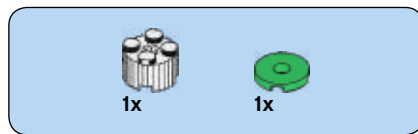
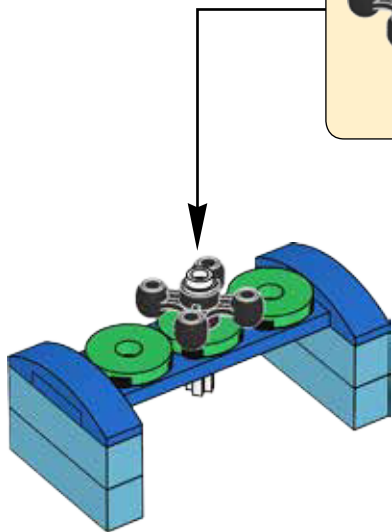
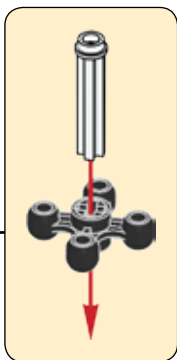

6

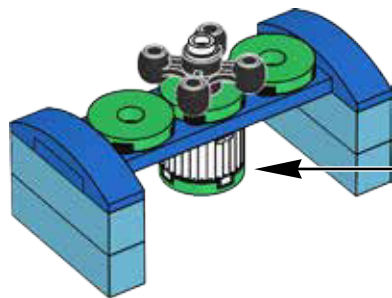
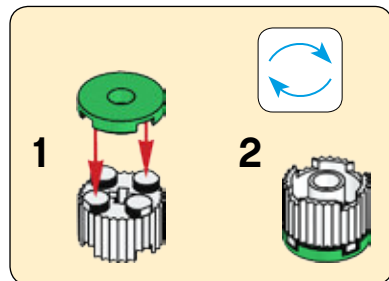



7

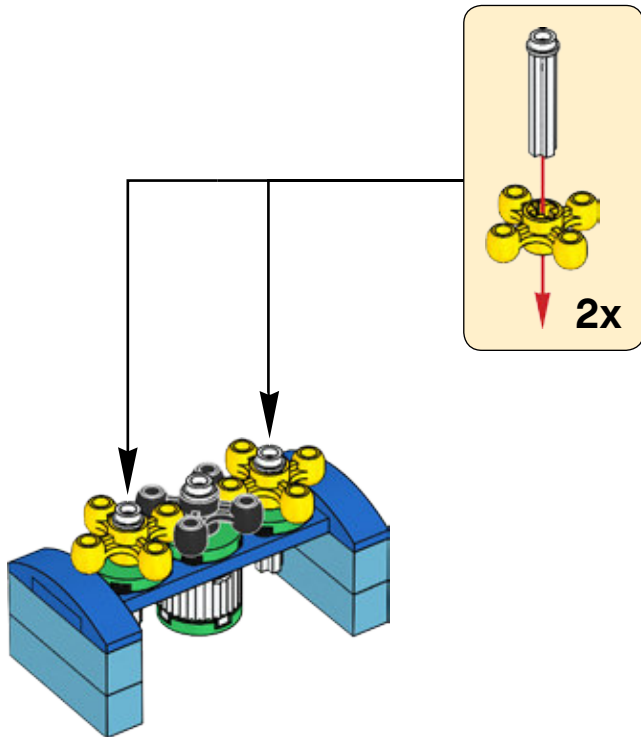



3x

8

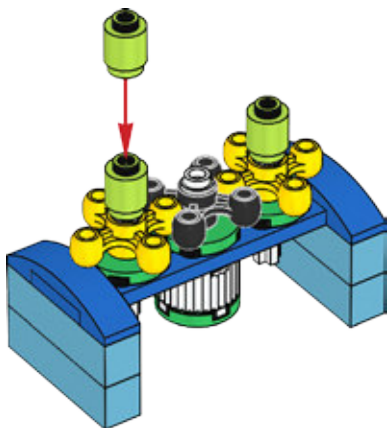

1x



2x

9

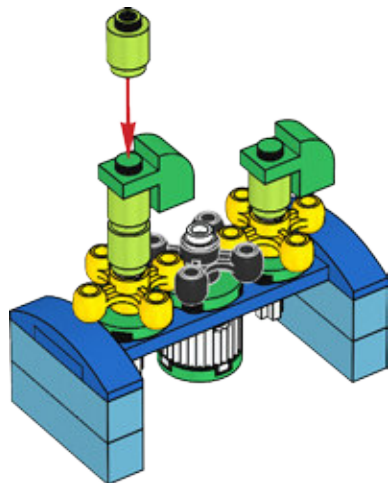



2x

10

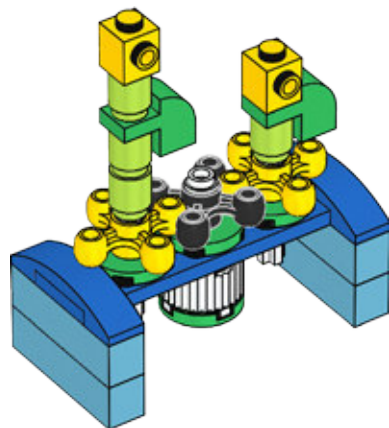



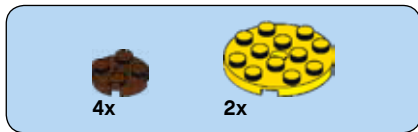

11

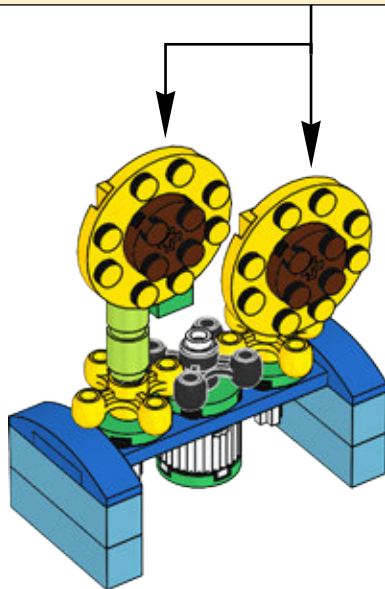
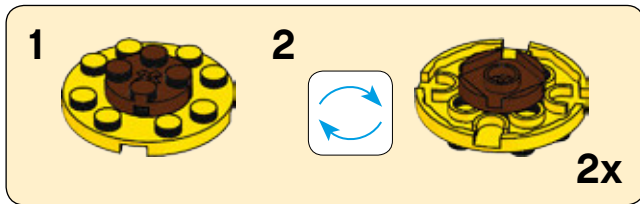

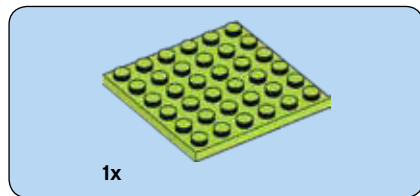

1

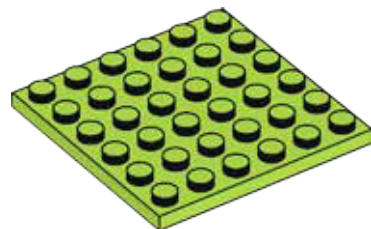

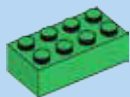

1x

2

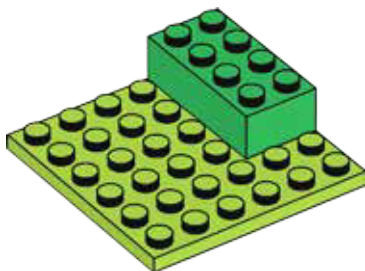



2x

3

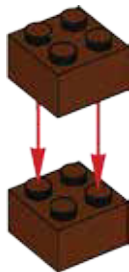

2x

4

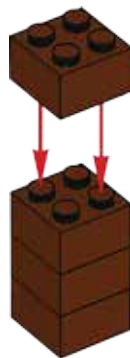



5



6

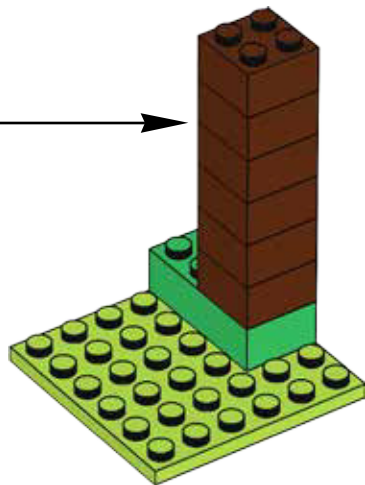

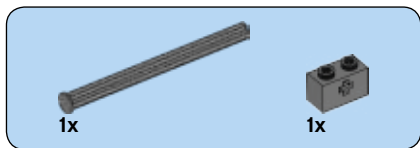
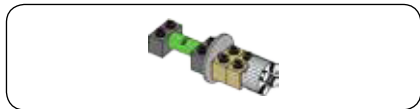

7

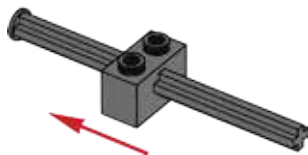



8

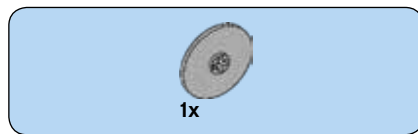
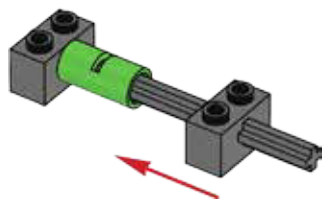

9

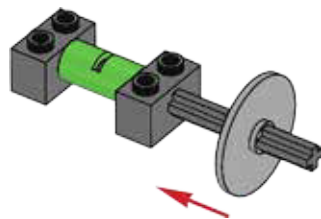



2x

10

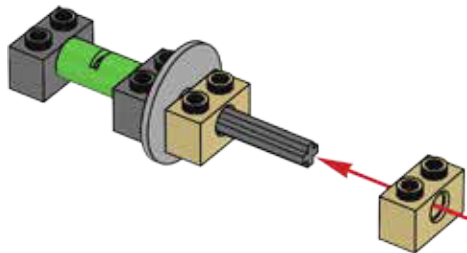





1x

11

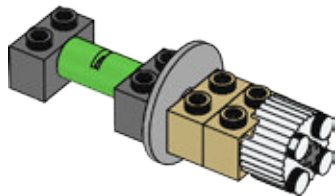

12

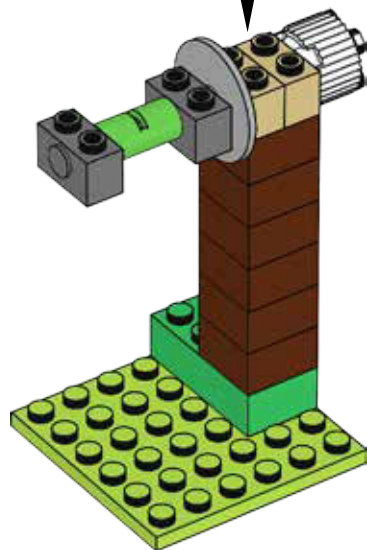



1x

13

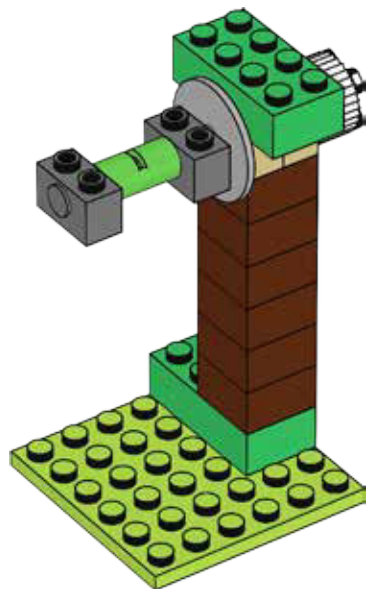



1x



1x

# 14

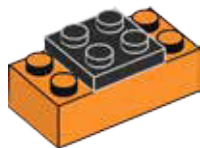

1x



1x

# 15

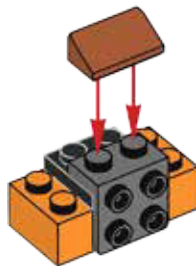



2x



1x

# 16

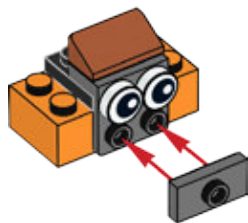

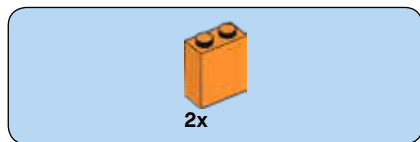

17

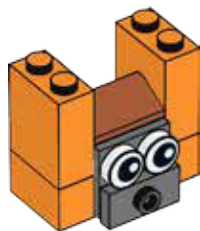

18

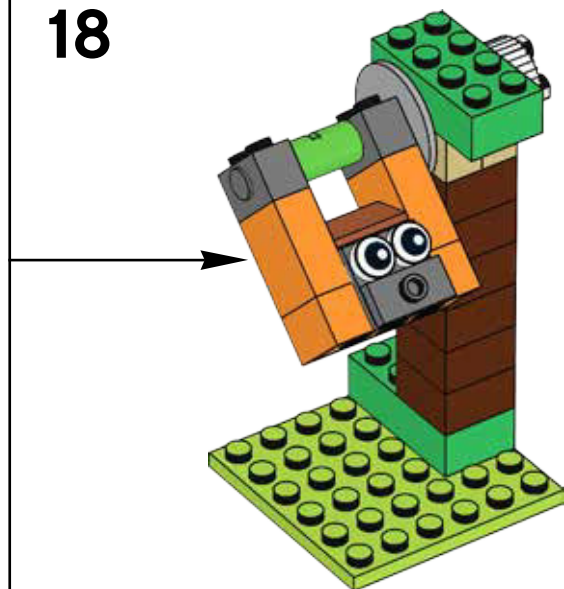

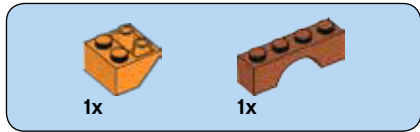

19

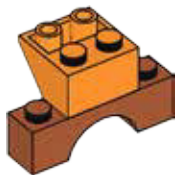

20

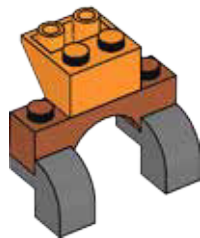

21

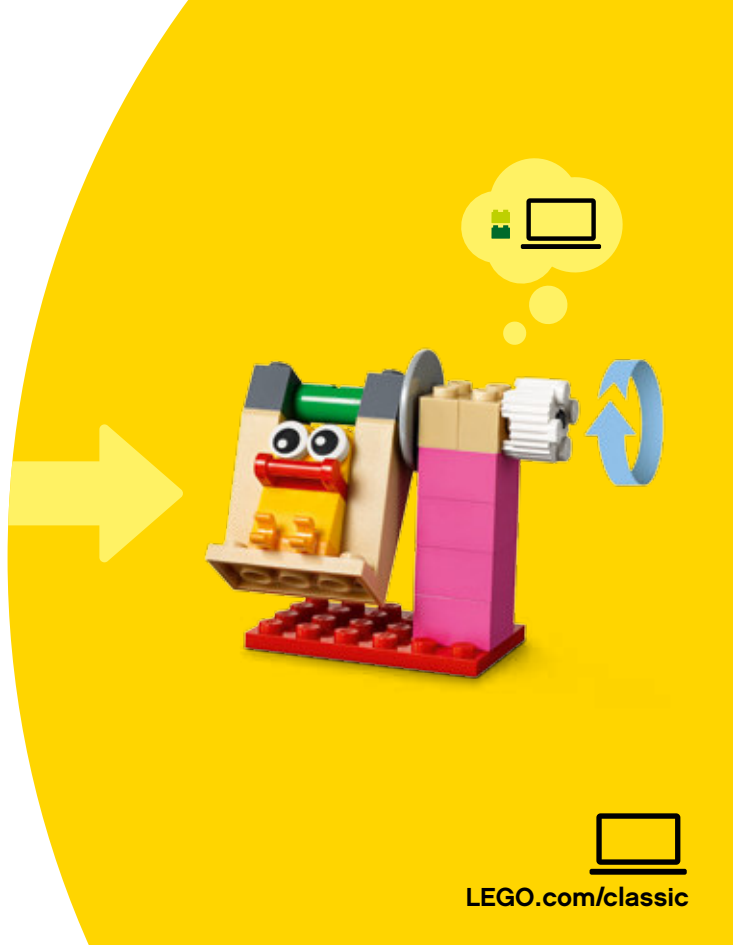
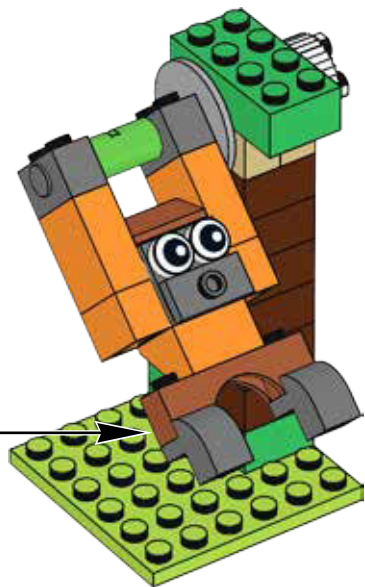

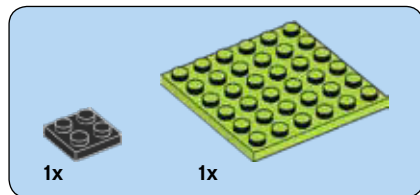

1

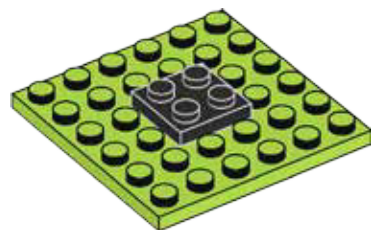





2

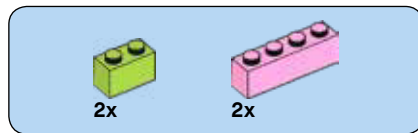
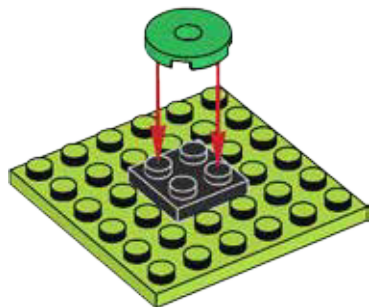

3

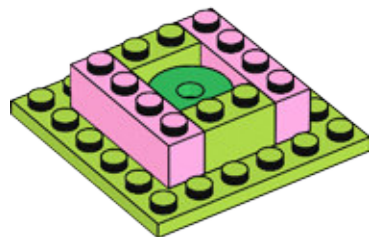



2x

4

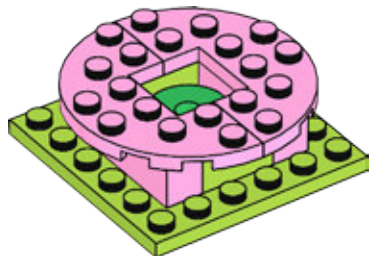

1x

5

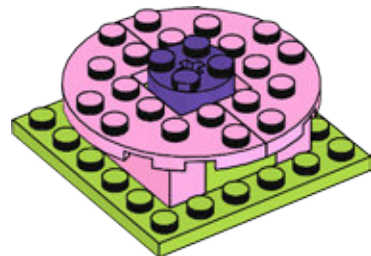

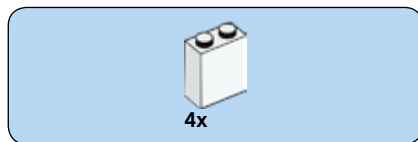

6

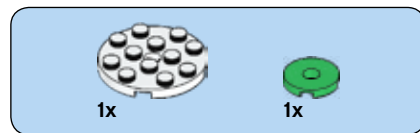
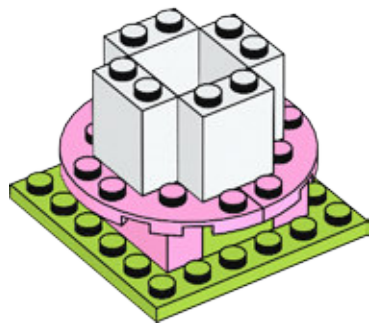

7

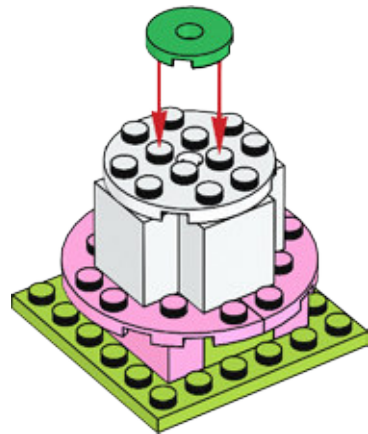

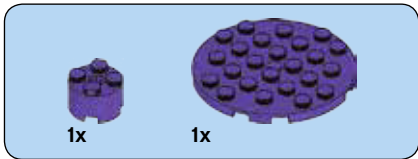

8

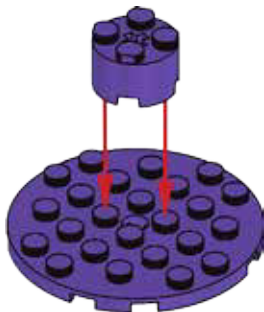

9





4x



4x

# 10



4x



4x

# 11

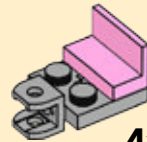

4x

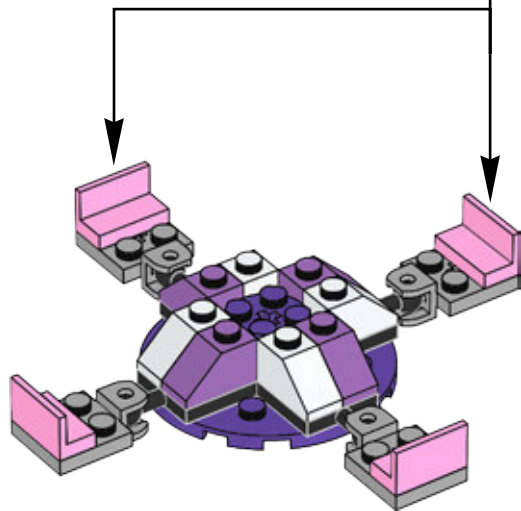

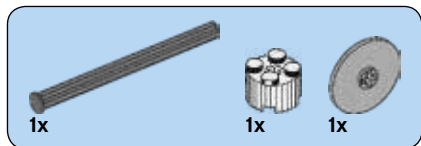

12

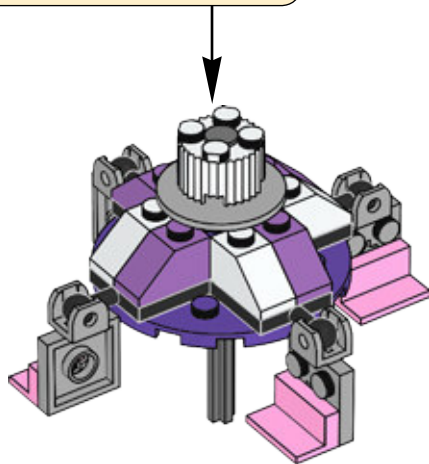
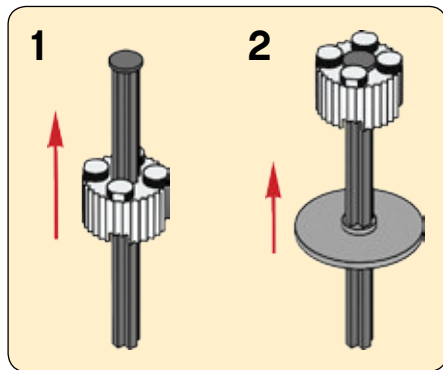

13

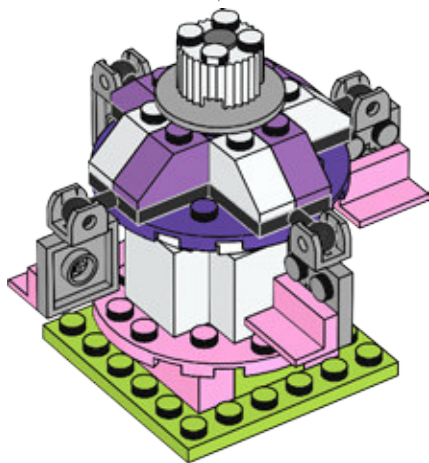

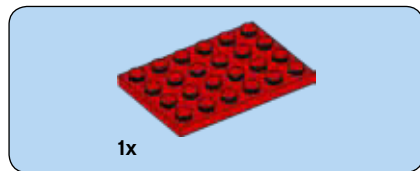

1





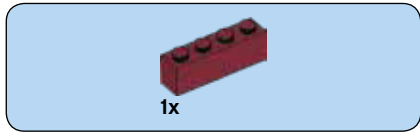

2

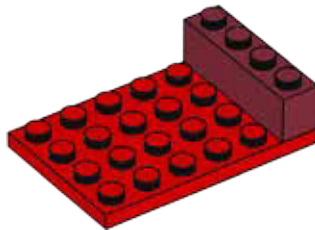

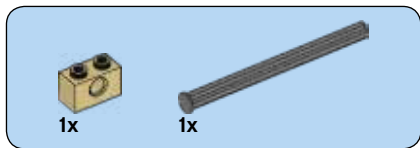
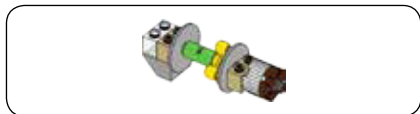

3

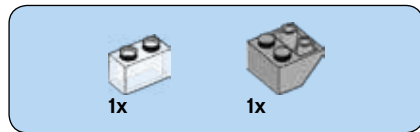
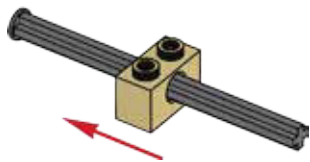

4

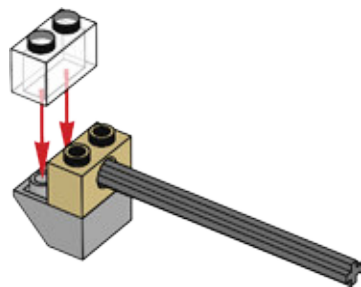

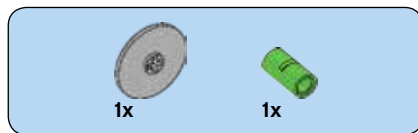

5

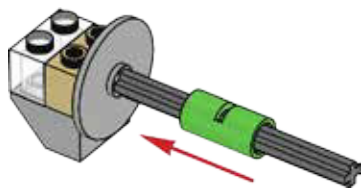

6

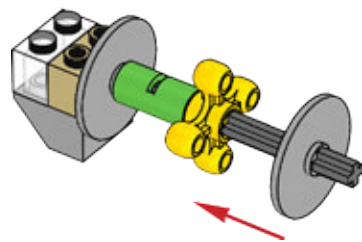



1x



1x

7

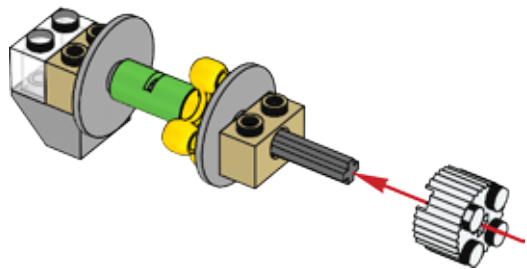

1x

8

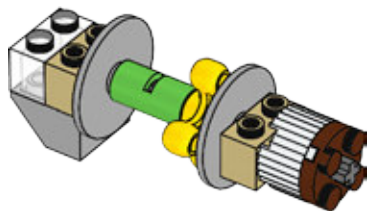

9

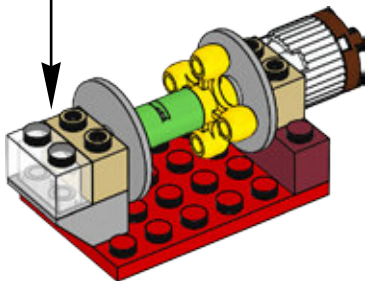

10

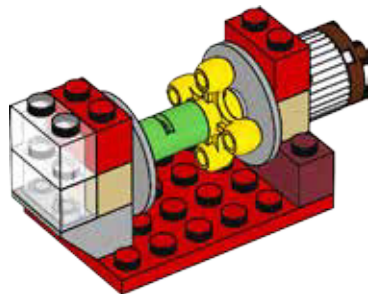

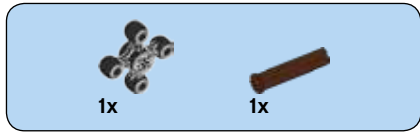

11

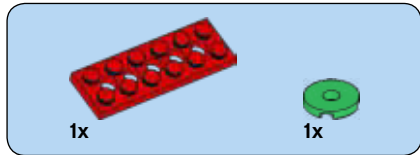

12

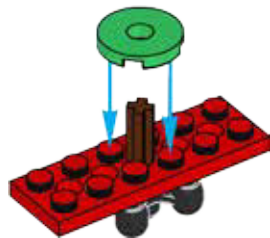



1x

13

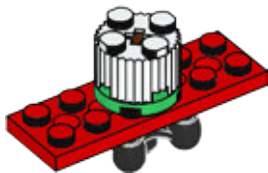

14

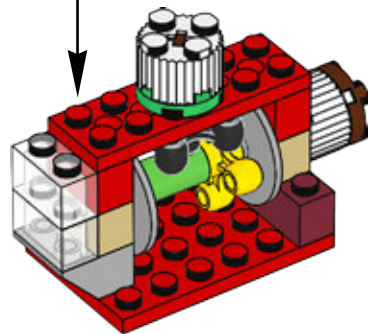

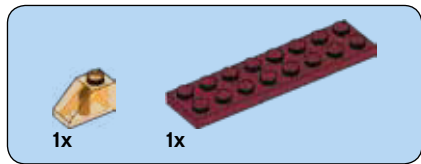

15

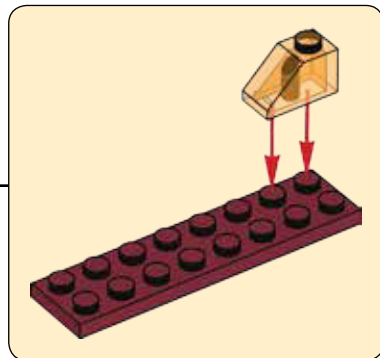
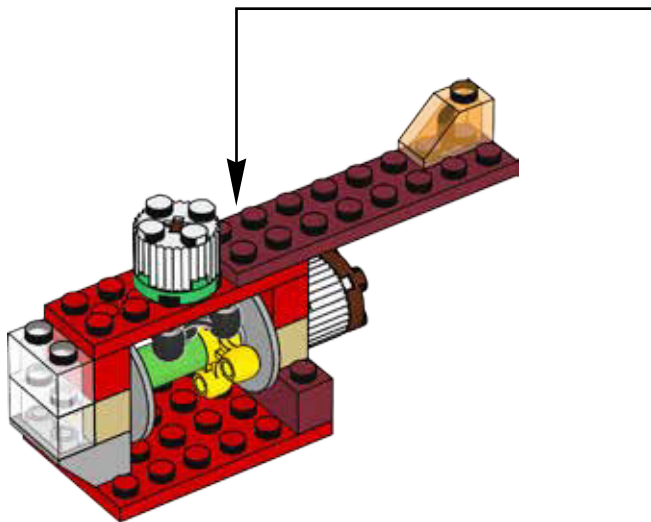



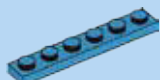

2x

16

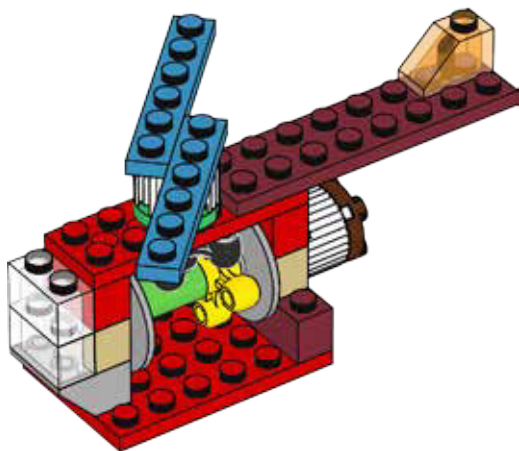

2x

17

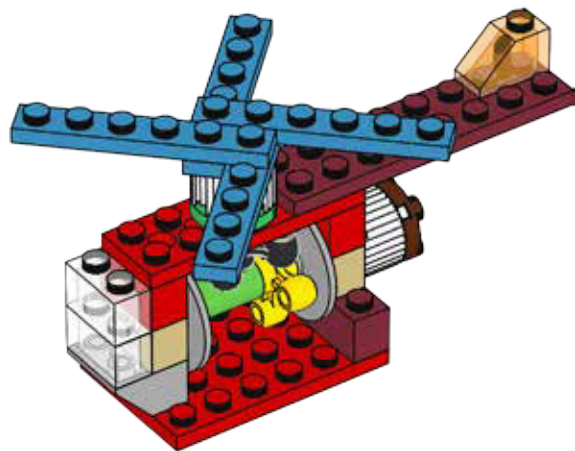



1x

18

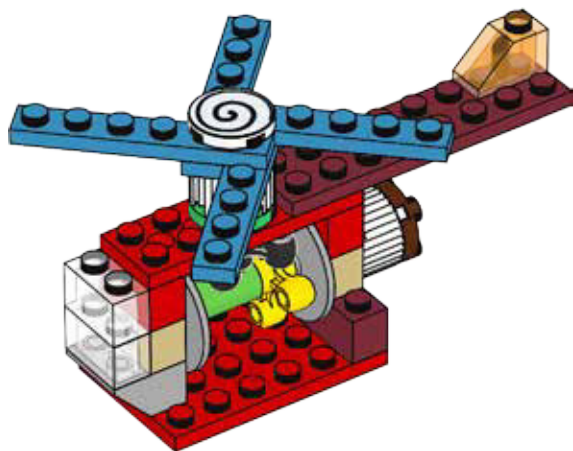

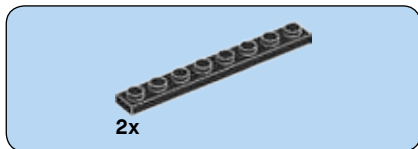
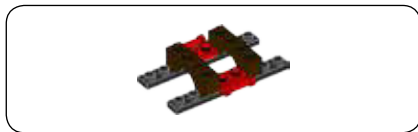

19

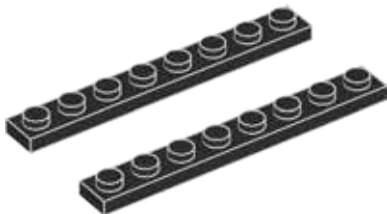

20

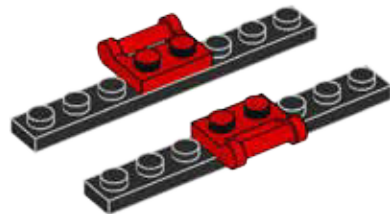



2x

21

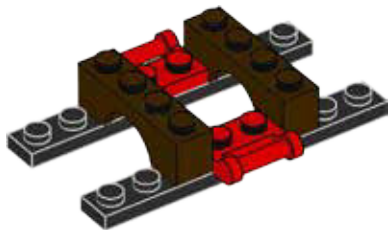

22

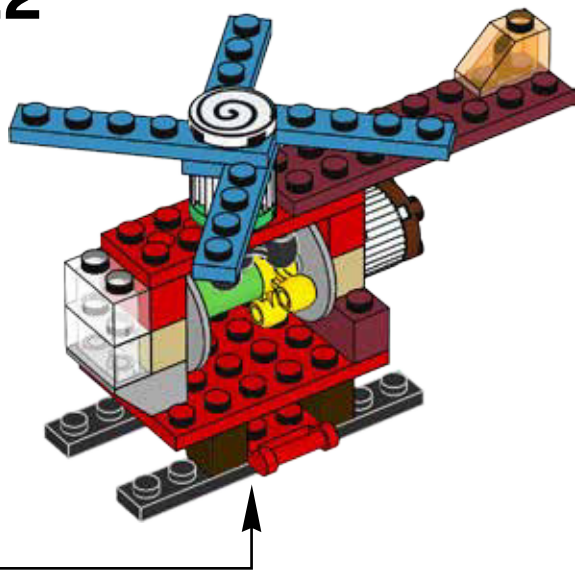

## What will you build for Mr. Stareyes' adventures?

Was wirst du für Mr. Stareyes Abenteuer bauen?

Que vas-tu construire pour les aventures de M. Œil-Fou ?

Cosa costruirai per le avventure del Sig. Grandiocchi?

¿Qué construirás para las aventuras de Mr. Stareyes?

O que vais construir para as aventuras do Sr. Stareyes?

Mit építész Csillagnézó úr kalandjaihoz?

您会为星眼先生的大冒险拼搭些什么呢？





10698



10696



10700



10714



10713



10701





# CITY



60170



60171



60172



60173



60174



60176





# CREATOR

3<sup>in</sup>1

3 in 1  
3 en 1  
3 em 1  
3 az egyben  
3合1



31075

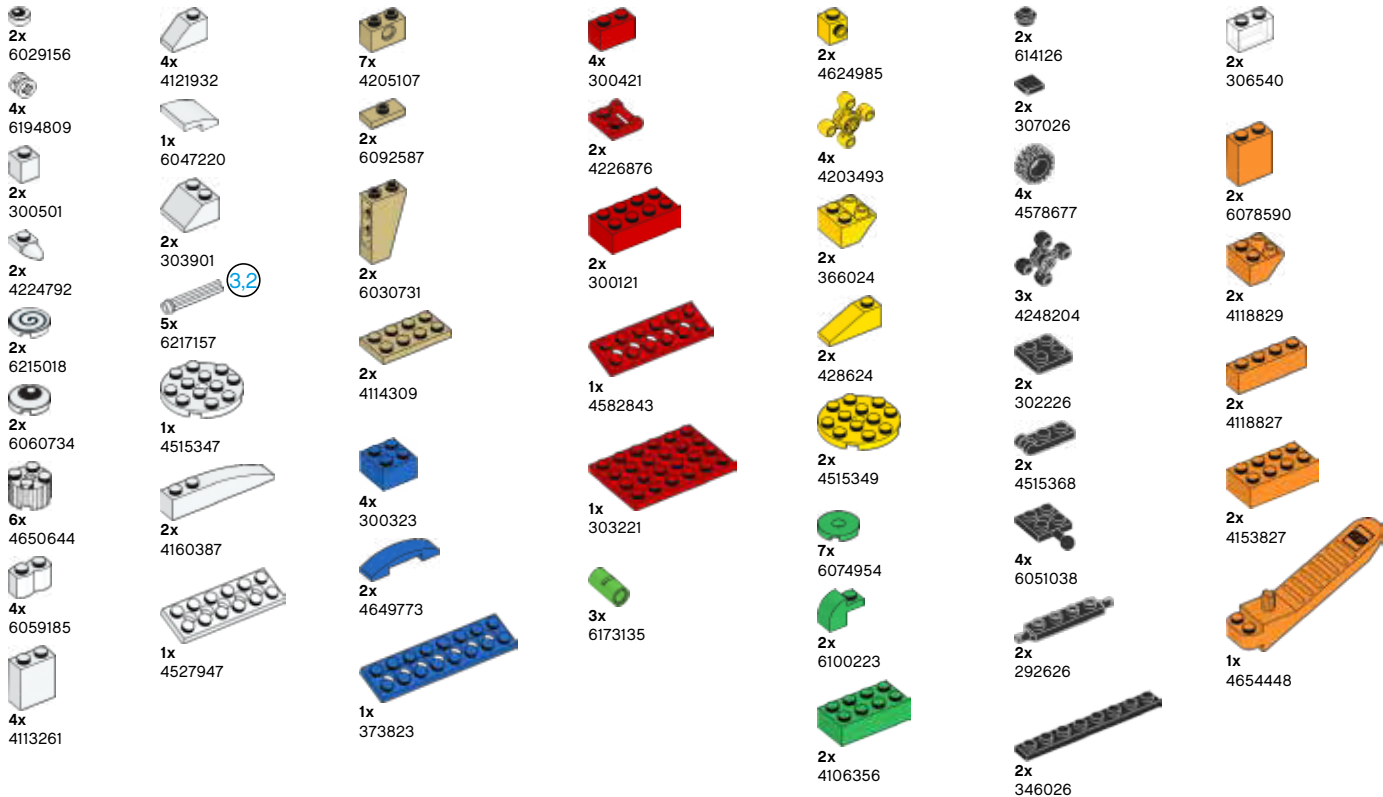

4x  
4530678

2x  
4626904

2x  
6052777

1x  
6152321

4x  
4212454

2x  
4164022

2x  
4234716

2x  
4525858

2x  
6188477

2x  
6212897

2x  
6022650

2x  
6093459

4x  
6132408

1x  
6057616

2x  
6015344

2x  
4211564

2x  
4211614

4x  
4667578

4x  
4530469

1x  
4211436

2x  
6178919

4x  
4210797

4x  
6013658

2x  
6092572

1x  
6117972

3x  
4499858

4x  
4517992

5x  
4211159

6x  
4211210

2x  
6135494

4x  
6146231

2x  
4518890

2x  
6133060

2x  
6036232

1x  
6102580

2x  
4622176

1x  
6216908

2x  
4623775

2x  
6004943

4x  
6151657

4x  
6036238

4x  
6022005

3

8

Customer Service  
Kundenservice  
Service Consommateurs  
Servicio Al Consumidor

LEGO.com/service or dial



: 00800 5346 5555

: 1-800-422-5346

# WIN

GO TO [WWW.LEGO.COM/PRODUCTFEEDBACK](http://WWW.LEGO.COM/PRODUCTFEEDBACK) AND  
GIVE US YOUR SHORT **FEEDBACK** ABOUT THIS  
LEGO® SET FOR A CHANCE TO WIN  
A COOL LEGO PRIZE.

Terms & Conditions apply

## LEGO.com/productfeedback



### GEWINNE

Erzähle uns auf  
[www.LEGO.com/productfeedback](http://www.LEGO.com/productfeedback)

etwas über die Erfahrungen, die du mit  
diesem LEGO® Set gemacht hast, und  
sichere dir die Chance auf einen coolen  
LEGO Preis!

Es gelten die Teilnahmebedingungen

### GAGNE

Rends-toi sur  
[www.LEGO.com/productfeedback](http://www.LEGO.com/productfeedback)

et donne-nous quelques commentaires sur  
ce produit LEGO® pour avoir une chance  
de gagner un prix LEGO !

Voir Conditions Générales

### GANAN

Visita  
[www.LEGO.com/productfeedback](http://www.LEGO.com/productfeedback)

y envíanos tu opinión acerca de este set  
LEGO®. ¡Participarás en el sorteo de un  
premio LEGO!

Términos y Condiciones aplicables

### 获取奖品

登录  
[www.LEGO.com/productfeedback](http://www.LEGO.com/productfeedback)

给出关于此乐高®套装的简短反馈，  
就有机会获得炫酷乐高奖品

《条款及条件》适用

LEGO and the LEGO logo are trademarks of the LEGO Group. ©2018 The LEGO Group.

6225658



**CLASSIC**



**10712**





Warning! Choking hazard. Small parts.  
Achtung! Erstickungsgefahr. Kleine Teile.  
Attention ! Danger d'étouffement. Petits éléments.  
Avvertenza! Rischio di soffocamento. Piccole parti.  
Waarschuwing! Verstikkingsgevaar. Kleine onderdelen.  
¡Advertencia! Peligro de atragantamiento. Partes pequeñas.  
Advarsel! Kvælningsfare. Små dele.  
Viðvörðun! Kófnunarhætta. Litlir hlutir.  
Varoitus! Tukehtumisvaara. Pieniä osia.  
Varning! Kvävningrisk. Små delar.  
Advarsel! Kvelningsfare. Små deler.  
Atenção! Risco de asfixia. Pequenas partes.  
Προειδοποίηση! Κίνδυνος πνιγμού. Μικρά μέρη.  
警告! 小部品があります。誤飲・窒息の危険があります。  
警告! 小心窒息。当心小物件。  
경고! 질식 위험. 작은 부품 포함.  
Внимание! Риск удушения. Мелкие детали.  
Ostrzeżenie! Niebezpieczeństwo udławienia się. Małe części.  
Upozornění! Nebezpečí zalknutí. Malé části.  
Upozornenie! Nebezpečenstvo dusenia. Malé časti.  
Figyelmeztetés! Fulladásveszély. Kis alkatrészek.  
Ποпередження! Ризик задухи. Дрібні деталі.  
Urozorenje! Opasnost od gušenja. Mali dijelovi.  
Упозорење! Опасност од гушења. Мали делови.  
Предупредување! Опасност од задушвање. Мали делови.  
Orozorilo! Nevarnost zadušitve zaradi tujka. Majhni deli.  
Avertisment! Pericol de sufocare internă. Părți mici.  
Внимание! Опасност от задавяне. Малки части.  
Brīdinājums! Aizrīšanās risks. Sīkas detaļas.  
Hoiatus! Kähgistamisohu. Väikesed osad.  
İspējimas! Pavojus užspringti. Smulkios detalės.  
Uyarı! Boğulma Tehlikesi (Havasızlıktan). Küçük Parçalar.  
تحذیر! خطر الاختناق. أجزاء صغيرة.  
Peringatan! Bahaya tersedak. Bagian kecil.  
Amaran! Bahaya tercekik. Bahagian kecil.



**WARNING: CHOKING HAZARD.**  
Small parts. Not for children under 3 years.



**AVERTISSEMENT : RISQUE D'ÉTOUFFEMENT.**  
Contient des petites pièces. Ne convient pas aux enfants de moins de 3 ans.



**ADVERTENCIA: PELIGRO DE ASFIXIA.**  
No recomendado para niños menores de 3 años. Contiene piezas pequeñas.

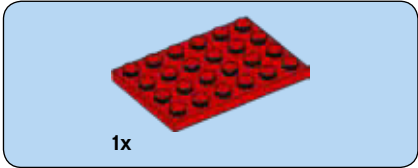
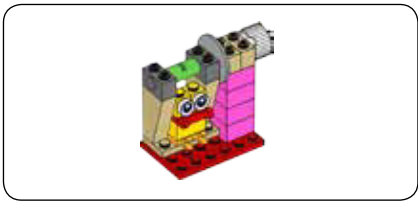

1

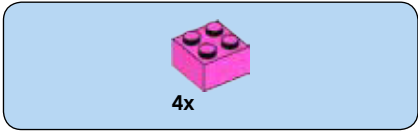
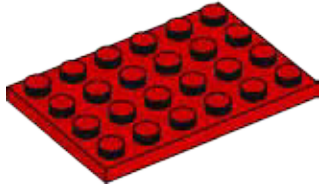

2

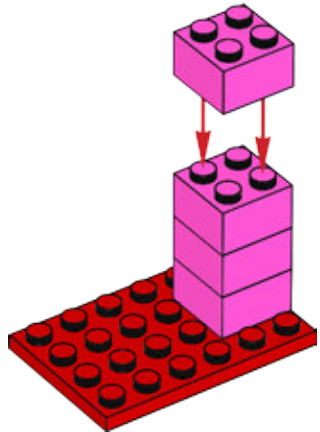

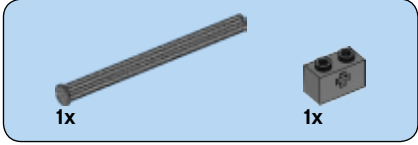
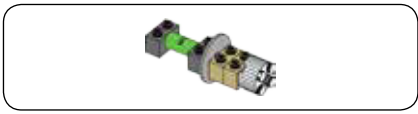

3

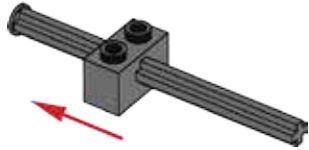

4

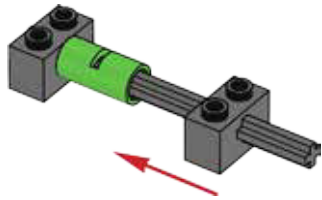



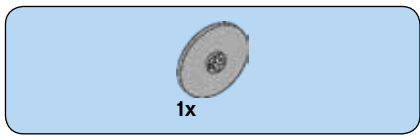

5

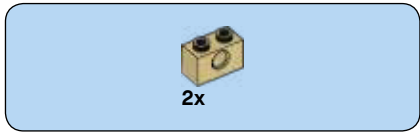
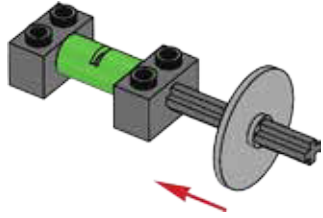

6

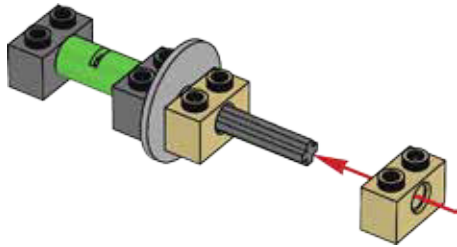



1x

7

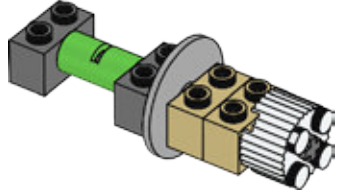

8

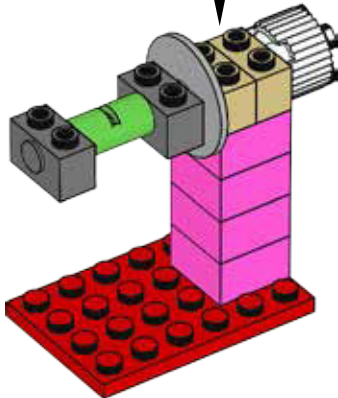

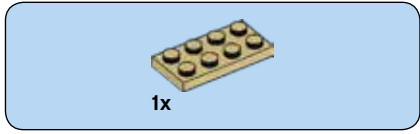

9

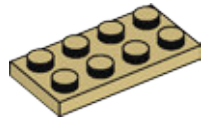

10

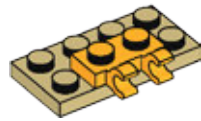



11

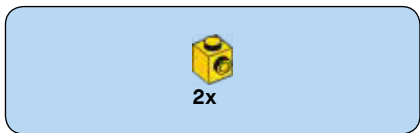
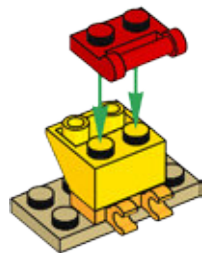

12

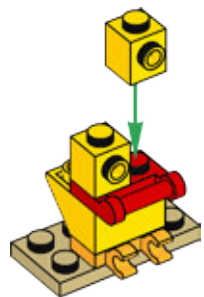



2x

13

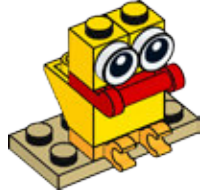

2x

14



15

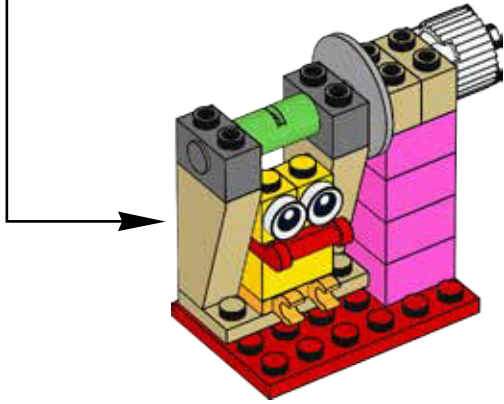



LEGO and the LEGO logo are trademarks of the/sont des marques de commerce du/son marcas registradas de LEGO Group. ©2018 The LEGO Group.



# CLASSIC



10712





Warning! Choking hazard. Small parts.  
Achtung! Erstickungsgefahr. Kleine Teile.  
Attention ! Danger d'étouffement. Petits éléments.  
Avvertenza! Rischio di soffocamento. Piccole parti.  
Waarschuwing! Verstikkingsgevaar. Kleine onderdelen.  
¡Advertencia! Peligro de atragantamiento. Partes pequeñas.  
Advarsel! Kvælningsfare. Små dele.  
Viðvörðun! Kófnunarfættta. Litlir hlutir.  
Varoitus! Tukehtumisvaara. Pieniä osia.  
Varning! Kvävningrisk. Små delar.  
Advarsel! Kvelningsfare. Små deler.  
Atenção! Risco de asfixia. Pequenas partes.  
Προειδοποίηση! Κίνδυνος πνιγμού. Μικρά μέρη.  
警告! 小部品があります。誤飲・窒息の危険があります。  
警告! 小心窒息。当心小物件。  
경고! 질식 위험. 작은 부품 포함.  
Внимание! Риск удушения. Мелкие детали.  
Ostrzeżenie! Niebezpieczeństwo udławienia się. Małe części.  
Upozornění! Nebezpečí zalknutí. Malé části.  
Upozornenie! Nebezpečenstvo dusenia. Malé časti.  
Figyelmeztetés! Fulladásveszély. Kis alkatrészek.  
Πολερδζηννη! Ριζικ ζαδυχι. Δριβνη δεταλι.  
Urozorenje! Opasnost od gušenja. Mali dijelovi.  
Упозорење! Опасност од гушења. Мали делови.  
Предупредување! Опасност од задушвање. Мали делови.  
Opozorilo! Nevarnost zadušitve zaradi tujka. Majhni deli.  
Avertisment! Pericol de sufocare internă. Părți mici.  
Внимание! Опасност от задавяне. Малки части.  
Brīdinājums! Aizrīšanās risks. Sīkas detaļas.  
Hoiatus! Kägistamisohr. Väikesed osad.  
İspėjimas! Pavojus užspringti. Smulkios detalės.  
Uyarı! Boğulma Tehlikesi (Havasızlıkta). Küçük Parçalar.  
تحذیر! خطر الاختناق. أجزاء صغيرة.  
Peringatan! Bahaya tersedak. Bagian kecil.  
Amaran! Bahaya tercekik. Bahagian kecil.



**WARNING: CHOKING HAZARD.**  
Small parts. Not for children under 3 years.



**AVERTISSEMENT : RISQUE D'ÉTOUFFEMENT.**  
Contient des petites pièces. Ne convient pas aux enfants de moins de 3 ans.



**ADVERTENCIA: PELIGRO DE ASFIXIA.**  
No recomendado para niños menores de 3 años. Contiene piezas pequeñas.

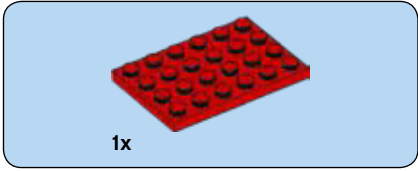
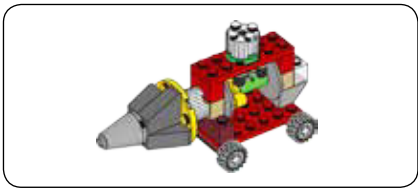

**1**

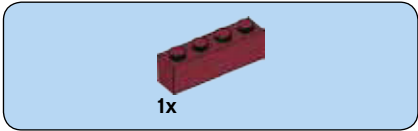

**2**

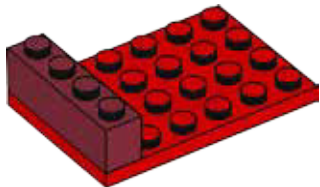

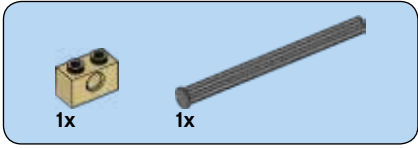
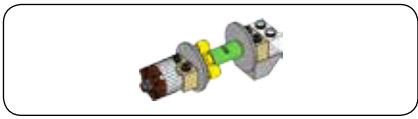

3

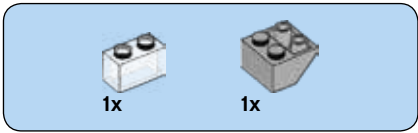
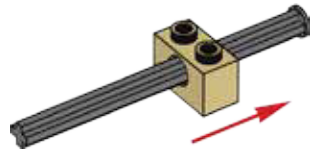

4

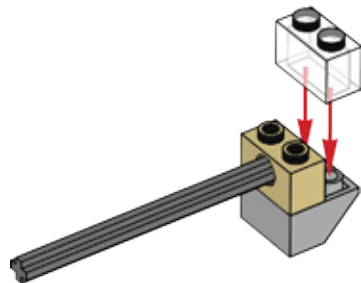

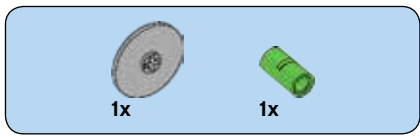

5

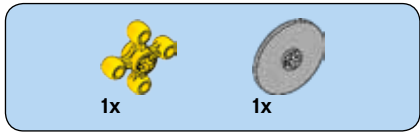
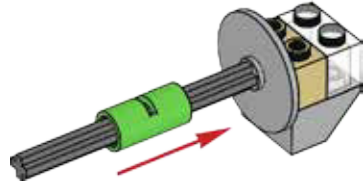

6

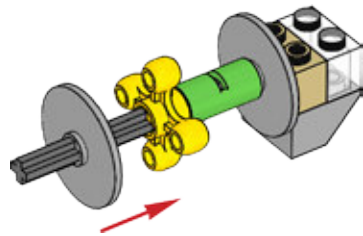



7

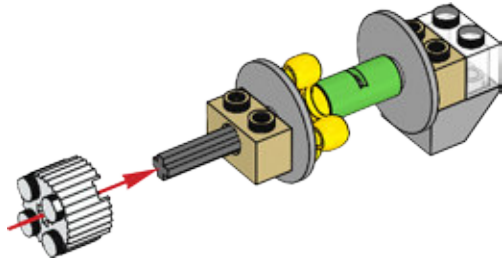

8

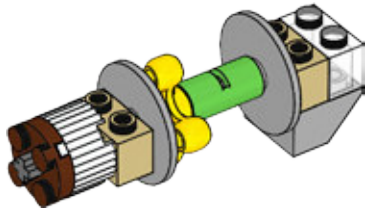

9

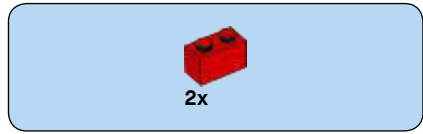
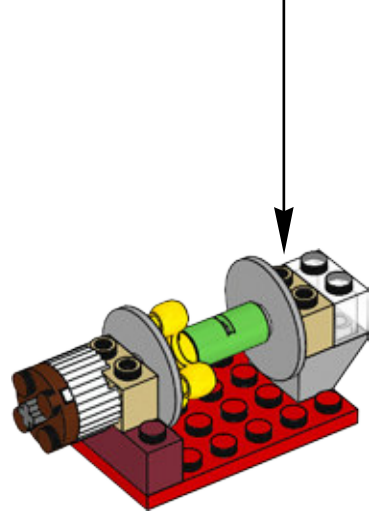

10

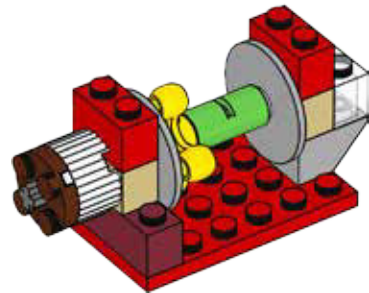

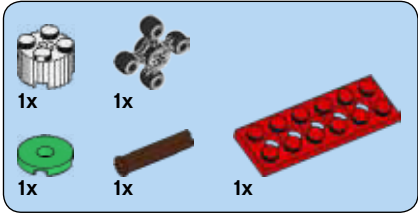

# 11

1



2

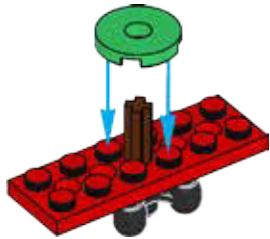

3

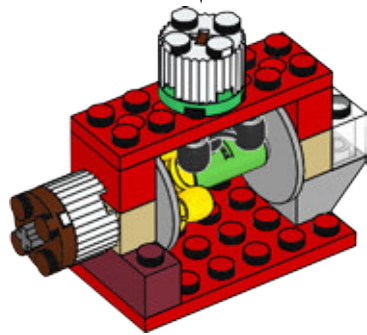
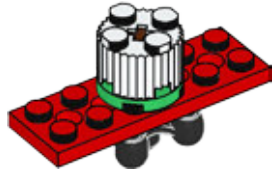



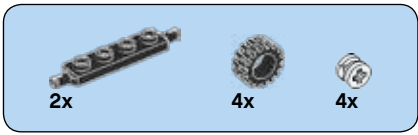

12

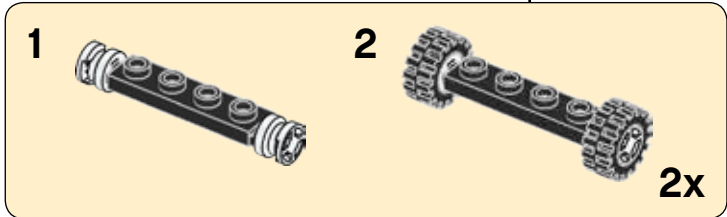
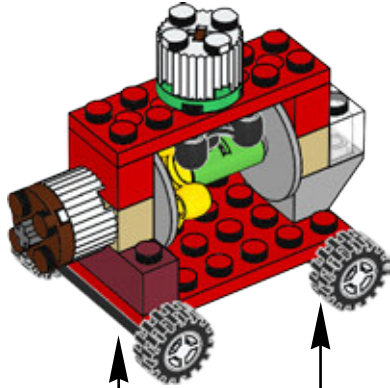



13

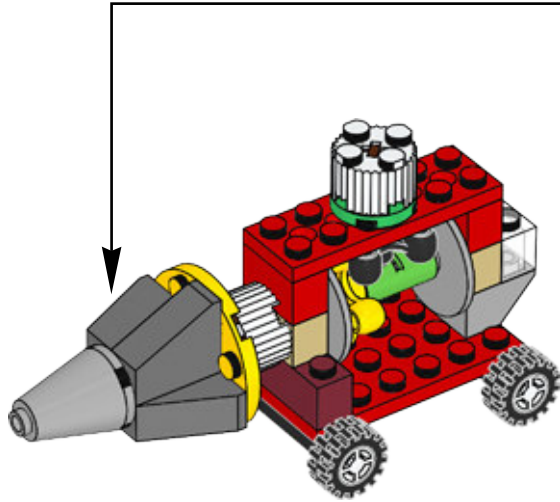
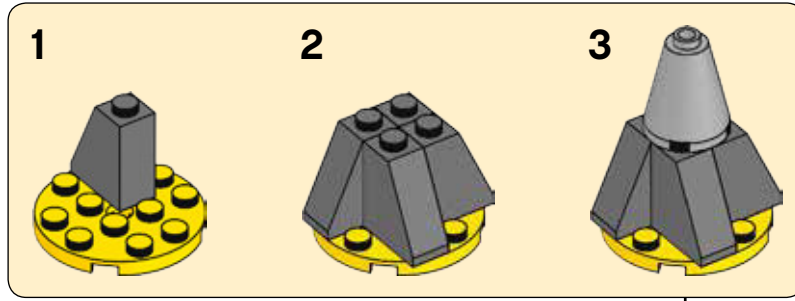



LEGO and the LEGO logo are trademarks of the/sont des marques de commerce du/son marcas registradas de LEGO Group. ©2018 The LEGO Group.



**CLASSIC**



**10712**



Warning! Choking hazard. Small parts.  
Achtung! Erstickungsgefahr. Kleine Teile.  
Attention ! Danger d'étouffement. Petits éléments.  
Avvertenza! Rischio di soffocamento. Piccole parti.  
Waarschuwing! Verstikkingsgevaar. Kleine onderdelen.  
¡Advertencia! Peligro de atragantamiento. Partes pequeñas.  
Advarsel! Kvælningsfare. Små dele.  
Viðvörðun! Kófnunarhætta. Litlir hlutir.  
Varoitus! Tukehtumisvaara. Pieniä osia.  
Varning! Kvävningrisk. Små delar.  
Advarsel! Kvelningsfare. Små deler.  
Atenção! Risco de asfixia. Pequenas partes.  
Προειδοποίηση! Κίνδυνος πνιγμού. Μικρά μέρη.  
警告! 小部品があります。誤飲・窒息の危険があります。  
警告! 小心窒息。当心小物件。  
경고! 질식 위험. 작은 부품 포함.  
Внимание! Риск удушения. Мелкие детали.  
Ostrzeżenie! Niebezpieczeństwo udławienia się. Małe części.  
Upozornění! Nebezpečí zalknutí. Malé části.  
Upozornenie! Nebezpečenstvo dusenia. Malé časti.  
Figyelmeztetés! Fulladásveszély. Kis alkatrészek.  
Ποпередження! Ризик задухи. Дрібні деталі.  
Urozorenje! Opasnost od gušenja. Mali dijelovi.  
Упозорење! Опасност од гушења. Мали делови.  
Предупредување! Опасност од задушвање. Мали делови.  
Orozorilo! Nevarnost zadušitve zaradi tujka. Majhni deli.  
Avertisment! Pericol de sufocare internă. Părți mici.  
Внимание! Опасност от задавяне. Малки части.  
Brīdinājums! Aizrīšanās risks. Sīkas detaļas.  
Hoiatus! Kägistamisohu. Väikesed osad.  
İspējimas! Pavojus užspringti. Smulkios detalės.  
Uyarı! Boğulma Tehlikesi (Havasızlıktan). Küçük Parçalar.  
تحذير! خطر الاختناق. أجزاء صغيرة.  
Peringatan! Bahaya tersedak. Bagian kecil.  
Amaran! Bahaya tercekik. Bahagian kecil.



**WARNING: CHOKING HAZARD.**  
Small parts. Not for children under 3 years.



**AVERTISSEMENT : RISQUE D'ÉTOUFFEMENT.**  
Contient des petites pièces. Ne convient pas aux enfants de moins de 3 ans.



**ADVERTENCIA: PELIGRO DE ASFIXIA.**  
No recomendado para niños menores de 3 años. Contiene piezas pequeñas.

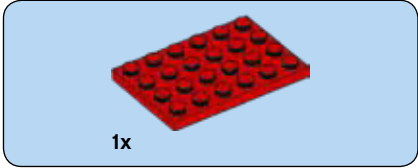
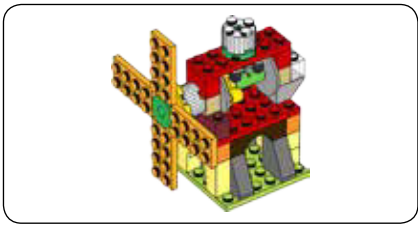

1

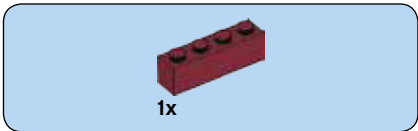

2

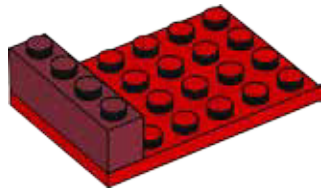

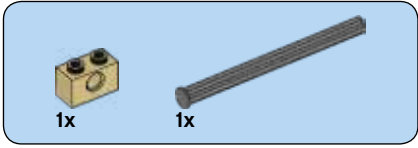
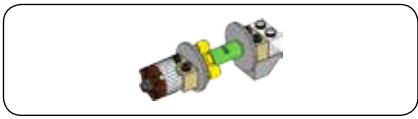

3

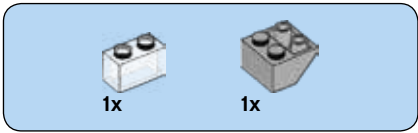
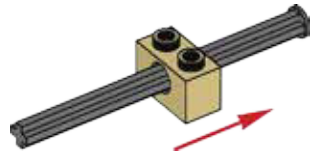

4

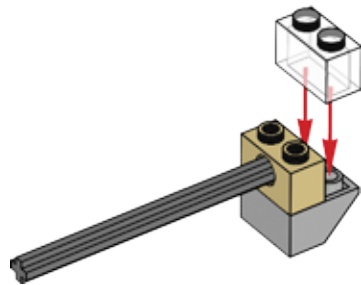

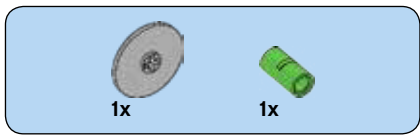

5

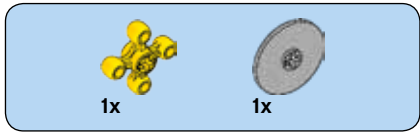
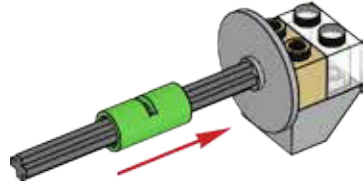

6

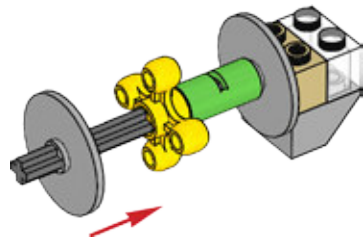





7

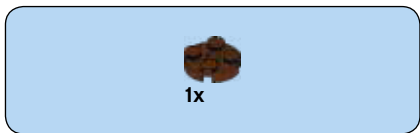
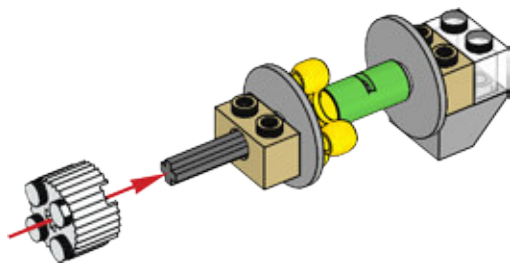

8

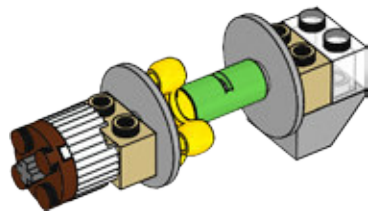

9

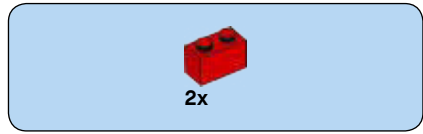
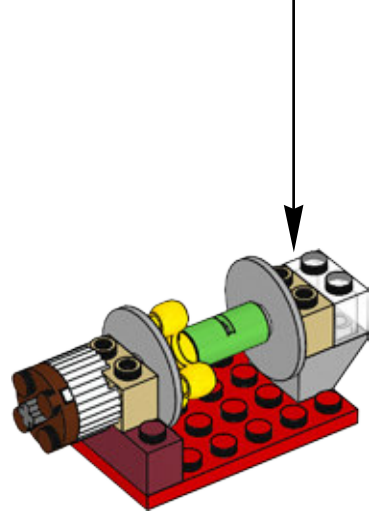

10

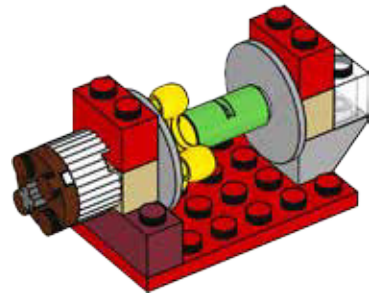

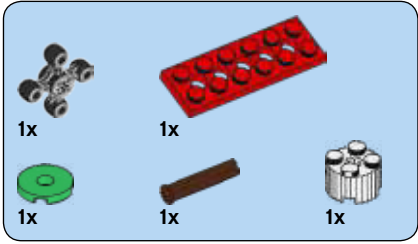

# 11

1

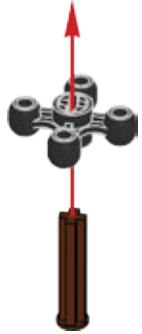

2

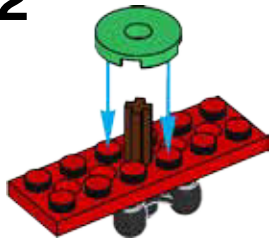

3

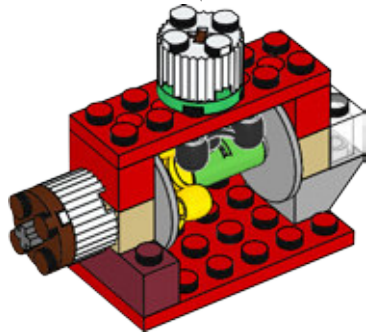
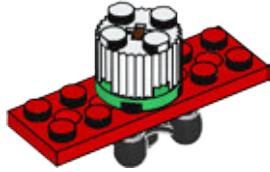

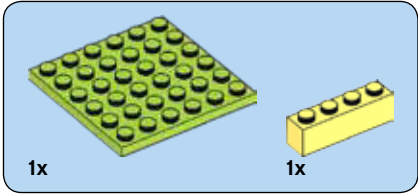
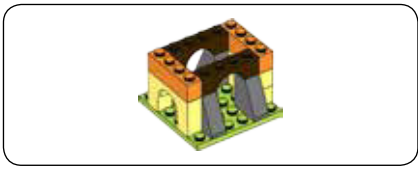

12

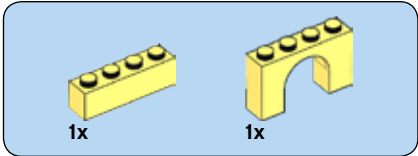
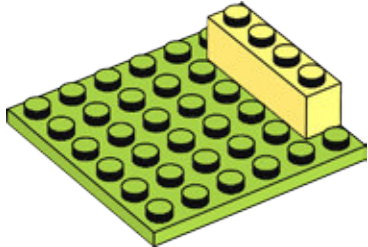

13

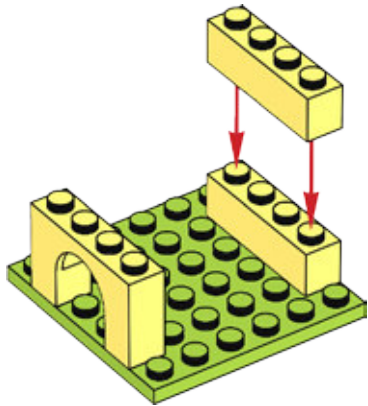

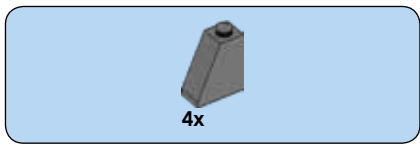

14

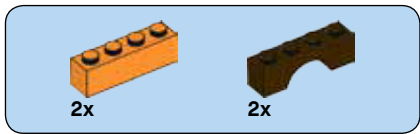
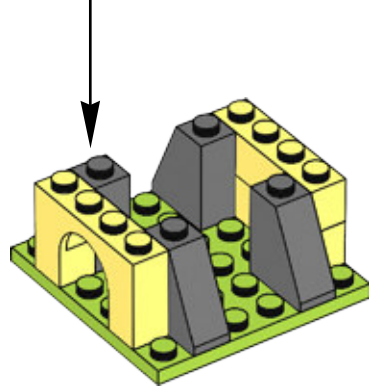

15

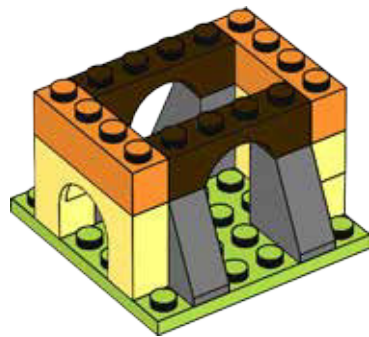

16

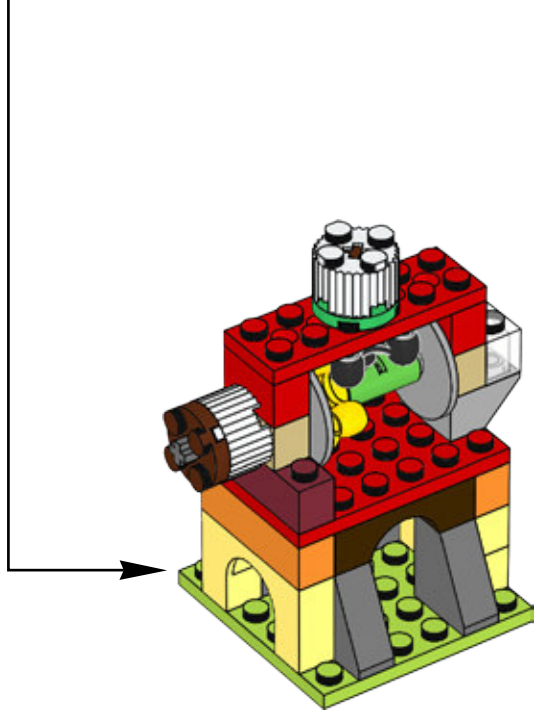

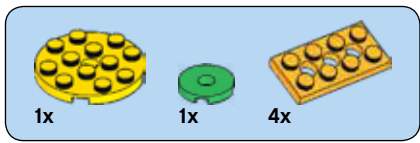

17

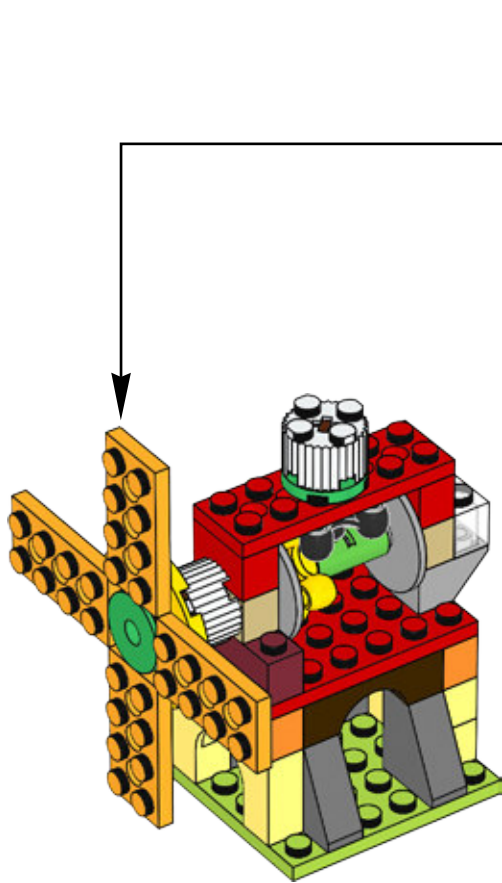
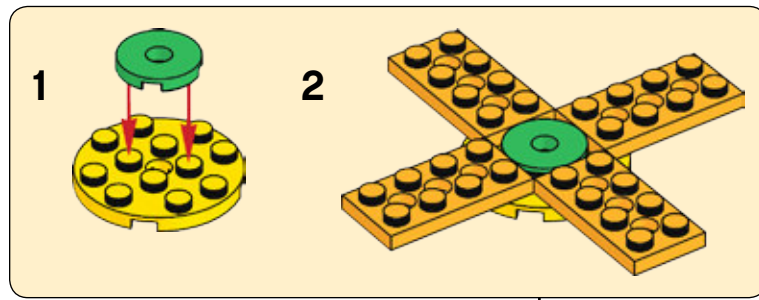





LEGO and the LEGO logo are trademarks of the/sont des marques de commerce du/son marcas registradas de LEGO Group. ©2018 The LEGO Group.