



# CLASSIC

11003





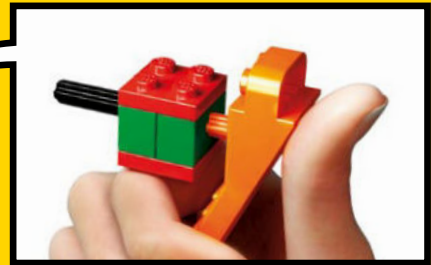
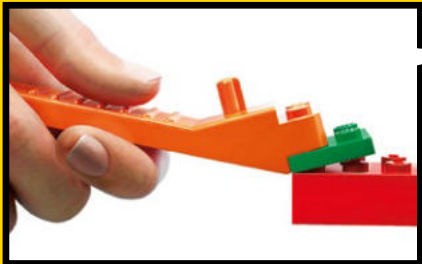

[LEGO.com/brickseparator](https://www.LEGO.com/brickseparator)



Easy building  
Einfach zu bauen  
Construction facile  
Costruzione facile  
Construcción fácil  
Construção fácil  
Kezdő építőknek  
Vienkarša būvēšana  
简单拼砌

Page  
7



Page  
12



Medium building  
Mittelschwer  
Construction intermédiaire  
Costruzione media  
Construcción intermedia  
Construção intermédia  
Gyakorló építőknek  
Vidēji sarežģīta būvēšana  
中级拼砌



Page  
20



Page  
30



Page  
Seite  
Page  
Pagina  
Página  
Página  
Oldalszám  
Lpp.  
页码





Page  
**40**



Advanced building  
Fortgeschritten  
Construction avancée  
Costruzione avanzata  
Construcción avanzada  
Construção avançada  
Tapasztalt építőknek  
Sarežgita būvēšana  
高级拼砌



Page  
**51**



Page  
**63**

## More Ideas Online



Weitere Ideen online:  
Plus d'idées en ligne :

Più idee online:

Más ideas en Internet:

Mais ideias online:

Online még több ötletet találsz:

Vairāk ideju tiešsaistē:

更多在线构思:



 [LEGO.com/classic](https://www.LEGO.com/classic)

1



2



3

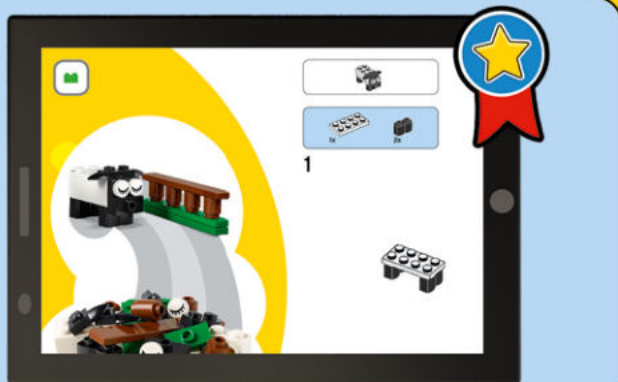

## LEGO.com/apps

Check for compatibility

Kompatibilität prüfen

Vérifier la compatibilité

Controlla la compatibilità

Comprueba tu compatibilidad

Verificar a compatibilidade

Ellenőrizd a kompatibilitást

Pārbaudīt saderību

检查兼容性



1x



2x

1

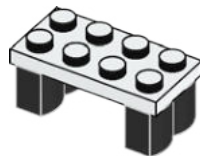

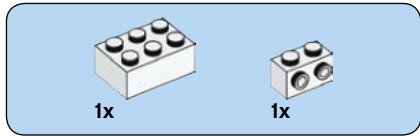

2

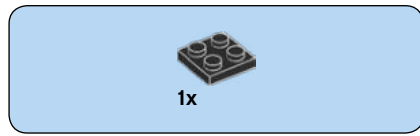
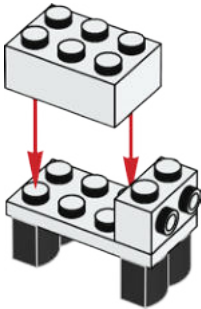

3

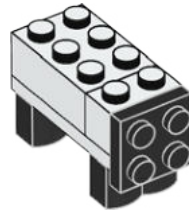





1x



2x

4

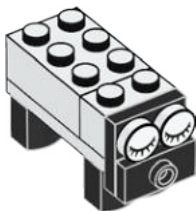

2x

5



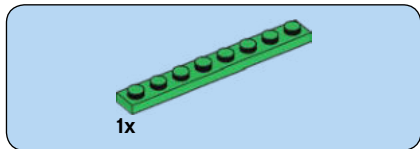
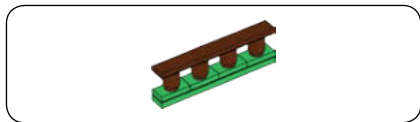

6

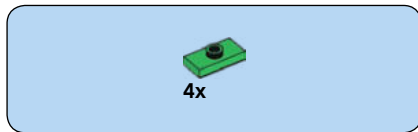
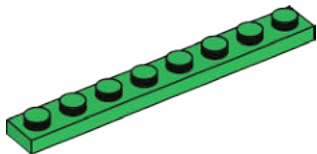

7

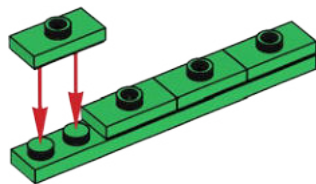

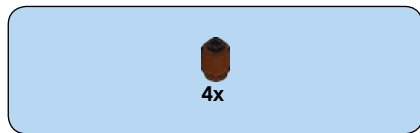

8

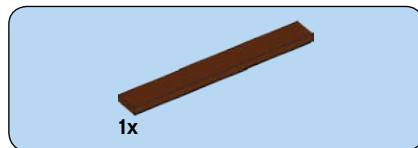
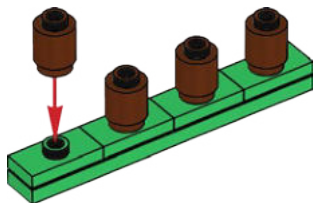

9

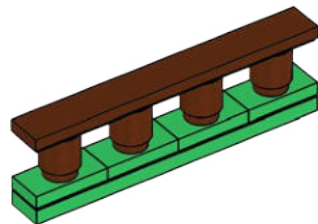

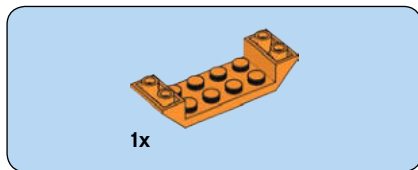

1

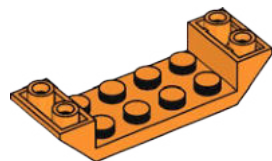



4x

2

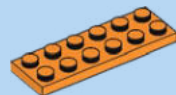
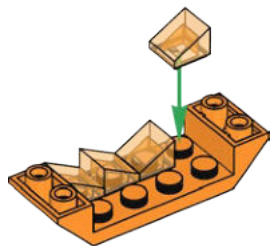

1x

3

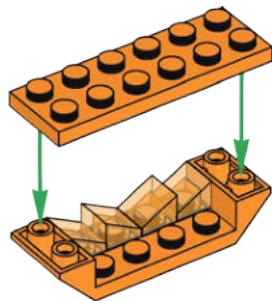



1x



1x

4

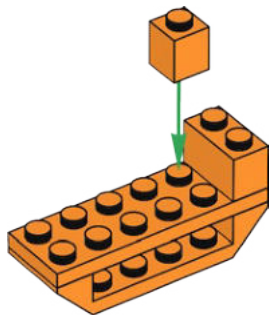



2x

5

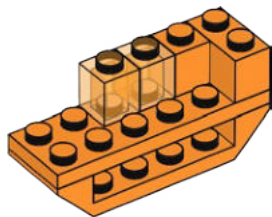

1x



1x

6

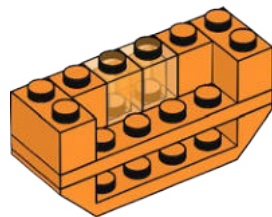



2x

7

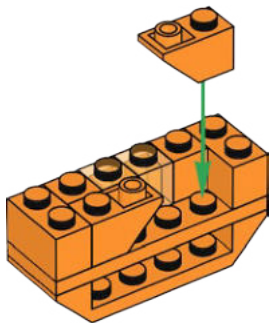



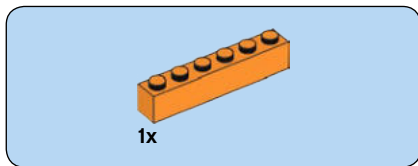

8

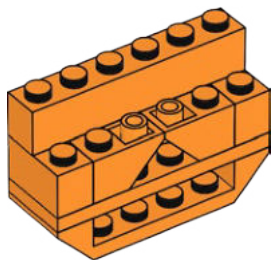

9

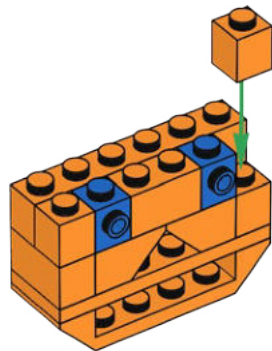

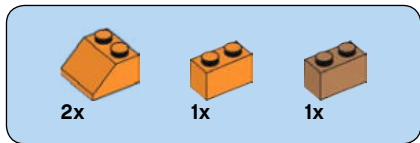

10

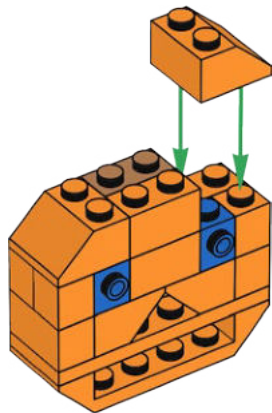



1x



1x

11

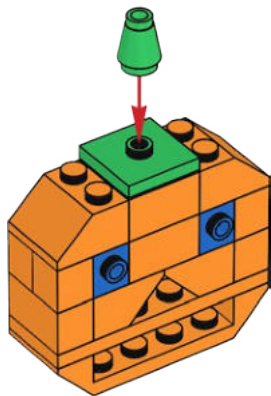

1x

12

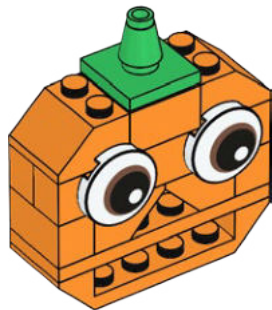



1



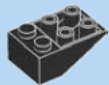

2x

2

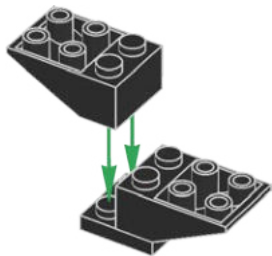

2x

3

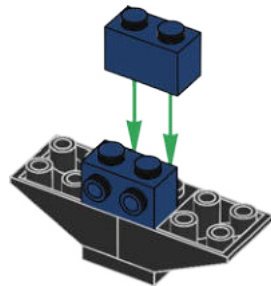



2x

4

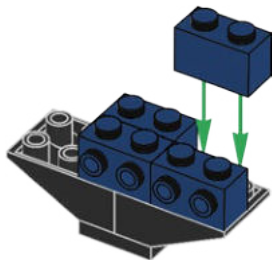



2x

5

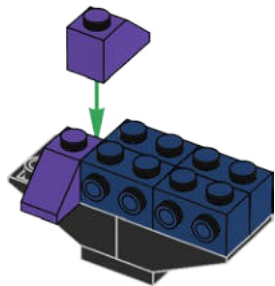

1x

6

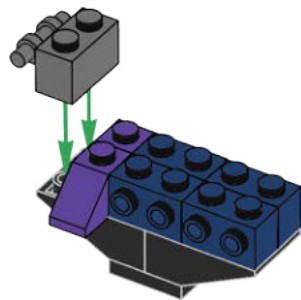



2x

7

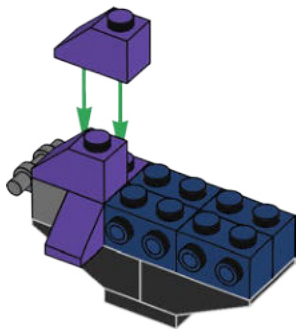



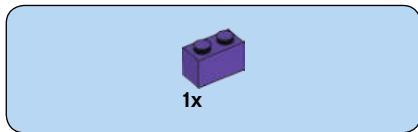

8

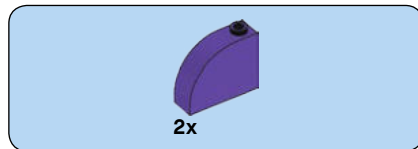
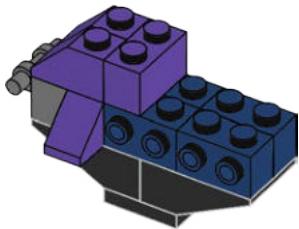

9

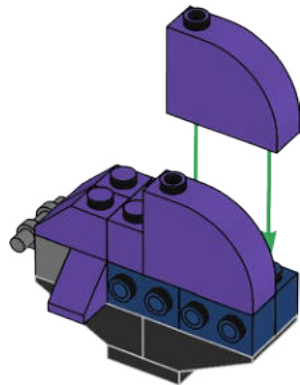



2x

10

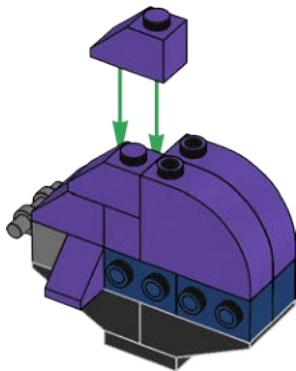



1x



1x

# 11

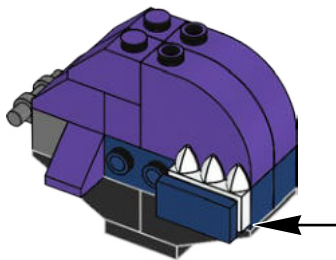
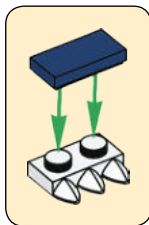

1x



1x

# 12

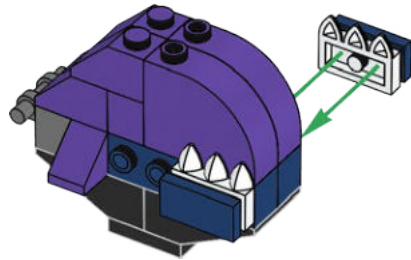
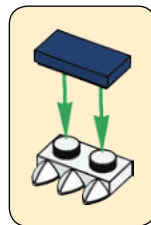

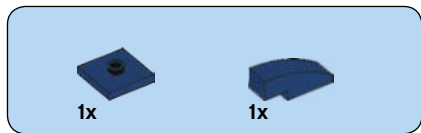

13

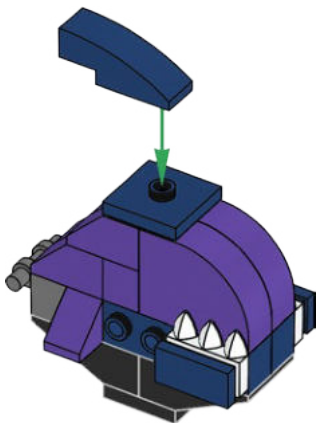



14

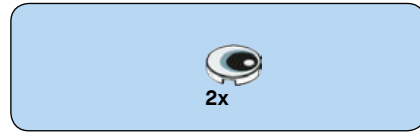
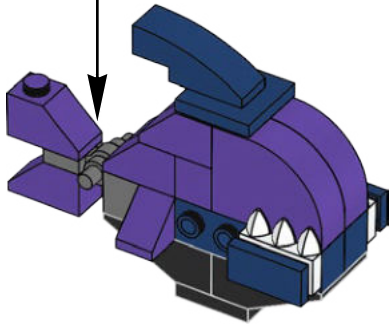
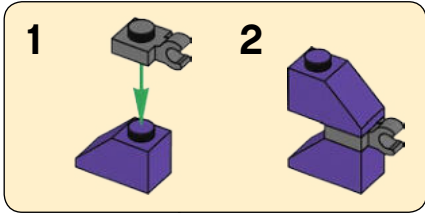

15

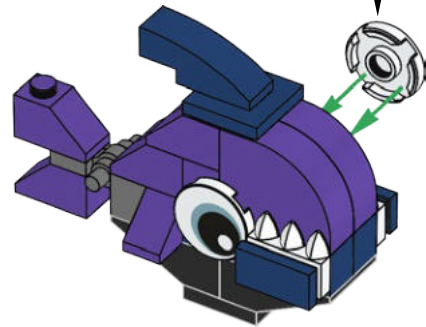



1x

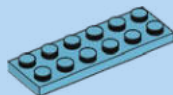

1x

1

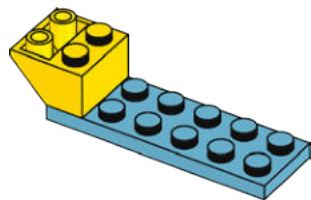



2x

2

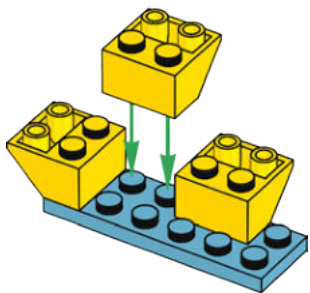

2x

3

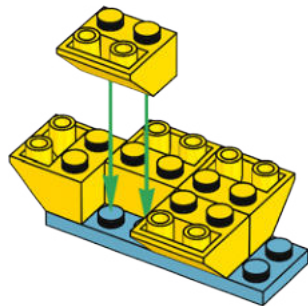



1x

4

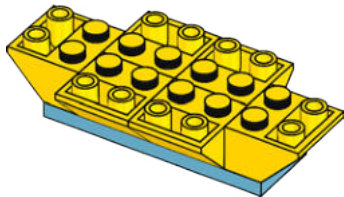



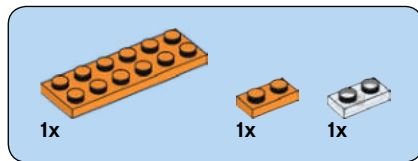

5

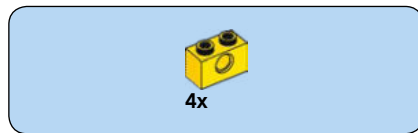
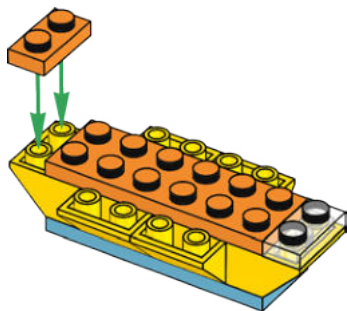

6

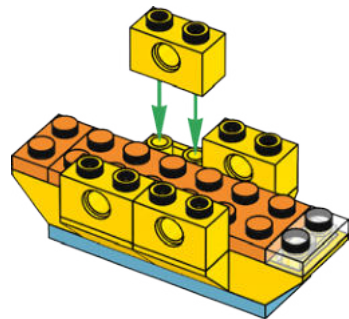

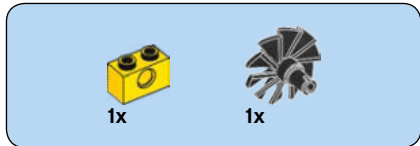

7

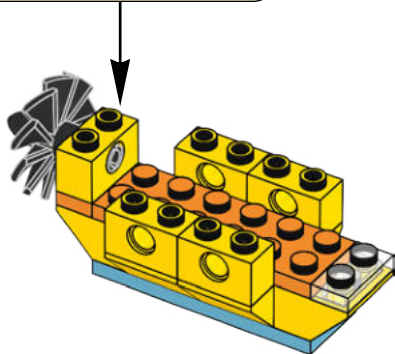
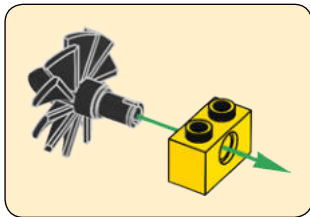

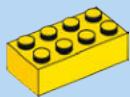

1x

8

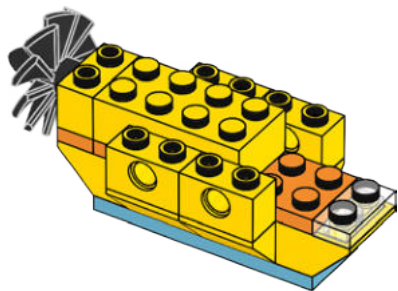

1x



1x

9

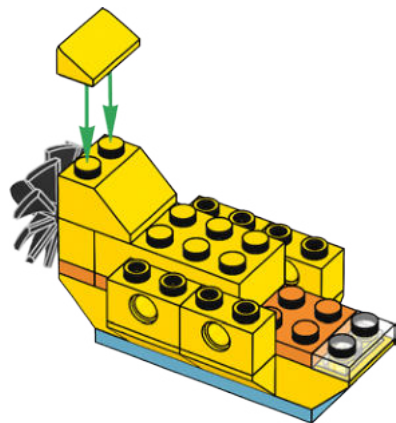



1x



1x

# 10

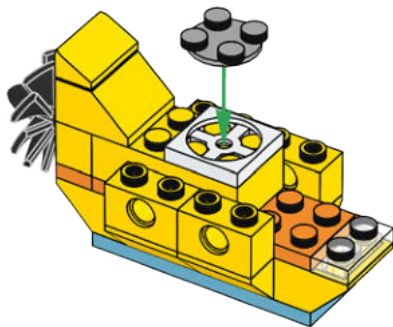



2x

11

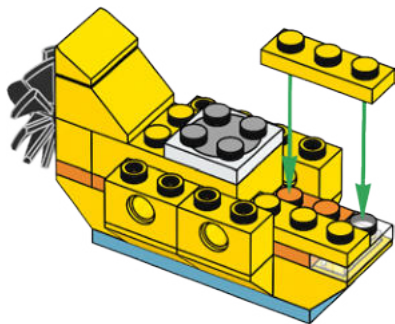

1x

12

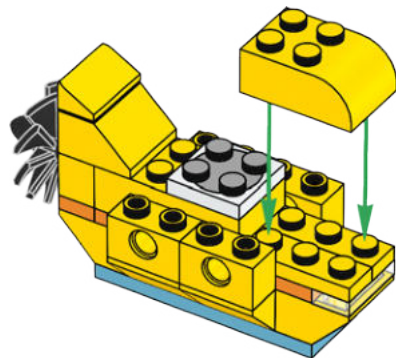



2x

13

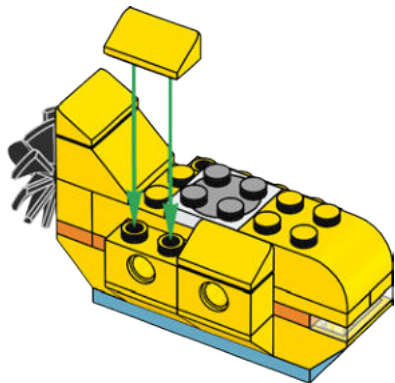

2x

14

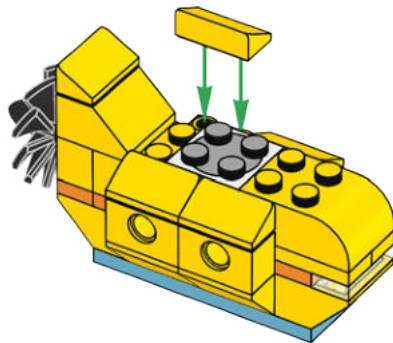



1x



1x

# 15

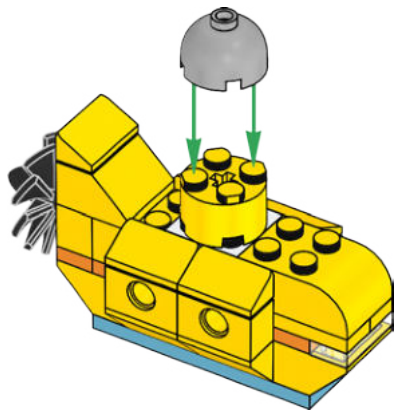

1x



1x



1x

# 16

1



2

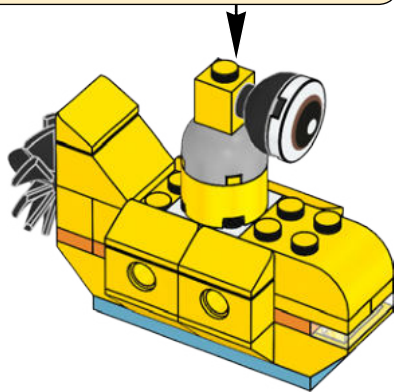

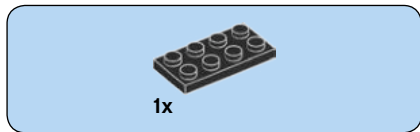

1

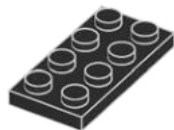



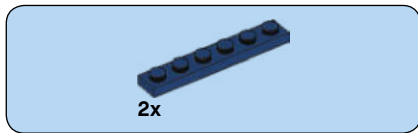

2

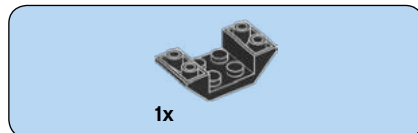
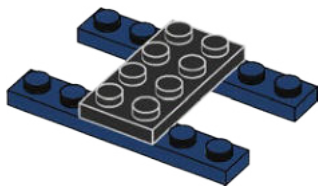

3

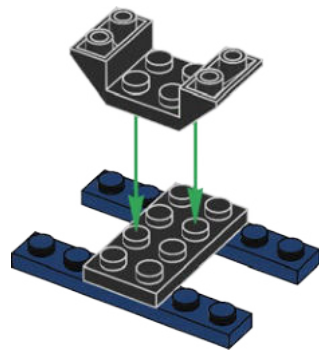



2x

4

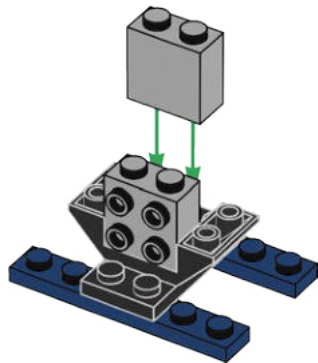



2x



1x

5

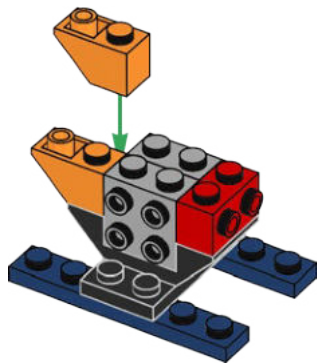

2x

6

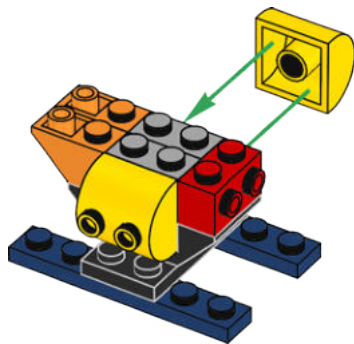

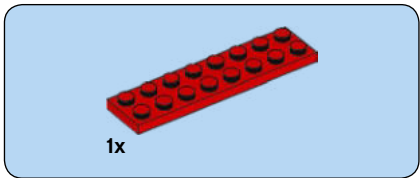
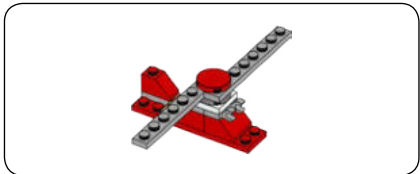

7

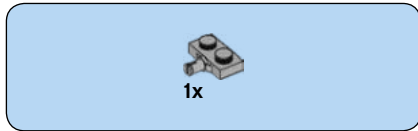
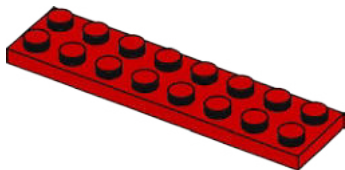

8

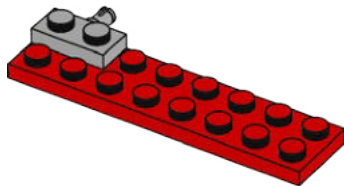



1x



1x

9

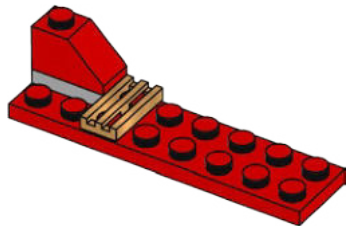

2x

10

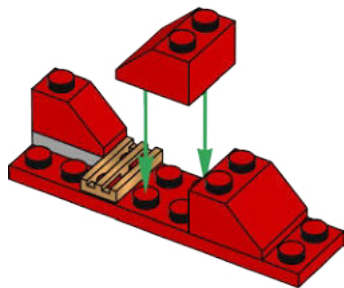



2x



1x

# 11

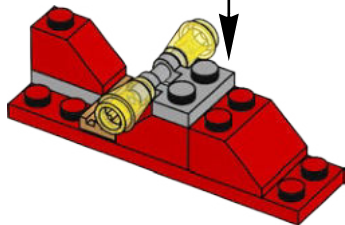
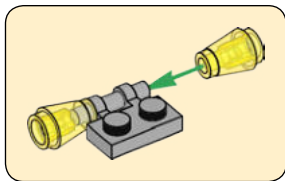

1x

# 12

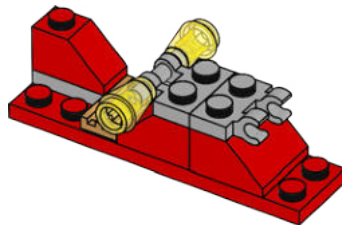



1x



1x

# 13

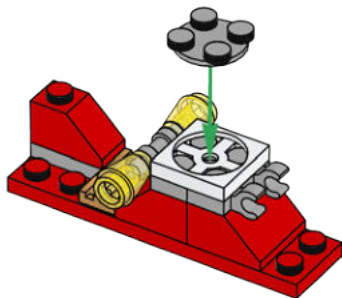

1x

# 14

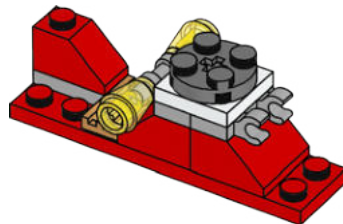

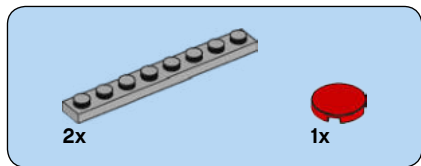

15

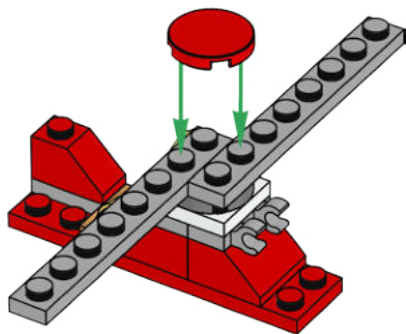

16

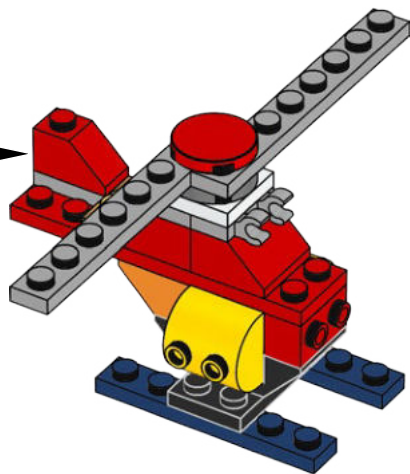





2x

17

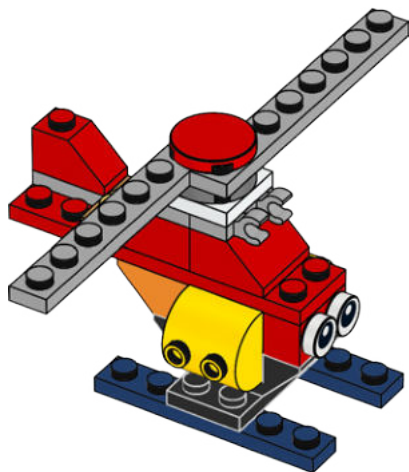

1x



1x

18

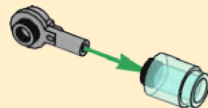
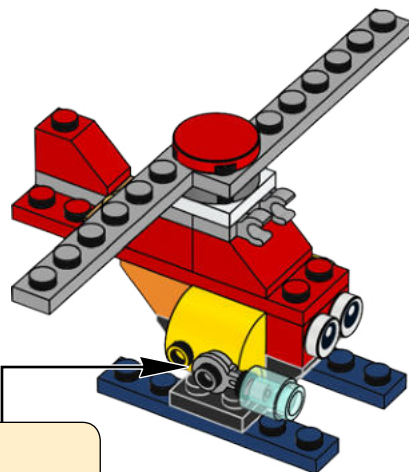



19

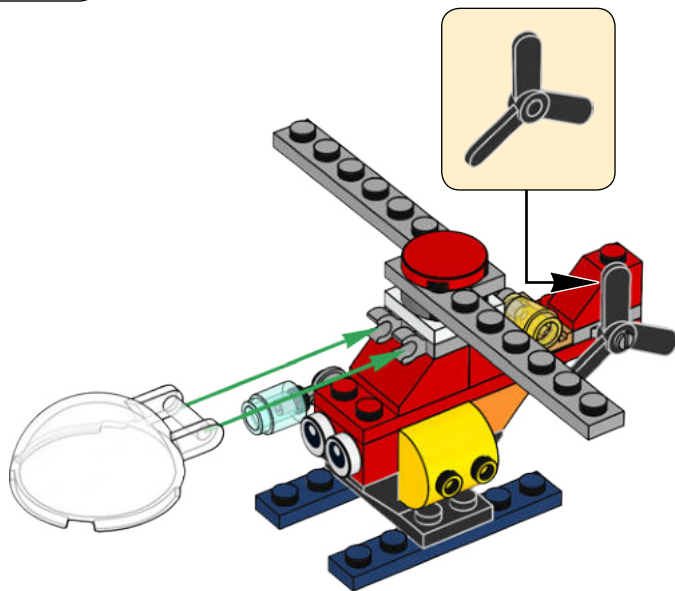

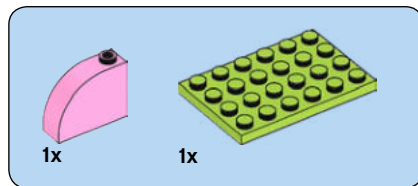

1

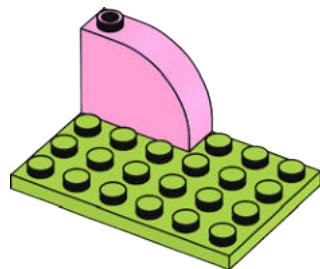



2x

2

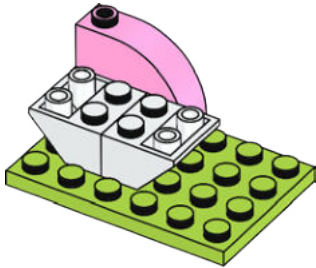

1x



1x

3

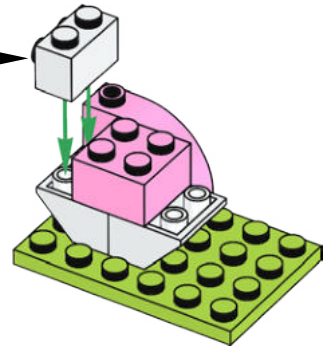
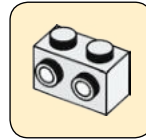

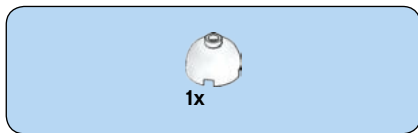

4

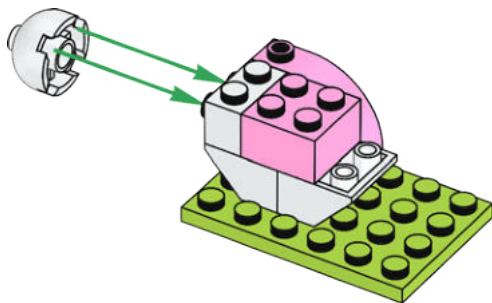

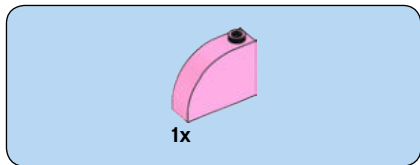

5

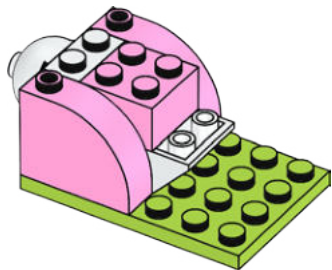

6

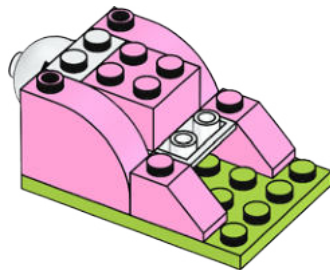



2x

7

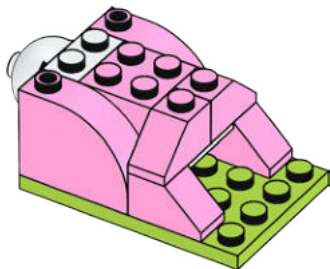

2x

8

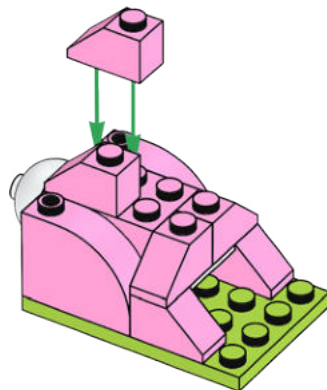

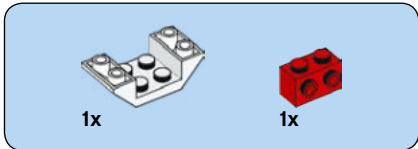
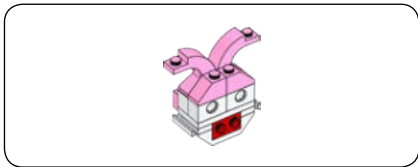

9

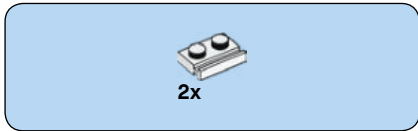
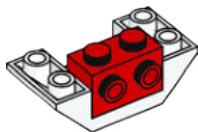

10

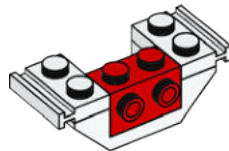





1x

11

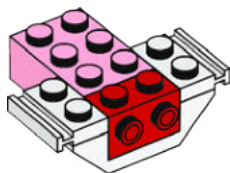

1x

12

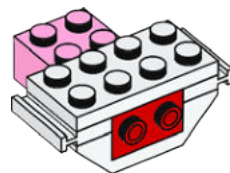



4x

13

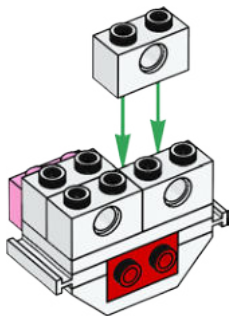

2x



1x

14

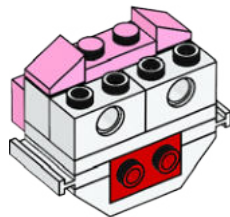

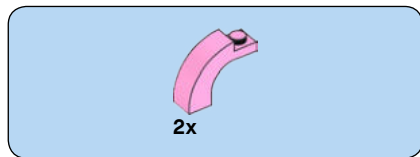

15

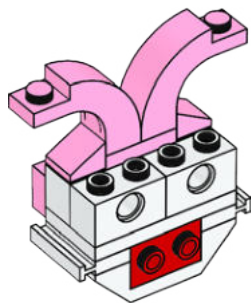

16

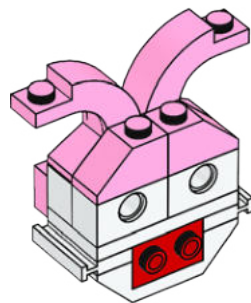

17

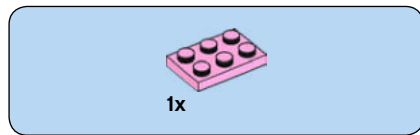
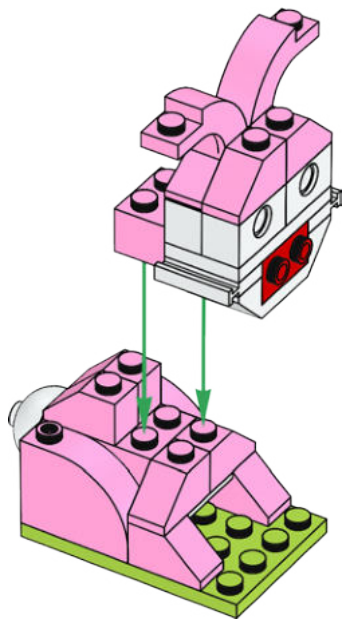

18

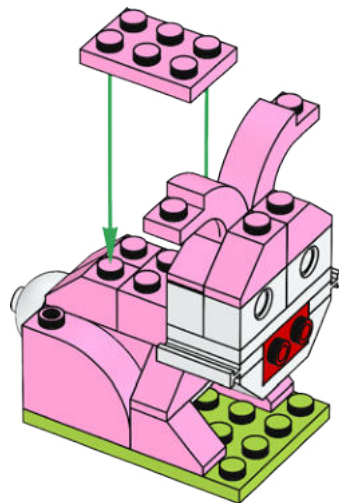



19

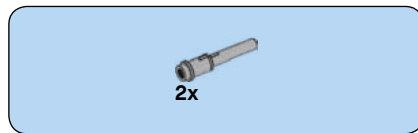
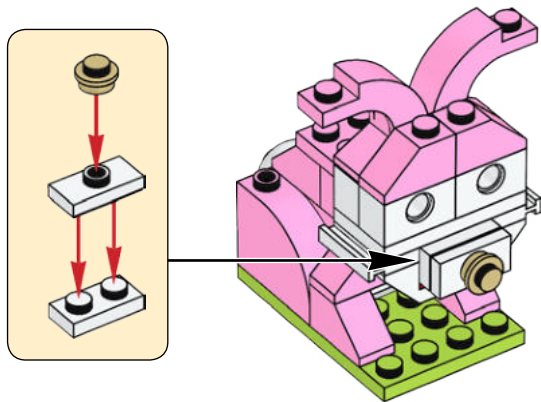

20

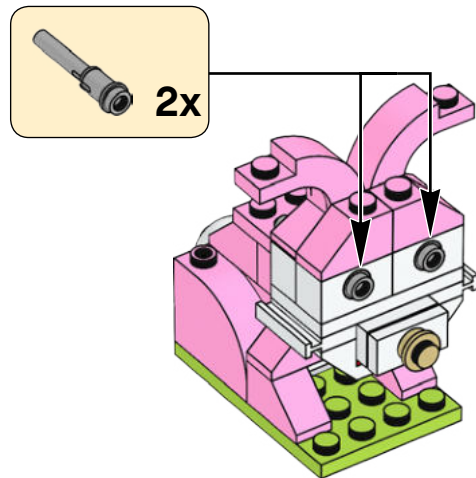



2x

21

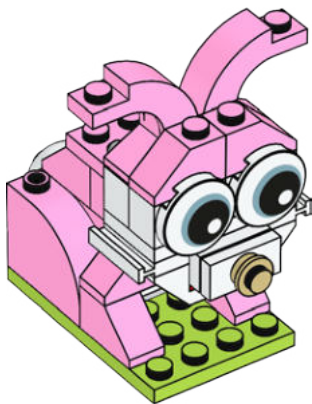

2x



1x

22

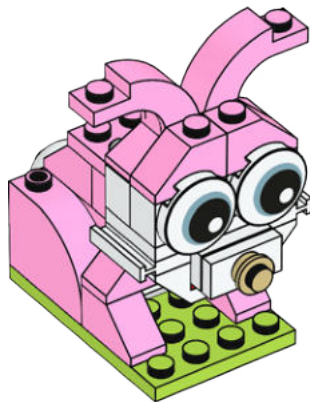

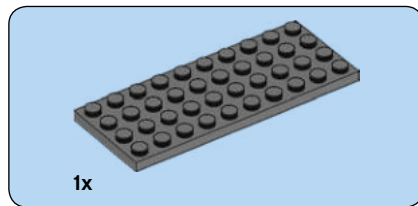

1x

1

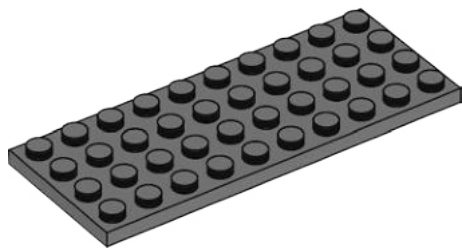



3x

2

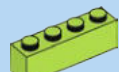
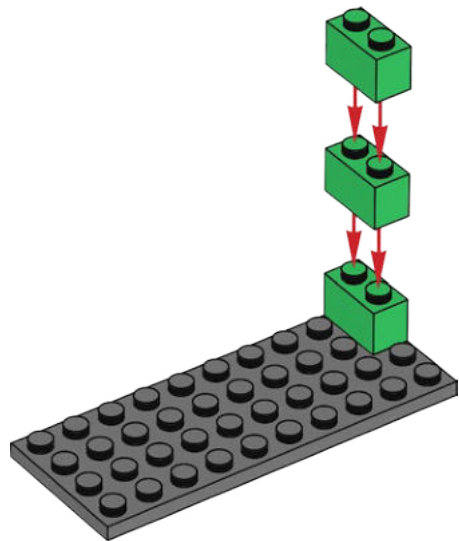

3x

3

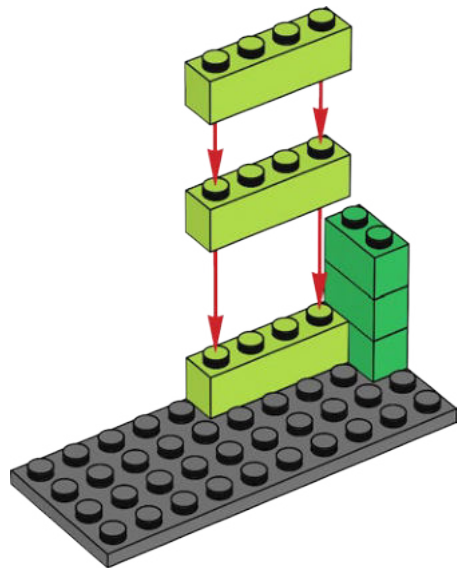



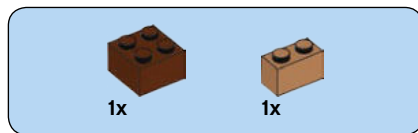

4

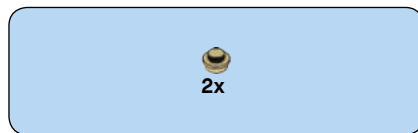
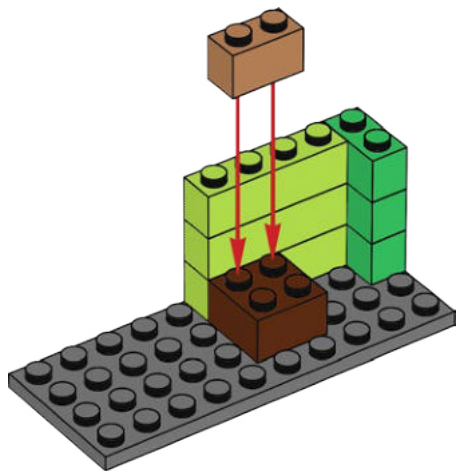

5

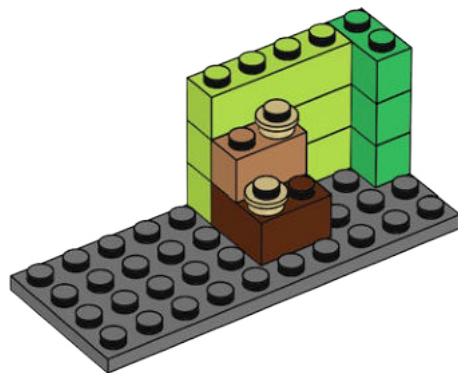

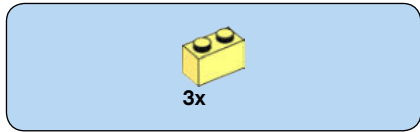

6

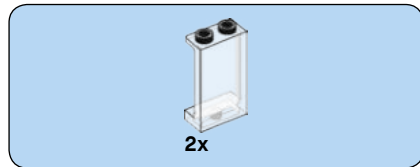
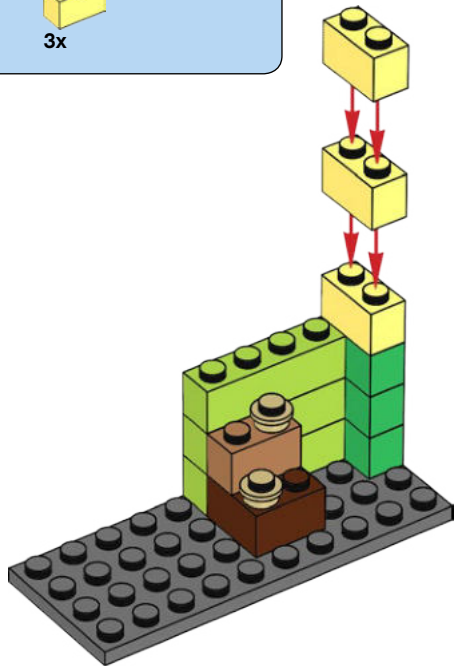

7

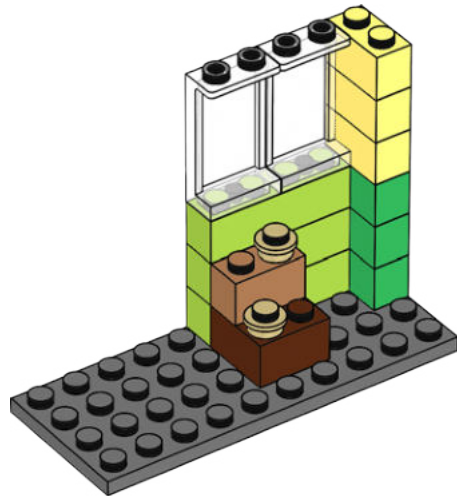

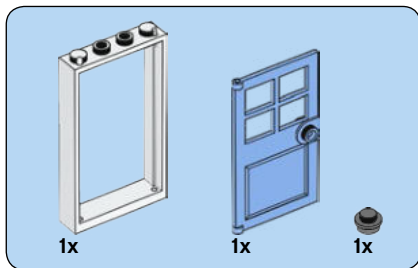

8

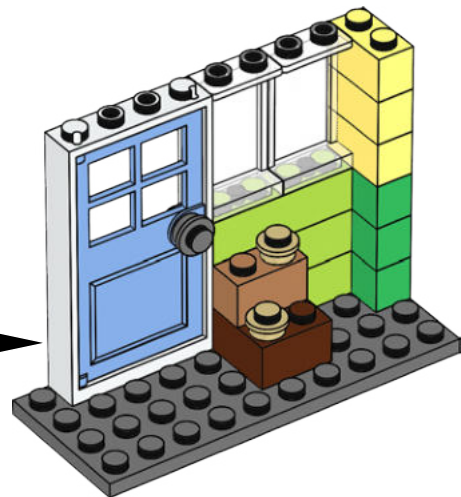
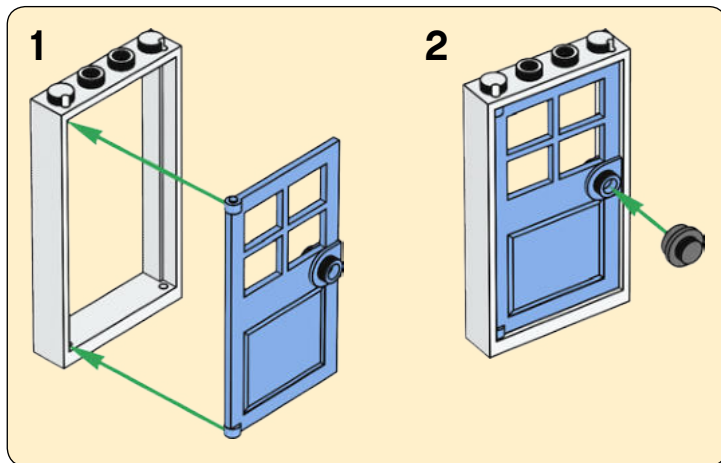



1x

9

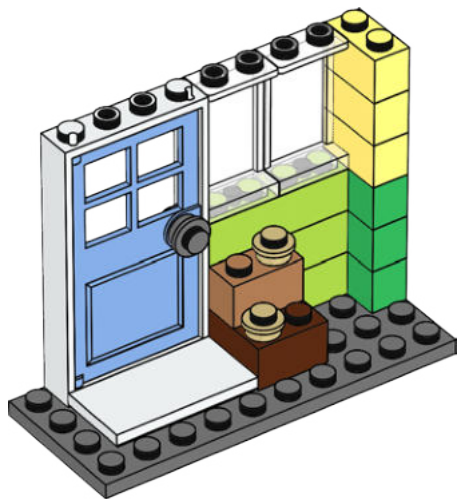

3x

10

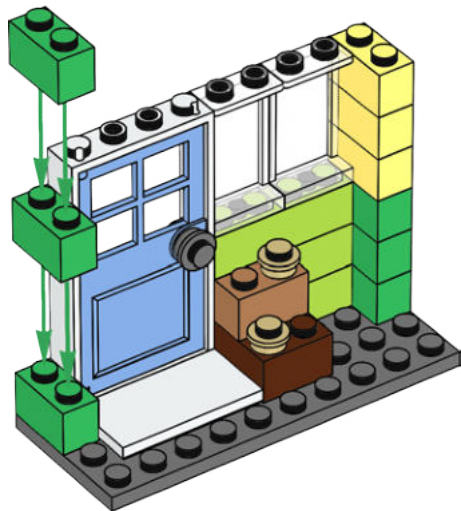



3x

11

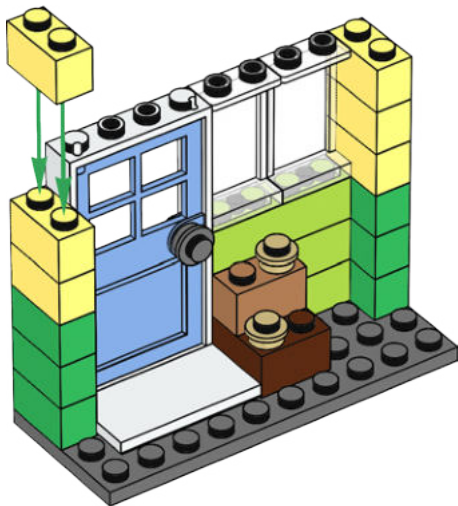

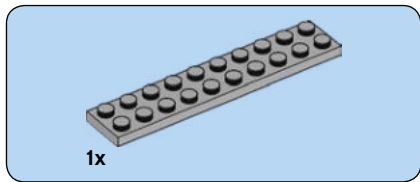

12

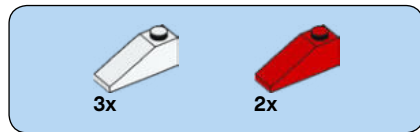
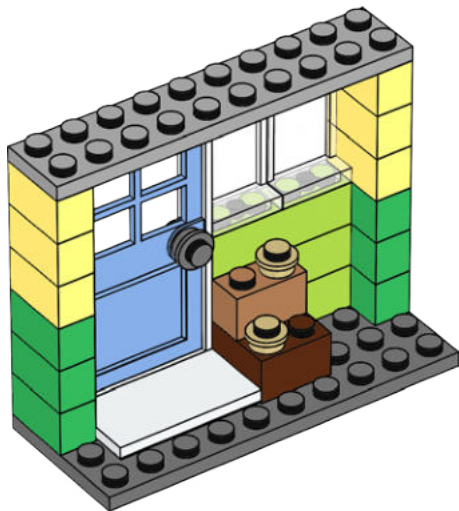

13



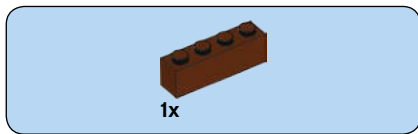

14

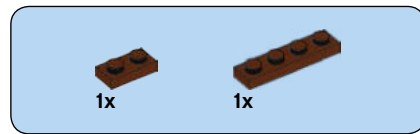

15





2x

16

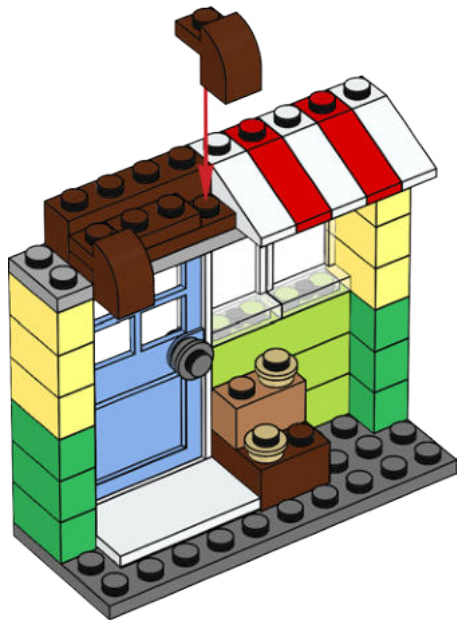

1x

17

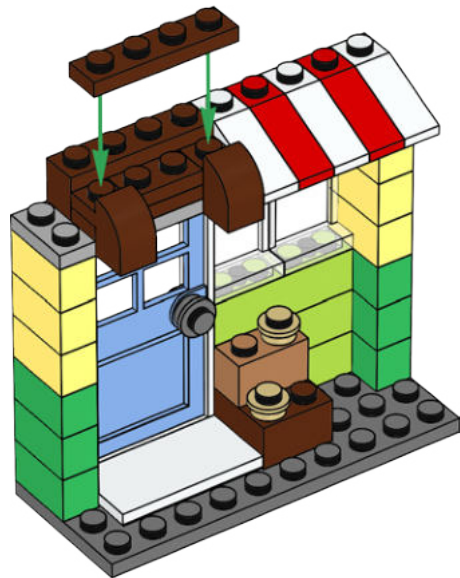





1x

18

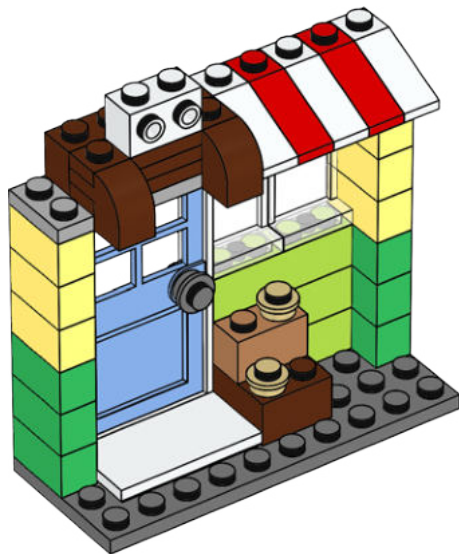

2x

19

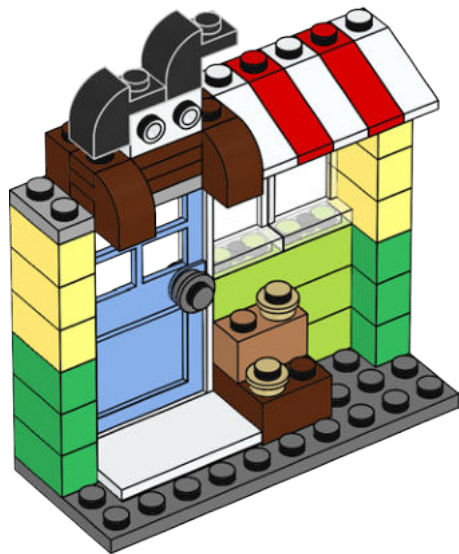

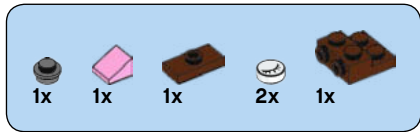

20

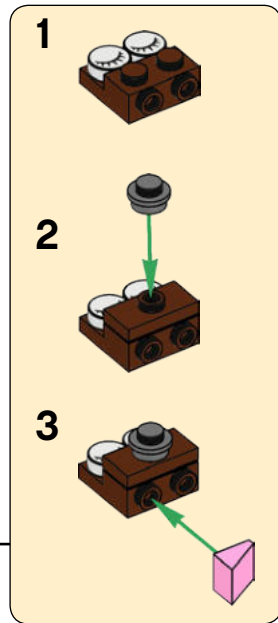
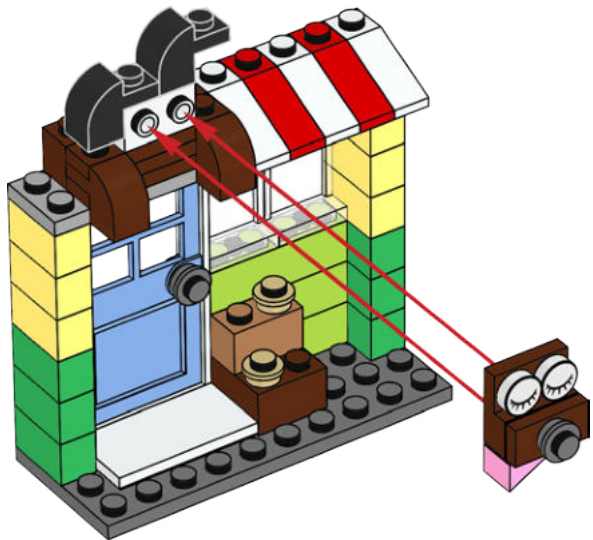



1x

21



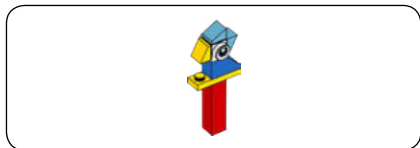

22

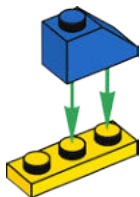

23

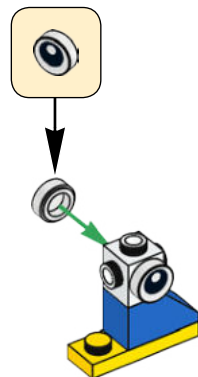

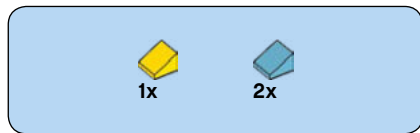

24

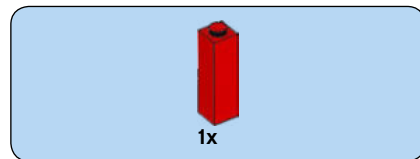
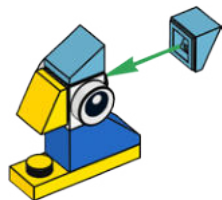

25

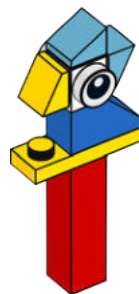

26

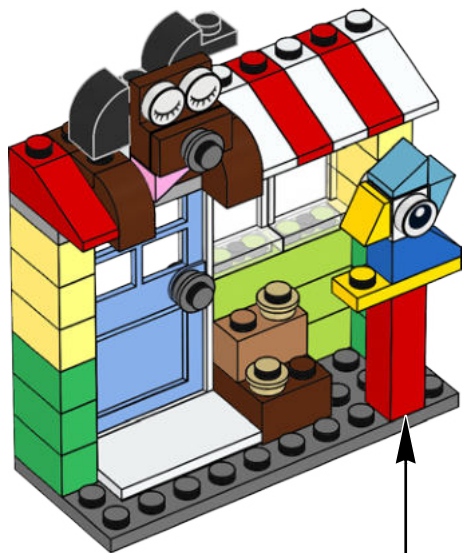



1



2



3

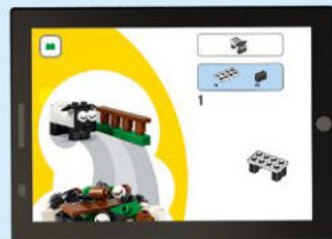



# CLASSIC



10698



10696



10700



10714



11002















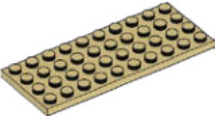















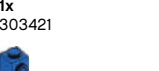





















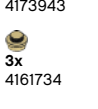







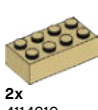











10713

10701



[LEGO.com/classic](https://www.lego.com/classic)



 2x 306201	 2x 6051511	 2x 329801	 1x 6037834	 4x 300121	 4x 4624985	 1x 621524	 4x 6184784
 3x 6173629	 1x 302301	 1x 4541956	 1x 6061700	 1x 303421	 1x 4504381	 2x 4164073	 1x 6088638
 3x 6099548	 4x 6046381	 2x 302001	 1x 6066342	 1x 303421	 6x 4550348	 2x 300124	 1x 6170693
 7x 6029156	 2x 4249563	 2x 302001	 2x 6019155	 4x 4583862	 4x 614324	 3x 307026	 4x 4568644
 7x 6097402	 3x 368001	 2x 4560178	 4x 4121934	 4x 300423	 5x 370024	 2x 4273590	 2x 302226
 2x 4111971	 1x 6047220	 2x 4173943	 4x 303921	 2x 302323	 6x 366024	 2x 6102341	 4x 4582251
 4x 6252746	 4x 300301	 2x 4114319	 4x 428621	 4x 4121936	 2x 4187061	 2x 4644456	 2x 374726
 4x 6253320	 4x 366001	 2x 300201	 1x 302021	 2x 371023	 4x 303924	 2x 249626	 1x 302026
 1x 4216652	 4x 428601			 4x 300123	 3x 362324	 1x 6092585	
 4x 6058177	 4x 300201						
 4x 370001							



2x  
300126



1x  
4188534



2x  
4529239



4x  
6092586



8x  
4107736



1x  
4565321



1x  
302228



1x  
621528



1x  
371028



1x  
302028



4x  
4106356



1x  
346028



2x  
6211814



2x  
6240204



1x  
6244781



2x  
6238677



2x  
6167288



1x  
6052993



2x  
4205058



4x  
4518029



4x  
4173805



2x  
4177932



4x  
4121739



4x  
4616279



4x  
4118828



1x  
4189007



2x  
4121741



1x  
6252778

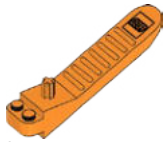

1x  
6240515



4x  
6073026



4x  
4164022



2x  
6138122



4x  
4234716



1x  
4537936



1x  
6060848



2x  
4528488



4x  
6135606



1x  
4565320



2x  
4540280



2x  
4508313



2x  
4508313



2x  
4260493



4x  
6245265



2x  
6240550



4x  
4211183



4x  
4211149



2x  
6092590



2x  
4211150



2x  
6035547



4x  
4211199



4x  
4211210



1x  
6146301



2x  
4211190



4x  
4211225



4x  
4211201



1x  
4585337



2x  
4211412



2x  
6168647



3x  
6227897



4x  
4211764



2x  
6152344



1x  
4211637



3x  
4540203



2x  
6125569



1x  
4227776



2x  
6123809



2x  
4556157



2x  
4211632



2x  
6043639

2x  
4520320

2x  
4211504

1x  
6081975

2x  
4211425

1x  
4211462

3x  
4210633

2x  
4579354

2x  
4211042

2x  
6039479

1x  
4211128

1x  
4263176

1x  
4211122

3x  
4599538

4x  
4654128

8x  
4517995

4x  
4550359

2x  
6250587

2x  
6250647

2x  
6102999

4x  
4518892

2x  
4520632

8x  
6022083

4x  
6104154

8x  
6109814

2x  
6173047

2x  
4626935

2x  
4490599

4x  
4569382

2x  
6121350

2x  
4619520

2x  
4625629

1x  
6146926

2x  
4655173



**Customer Service**

**Kundenservice**

**Service Consommateurs**

**Servicio Al Consumidor**

**LEGO.com/service or dial**



**: 00800 5346 5555**

**: 1-800-422-5346**

# WIN

GO TO [WWW.LEGO.COM/PRODUCTFEEDBACK](http://WWW.LEGO.COM/PRODUCTFEEDBACK) AND  
GIVE US YOUR SHORT **FEEDBACK** ABOUT THIS  
LEGO® SET FOR A CHANCE TO WIN  
A COOL LEGO PRIZE.

Terms & Conditions apply

## LEGO.com/productfeedback



### GEWINNE

Erzähle uns auf  
[www.LEGO.com/productfeedback](http://www.LEGO.com/productfeedback)

etwas über die Erfahrungen, die du mit  
diesem LEGO® Set gemacht hast, und  
sichere dir die Chance auf einen coolen  
LEGO Preis!

Es gelten die Teilnahmebedingungen

### GAGNE

Rends-toi sur  
[www.LEGO.com/productfeedback](http://www.LEGO.com/productfeedback)

et donne-nous quelques commentaires sur  
ce produit LEGO® pour avoir une chance  
de gagner un prix LEGO !

Voir Conditions Générales

### GANAN

Visita  
[www.LEGO.com/productfeedback](http://www.LEGO.com/productfeedback)

y envíanos tu opinión acerca de este set  
LEGO®. ¡Participarás en el sorteo de un  
premio LEGO!

Términos y Condiciones aplicables

### 获取奖品

登录  
[www.LEGO.com/productfeedback](http://www.LEGO.com/productfeedback)

给出关于此乐高®套装的简短反馈，  
就有机会获得炫酷乐高奖品

《条款及条件》适用

LEGO and the LEGO logo are trademarks of the LEGO Group. ©2019 The LEGO Group.

6280263