

# KidKraft is here to help!

If you have any issues with your item or need any assistance, please contact us.

**Email** us with the **item number**, description of the problem, **part number** and **batch code**.

(Your batch number is located on the bottom left of this sheet of paper.)

[www.kidkraft.com/assembly-instructions](http://www.kidkraft.com/assembly-instructions)

## КидКрафт здесь, чтобы помочь!

Мы делаем все возможное, чтобы обеспечить точность в каждом заказе, но иногда мы что-то упускаем.

Вот почему наша гарантия распространяется на каждую деталь продукта в течение 90 дней после покупки.

Если вам не хватает деталей или нашли какое-либо повреждение, вы можете их заменить, обратившись KidKraft.com.

Прежде чем начать, загрузите бесплатное встроенное приложение для более быстрой и легкой сборки.

[www.kidkraft.com/assembly-instructions](http://www.kidkraft.com/assembly-instructions)

## KidKraft est là pour vous aider!

Si vous avez un problème avec un article ou si vous avez besoin d'assistance, contactez-nous s'il vous plait.

Envoyez-nous un **e-mail** précisant le **numéro de référence**, la description du problème, le **numéro de référence** de la pièce et le **code de lot**.

(Votre la pièce et le code de lot est situé en bas à gauche de cette feuille.)

[www.kidkraft.com/assembly-instructions](http://www.kidkraft.com/assembly-instructions)

## KidKraft hilft Ihnen gerne!

Sie können uns jederzeit kontaktieren, falls Sie Probleme mit Ihrem Artikel haben oder sonst Unterstützung benötigen. Senden Sie uns einfach eine **E-Mail** mit der **Artikelnummer**, eine Beschreibung des Problems sowie der **Teile-** und **Chargennummer**. (Sie finden Ihre Chargennummer unten links auf dieser Seite.)

[www.kidkraft.com/assembly-instructions](http://www.kidkraft.com/assembly-instructions)

## KidKraft helpt u graag!

Neem alstublieft contact met ons op als u een probleem heeft met uw artikel of hulp nodig heeft. **Email** ons het **artikelnummer**, een omschrijving van het probleem, het **onderdeelnummer** en de **partij-code**.

(De partij-code vindt u onderaan links op deze pagina.)

[www.kidkraft.com/assembly-instructions](http://www.kidkraft.com/assembly-instructions)



**Batch Code / Código De Lote /  
La Pièce Et Le Code De Lot /  
Chargennummer / Partij-code:**





Contact Us! / Контакты

Сервисная поддержка КидКрафт на территории РФ:  
г. Москва, Лучников переулок, д. 4, стр. 2, офис 16  
[sale@kidkraft-russia.com](mailto:sale@kidkraft-russia.com)

[www.kidkraft.com](http://www.kidkraft.com)  
[customerservice@kidkraft.com](mailto:customerservice@kidkraft.com)  
1.800.933.0771  
972.385.0100

**EUROPEAN REGIONS / REGIÓN DE EUROPA / RÉGION EUROPE /  
EUROPAISCHE LANDSTRICHE / REGIO EUROPA**

KidKraft Netherlands BV  
Olympisch Stadion 29  
1076DE Amsterdam  
The Netherlands  
[www.kidkraft.com](http://www.kidkraft.com)  
[europcustomerservice@kidkraft.com](mailto:europcustomerservice@kidkraft.com)  
+31 (0)20 305 8620

**CANADA**

KidKraft  
4630 Olin Road  
Dallas, Texas 75244  
[www.kidkraft.com](http://www.kidkraft.com)  
[canadacustomerservice@kidkraft.com](mailto:canadacustomerservice@kidkraft.com)  
1.800.933.0771  
972.385.0100

**AUSTRALIA**

KidKraft  
Suite 7101,  
2 Locomotive Street  
Australian Technology Park  
Eveleigh, NSW 2015  
[www.kidkraft.com.au](http://www.kidkraft.com.au)  
[aucustomerservice@kidkraft.com](mailto:aucustomerservice@kidkraft.com)

.....

**ALL OTHER REGIONS / TOUTES LES AUTRES RÉGIONS**  
[info@kidkraft.com](mailto:info@kidkraft.com)



Item Number

Артикул









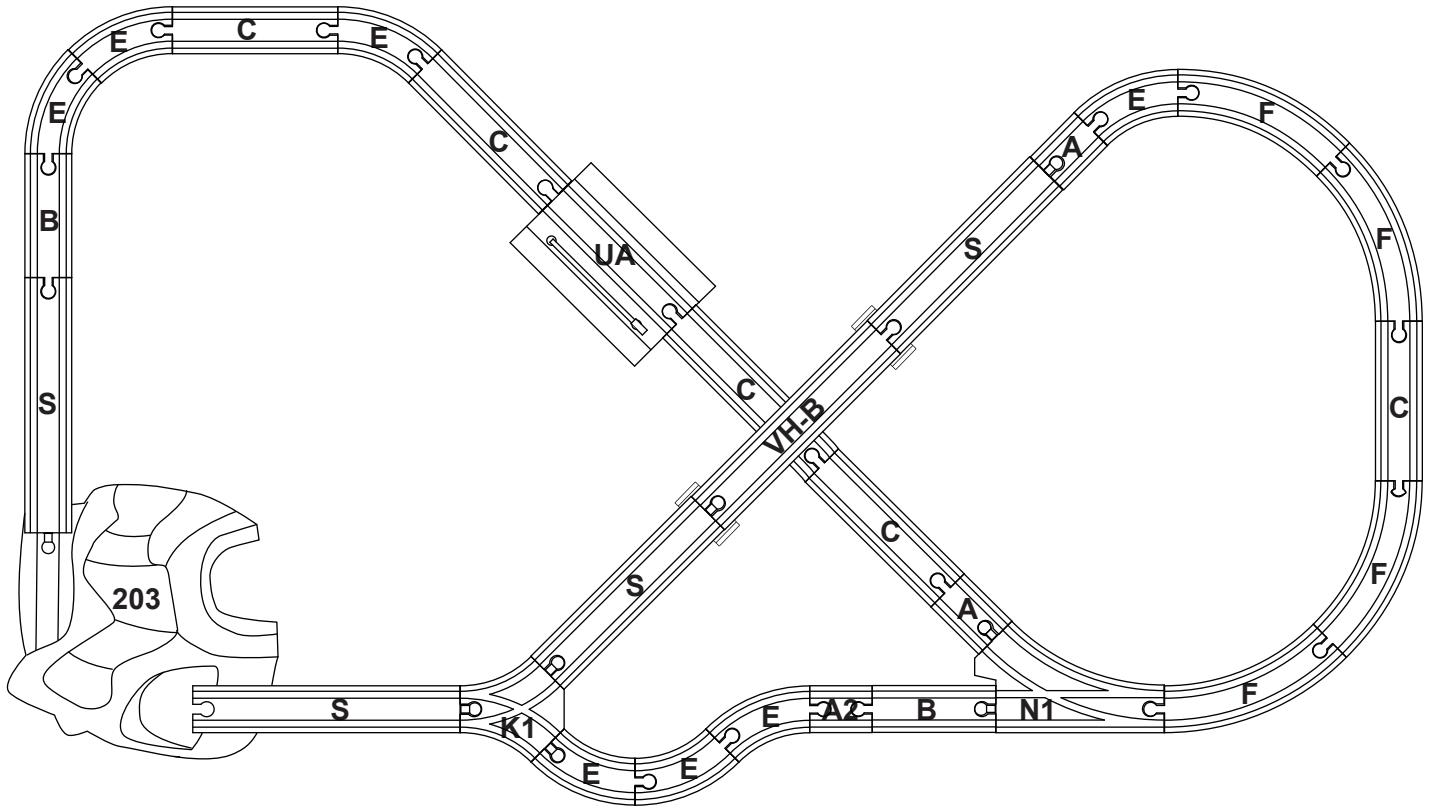

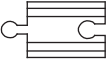

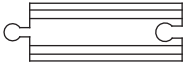
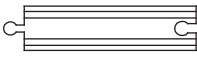
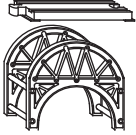

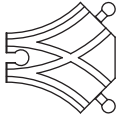
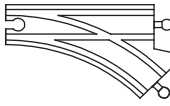
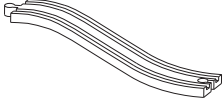
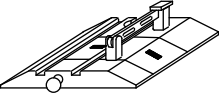
Description d'un article

Artikelnummern

Artikelnummers

17827

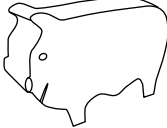
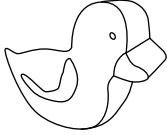
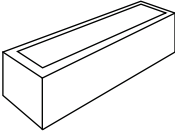
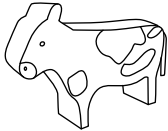

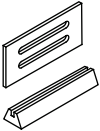
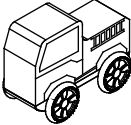
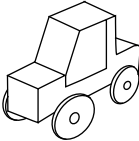
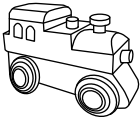
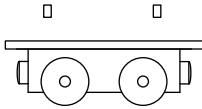
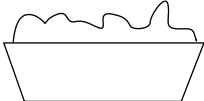
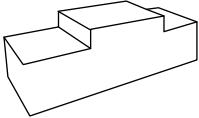
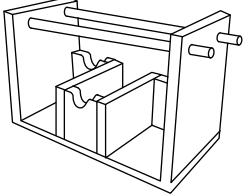
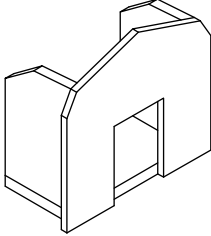
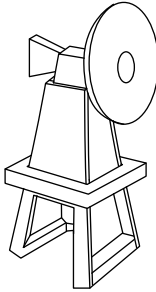
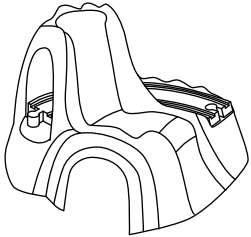
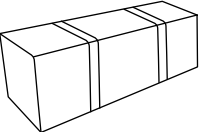
A	A2	B	C	VH- B
 x 2	 x 1	 x 2	 x 5	 x 1
E	F	K1	N1	S
 x 7	 x 4	 x 1	 x 1	 x 4
UA	201	140 A, B, C	210	101E, I, H
 x 1	 x 1	 x 1   x 1   x 1 =3	 x 5	 x 1   x 1   x 1 =3
101A	250	251	252	253
 x 1	 x 2	 x 1	 x 1	 x 1
254	255	256	257	155, C1
 x 1	 x 1	 =3	 x 1	 x 2
543B	501B	705S	800	801
 x 1	 x 1	 x 1	 x 2	 x 1
803	805	200	202	203
 x 1	 x 1	 x 1	 x 1	 x 1
 x 2				

**A** **x 1**

  
**15 mm**

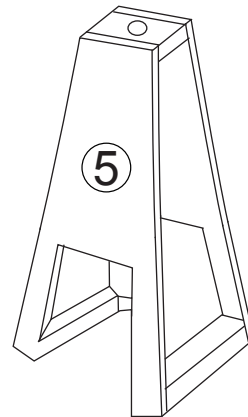
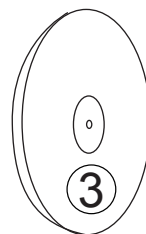
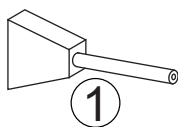

**B** **x 6**

  
**21 mm**

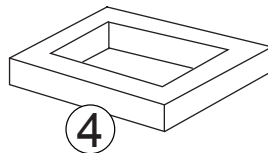
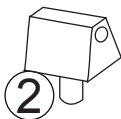

**Step**  
**Шаг**  
**Étape**  
**Schritt**  
**Stap**

**1**

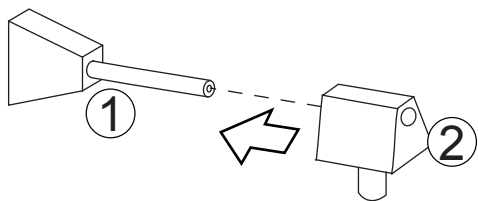

**Step**  
**Шаг**  
**Étape**  
**Schritt**  
**Stap**

**3**

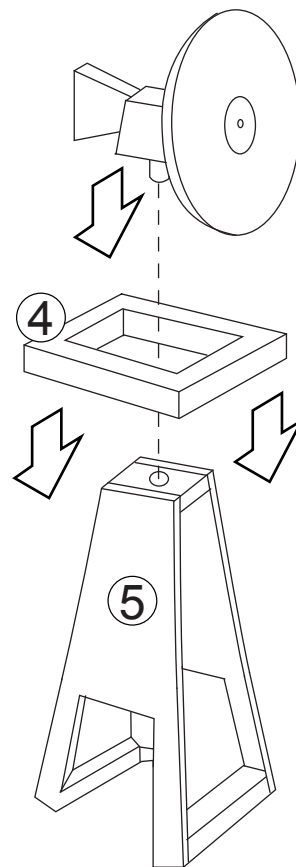

**Step**  
**Шаг**  
**Étape**  
**Schritt**  
**Stap**

**2**

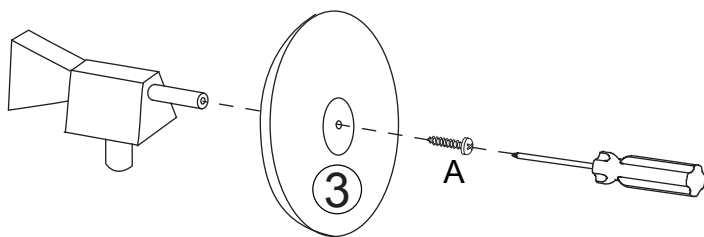

**Parts and Hardware**  
**Части и детали**  
**Pièces et Matériel**  
**Teile und Befestigungsmaterial**  
**Onderdelen en Schroeven en Gereedschap**

All hardware dimensions are approximate.  
Все размеры оборудования являются  
приблизительными



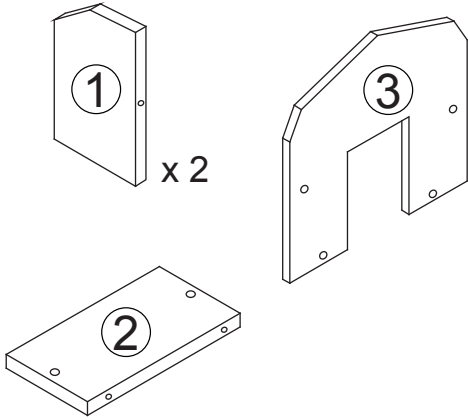

Step  
Шаг  
Étape  
Schritt  
Stap

1

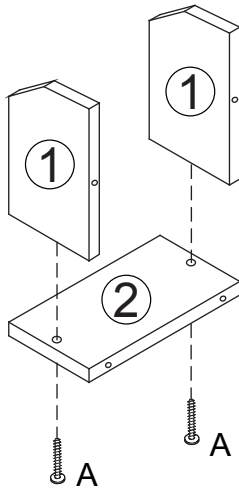

Step  
Шаг  
Étape  
Schritt  
Stap

1

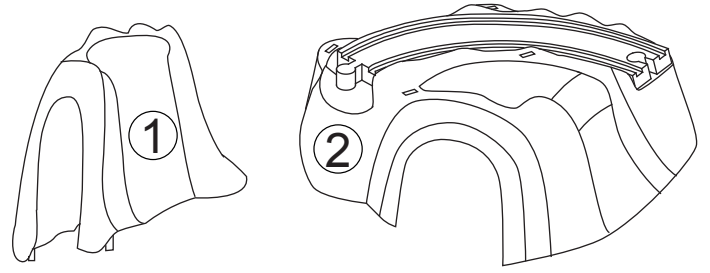

Step  
Шаг  
Étape  
Schritt  
Stap

2

