



CLASSIC



10715



Warning! Choking hazard. Small parts.
Achtung! Erstickungsgefahr. Kleine Teile.
Attention ! Danger d'étouffement. Petits éléments.
Avvertenza! Rischio di soffocamento. Piccole parti.
Waarschuwing! Verstikkingsgevaar. Kleine onderdelen.
¡Advertencia! Peligro de atragantamiento. Partes pequeñas.
Advarsel! Kvælningsfare. Små dele.
Viðvörðun! Kófnunarfættta. Litlir hlutir.
Varoitus! Tukehtumisvaara. Pieniä osia.
Varning! Kvävningrisk. Små delar.
Advarsel! Kvelningsfare. Små deler.
Atenção! Risco de asfixia. Pequenas partes.
Προειδοποίηση! Κίνδυνος πνιγμού. Μικρά μέρη.
警告! 小部品があります。誤飲・窒息の危険があります。
警告! 小心窒息。当心小物件。
경고! 질식 위험. 작은 부품 포함.
Внимание! Риск удушения. Мелкие детали.
Ostrzeżenie! Niebezpieczeństwo udławienia się. Małe części.
Upozornění! Nebezpečí zalknutí. Malé části.
Upozornenie! Nebezpečenstvo dusenia. Malé časti.
Figyelmeztetés! Fulladásveszély. Kis alkatrészek.
Πολερδζηννη! Ριζικ ζαδυχι. Δριβνη δεταλι.
Urozorenje! Opasnost od gušenja. Mali dijelovi.
Упозорење! Опасност од гушења. Мали делови.
Предупредување! Опасност од задушвање. Мали делови.
Oporozorilo! Nevarnost zadušitve zaradi tujka. Majhni deli.
Avertisment! Pericol de sufocare internă. Părți mici.
Внимание! Опасност от задавяне. Малки части.
Brīdinājums! Aizrīšanās risks. Sīkas detaļas.
Hoiatus! Kāgistamisoht. Väikesed osad.
İspėjimas! Pavojus užspringti. Smulkios detalės.
Uyarı! Boğulma Tehlikesi (Havasızlıktan). Küçük Parçalar.
تحذیر! خطر الاختناق. أجزاء صغيرة.
Peringatan! Bahaya tersedak. Bagian kecil.
Amaran! Bahaya tercekik. Bahagian kecil.



WARNING: CHOKING HAZARD.
Small parts. Not for children under 3 years.



AVERTISSEMENT : RISQUE D'ÉTOUFFEMENT.
Contient des petites pièces. Ne convient pas aux enfants de moins de 3 ans.



ADVERTENCIA: PELIGRO DE ASFIXIA.
No recomendado para niños menores de 3 años. Contiene piezas pequeñas.

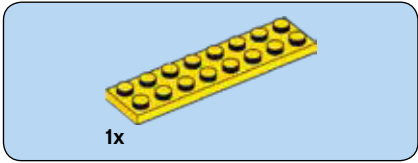
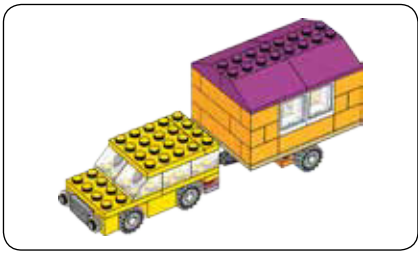

1

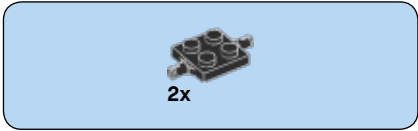
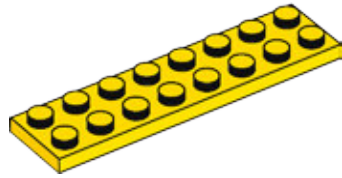

2

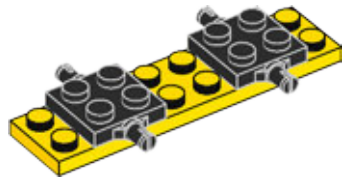

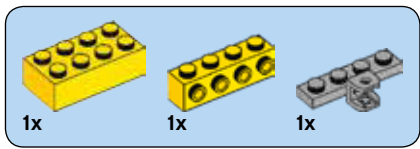

3

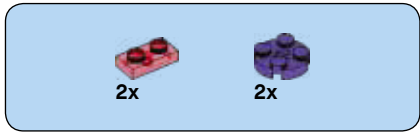
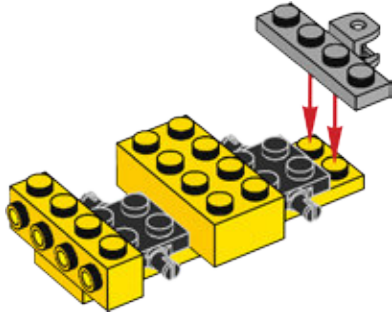

4

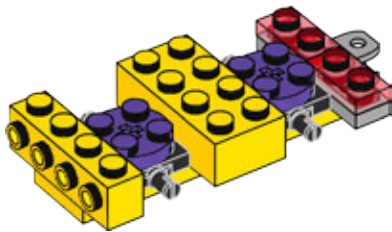

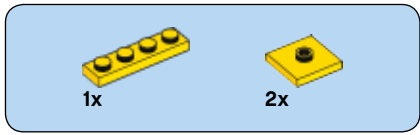

5

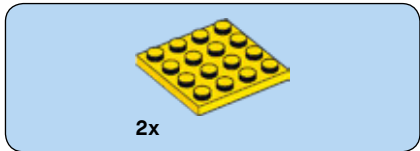
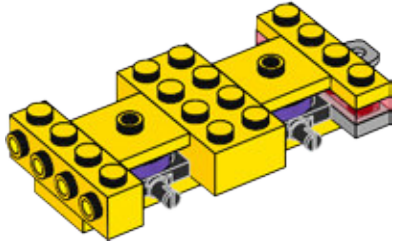

6

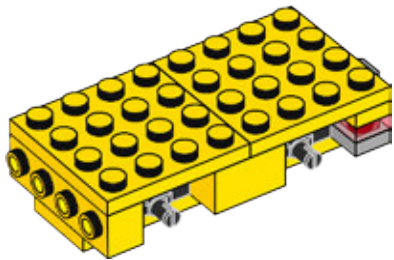

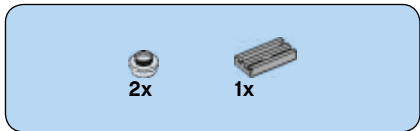

7

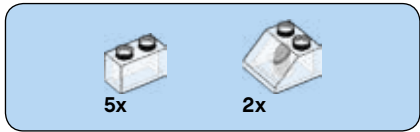
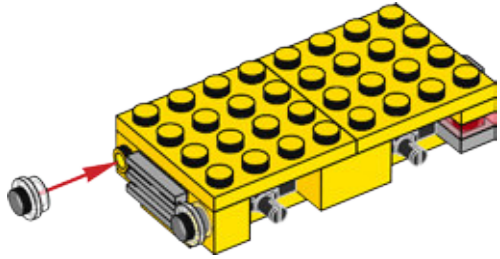

8

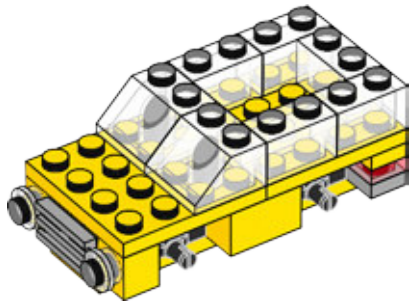

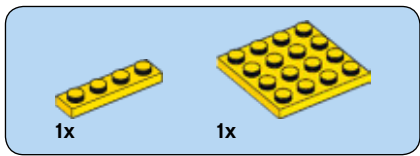

9

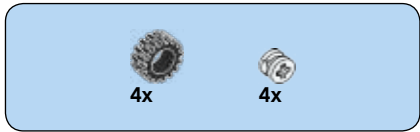
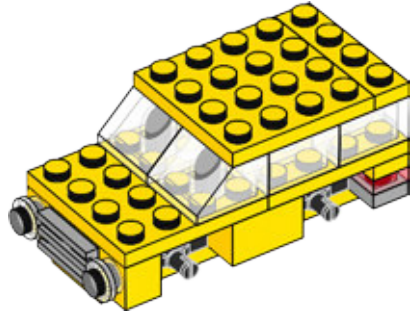

10

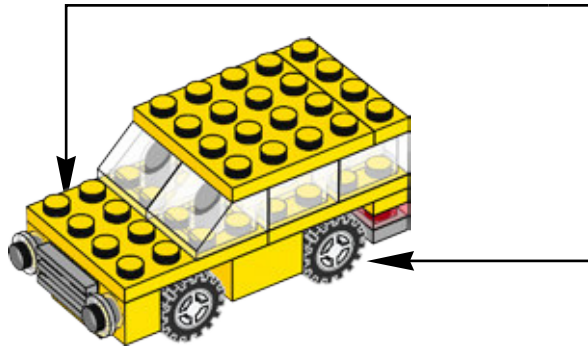
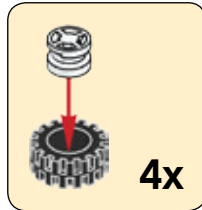

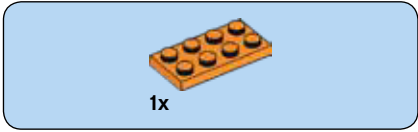

11

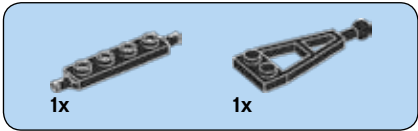

12

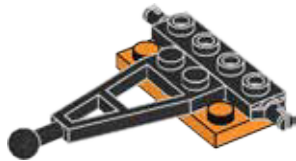



1x

13

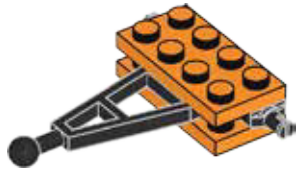

2x

14

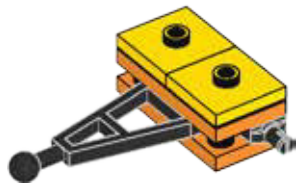

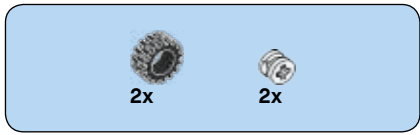

15

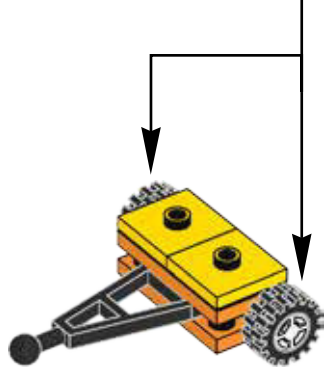
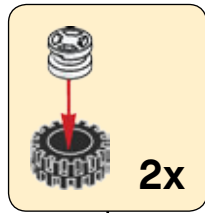

16

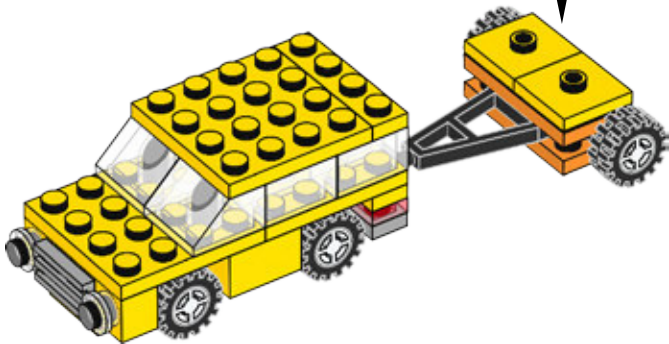

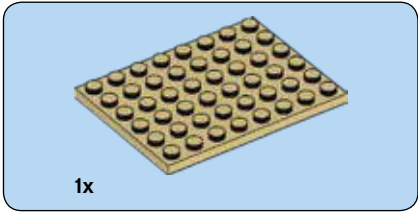

17

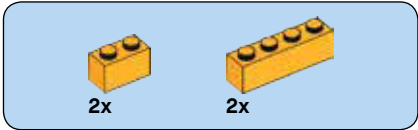
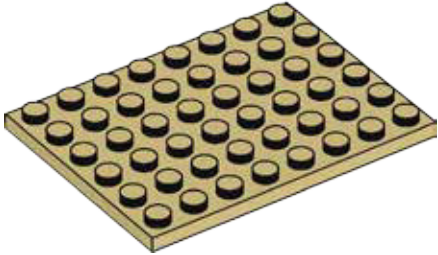

18

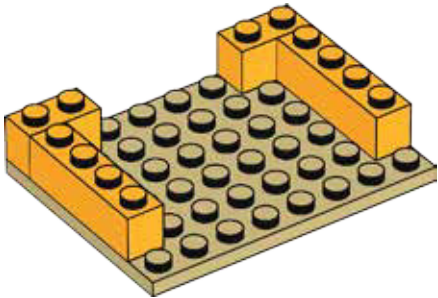

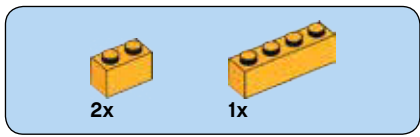

19

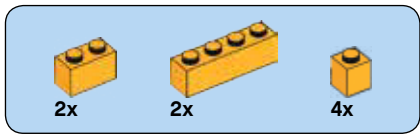
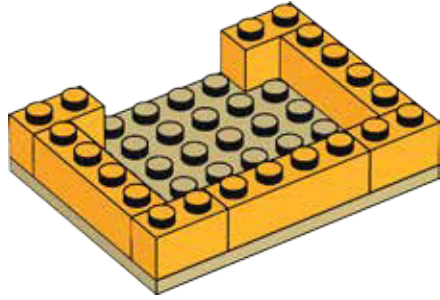

20

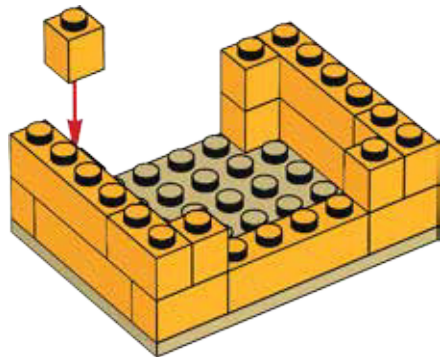

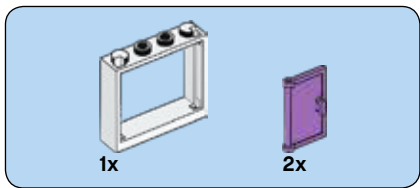

21

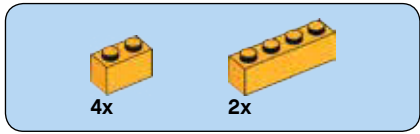
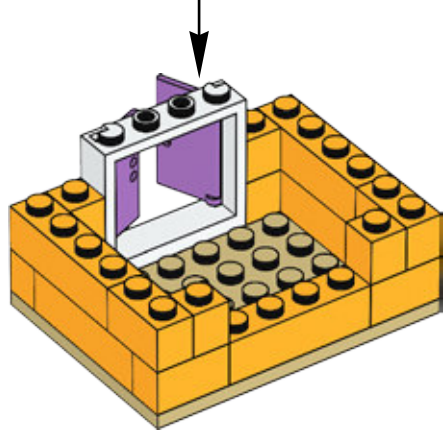
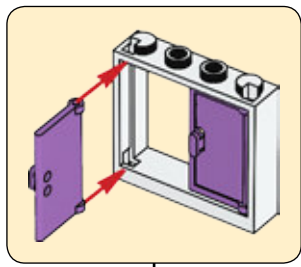

22

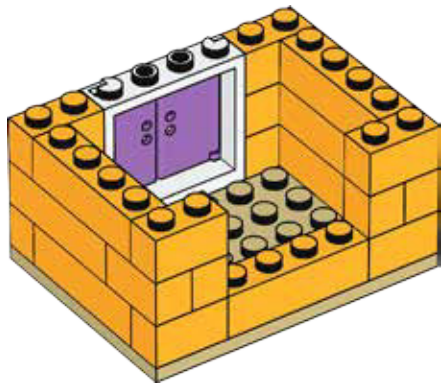

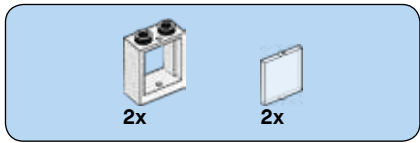

23

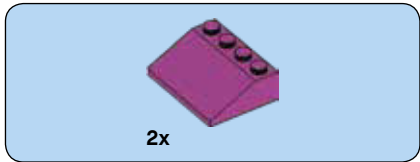
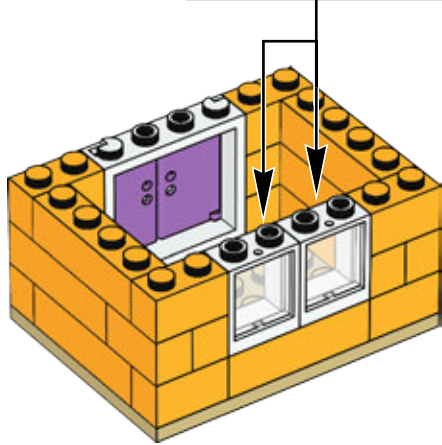
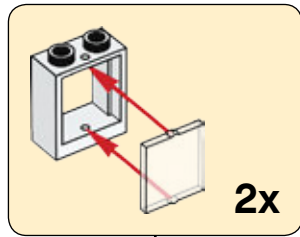

24

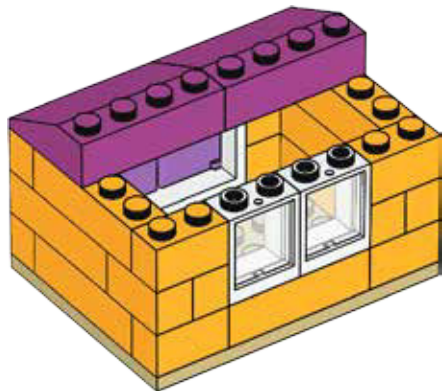

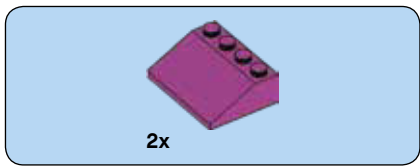

25

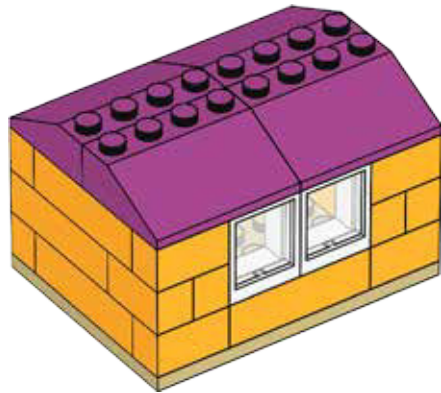

26

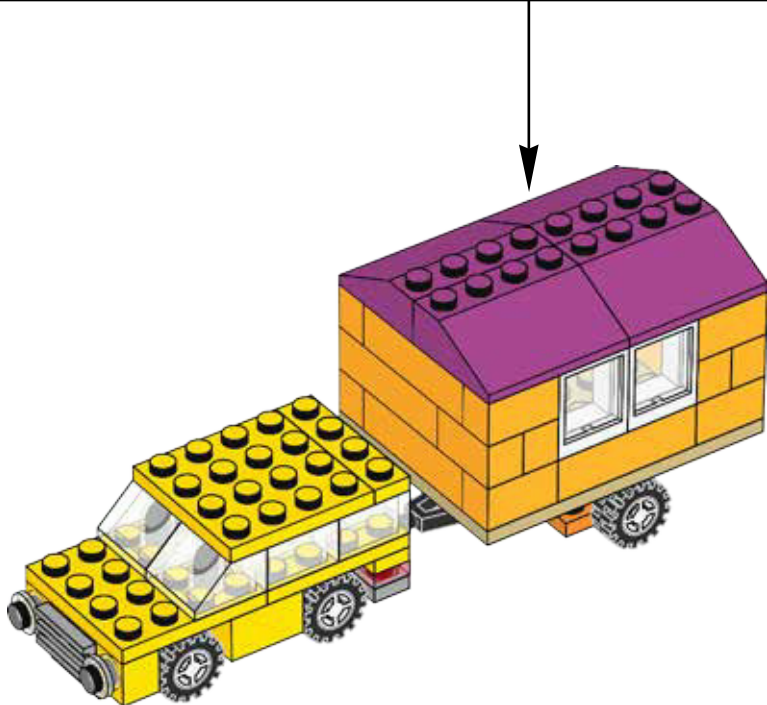



LEGO and the LEGO logo are trademarks of the/sont des marques de commerce du/son marcas registradas de LEGO Group. ©2018 The LEGO Group.



CLASSIC



10715



Warning! Choking hazard. Small parts.
Achtung! Erstickungsgefahr. Kleine Teile.
Attention ! Danger d'étouffement. Petits éléments.
Avvertenza! Rischio di soffocamento. Piccole parti.
Waarschuwing! Verstikkingsgevaar. Kleine onderdelen.
¡Advertencia! Peligro de atragantamiento. Partes pequeñas.
Advarsel! Kvælningsfare. Små dele.
Viðvörðun! Kófnunarhætta. Litlir hlutir.
Varoitus! Tukehtumisvaara. Pieniä osia.
Varning! Kvävningrisk. Små delar.
Advarsel! Kvelningsfare. Små deler.
Atenção! Risco de asfixia. Pequenas partes.
Προειδοποίηση! Κίνδυνος πνιγμού. Μικρά μέρη.
警告! 小部品があります。誤飲・窒息の危険があります。
警告! 小心窒息。当心小物件。
경고! 질식 위험. 작은 부품 포함.
Внимание! Риск удушения. Мелкие детали.
Ostrzeżenie! Niebezpieczeństwo udławienia się. Małe części.
Upozornění! Nebezpečí zalknutí. Malé části.
Upozornenie! Nebezpečenstvo dusenia. Malé časti.
Figyelmeztetés! Fulladásveszély. Kis alkatrészek.
Ποпередження! Ризик задухи. Дрібні деталі.
Urozorenje! Opasnost od gušenja. Mali dijelovi.
Упозорење! Опасност од гушења. Мали делови.
Предупредување! Опасност од задушвање. Мали делови.
Orozorilo! Nevarnost zadušitve zaradi tujka. Majhni deli.
Avertisment! Pericol de sufocare internă. Părți mici.
Внимание! Опасност от задавяне. Малки части.
Brīdinājums! Aizrīšanās risks. Sīkas detaļas.
Hoiatus! Kähgistamisohu. Väikesed osad.
İspējimas! Pavojus užspringti. Smulkios detalės.
Uyarı! Boğulma Tehlikesi (Havasızlıktan). Küçük Parçalar.
تحذیر! خطر الاختناق. أجزاء صغيرة.
Peringatan! Bahaya tersedak. Bagian kecil.
Amaran! Bahaya tercekik. Bahagian kecil.



WARNING: CHOKING HAZARD.
Small parts. Not for children under 3 years.



AVERTISSEMENT : RISQUE D'ÉTOUFFEMENT.
Contient des petites pièces. Ne convient pas aux enfants de moins de 3 ans.



ADVERTENCIA: PELIGRO DE ASFIXIA.
No recomendado para niños menores de 3 años. Contiene piezas pequeñas.

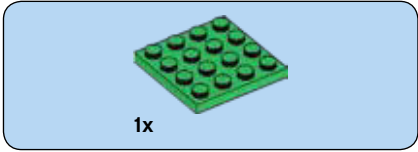
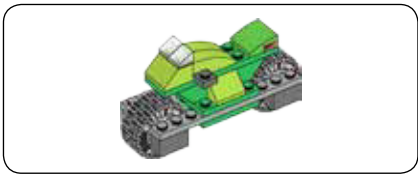

1

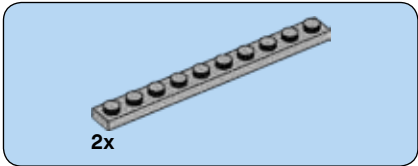
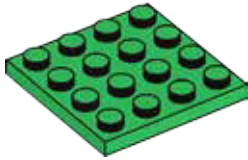

2

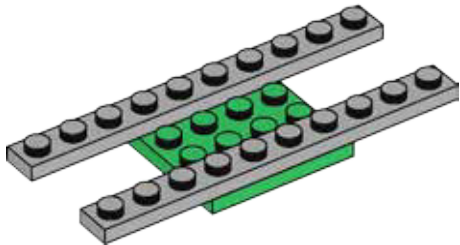

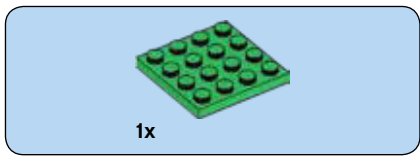

3

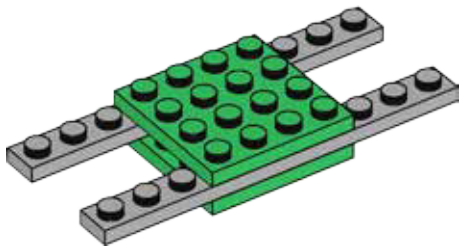

4

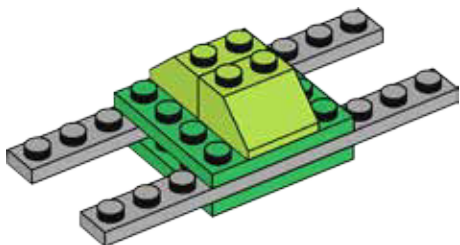

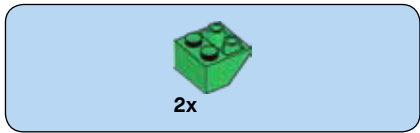

5

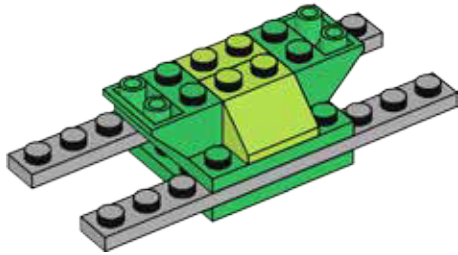

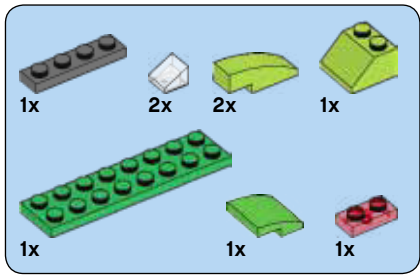

6

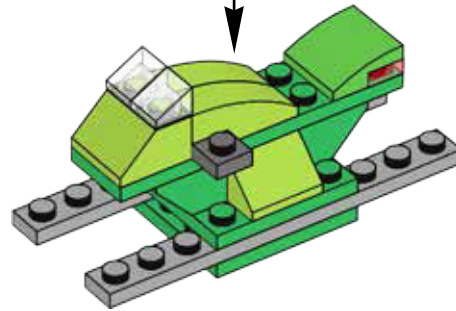
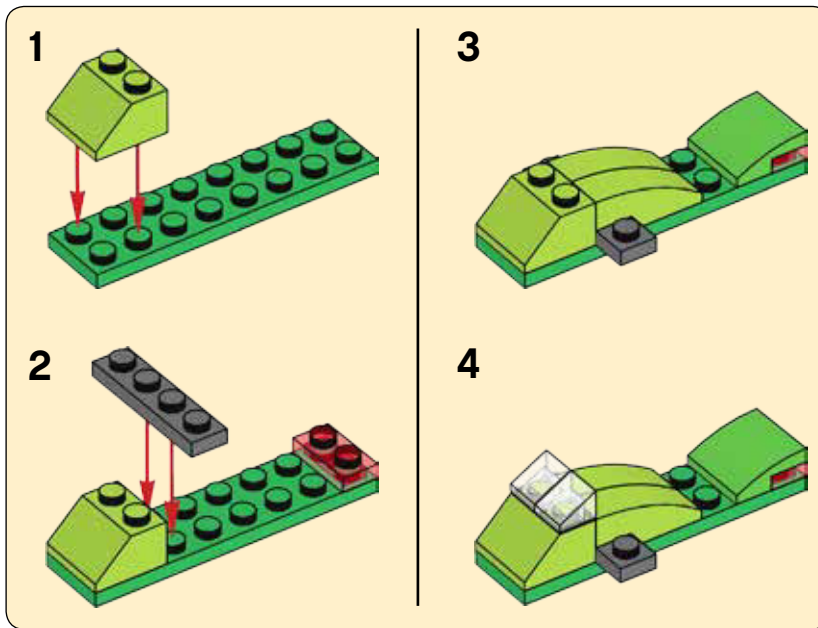

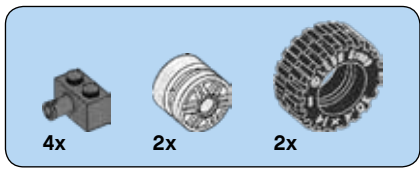

7

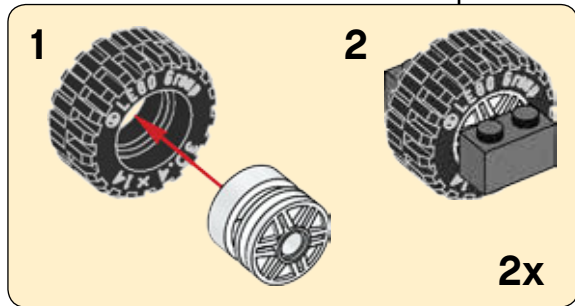
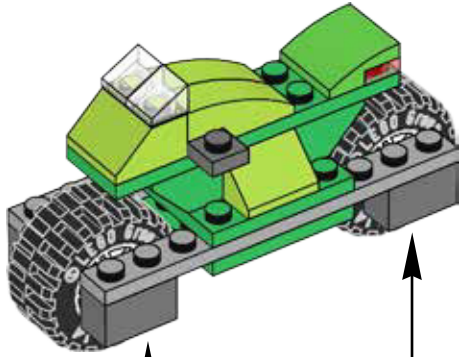



LEGO and the LEGO logo are trademarks of the/sont des marques de commerce du/son marcas registradas de LEGO Group. ©2018 The LEGO Group.



CLASSIC

10715



 [LEGO.com/classic](https://www.lego.com/classic)





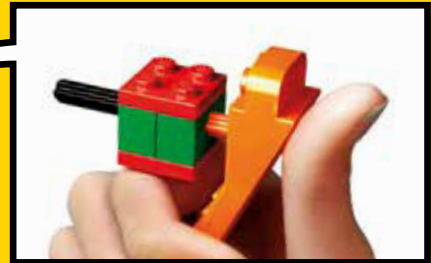

LEGO.com/brickseparator



Easy building
Einfach zu bauen
Construction facile
Costruzione facile
Construcción fácil
Construção fácil
Kezdő építőknek
简单拼砌



Medium building
Mittelschwer
Construction intermédiaire
Costruzione media
Construcción intermedia
Construção intermédia
Gyakorló építőknek
中级拼砌



Advanced building
Fortgeschritten
Construction avancée
Costruzione avanzata
Construcción avanzada
Construção avançada
Tapasztalt építőknek
高级拼砌

Page
Seite
Page
Pagina
Página
Página
oldalszám
页码



Page
6



Page
14

Page
24

Page
32





LEGO.com/classic



1x



1x

1

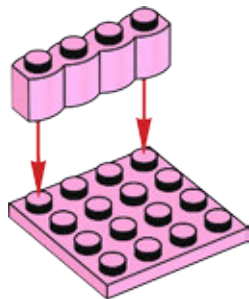

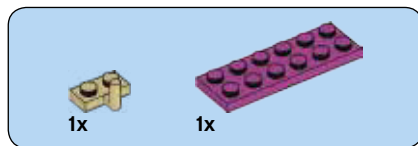

2

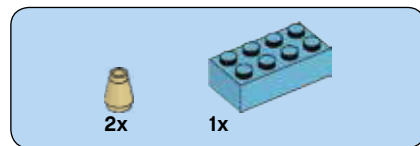
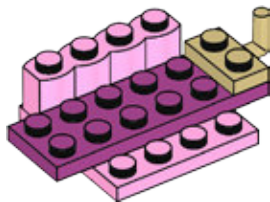

3

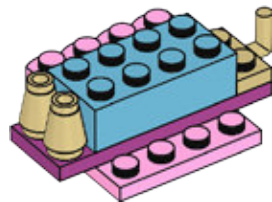



1x

4

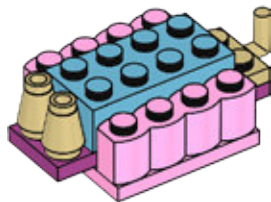

8



5

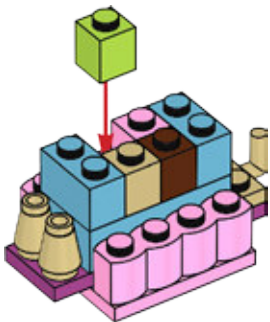

6

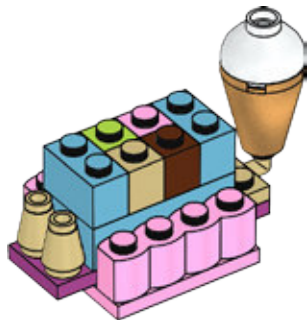
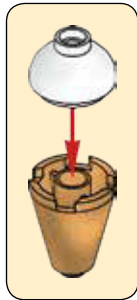



2x



2x

7





2x

8



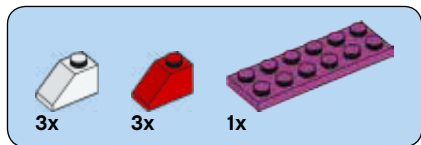

9

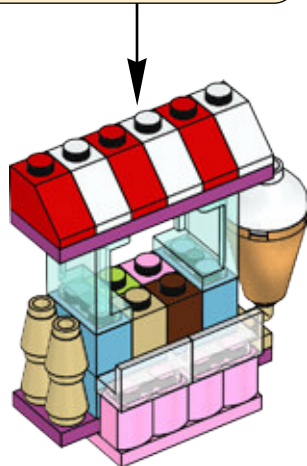
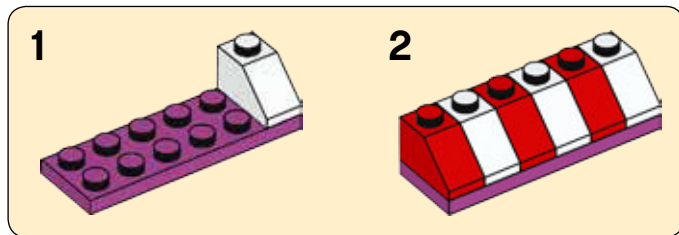



2x



2x

10

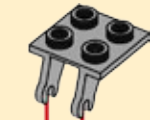

2x



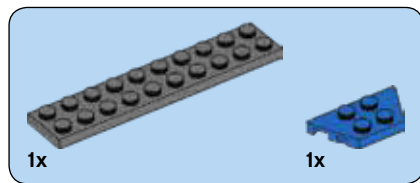

1

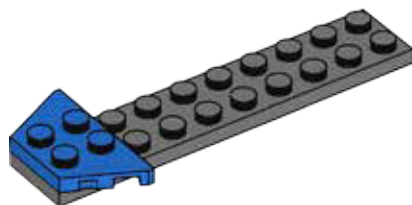

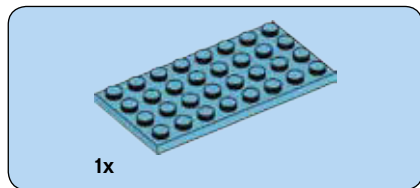

2

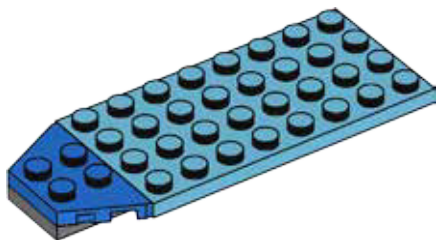

3

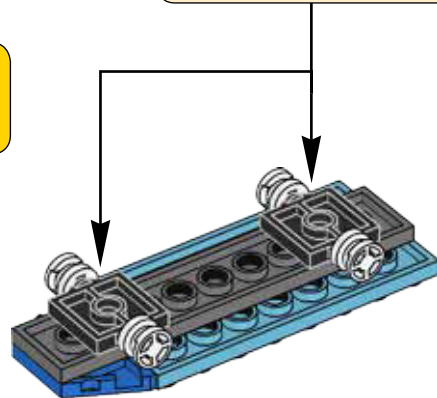
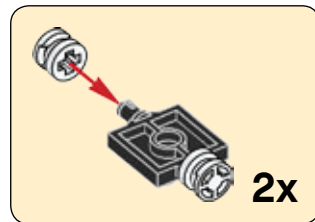



4

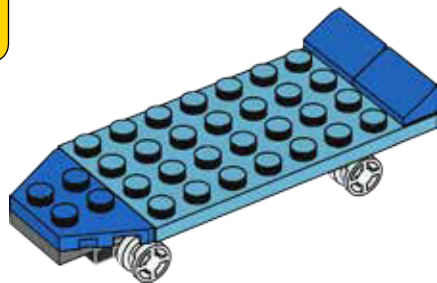

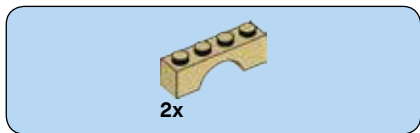

5

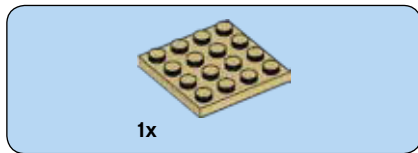
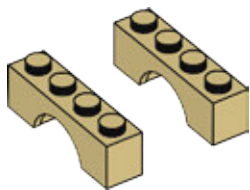

6

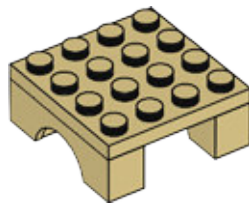



7

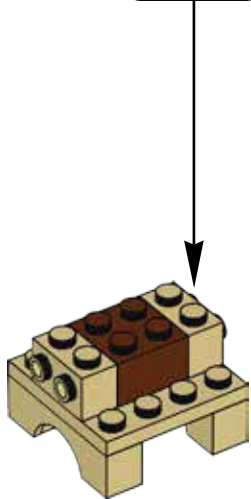
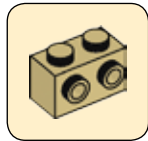

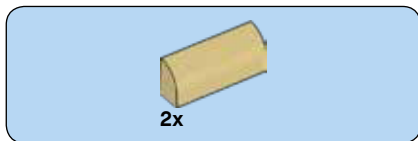

8

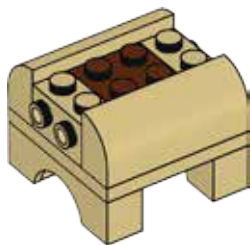

9

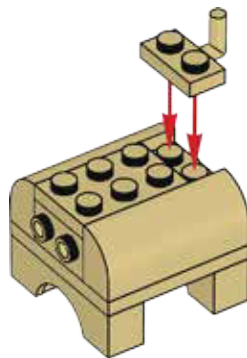



1x

10



20



1x



2x

11

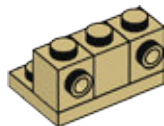



12

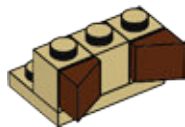

13

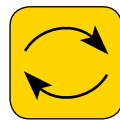



2x

14



1x



1x

15



16

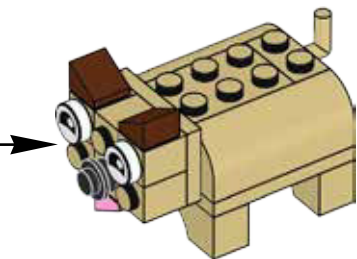

17

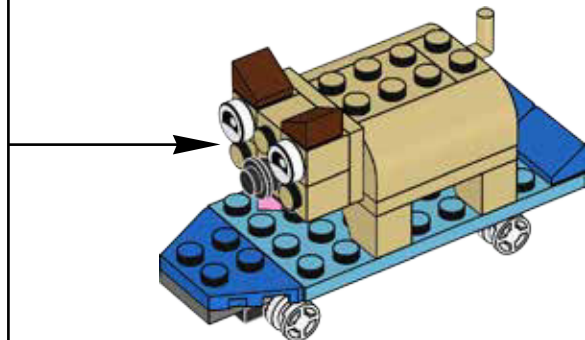

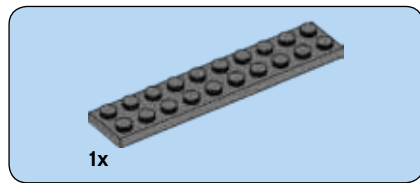

1

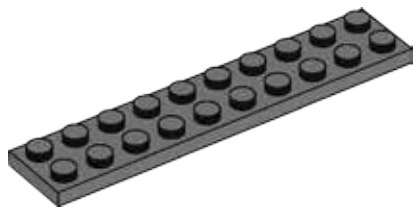



2

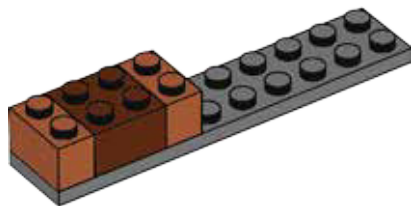

3

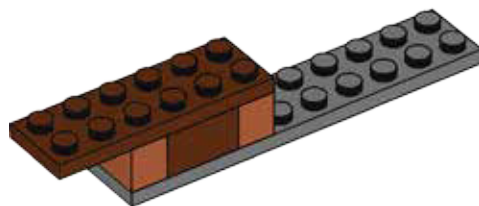

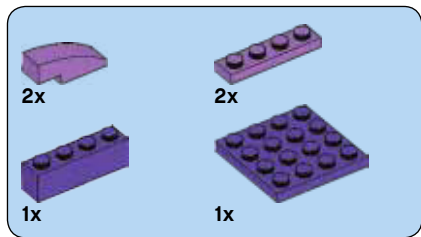

4

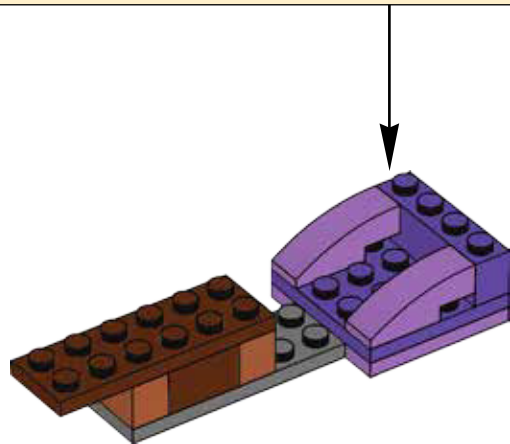
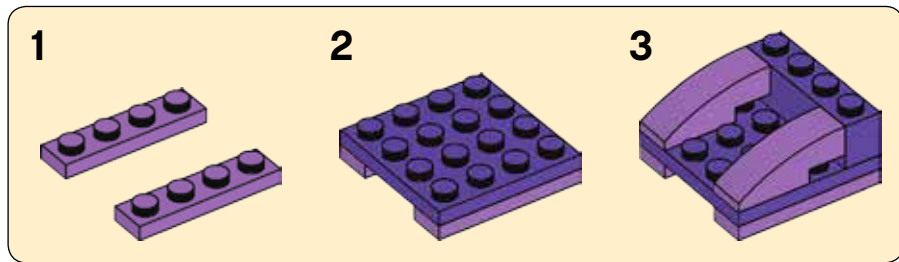



5

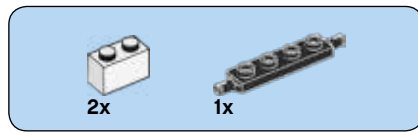
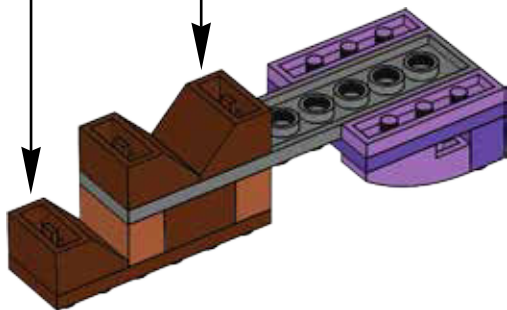
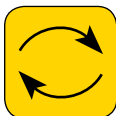
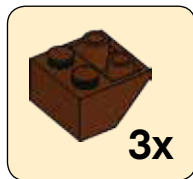

6

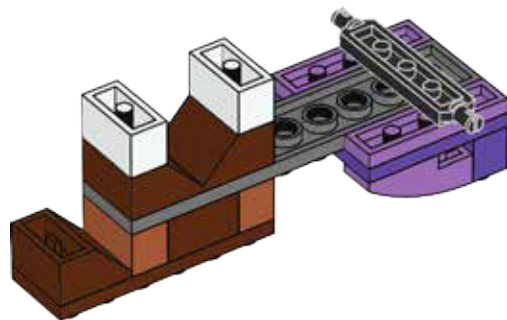



2x

7

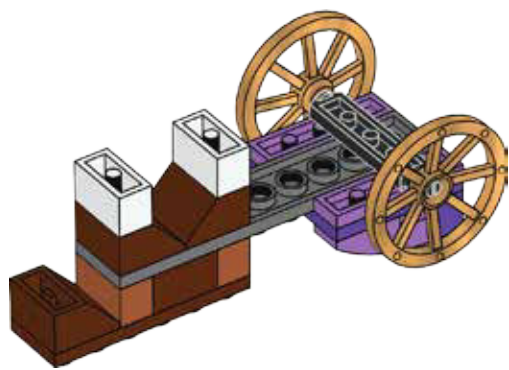



2x



2x

8

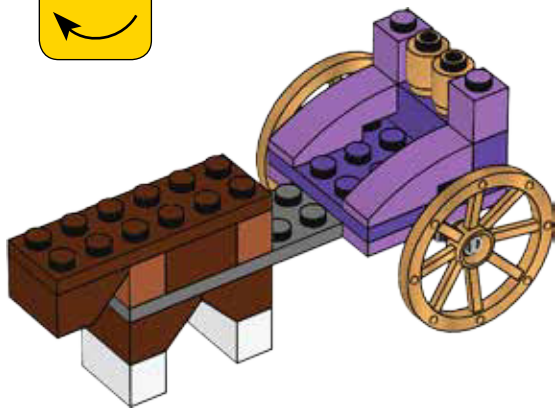

1x

9

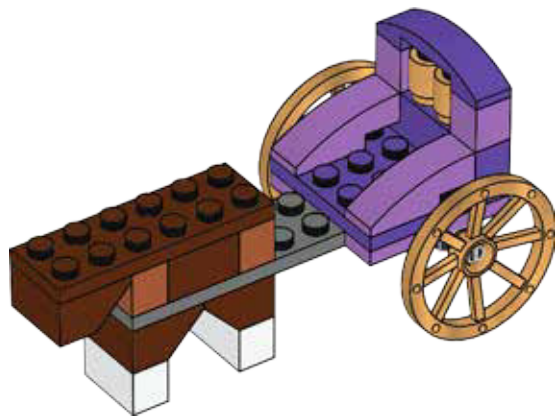



10

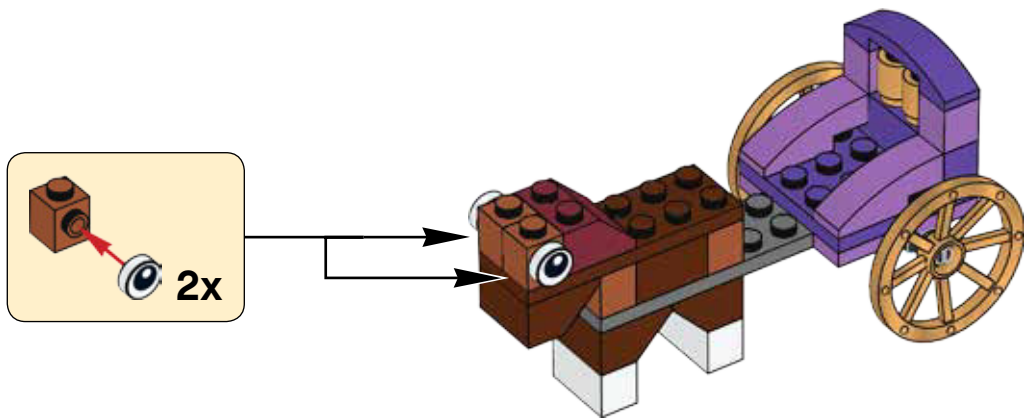



1x



2x

11

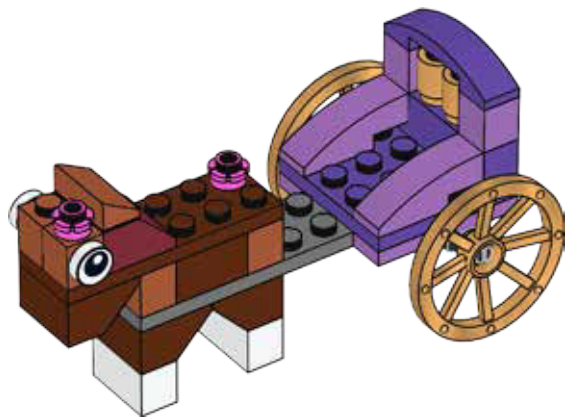

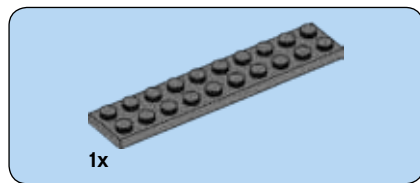

1

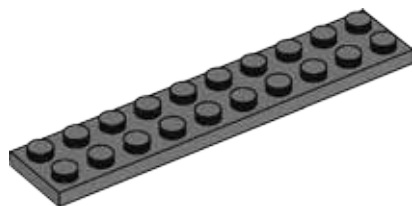

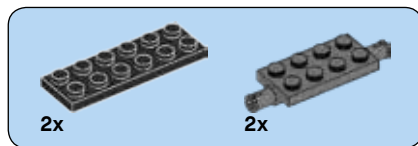

2

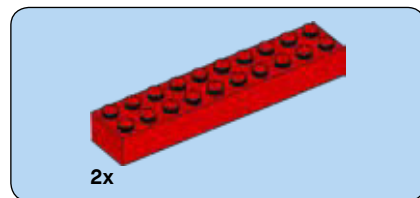
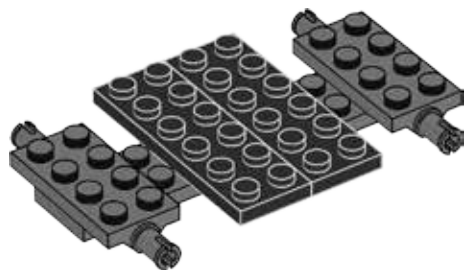

3

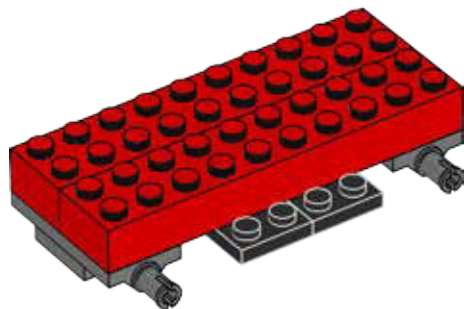



2x

4

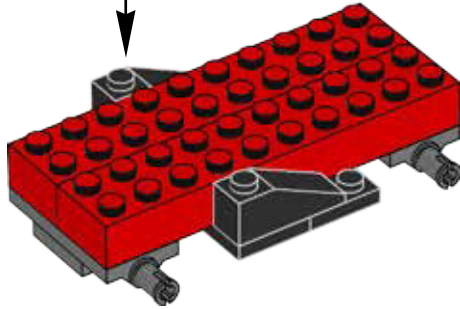
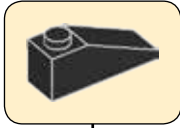

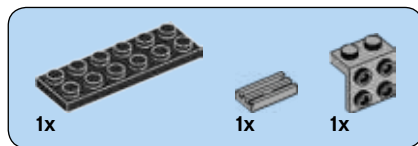

5

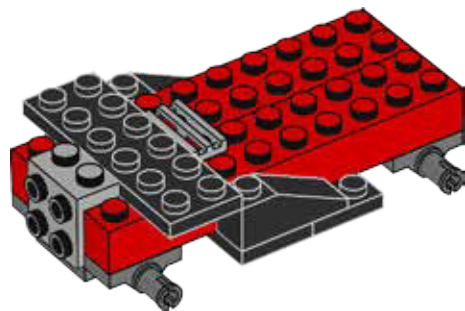

6

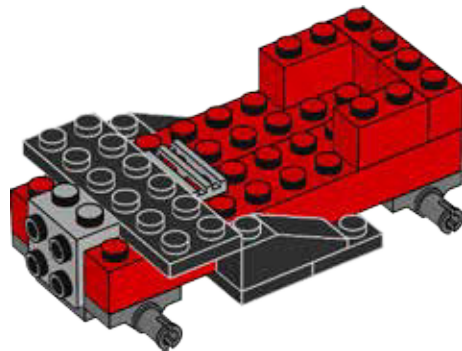

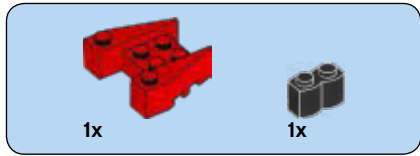

7

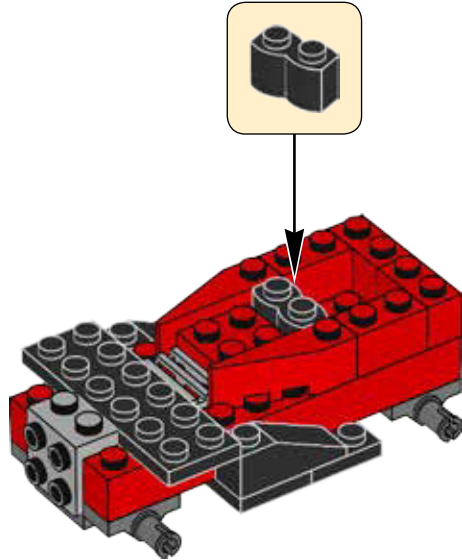



8

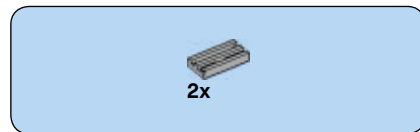
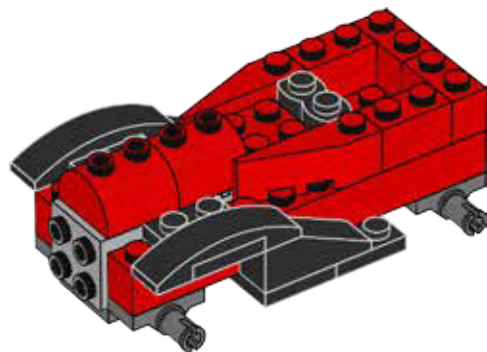

9

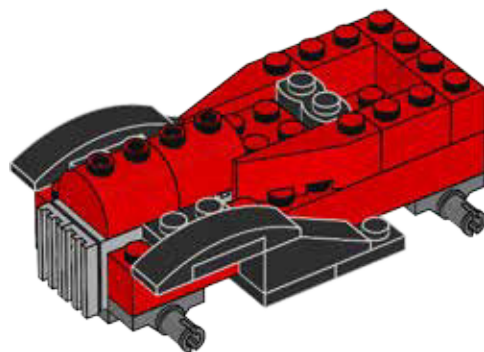



2x



2x

10

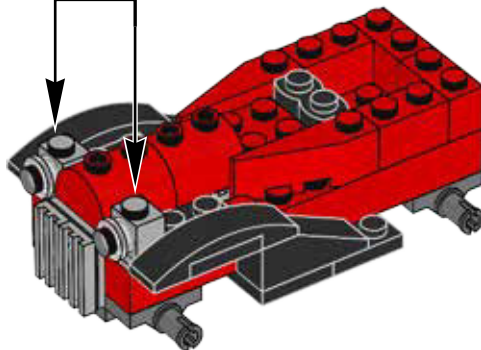
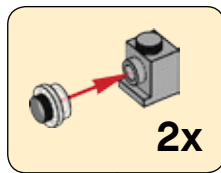



3x



2x

11

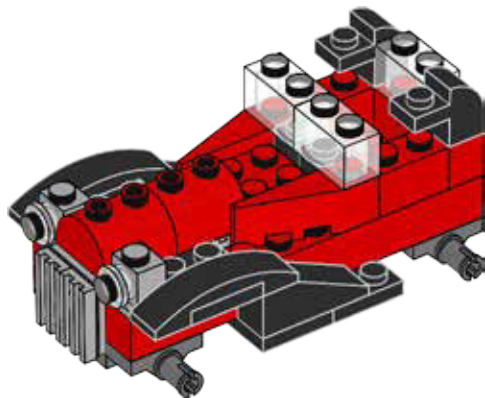

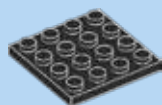

1x

12

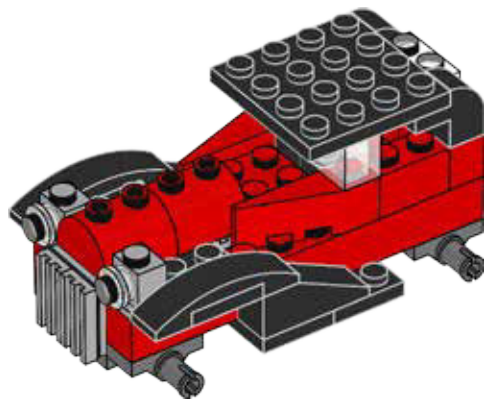

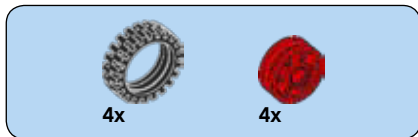

13

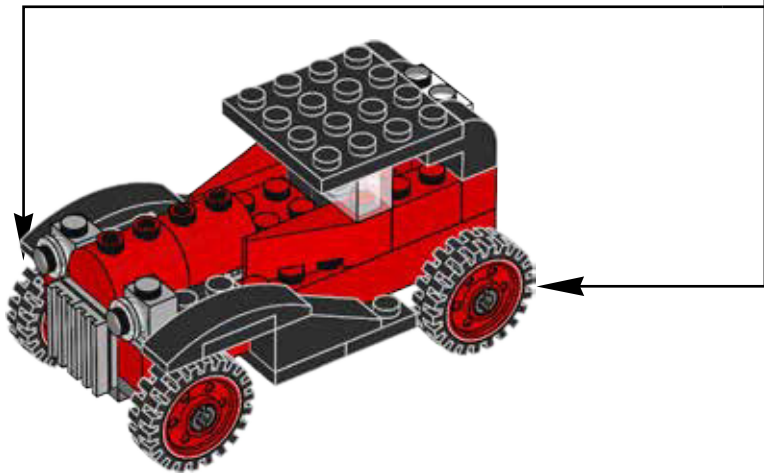
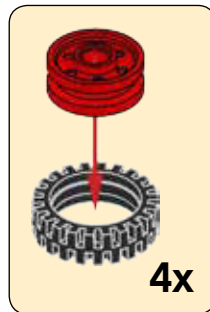

What fun things can you build with wheels?

Welche lustigen Sachen kannst du mit Rädern bauen?

Quelles constructions sympas peux-tu réaliser avec des roues?

Quale divertente modello sai costruire con le ruote?

¿Qué cosas divertidas puedes construir con ruedas?

Que coisas divertidas podes construir com rodas?

Milyen érdekes dolgokat tudnál megépíteni a kerekekkel?

您用轮子能拼搭出哪些有趣的东西呢？





10698



10696



10700



10714



10742



10743





CREATOR

3ⁱⁿ1

3 in 1
3 en 1
3 em 1
3 az egyben
3 合 1



31075

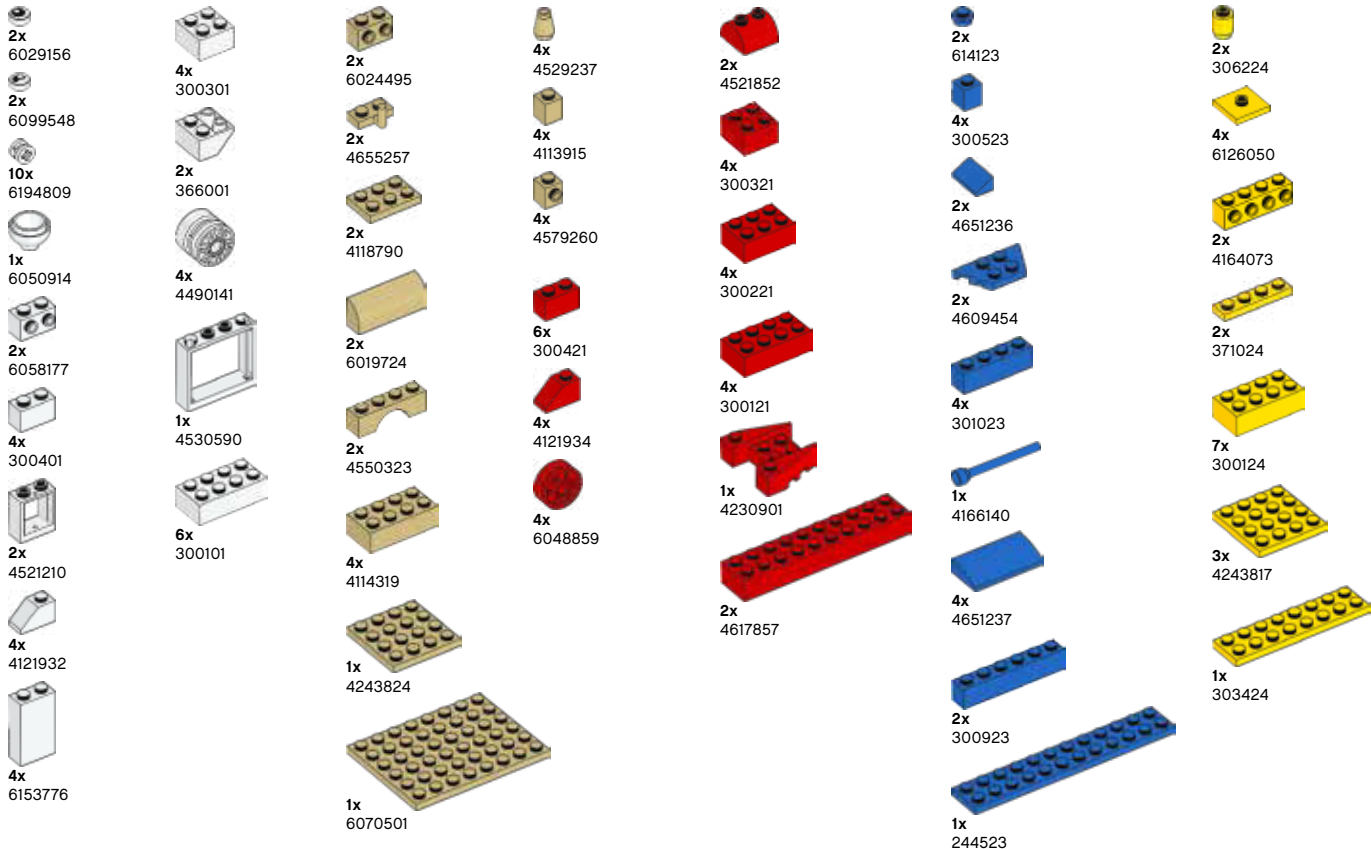

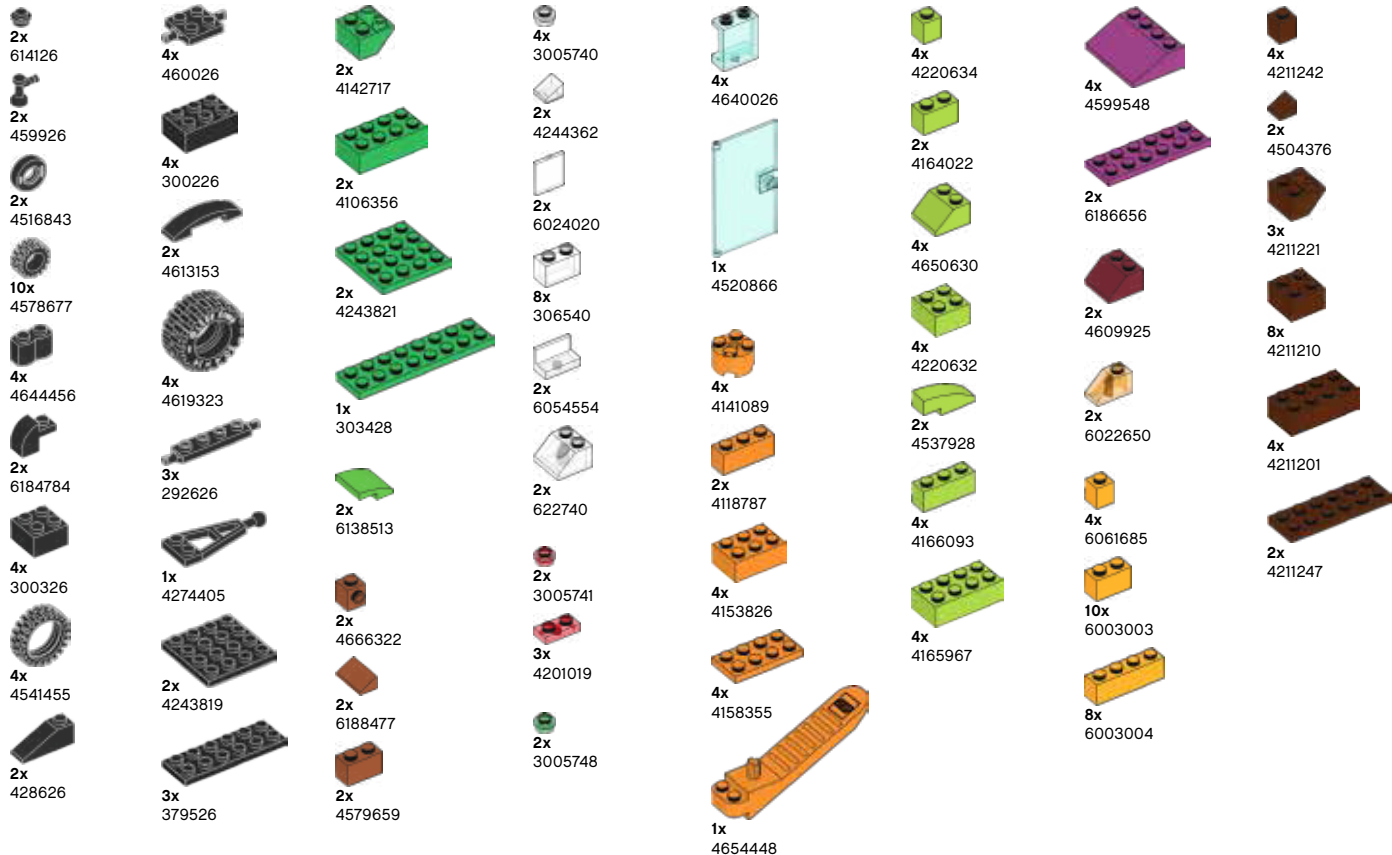



Customer Service

Kundenservice

Service Consommateurs

Servicio Al Consumidor

LEGO.com/service or dial



: 00800 5346 5555

: 1-800-422-5346

WIN

GO TO WWW.LEGO.COM/PRODUCTFEEDBACK AND
GIVE US YOUR SHORT **FEEDBACK** ABOUT THIS
LEGO® SET FOR A CHANCE TO WIN
A COOL LEGO PRIZE.

Terms & Conditions apply

LEGO.com/productfeedback



GEWINNE

Erzähle uns auf
www.LEGO.com/productfeedback

etwas über die Erfahrungen, die du mit
diesem LEGO® Set gemacht hast, und
sichere dir die Chance auf einen coolen
LEGO Preis!

Es gelten die Teilnahmebedingungen

GAGNE

Rends-toi sur
www.LEGO.com/productfeedback

et donne-nous quelques commentaires sur
ce produit LEGO® pour avoir une chance
de gagner un prix LEGO !

Voir Conditions Générales

GANAN

Visita
www.LEGO.com/productfeedback

y envíanos tu opinión acerca de este set
LEGO®. ¡Participarás en el sorteo de un
premio LEGO!

Términos y Condiciones aplicables

获取奖品

登录
www.LEGO.com/productfeedback

给出关于此乐高®套装的简短反馈，
就有机会获得炫酷乐高奖品

《条款及条件》适用

LEGO and the LEGO logo are trademarks of the LEGO Group. ©2018 The LEGO Group.

6225661