

**LEGO**

# NEXO KNIGHTS



70355





[LEGO.com/brickseparator](https://LEGO.com/brickseparator)

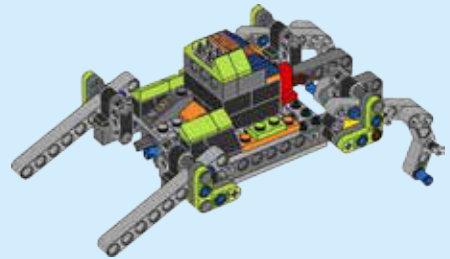
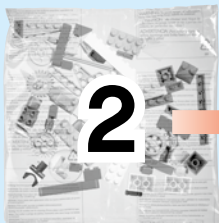



1

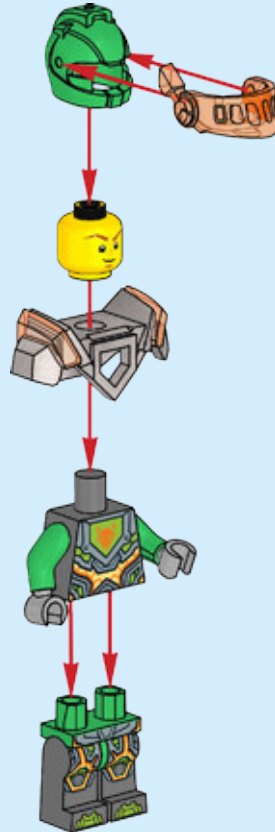



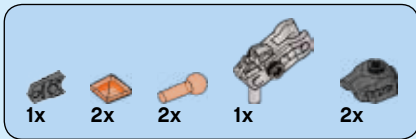

2

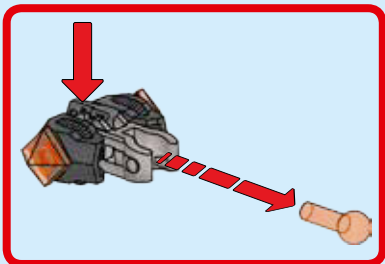
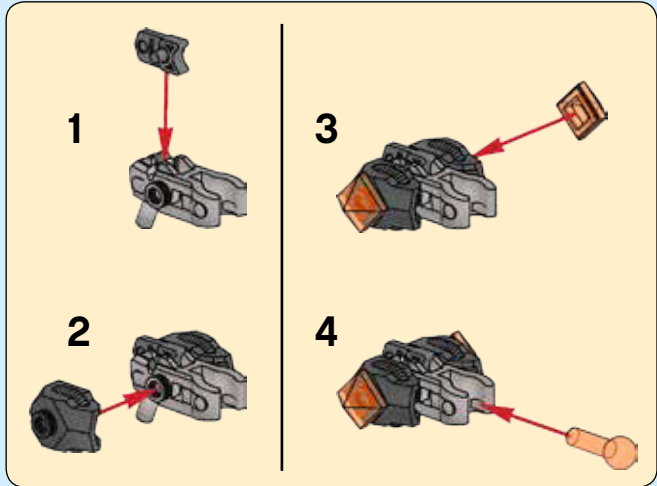

3



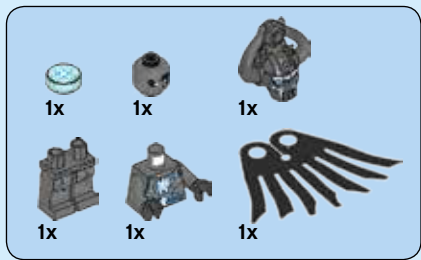

1



6

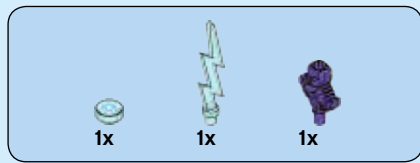

2

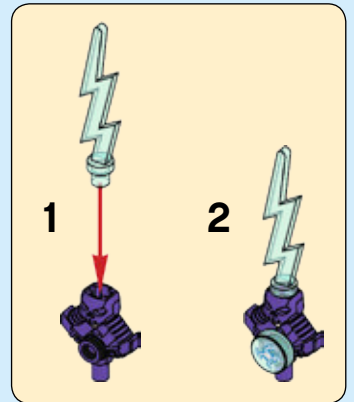

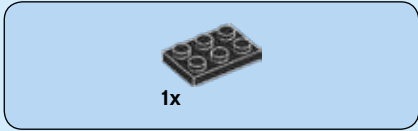
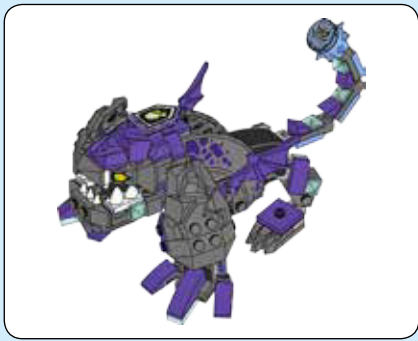

1x

**1**

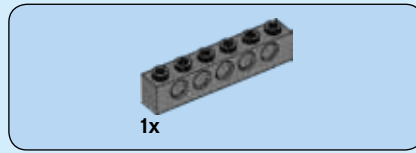
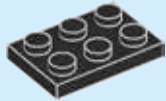

1x

**2**

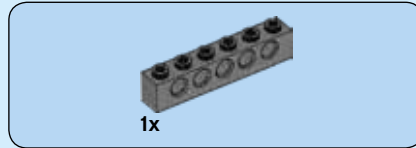
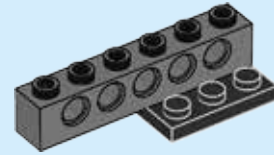

1x

**3**





4x

4

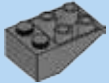
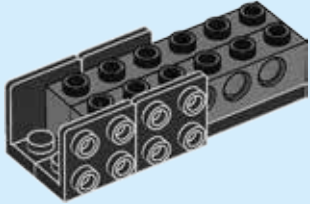

1x

5



2x

6

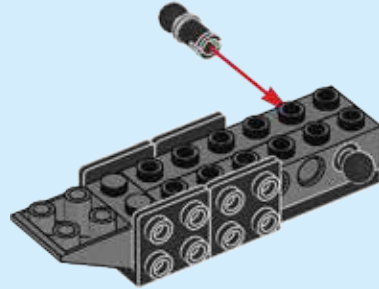

1x

7

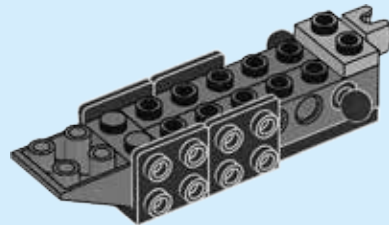



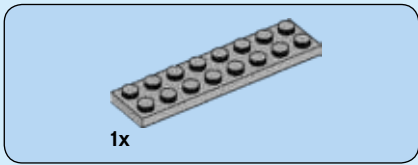

8

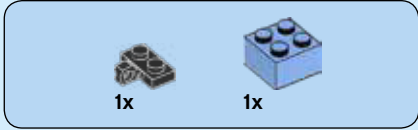
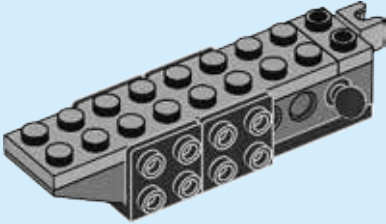

9

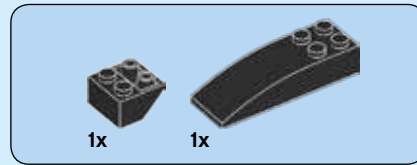
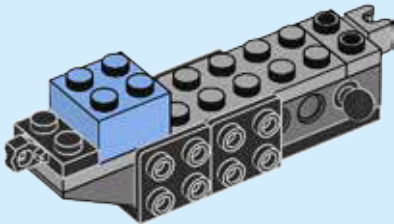

10

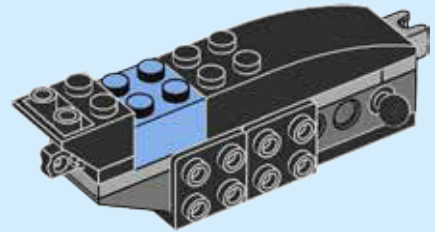

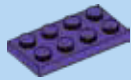

1x

11

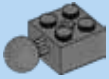
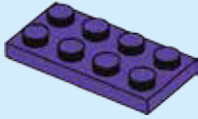

2x

12

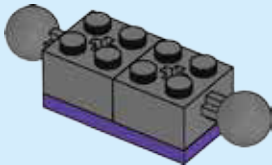

2x

13

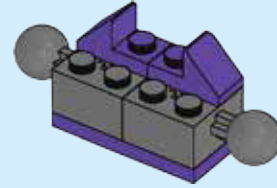

2x

14

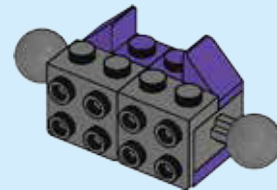

15

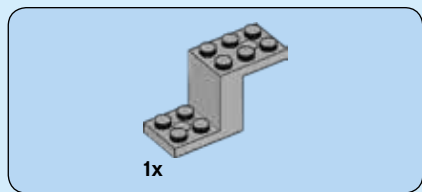
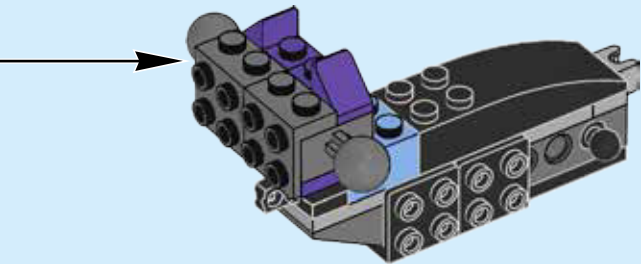

16

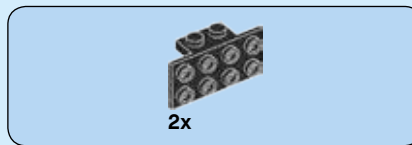
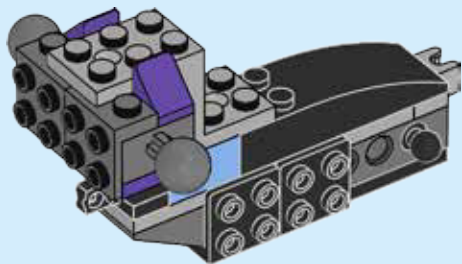

17

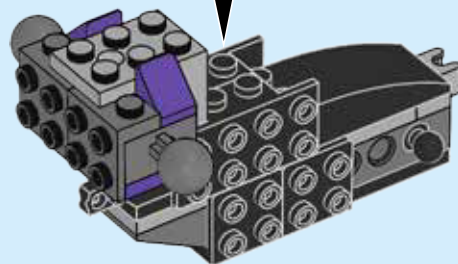
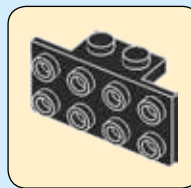

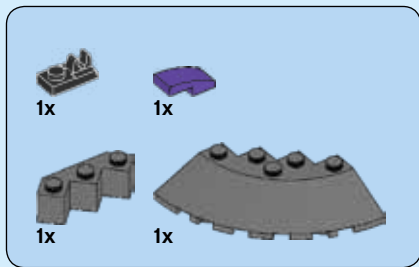

18

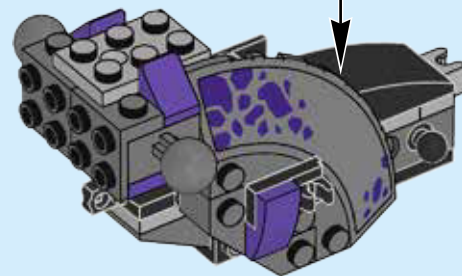
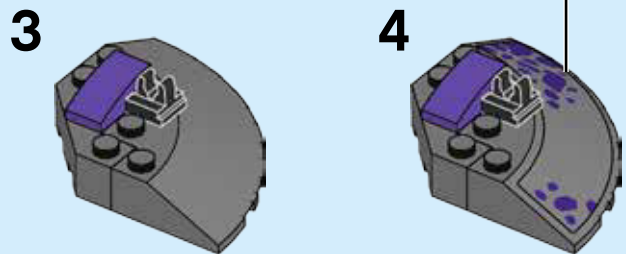
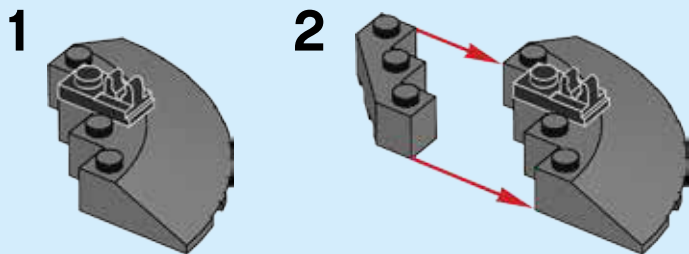



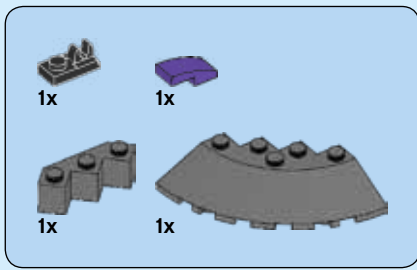

# 19

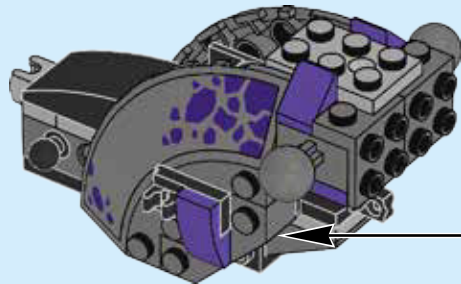
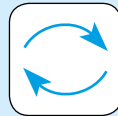
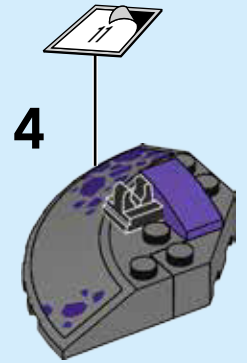
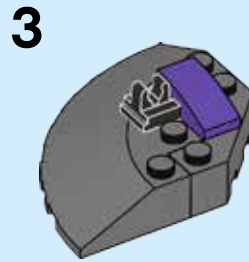
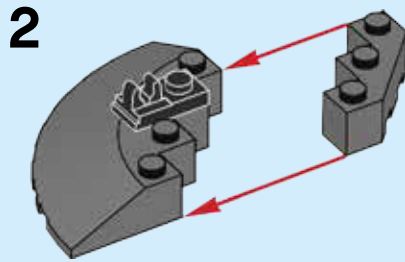
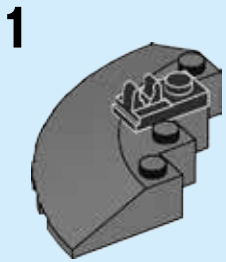

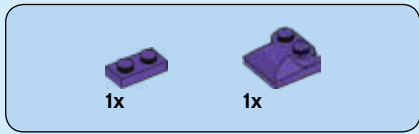

20

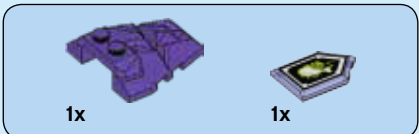
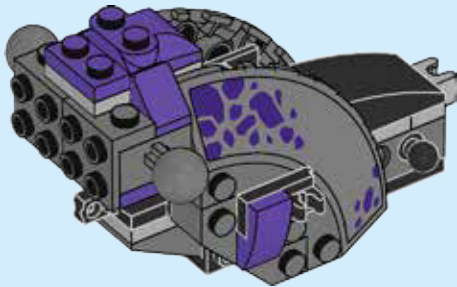
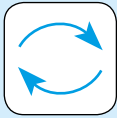

21

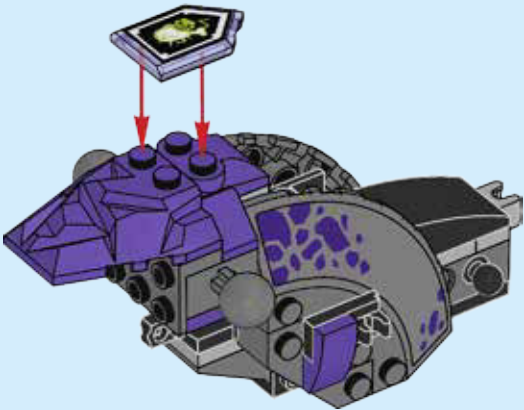

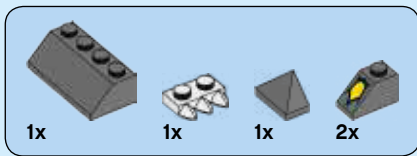

22

1



2

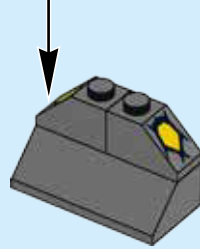

3

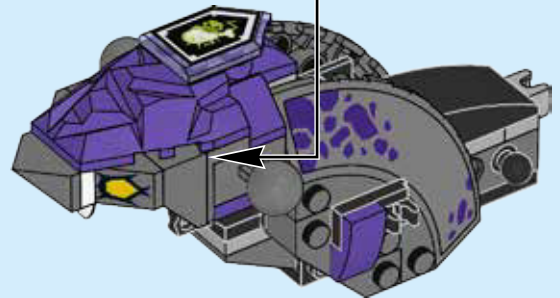
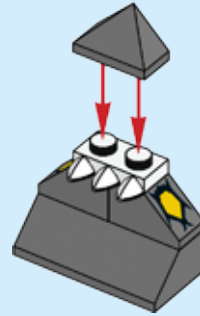



1x

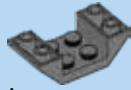

1x

23

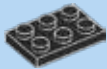
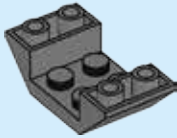

1x

24

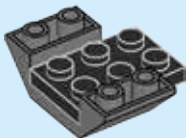

1x



1x



1x

25

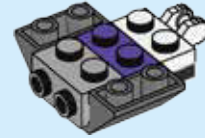

2x

26

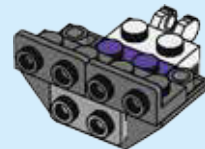



2x



27

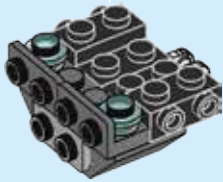
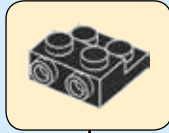

1x



28

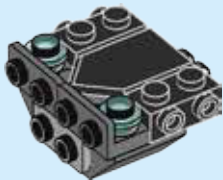

2x



29

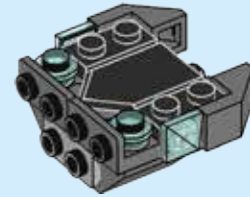

1x



30

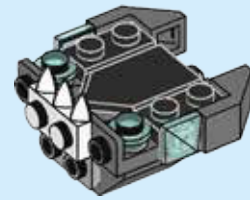

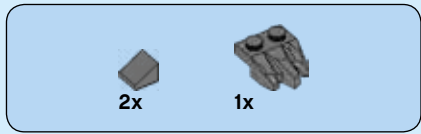

31

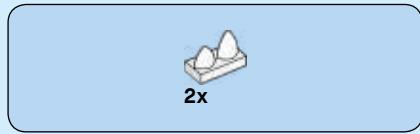
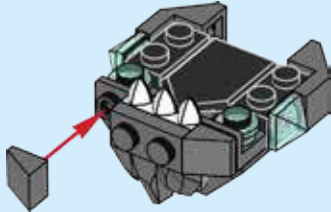

32

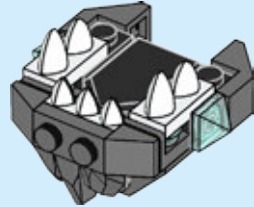

33

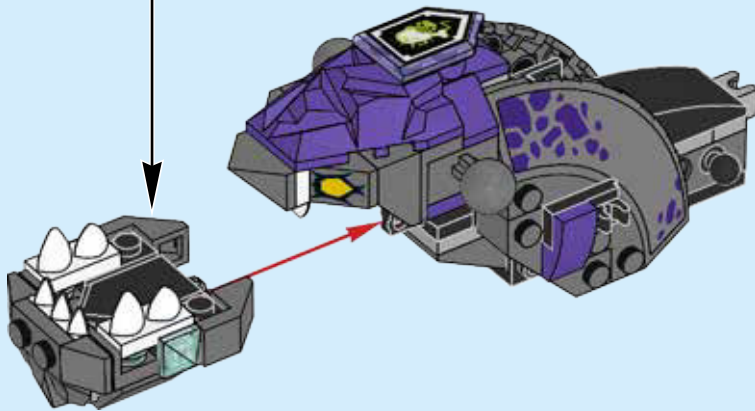

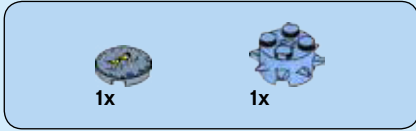
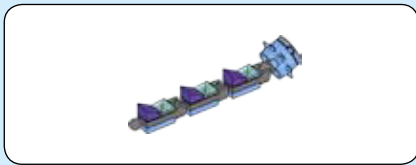

34

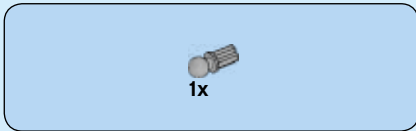
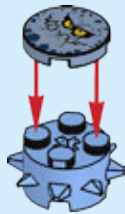

35

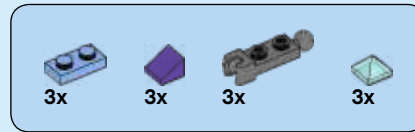

36

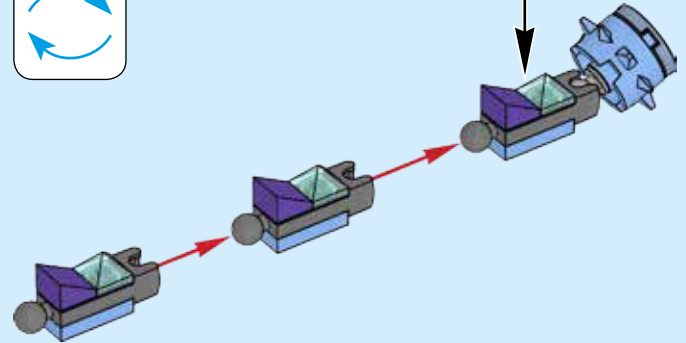
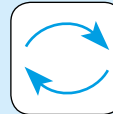
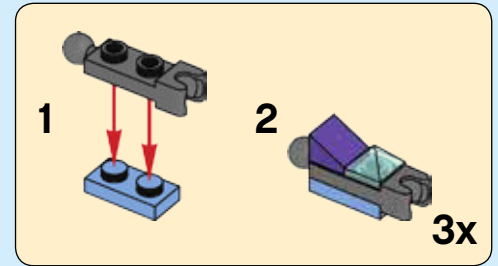

37

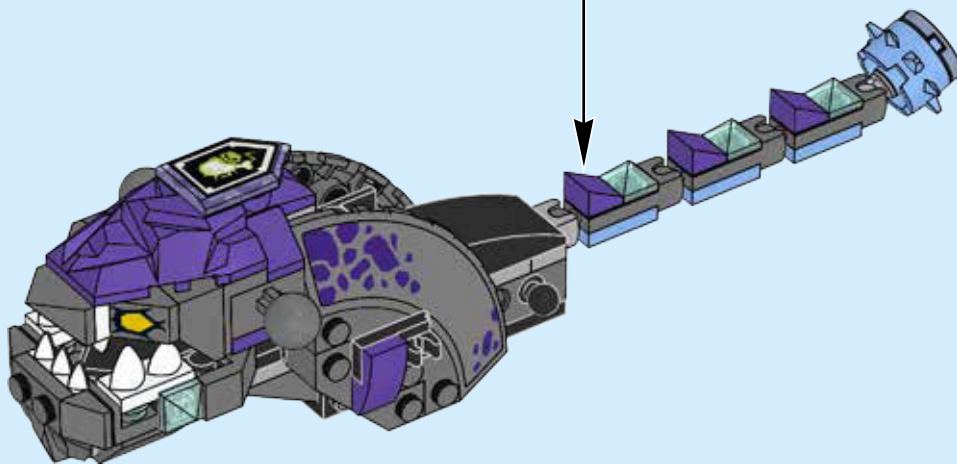

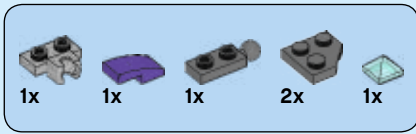

# 38

1

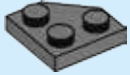

2

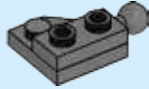

3

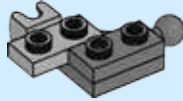

4

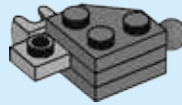

5

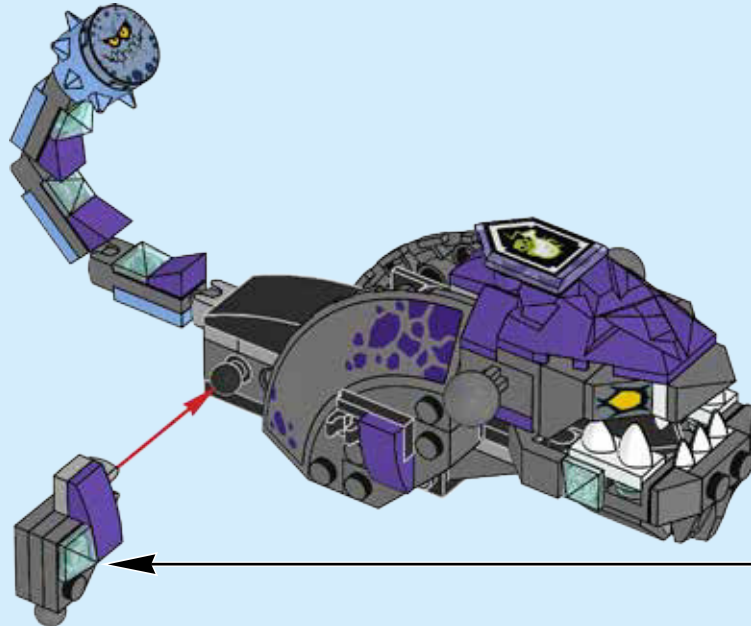
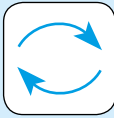
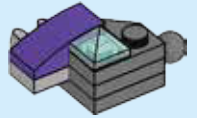

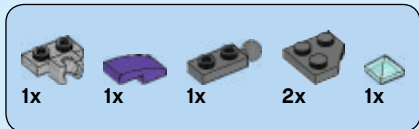

# 39

1

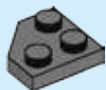

2

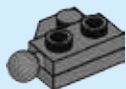

3

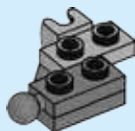

4



5

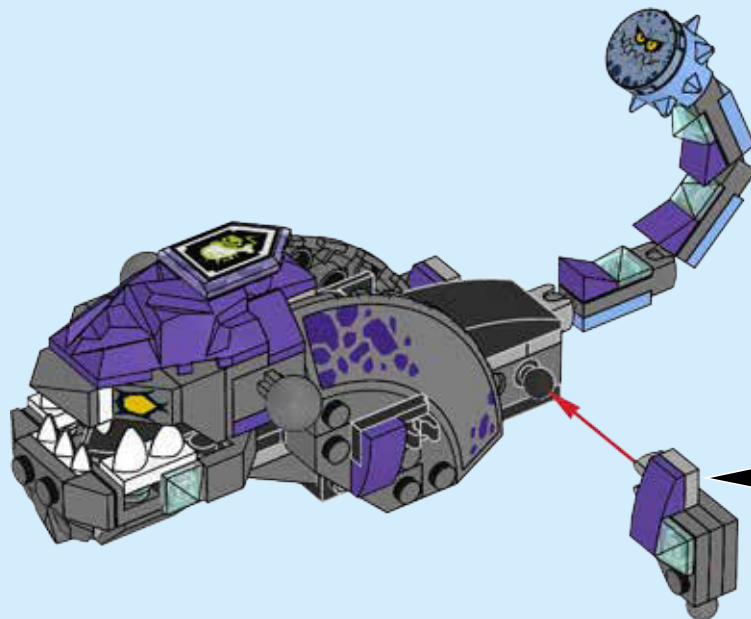
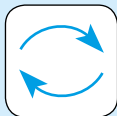
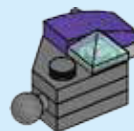



40

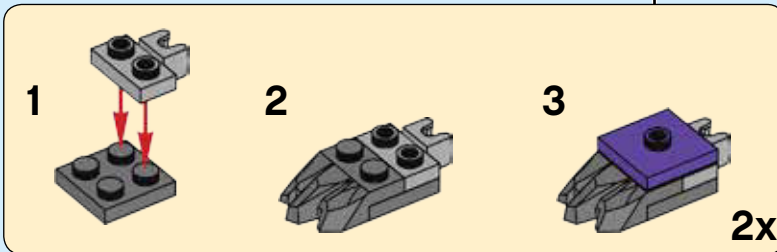
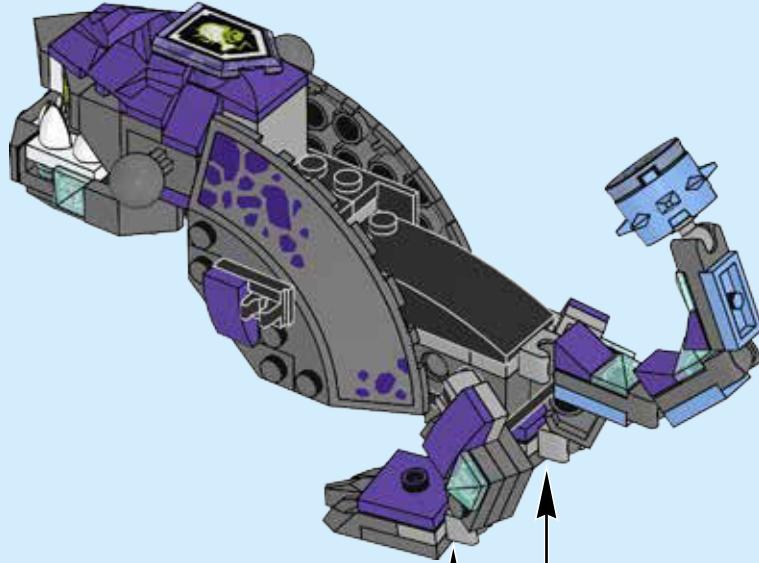



41

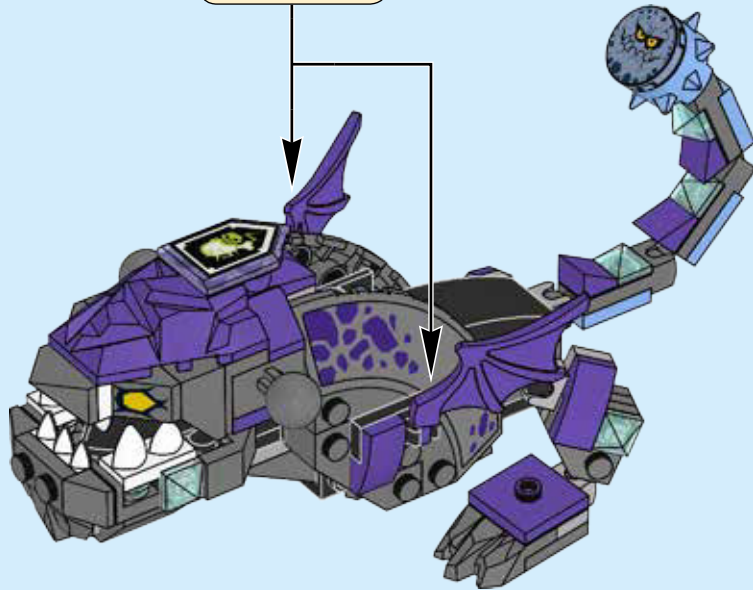
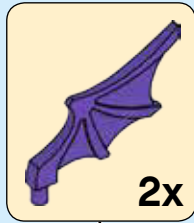





2x



2x

42

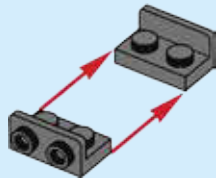

1x



1x

43

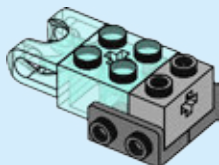

1x



2x

44

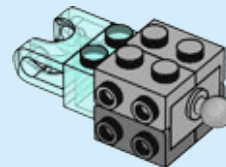

1x



2x

45

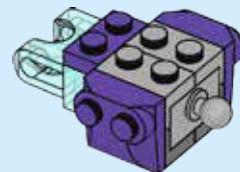



46

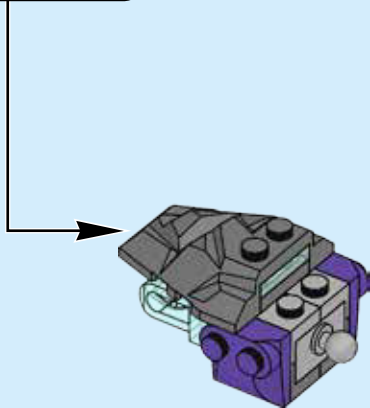

47

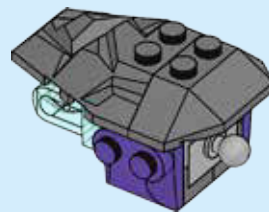

2x

48

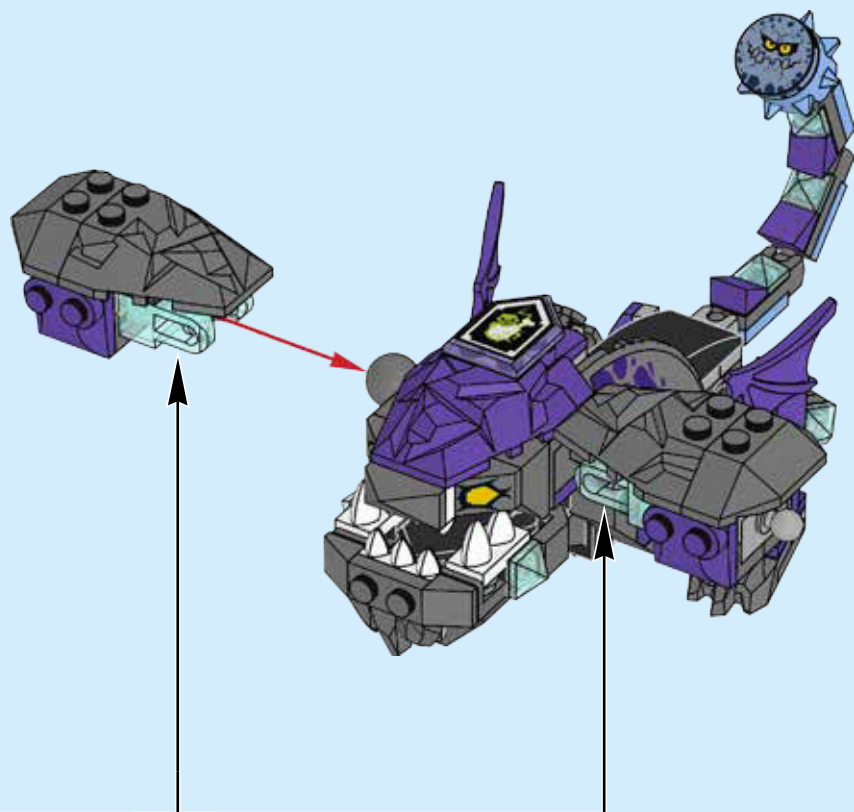



2x



1x

49



1x

50

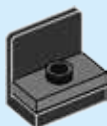

1x



1x

51

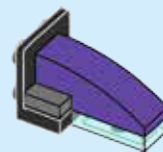
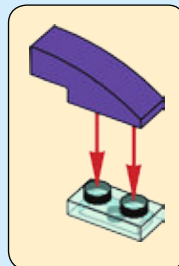

1x

52

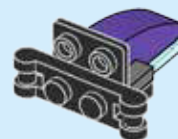



1x

53



1x



1x

54

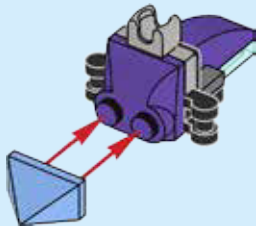

2x



2x

55

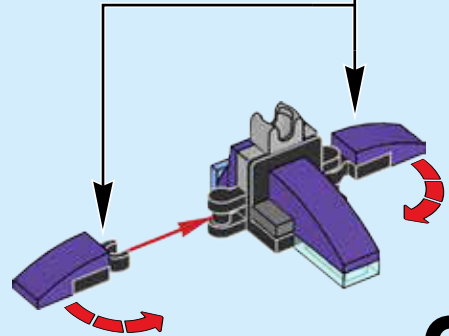
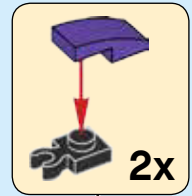

2x

56

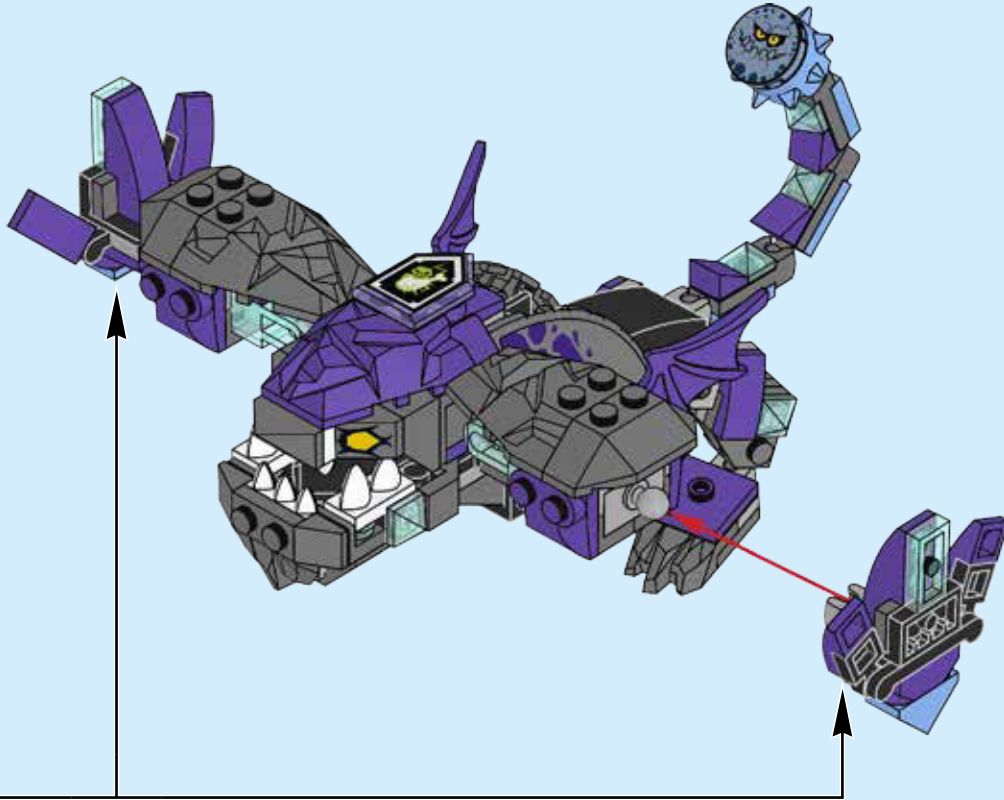

57



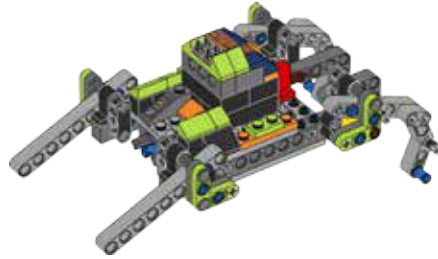
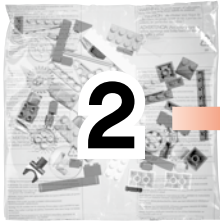

1x



1x



1x

1

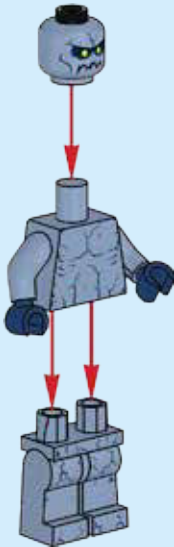

1x

2





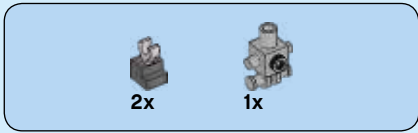

1

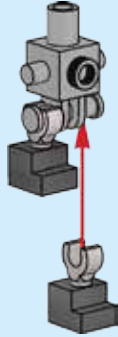

2

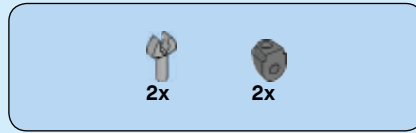

3

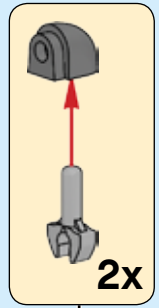
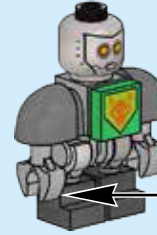

2x

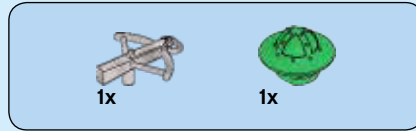

4





1x

**1**

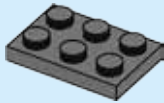

2x

**2**

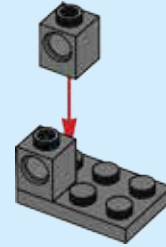

1x

**3**

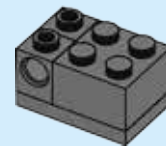

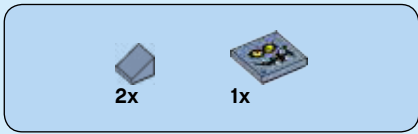

4

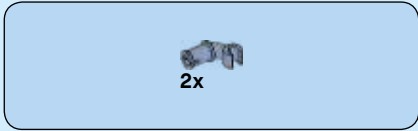
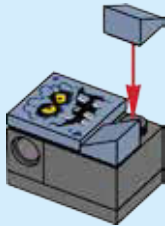

5

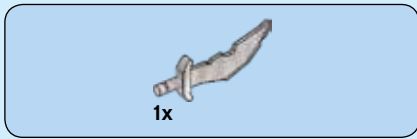
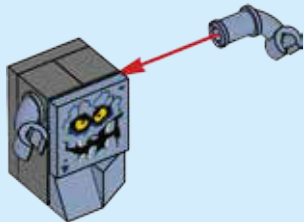
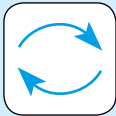

6



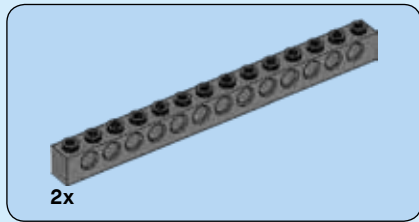
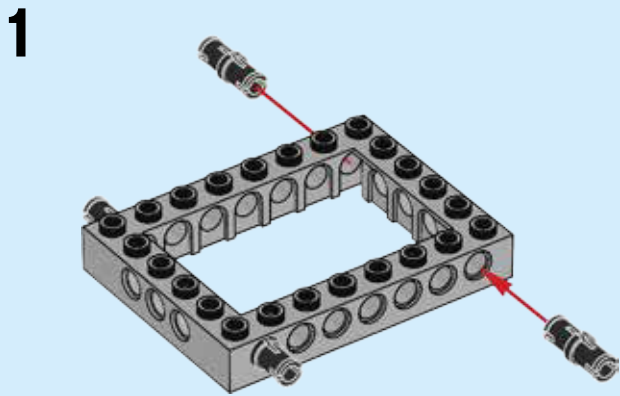
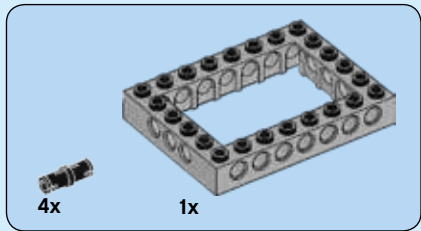
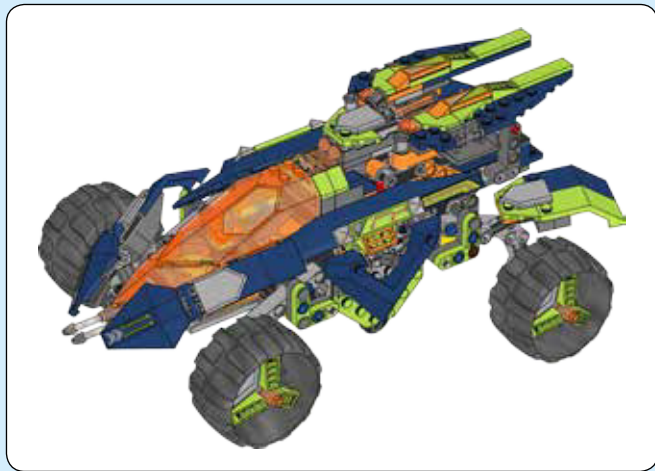

**2**

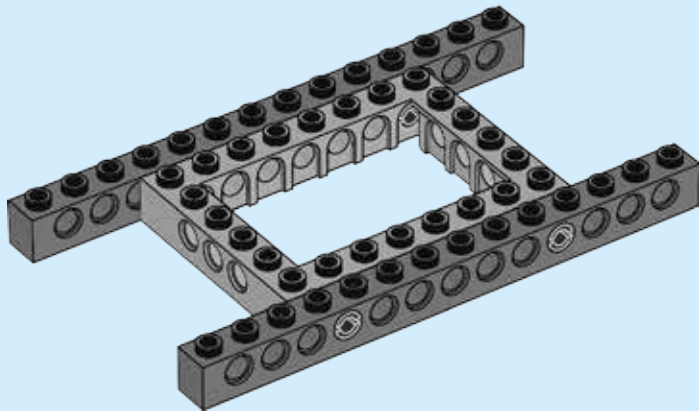

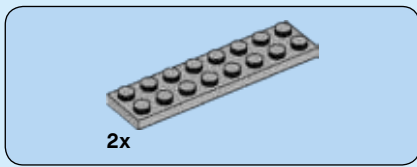

3

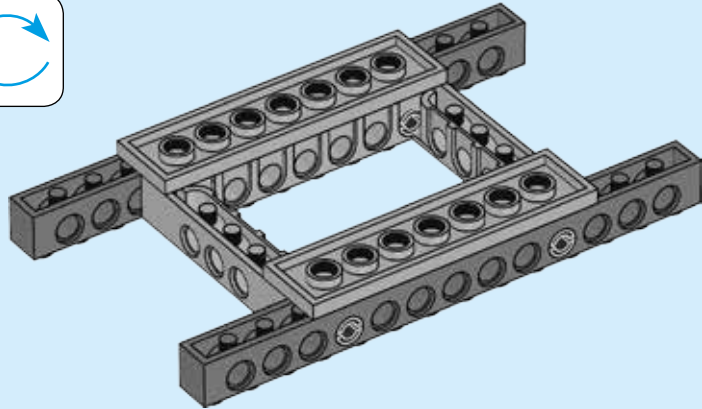
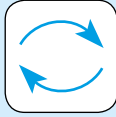

4

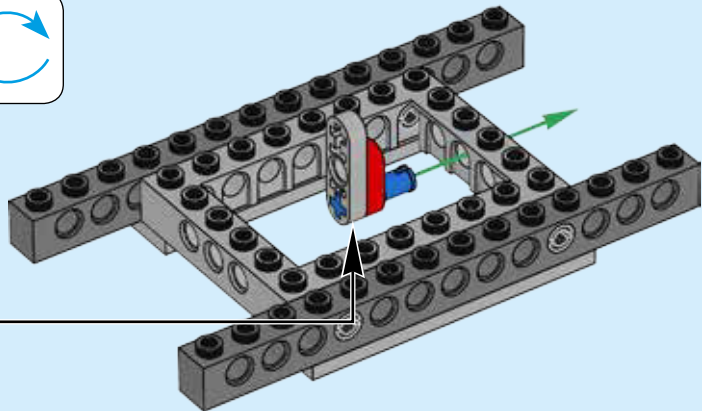
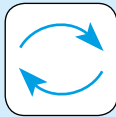
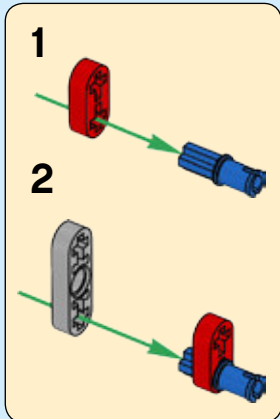



1x

5

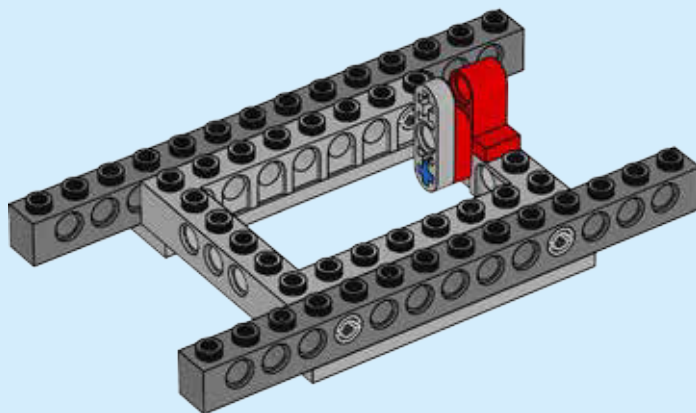

1x

3



3

1:1

6

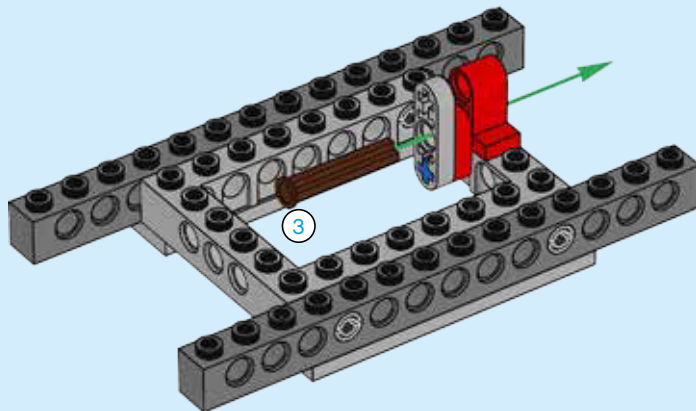



1x

7

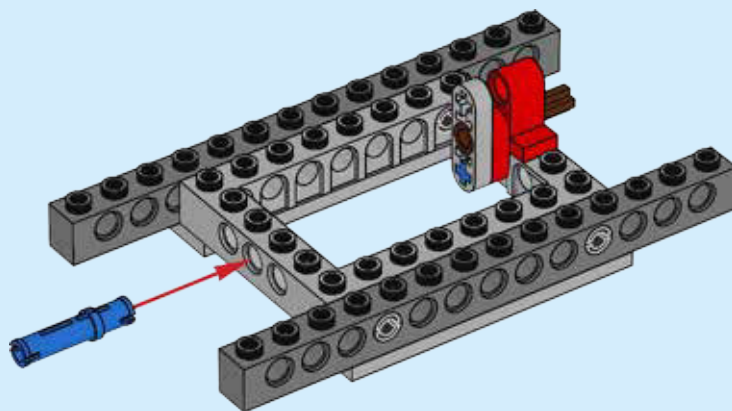

1x

8

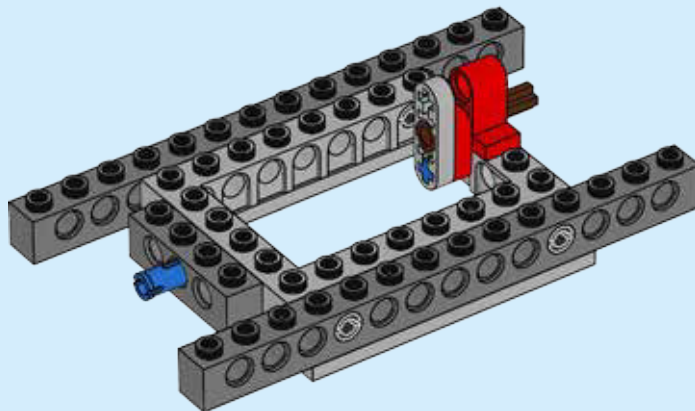



4x

9

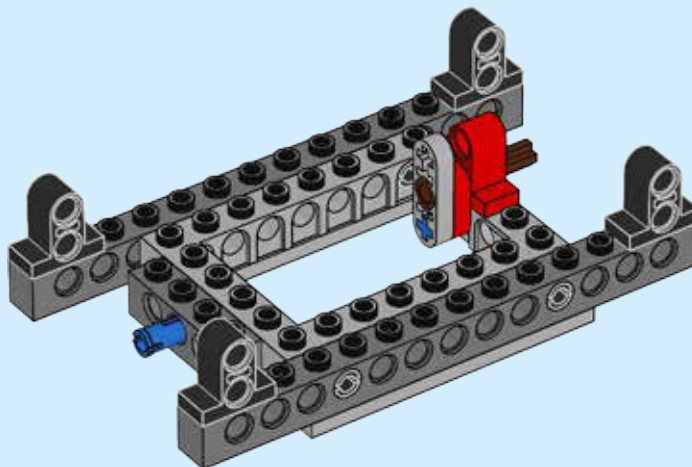

1x

10

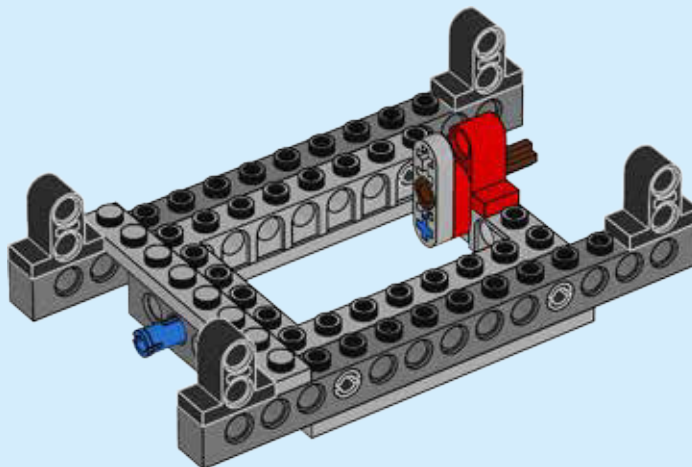



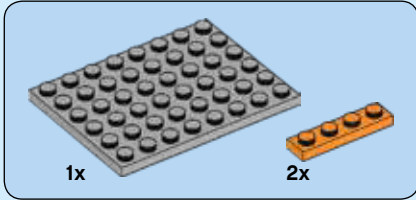
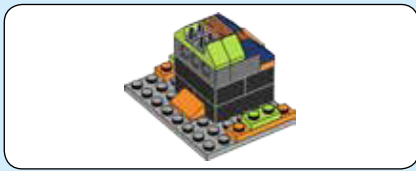

11

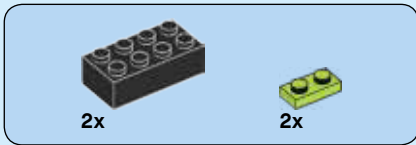
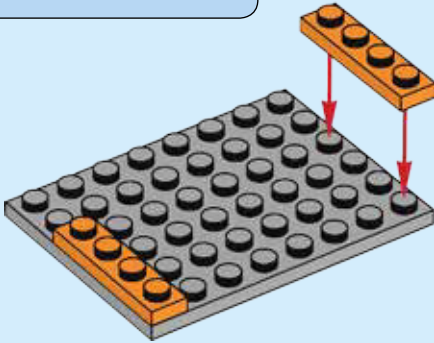

12

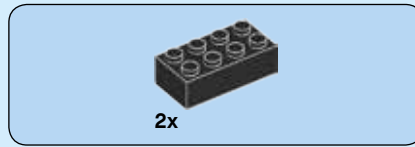
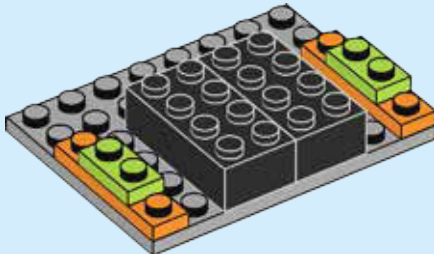

13

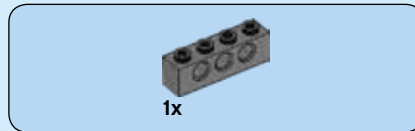
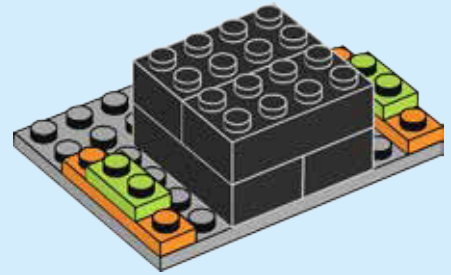

14

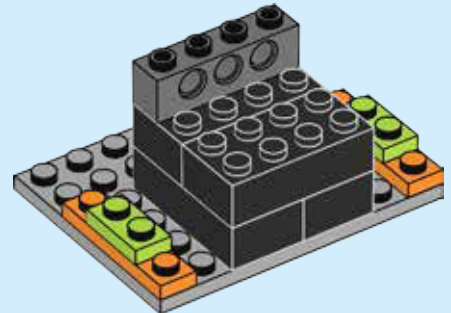

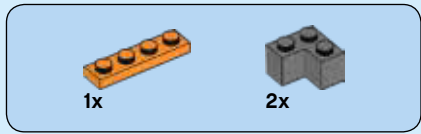

15

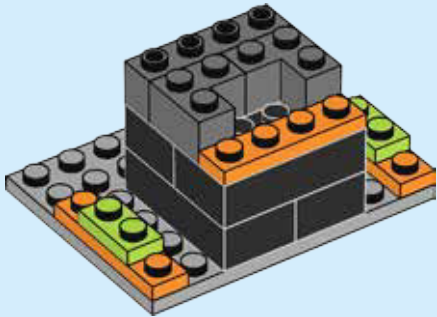

16

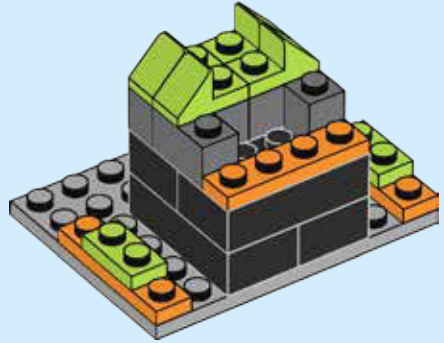

17

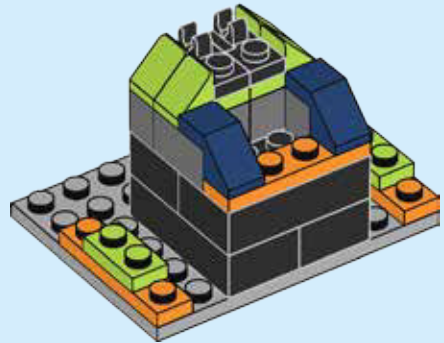



2x

18

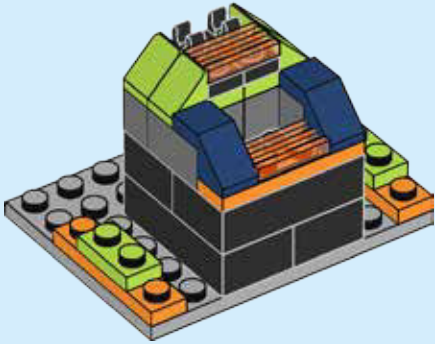

1x

19

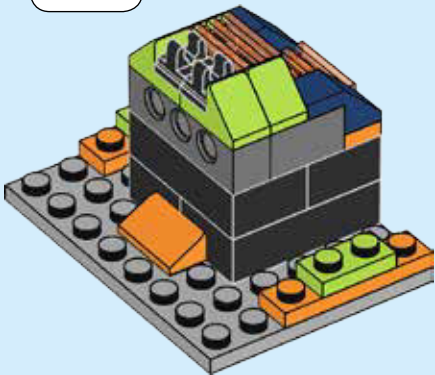
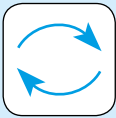

20

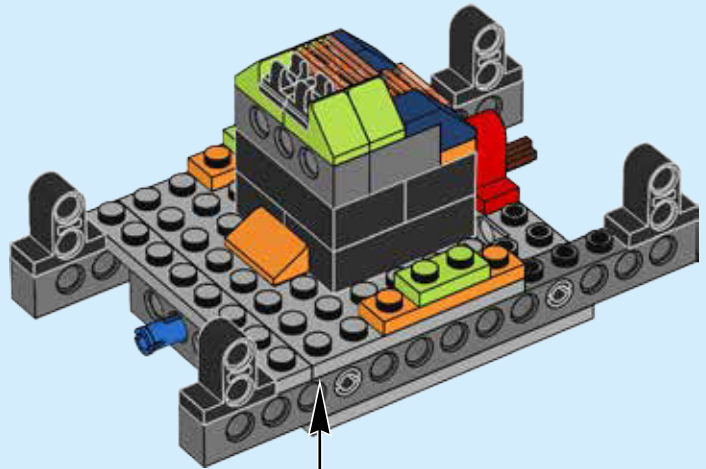

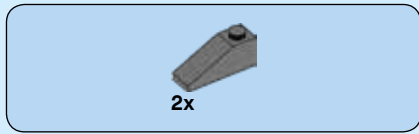

21

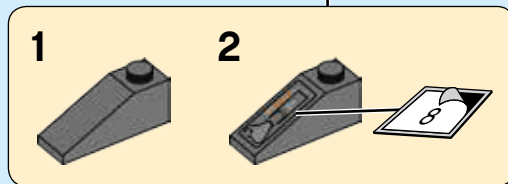
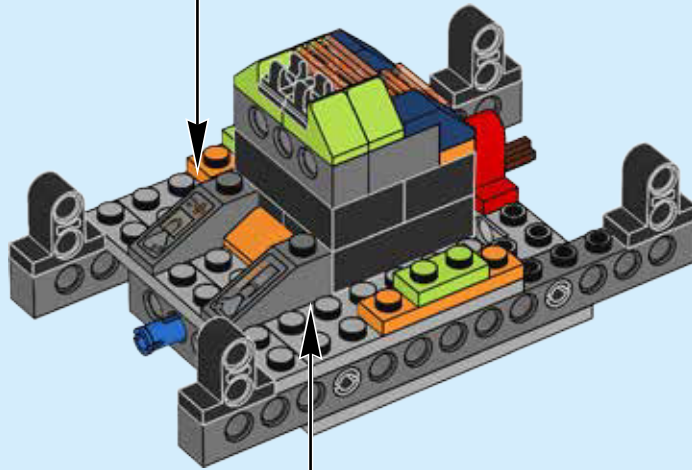
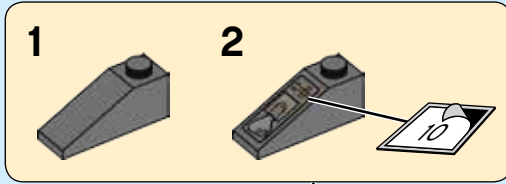



2x



2x

# 22

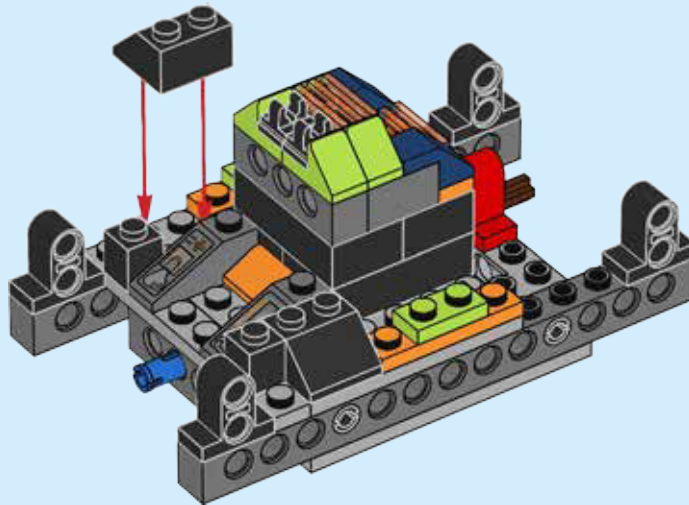

2x



2x

# 23

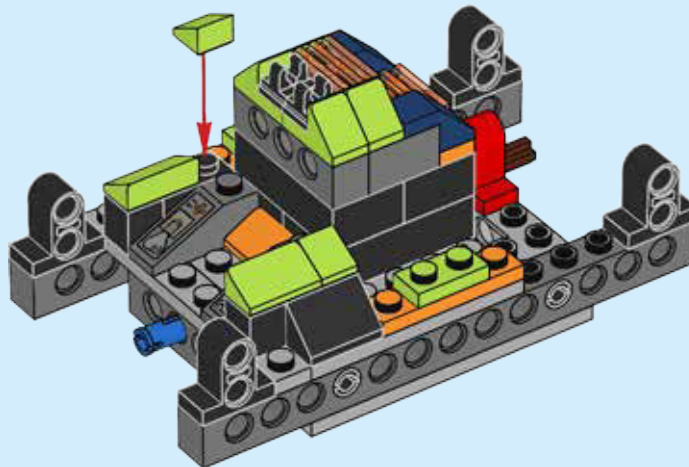

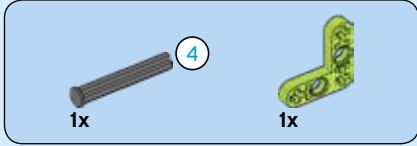
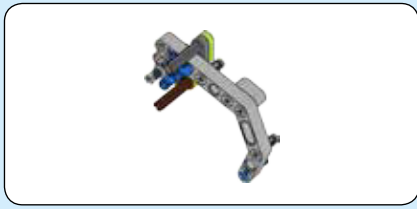

24

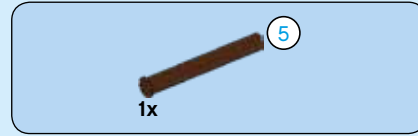
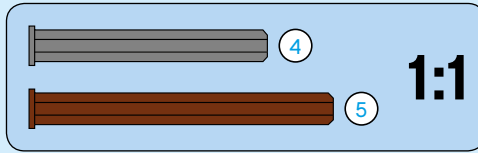
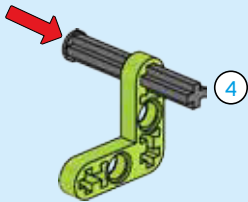

25

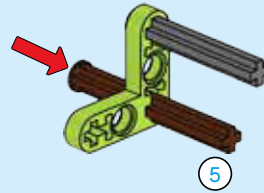

26

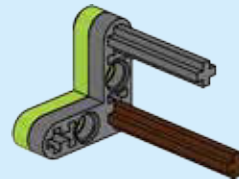



27

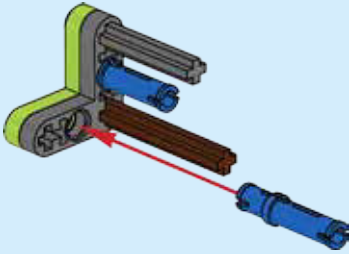

28

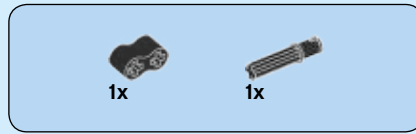
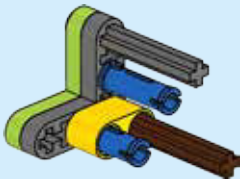

29

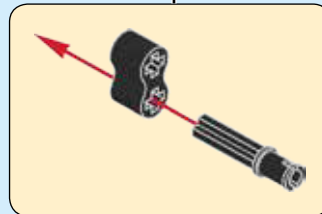
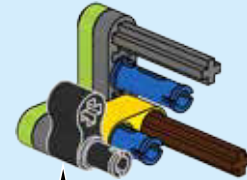

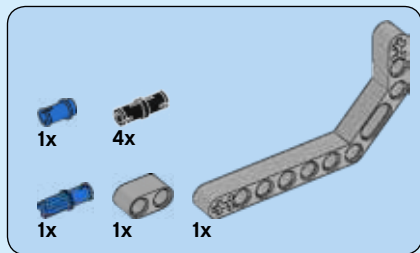

30

1

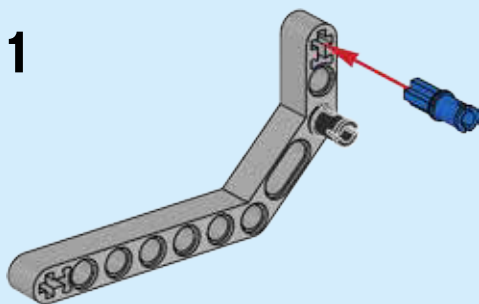

2

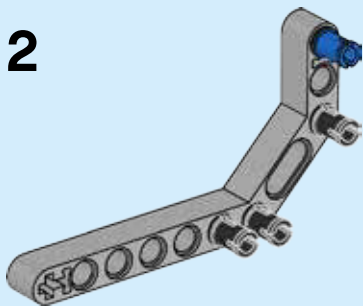

3

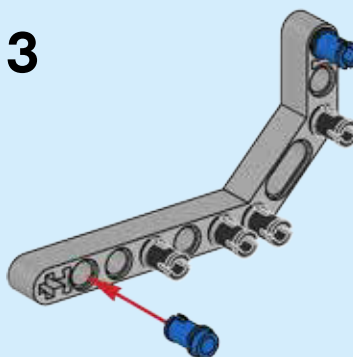

4

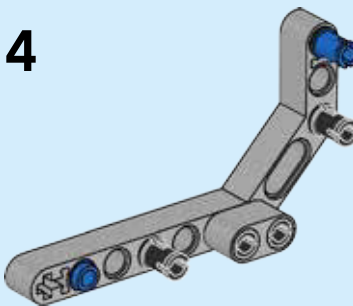



5

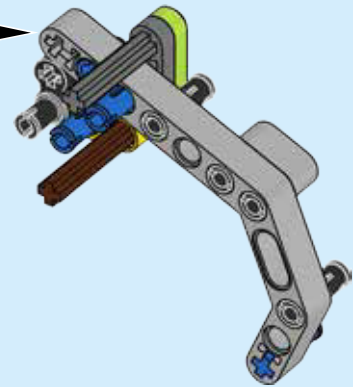
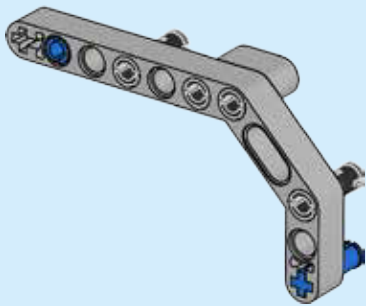
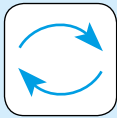

31

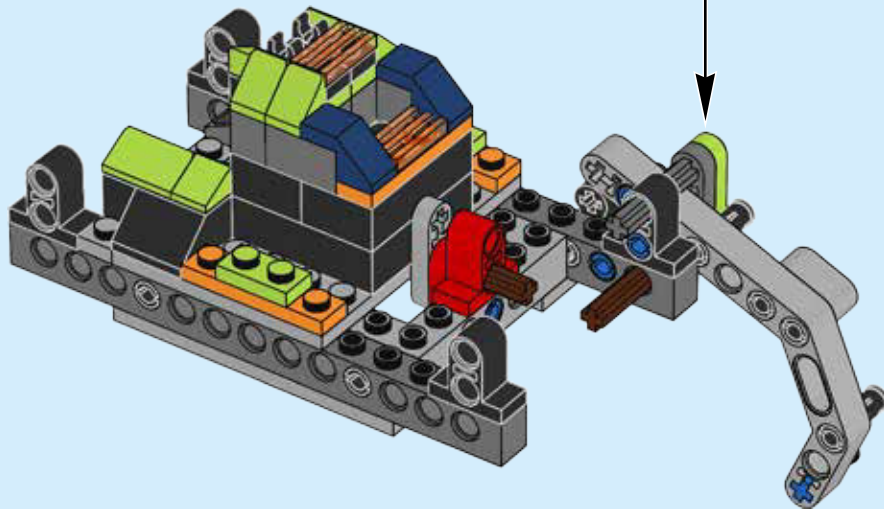

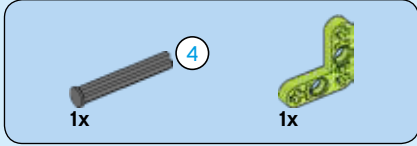
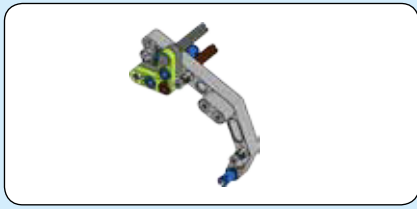

32

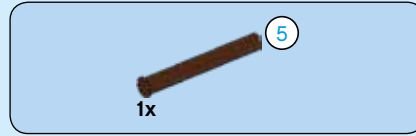
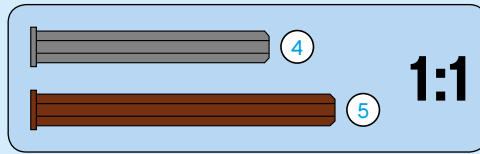
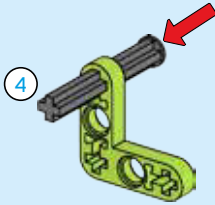

33

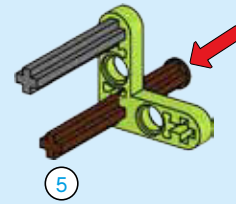

34

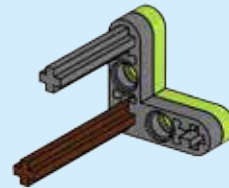



35

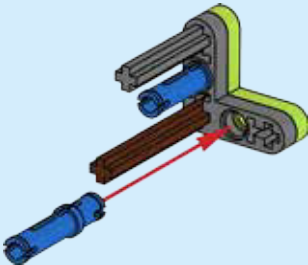

36

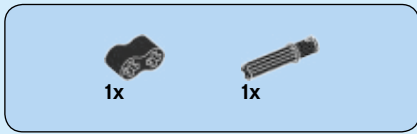
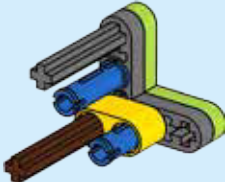

37

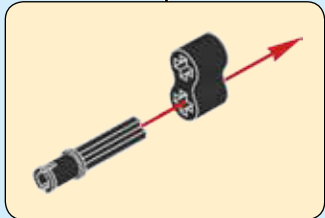
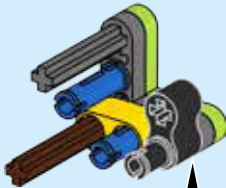

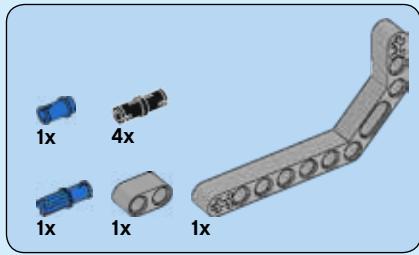

38

1

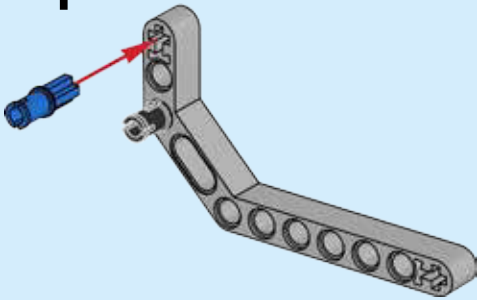

2

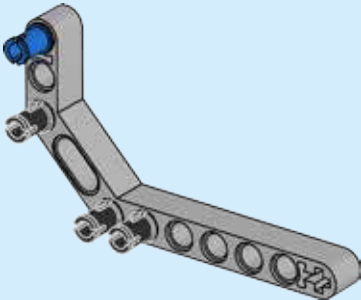

3

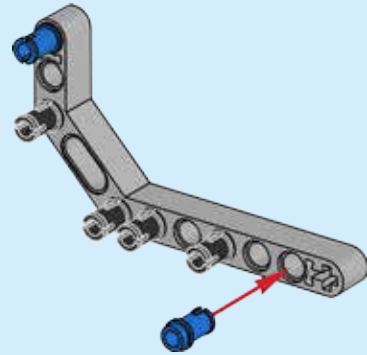

4

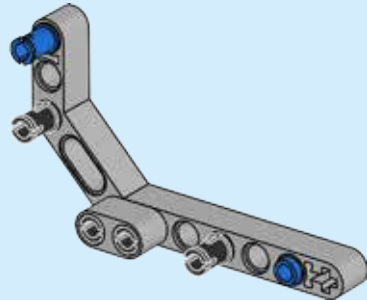

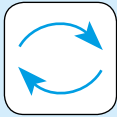

5

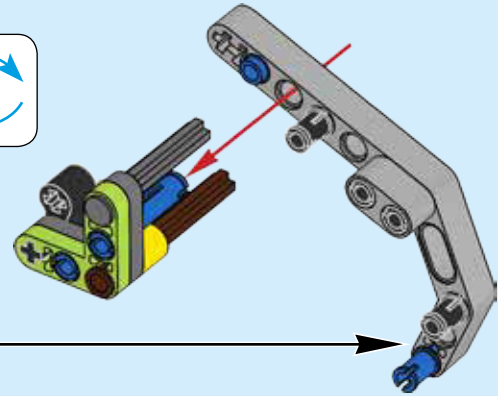
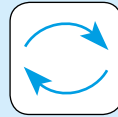
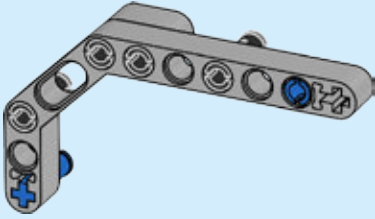

39

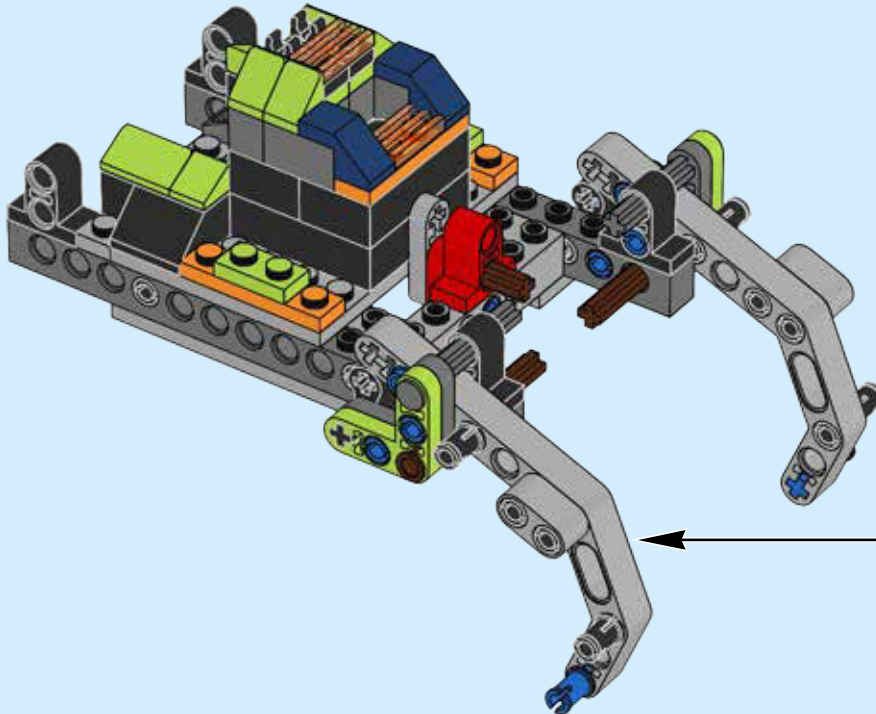



2x

40

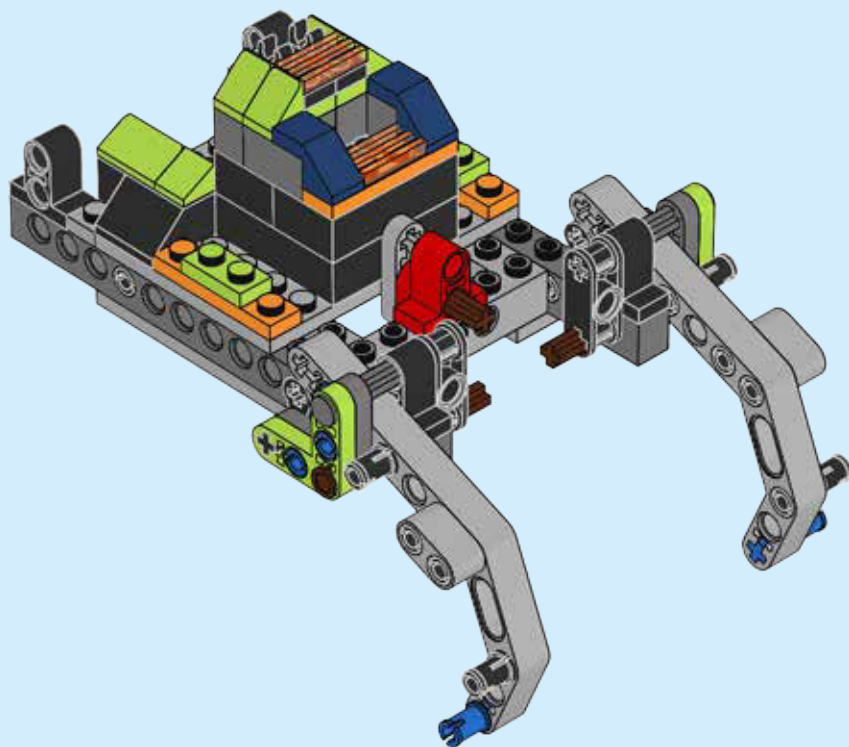

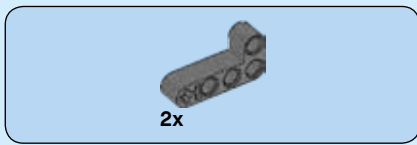

41

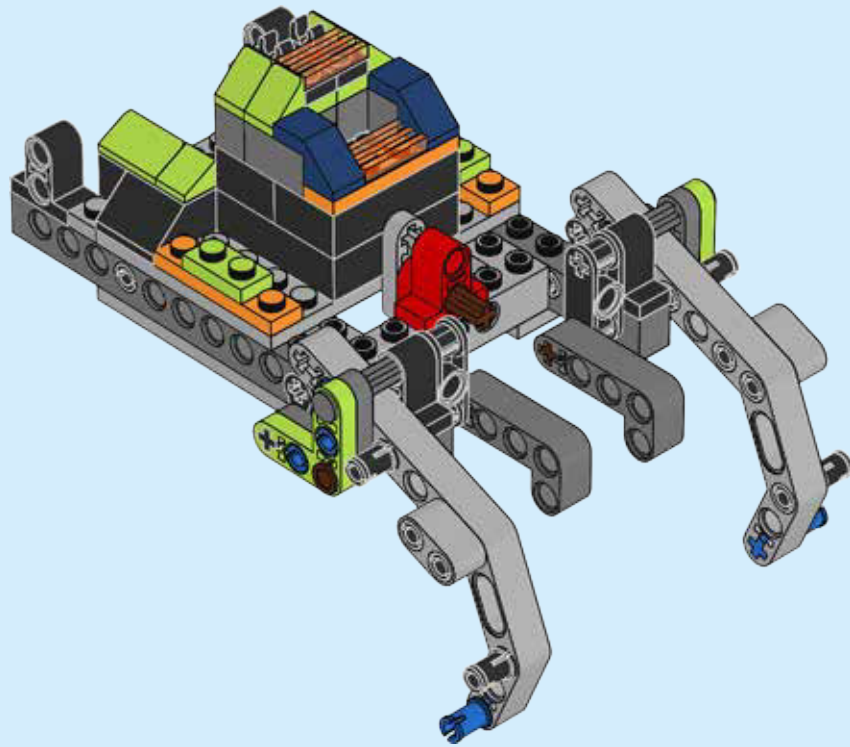

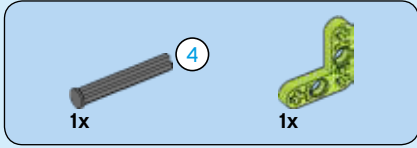
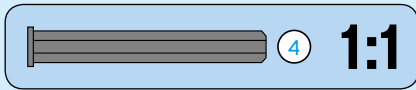

42

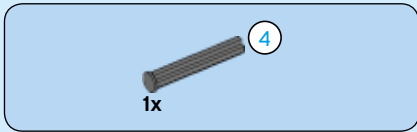
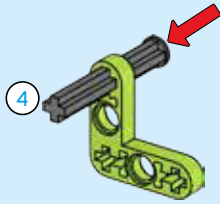

43

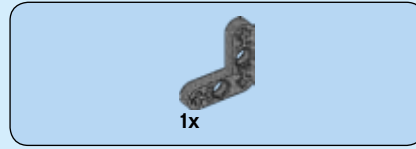
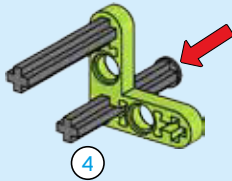

44

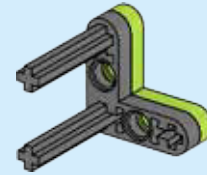

45

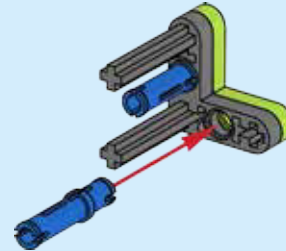





46

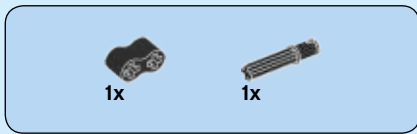
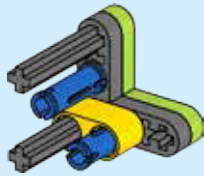

47

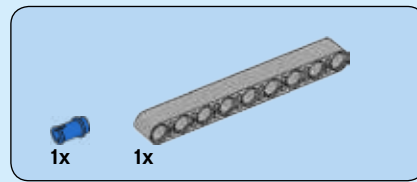
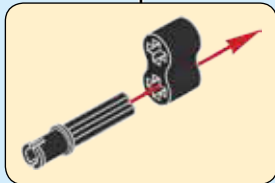
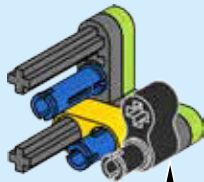

48

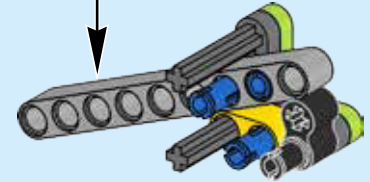
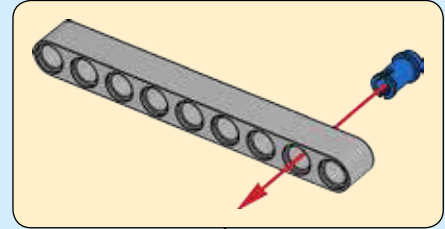

49

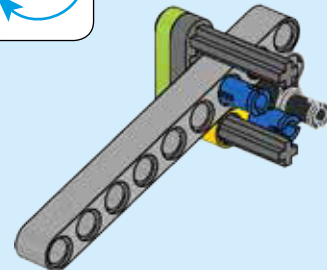
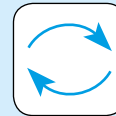

50

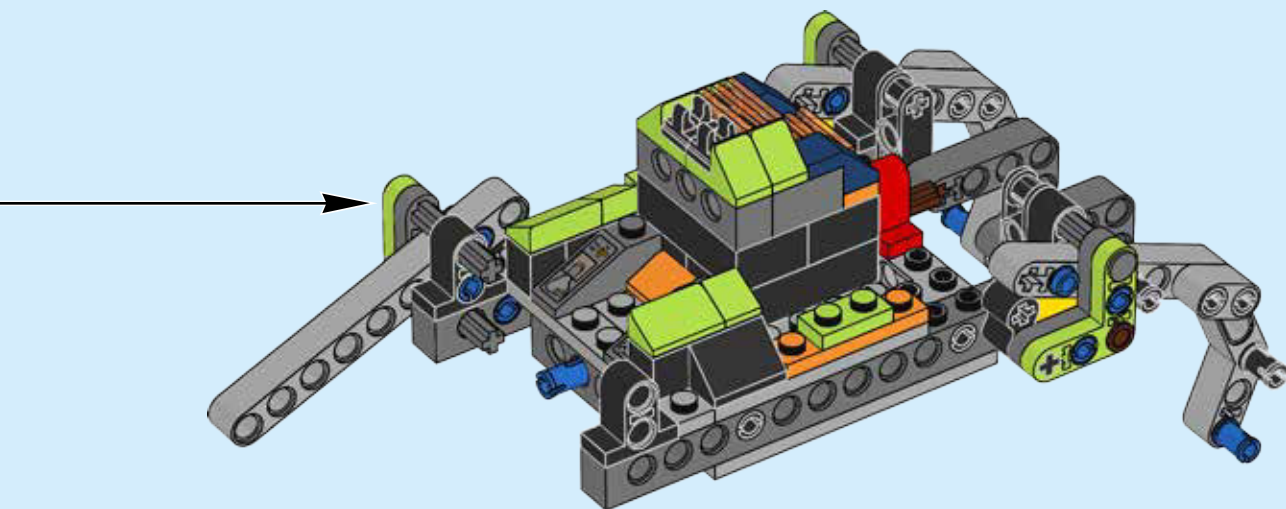

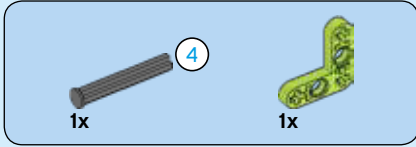

51

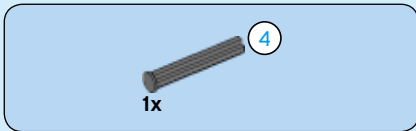
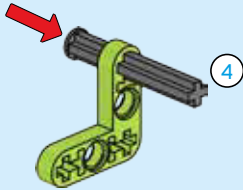

52

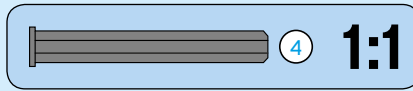
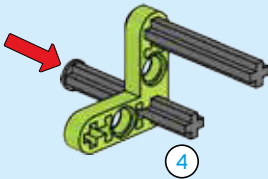

53

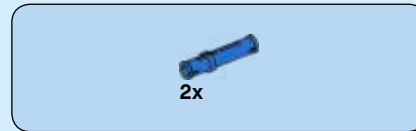
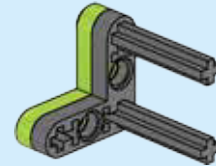
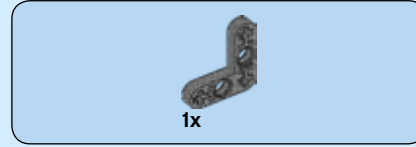

54

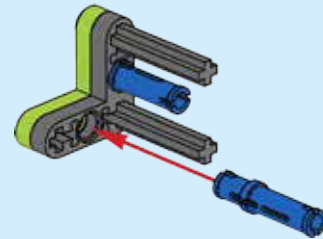



55

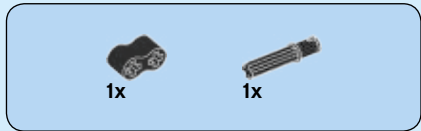
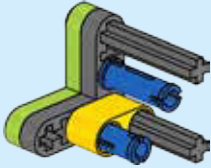

56

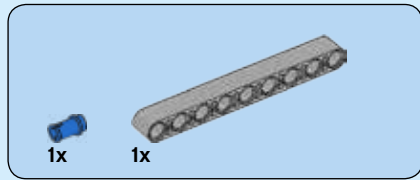
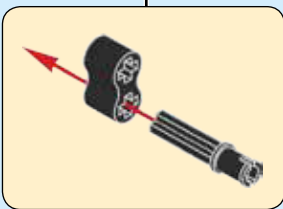
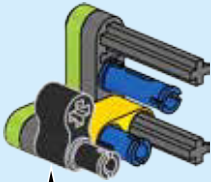

57

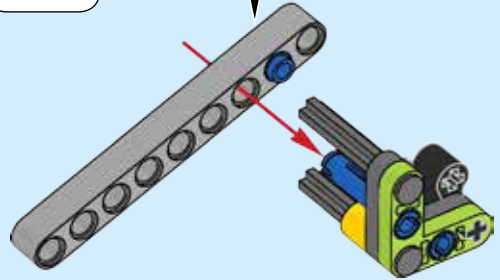
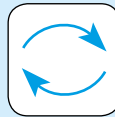
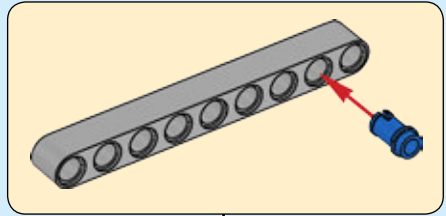

58

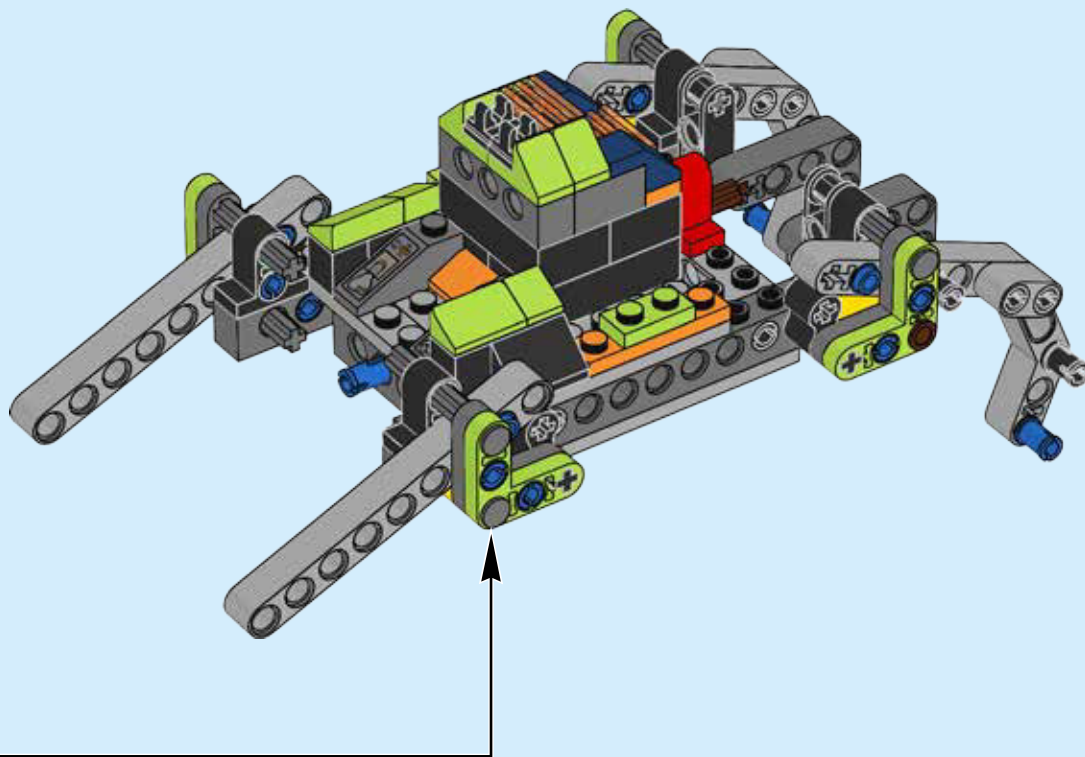



2x

59

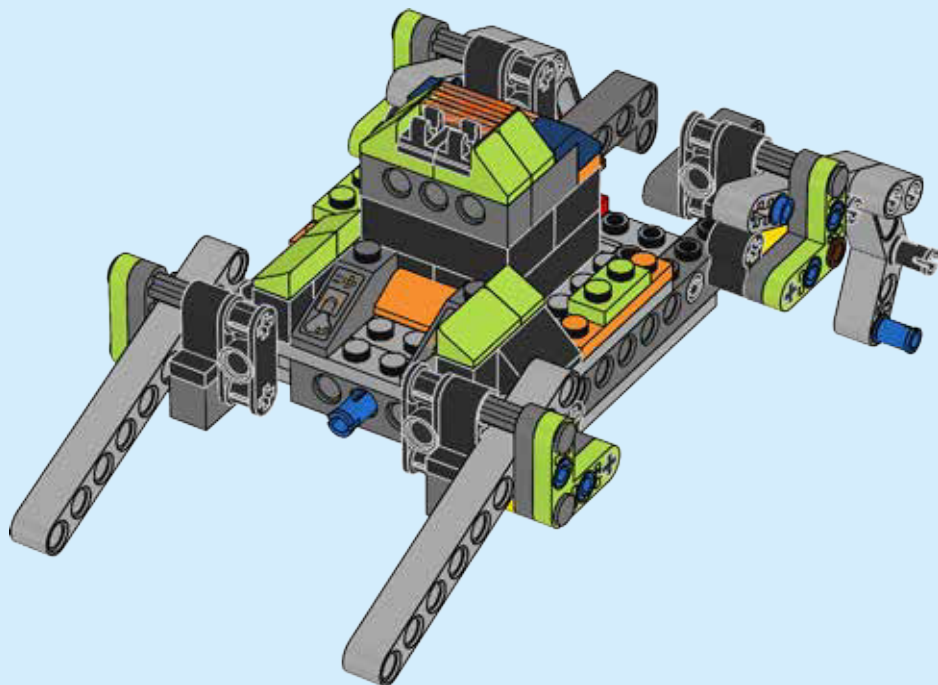



2x

60

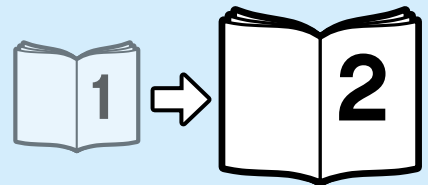
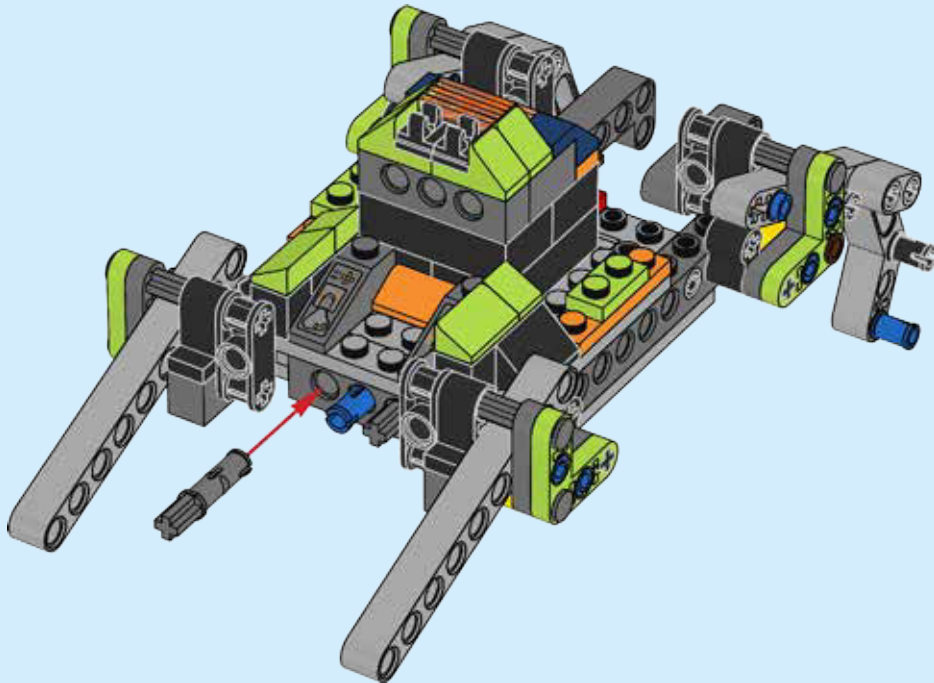



# WIN

GO TO [WWW.LEGO.COM/PRODUCTFEEDBACK](http://www.LEGO.COM/PRODUCTFEEDBACK) AND  
GIVE US YOUR SHORT **FEEDBACK** ABOUT THIS  
LEGO® SET FOR A CHANCE TO WIN  
A COOL LEGO PRIZE.

Terms & Conditions apply

# LEGO.com/productfeedback

## GEWINNE

Erzähle uns auf  
[www.LEGO.com/productfeedback](http://www.LEGO.com/productfeedback)

etwas über die Erfahrungen, die du mit  
diesem LEGO® Set gemacht hast, und  
sichere dir die Chance auf einen coolen  
LEGO Preis!

Es gelten die Teilnahmebedingungen

## GAGNE

Rends-toi sur  
[www.LEGO.com/productfeedback](http://www.LEGO.com/productfeedback)

et donne-nous quelques commentaires  
sur ce produit LEGO® pour avoir une  
chance de gagner un prix LEGO !

Voir Conditions Générales

## GANAN

Visita  
[www.LEGO.com/productfeedback](http://www.LEGO.com/productfeedback)

y envíanos tu opinión acerca de este set  
LEGO®. ¡Participarás en el sorteo de un  
premio LEGO!

Términos y Condiciones aplicables

## 获取奖品

登录  
[www.LEGO.com/productfeedback](http://www.LEGO.com/productfeedback)

给出关于此乐高®套装的简短反馈，  
就有机会获得炫酷乐高奖品

《条款及条件》适用



**LEGO**

# NEXO KNIGHTS



70355



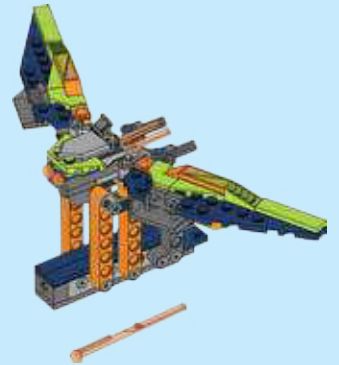
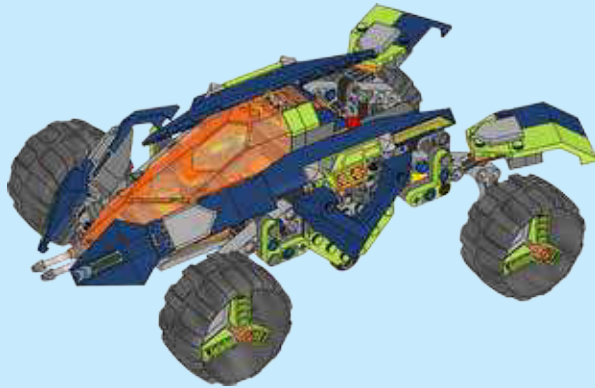
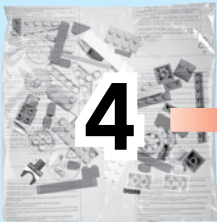
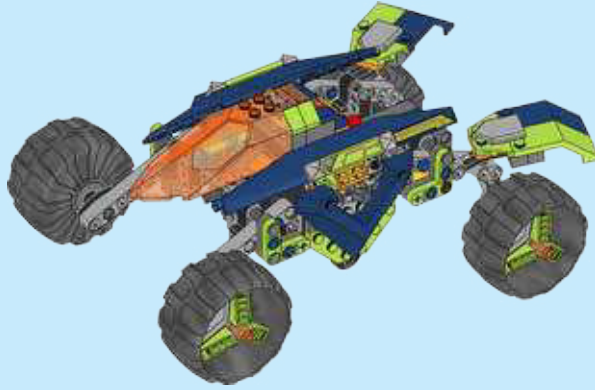
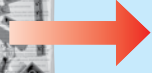



4x

+

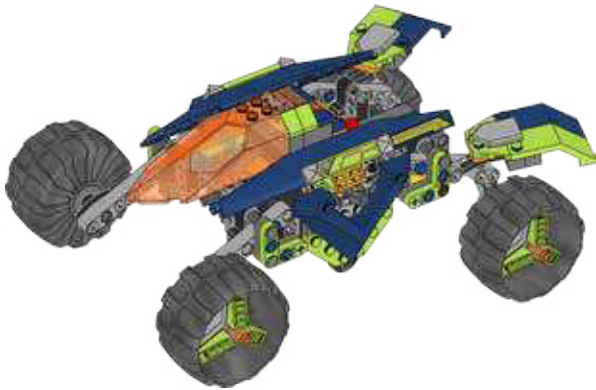

2x

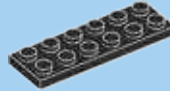

1x



1x

61

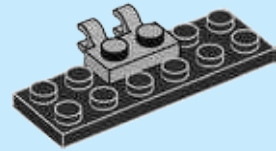

2x

62

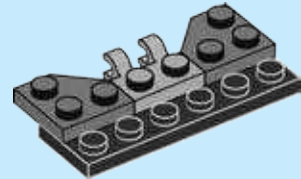

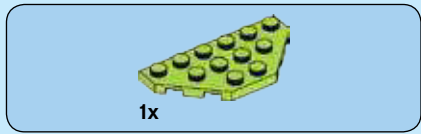

63

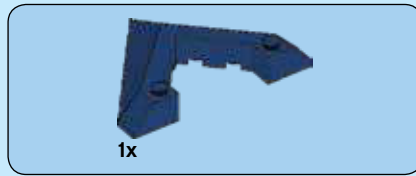
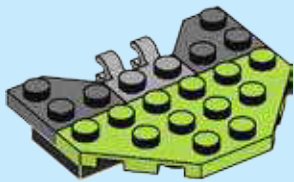

64

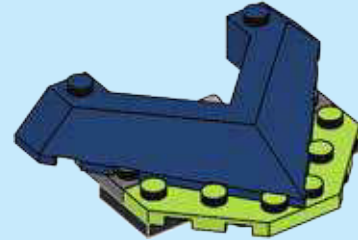

65

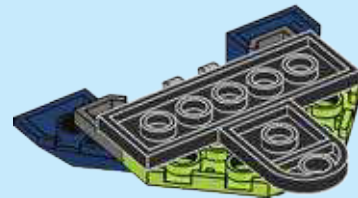
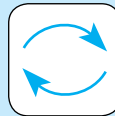





3x

66

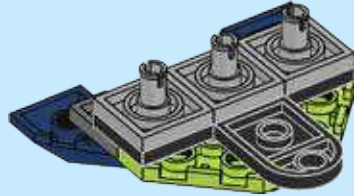

2x

67

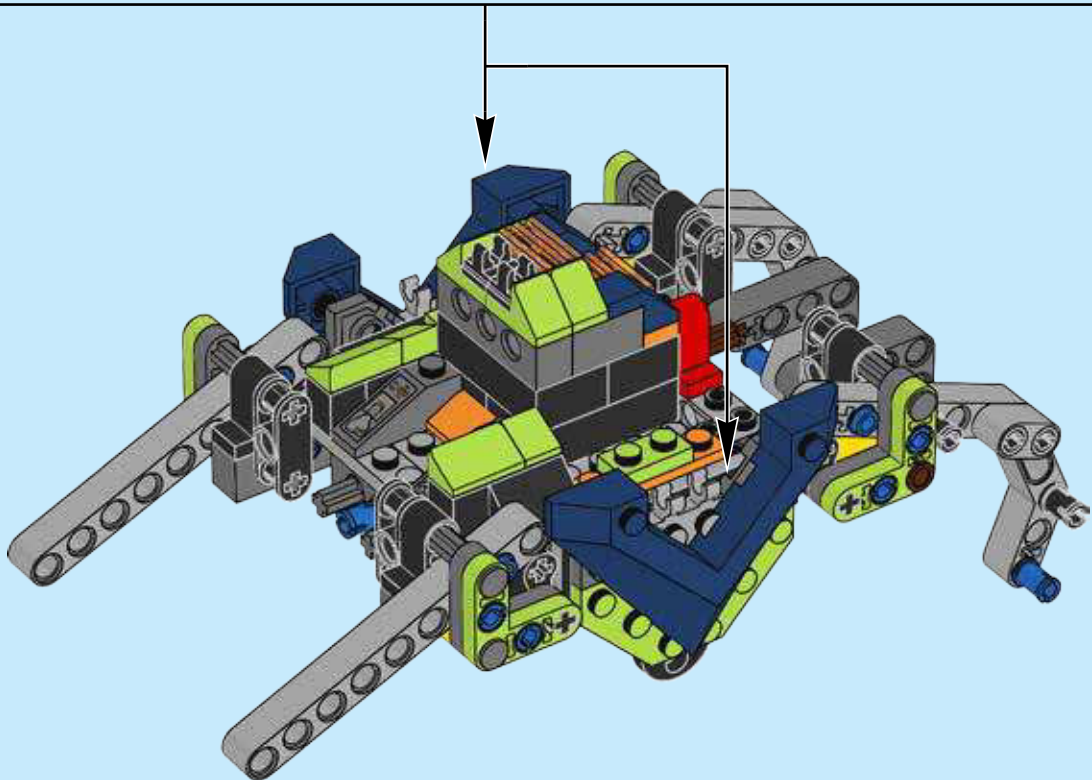

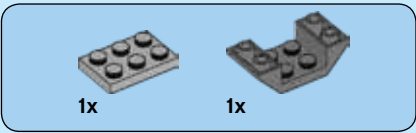
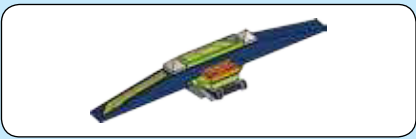

68

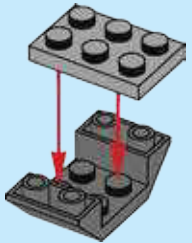

69

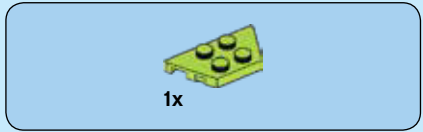

70

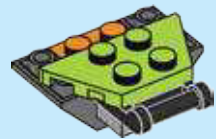

71

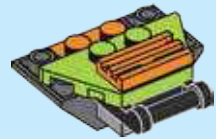

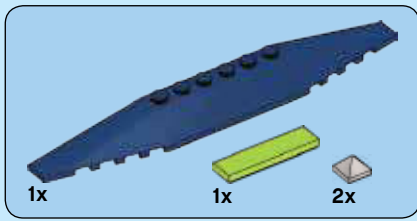

72

1

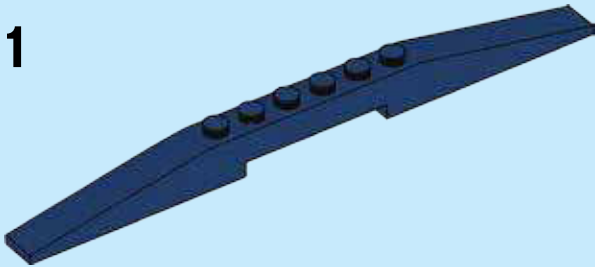

2

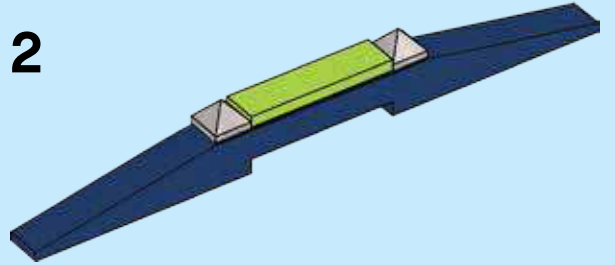

3

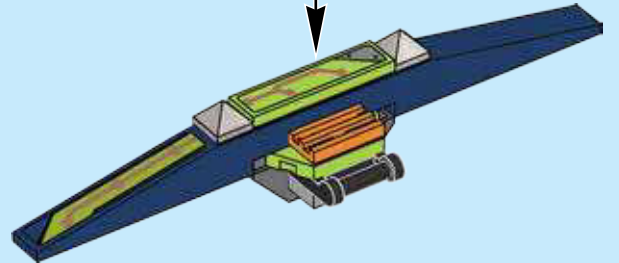
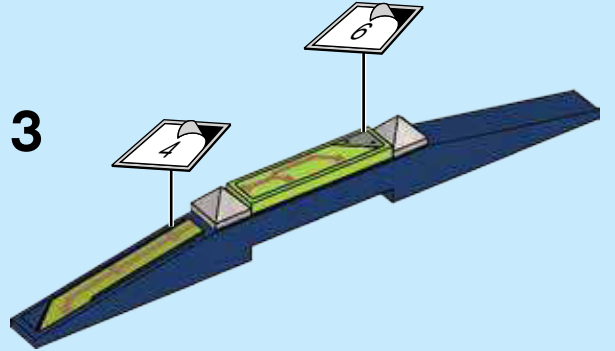

73

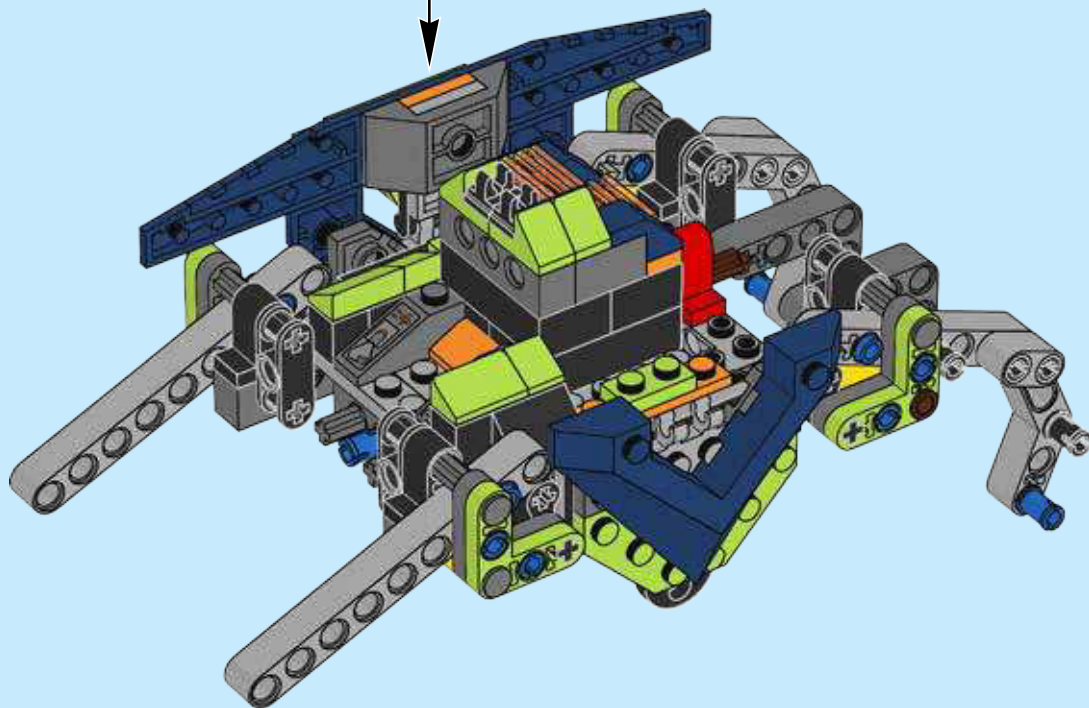



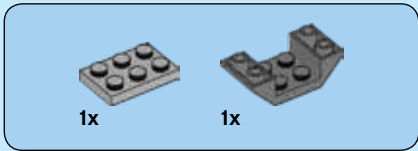
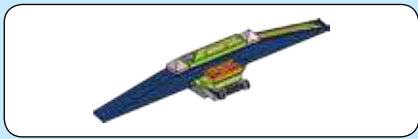

74

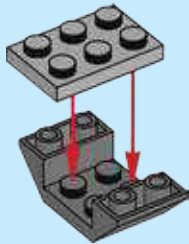

75

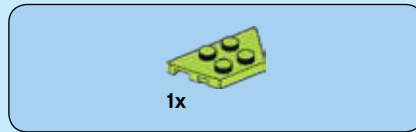
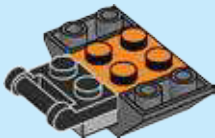

76



77

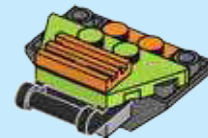

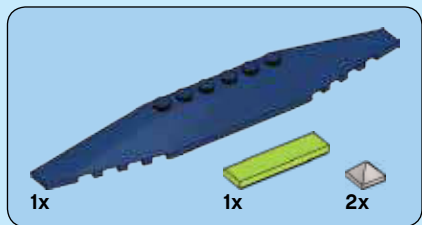

78

1

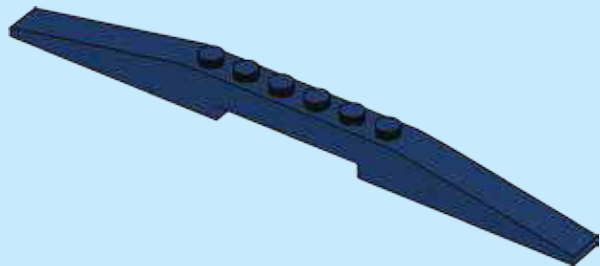

2

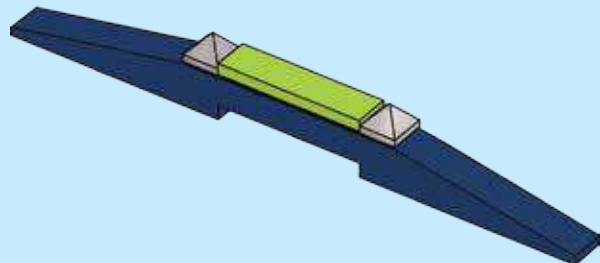

3

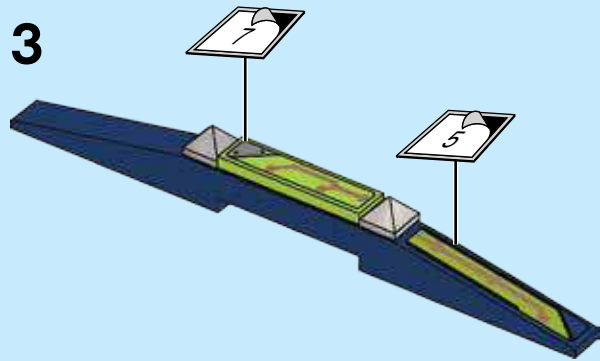

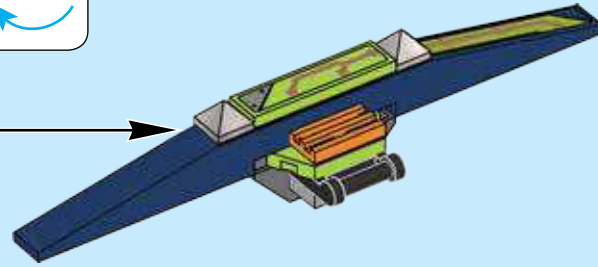
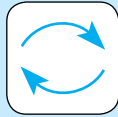

79

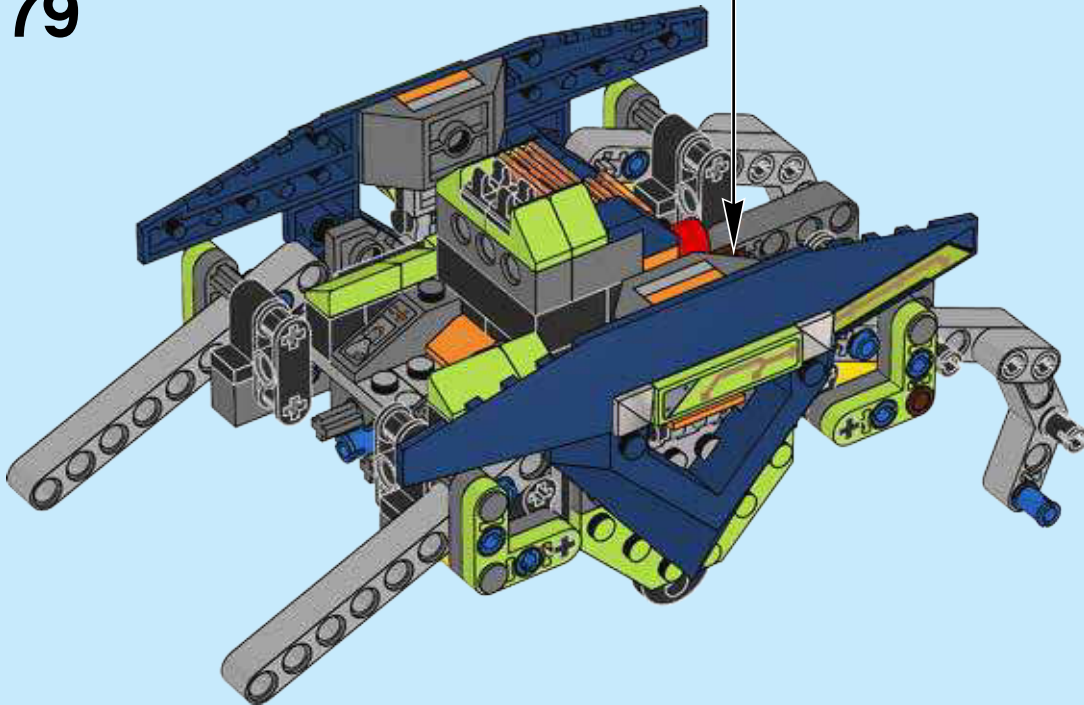

80

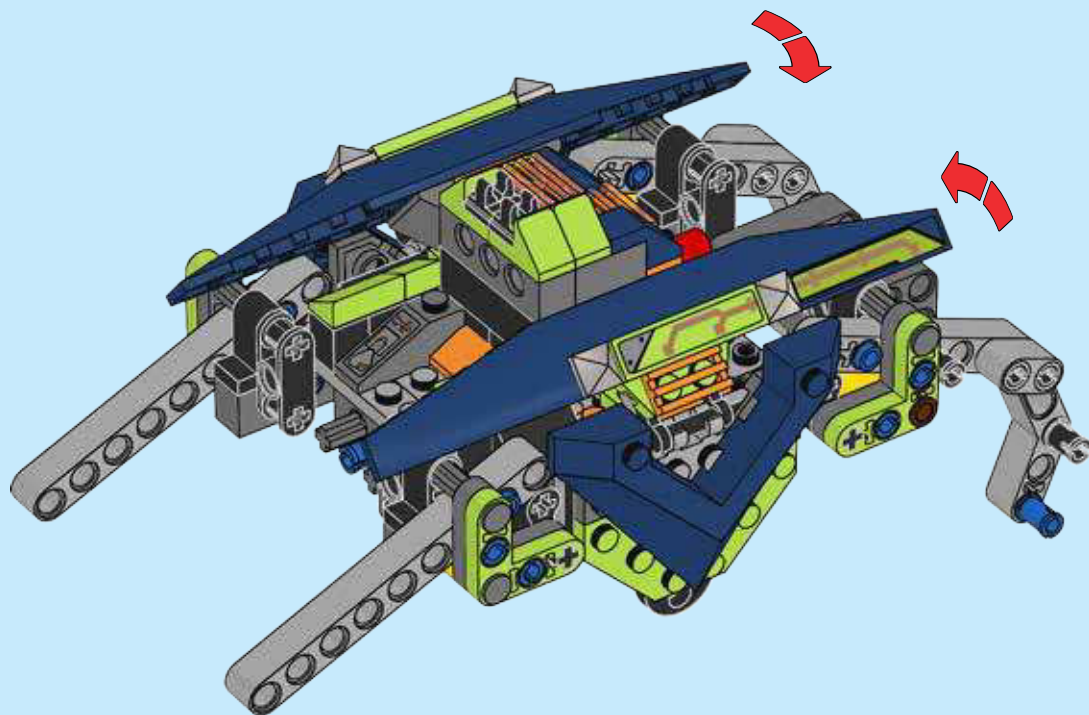



81

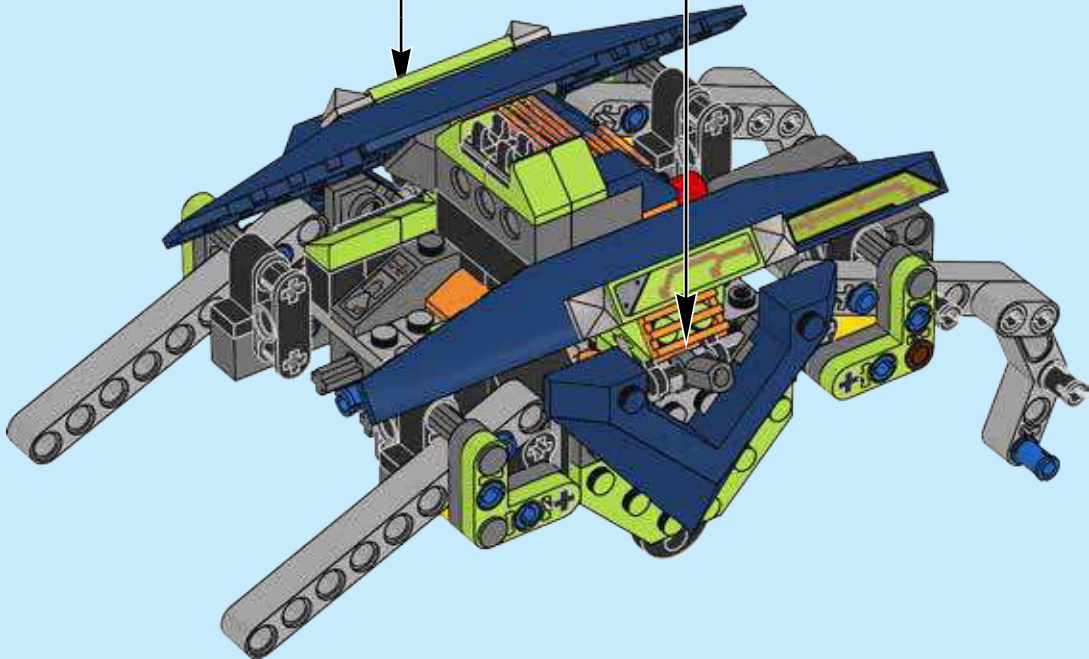

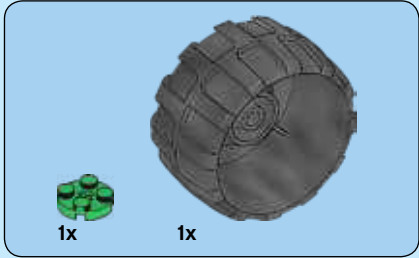

82

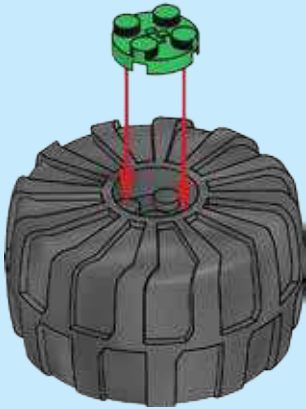

83

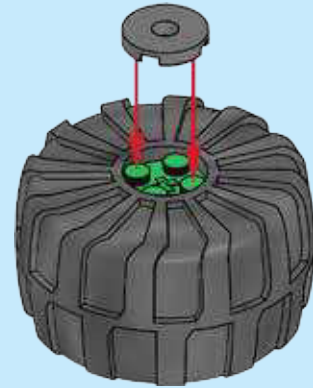

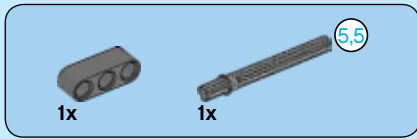

84

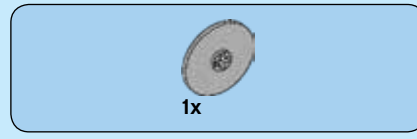
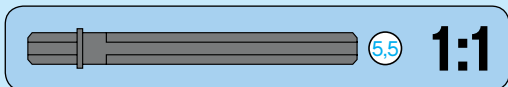
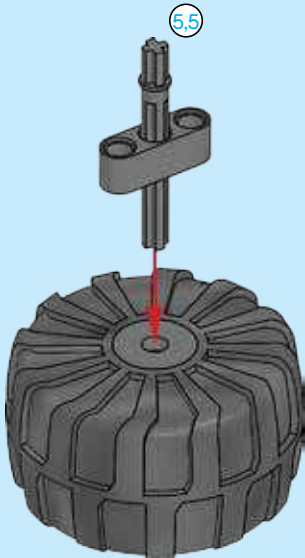

85

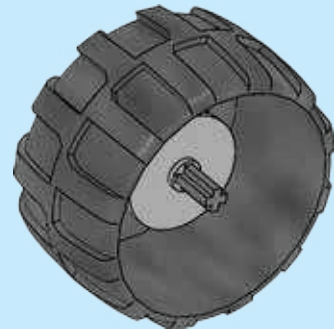
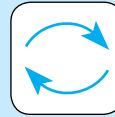



86

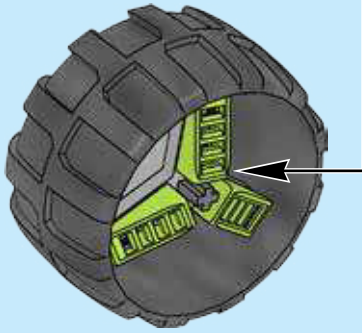
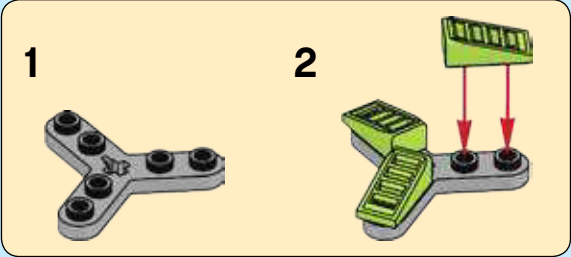

87

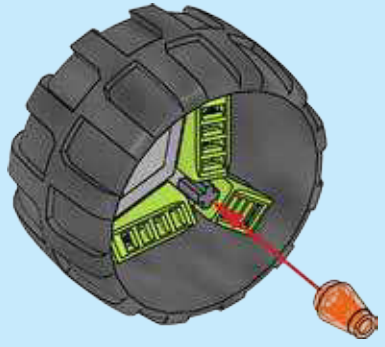

2x



88

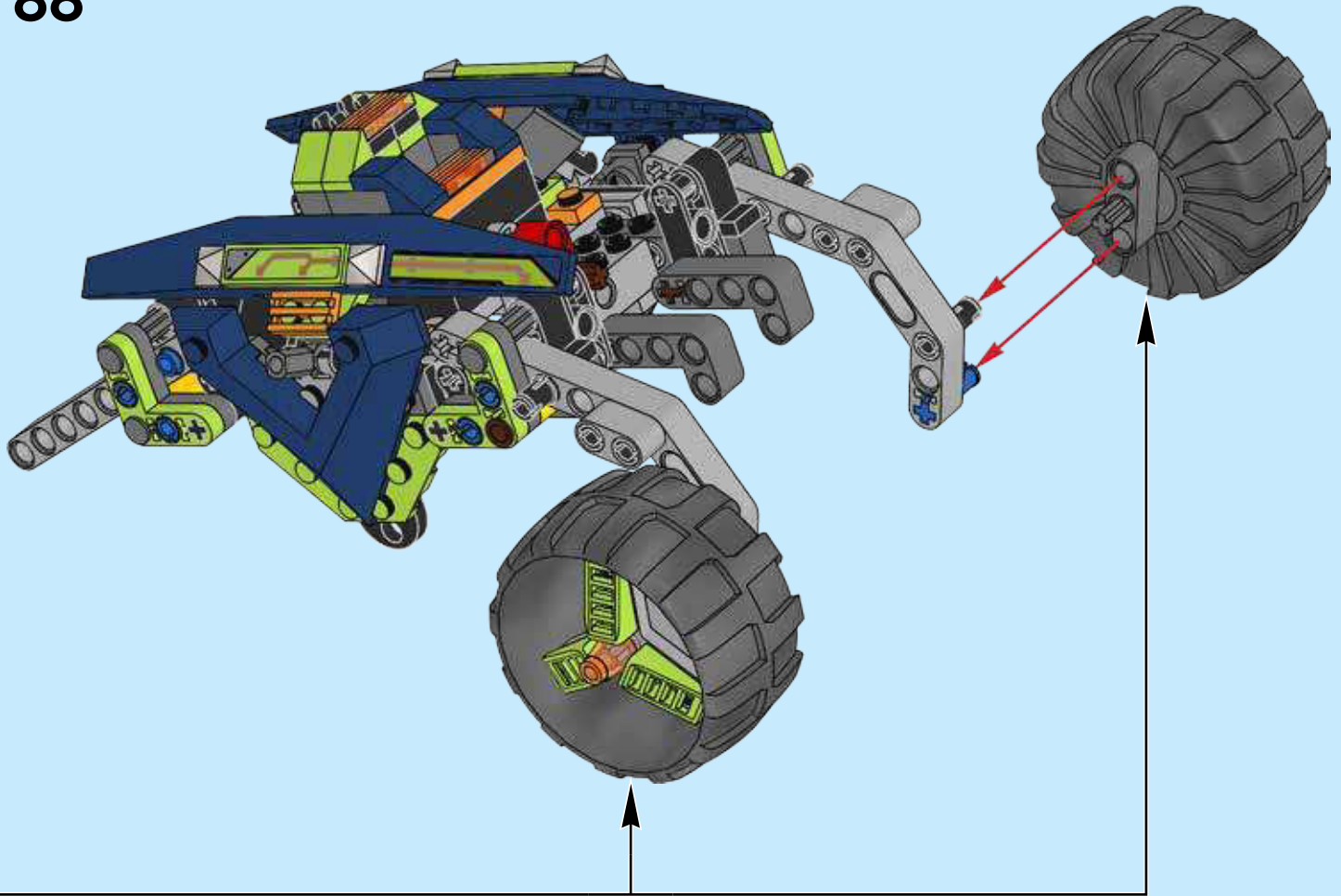

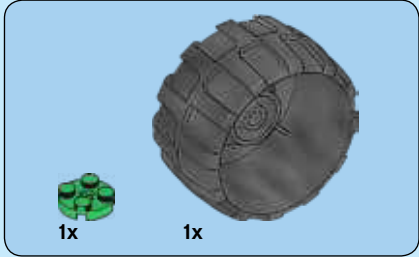

89

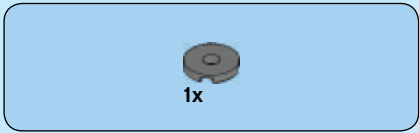
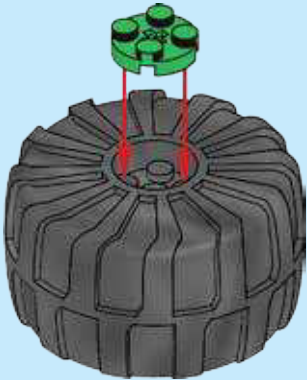

90

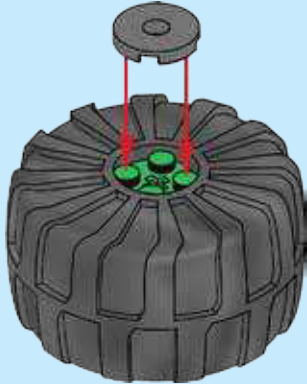

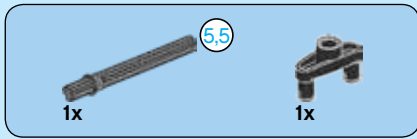

91

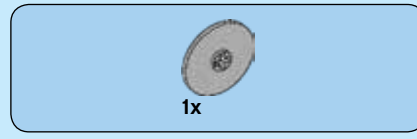
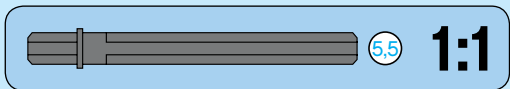
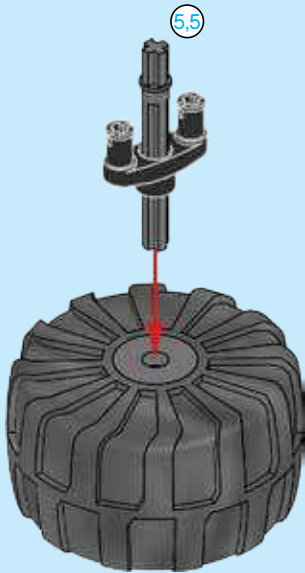

92

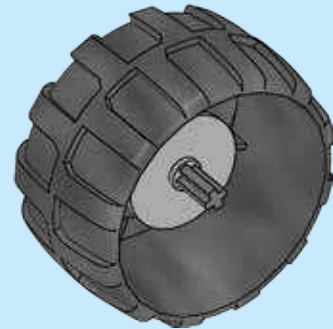
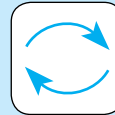

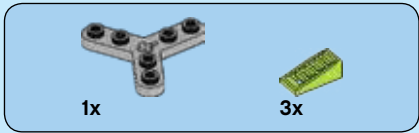

93

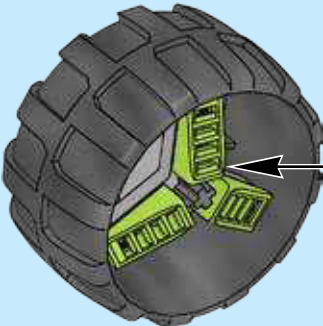
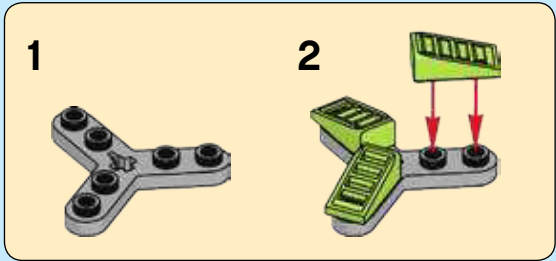

94

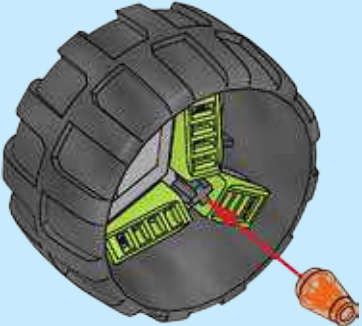

2x

95

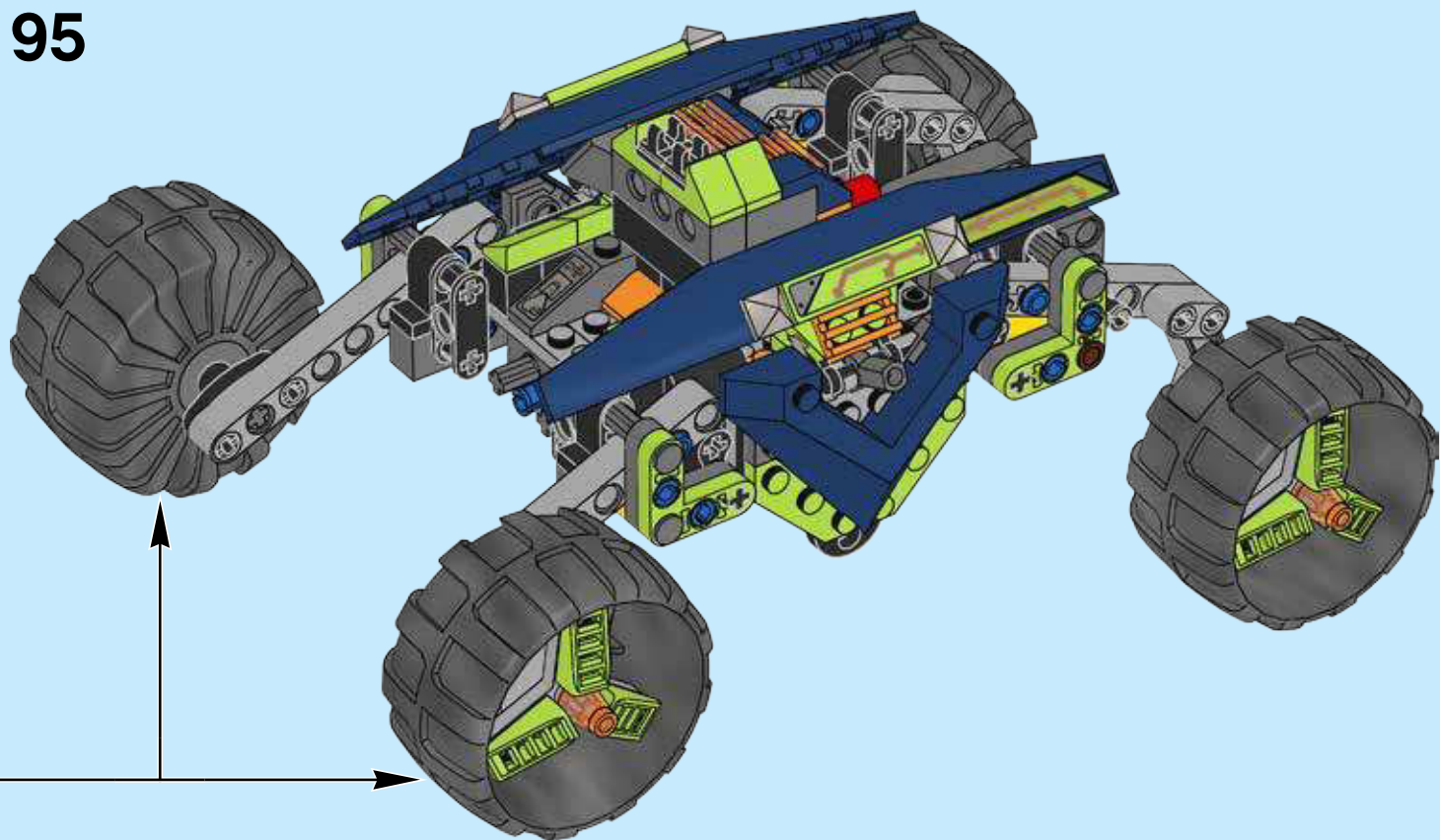

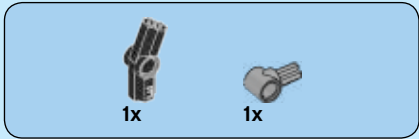
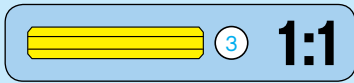

96

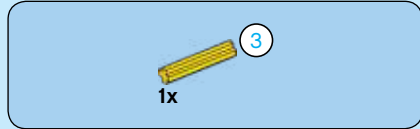
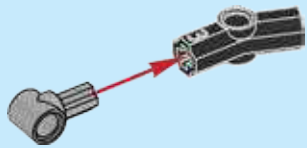

97

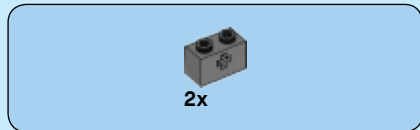
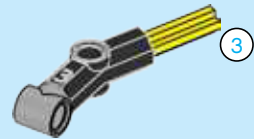

98

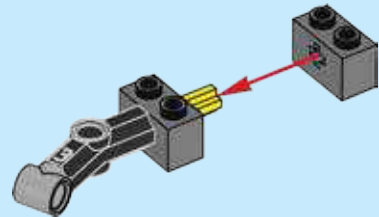



1x

99

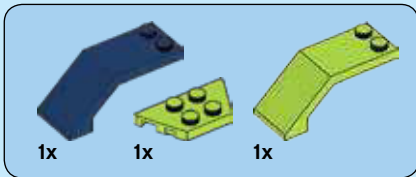

100

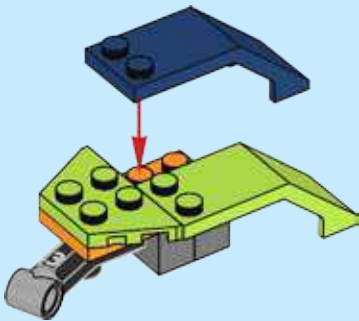

1x

101

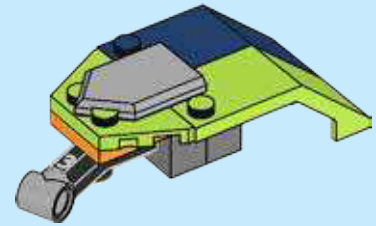

102

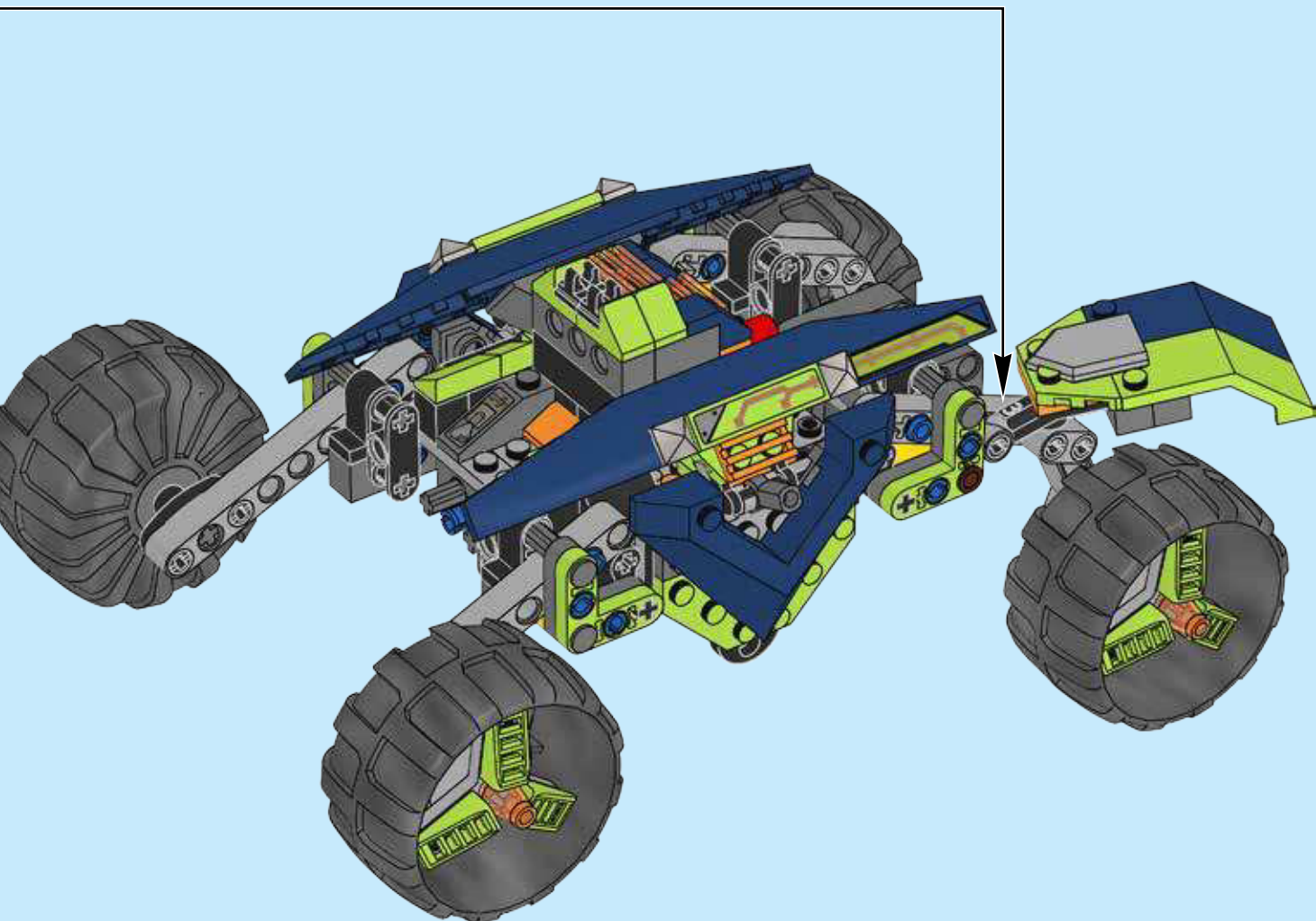



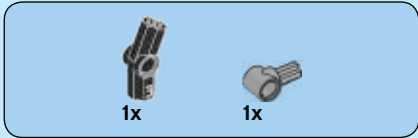
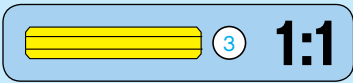

103

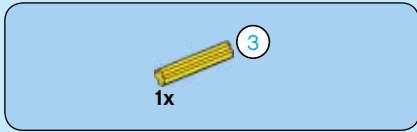
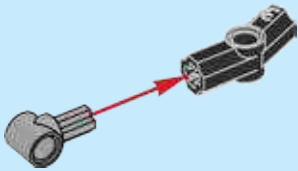

104

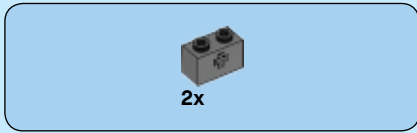
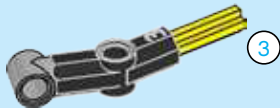

105

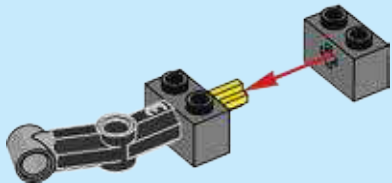



1x

# 106



1x



1x



1x

# 107

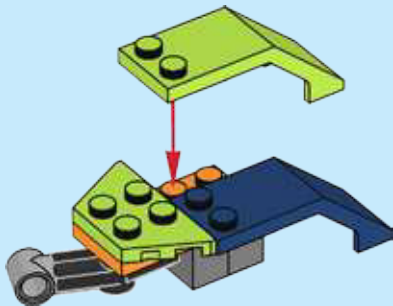

1x

# 108

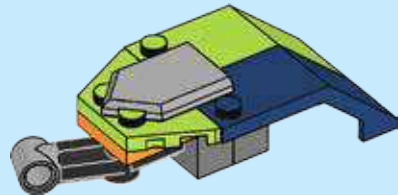

109

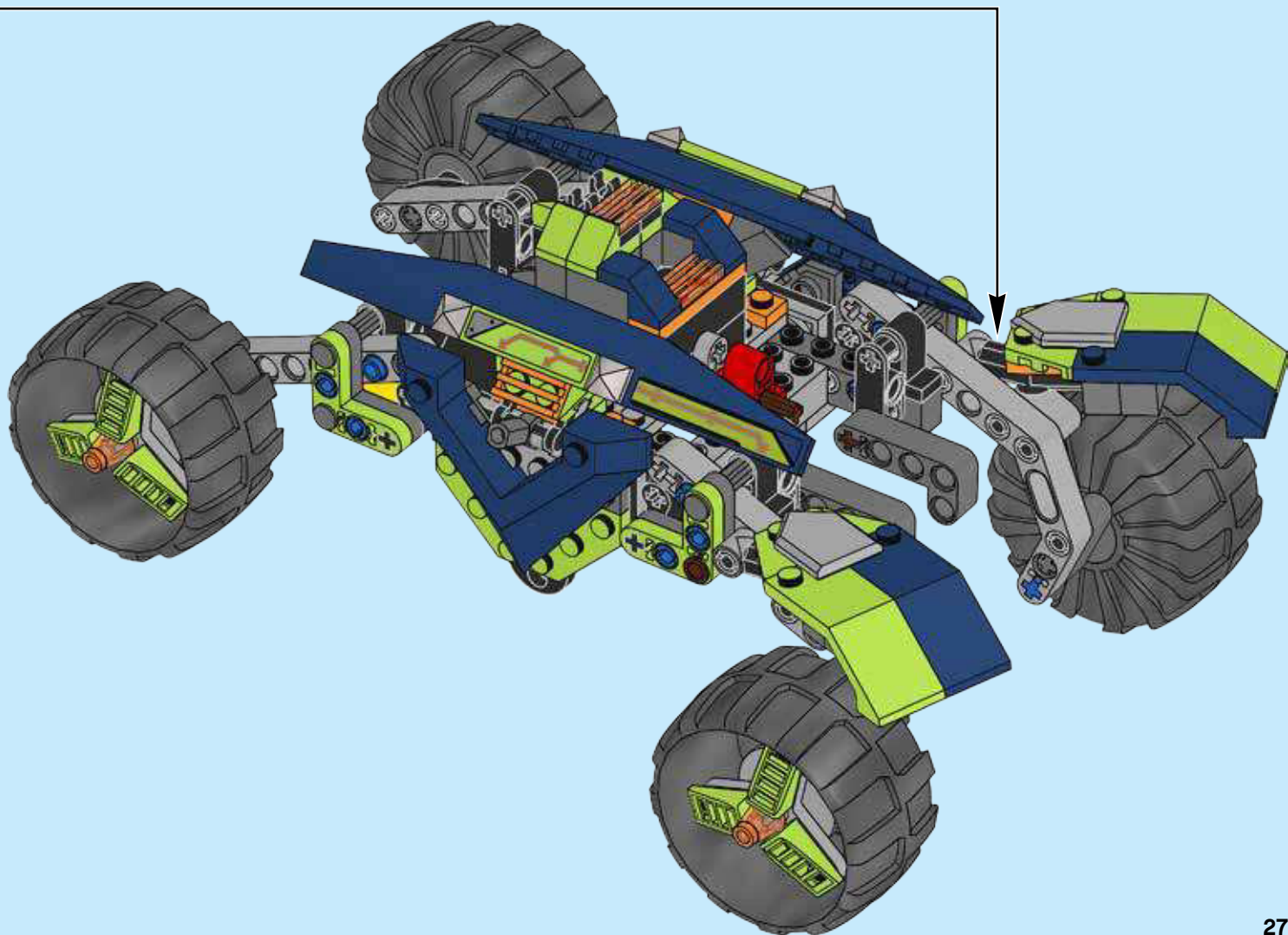

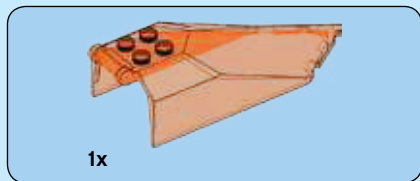

110

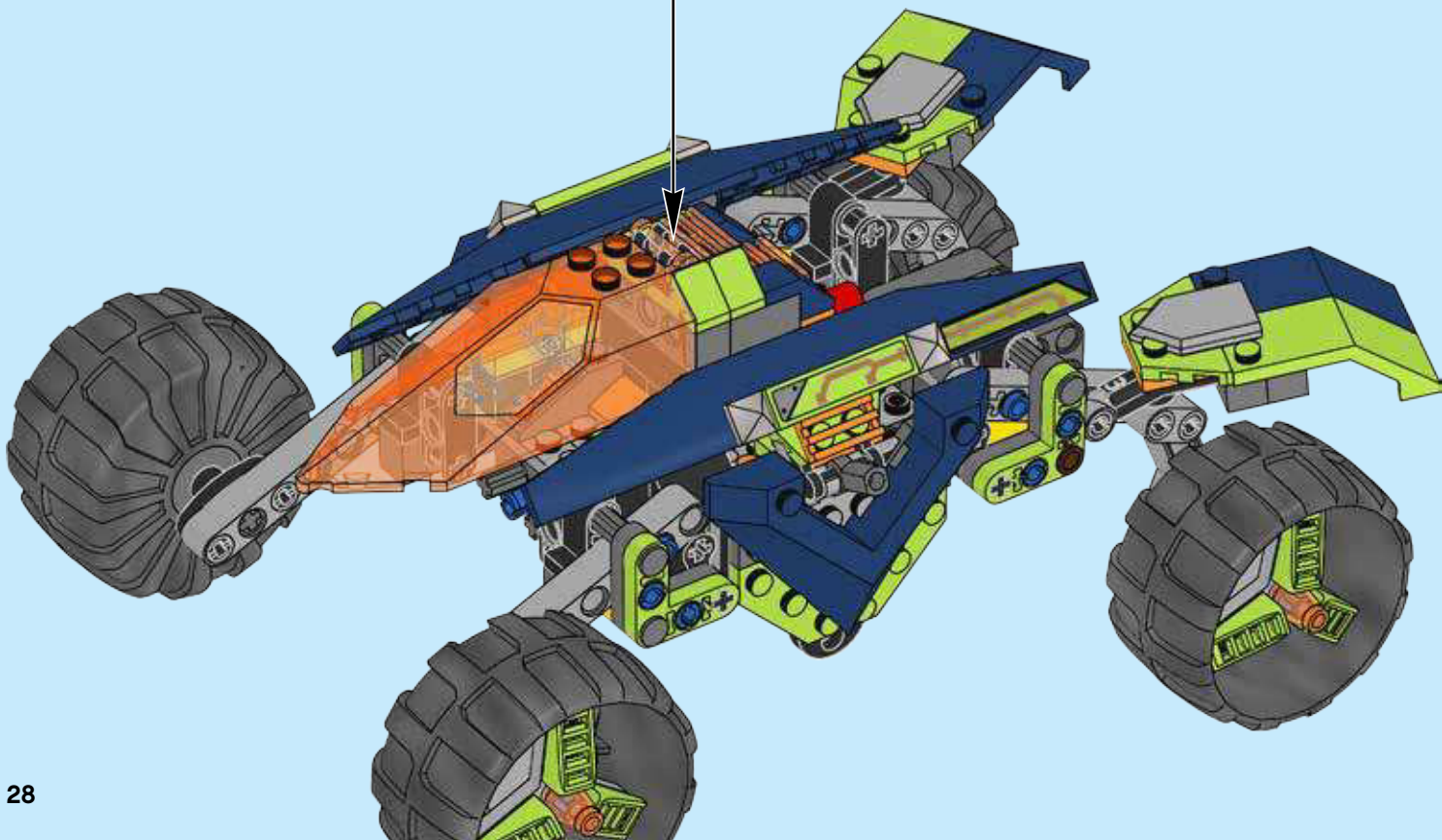
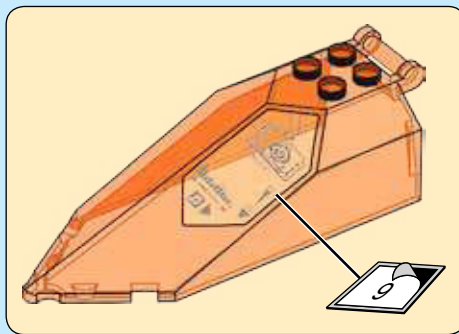

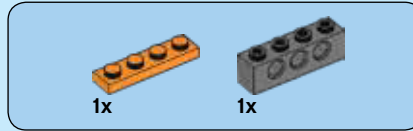
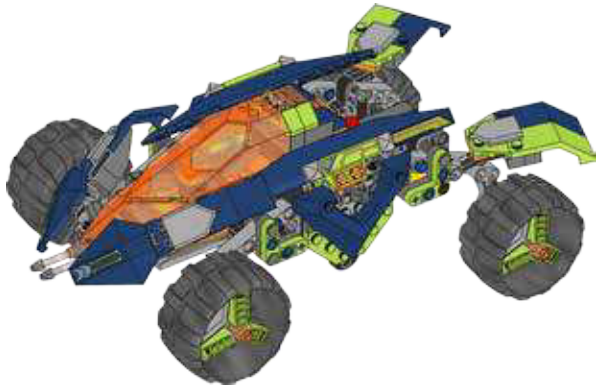
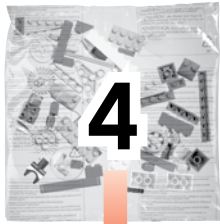

111

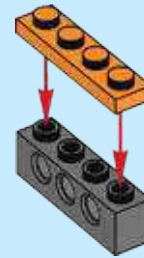

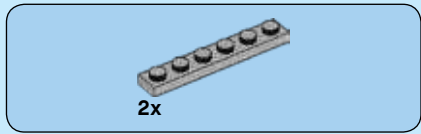

112

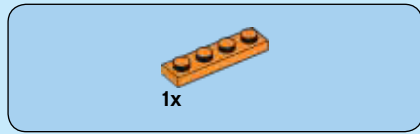
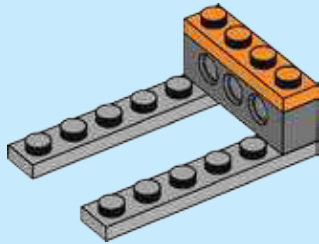

113

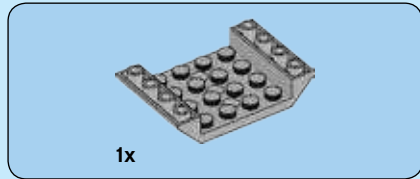
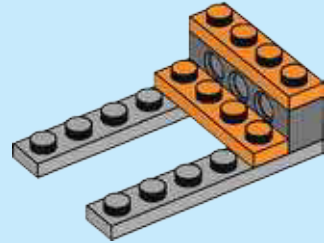

114

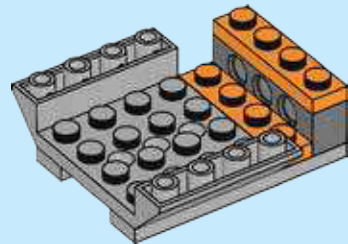



2x

115

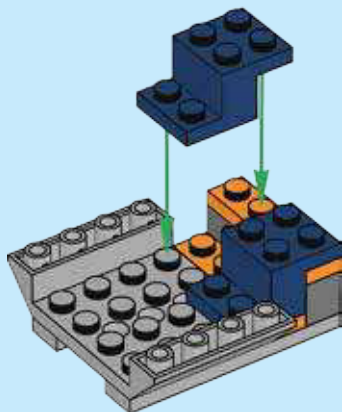

1x



2x

116

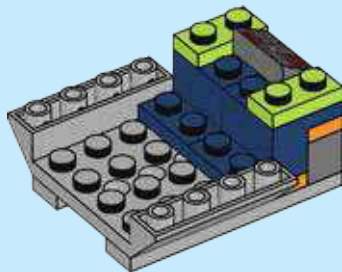

2x

117

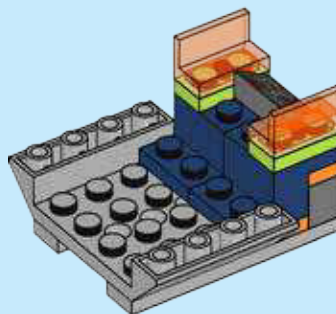





118

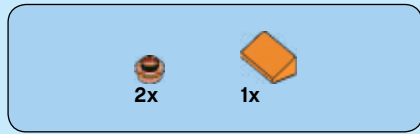
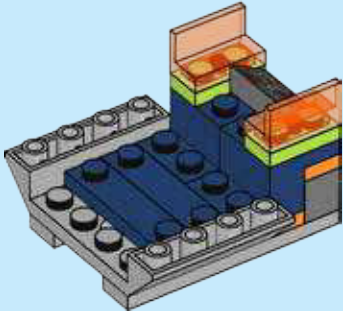

119

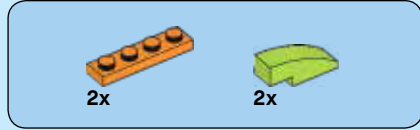
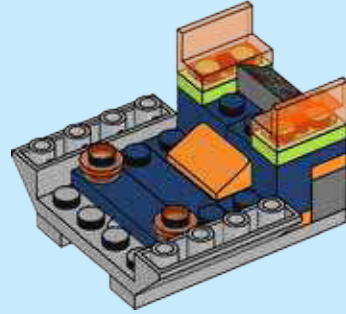

120

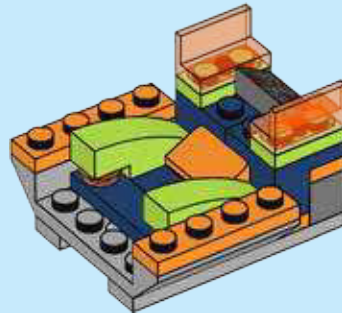





2x

# 121

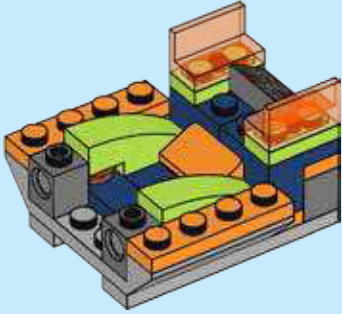

2x



1x

# 122

1

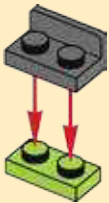

2

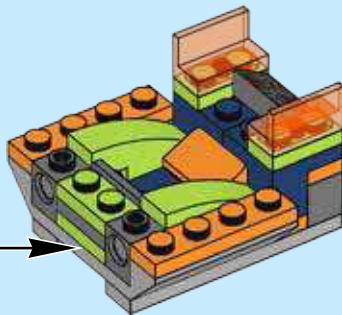

2x

# 123

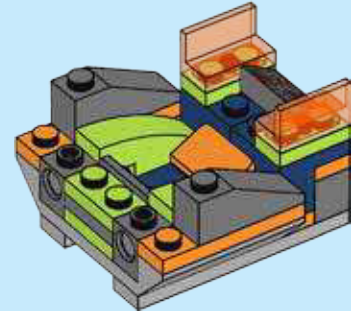

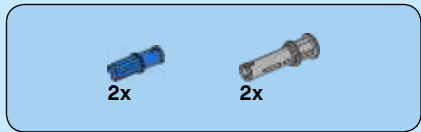

# 124

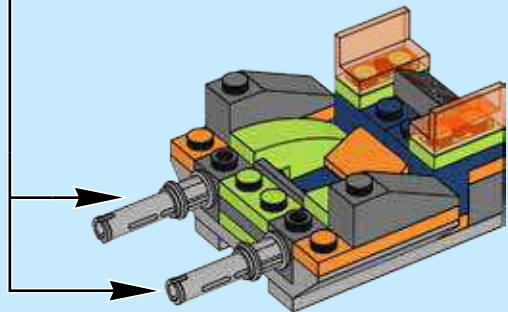
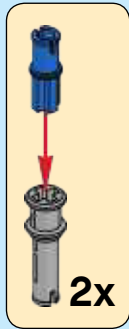

# 125

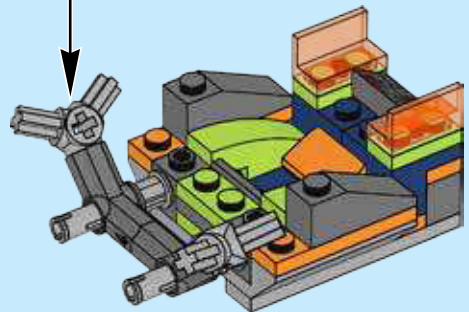
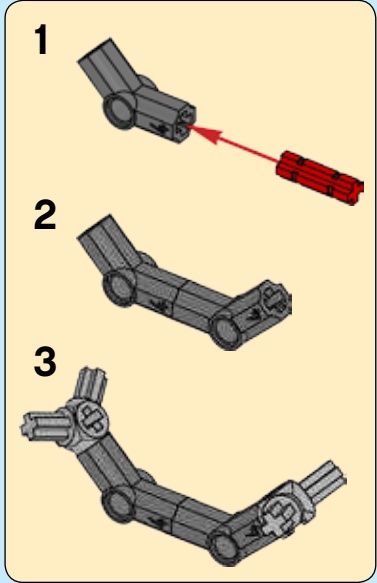

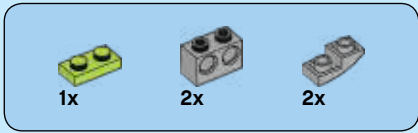

# 126

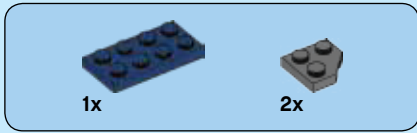
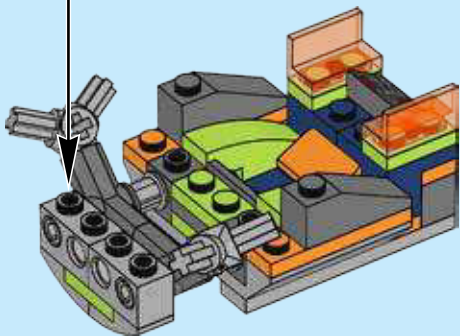
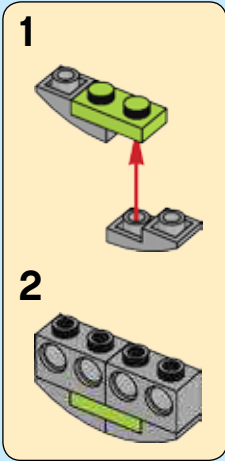

# 127

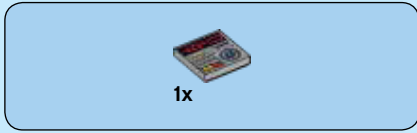
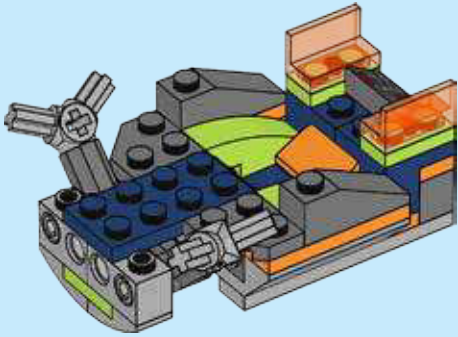

# 128

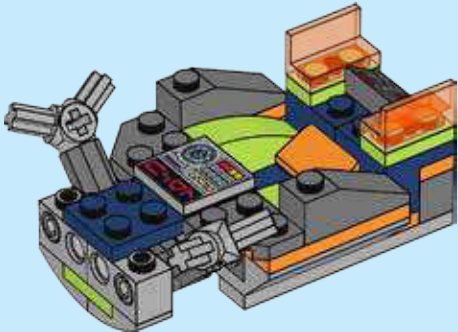



129

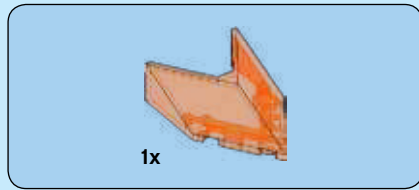
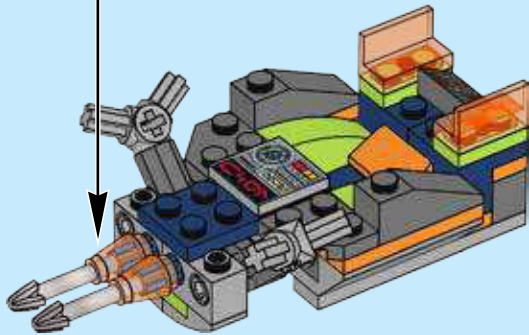
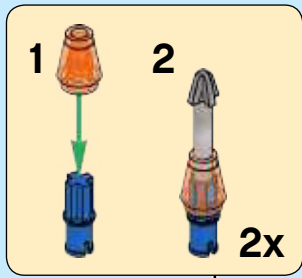

130

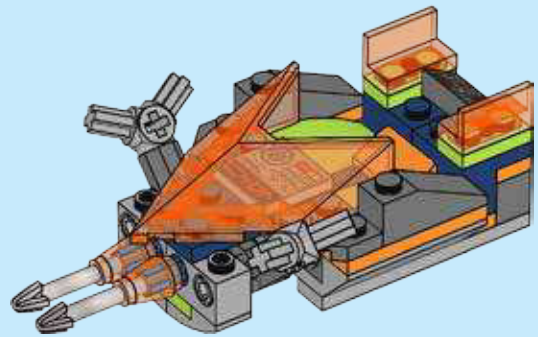



2x

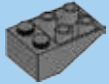

1x



1x

131

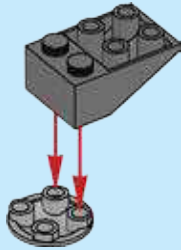

1x

132



2x

133

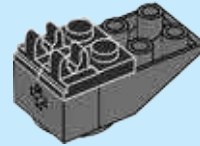

1x



1x

134

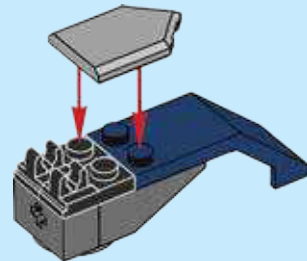

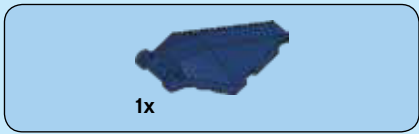

135

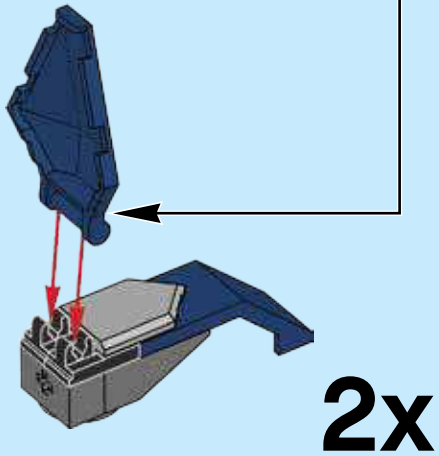
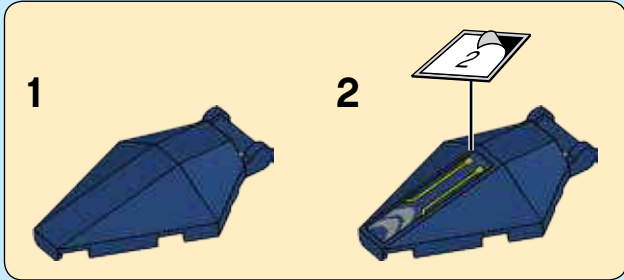

136

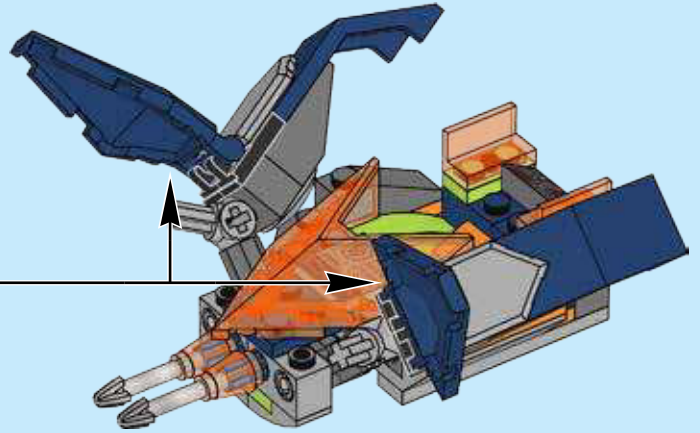

137

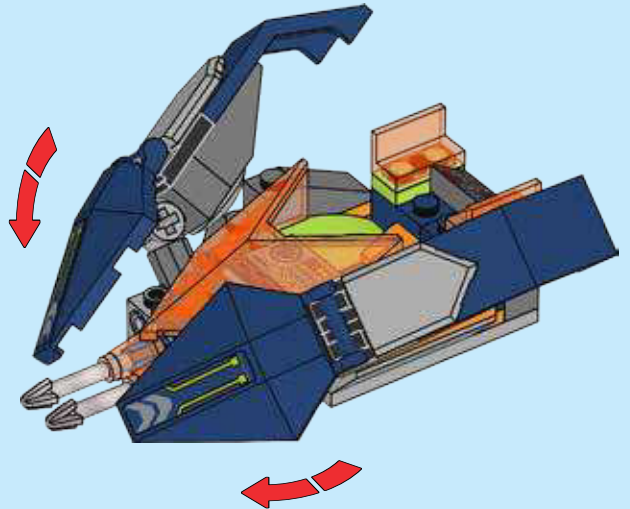

138

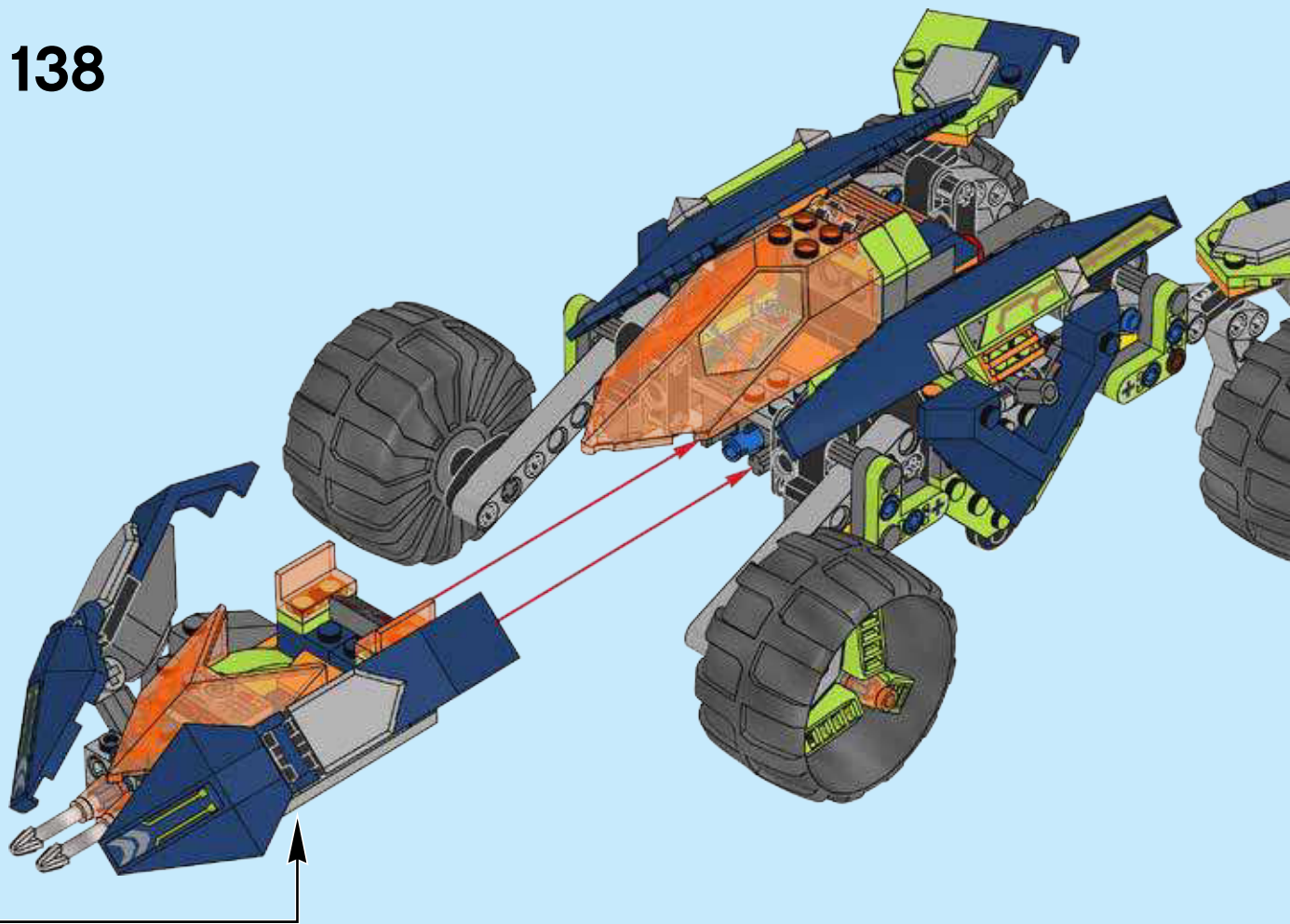



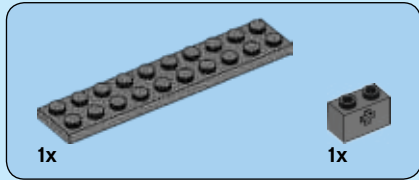

139

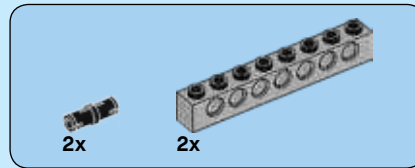
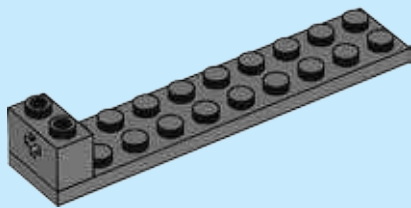

140

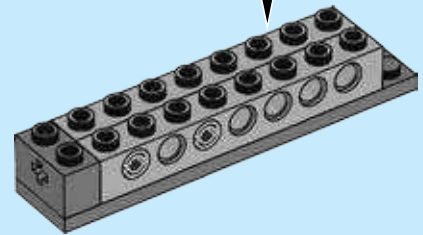
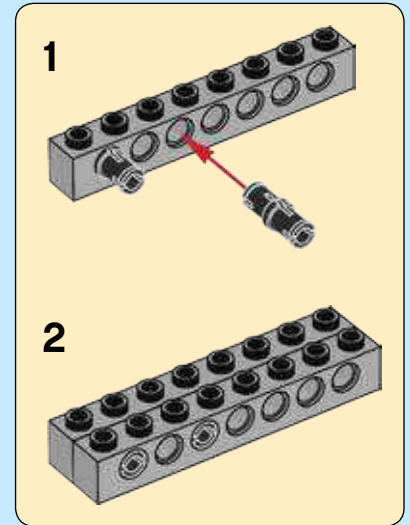





8x

# 141

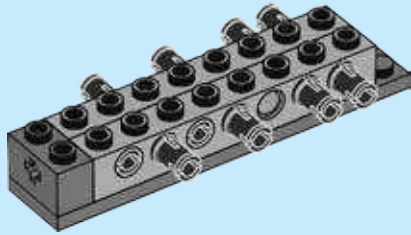

2x



1x

# 142

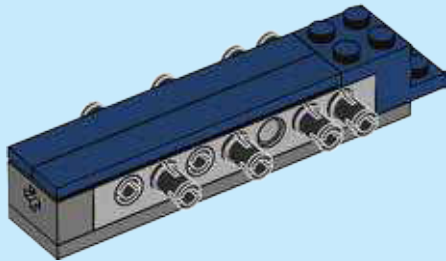

1x

# 143

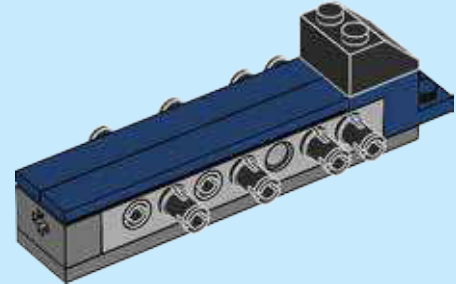
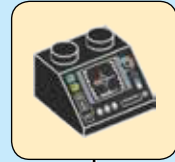

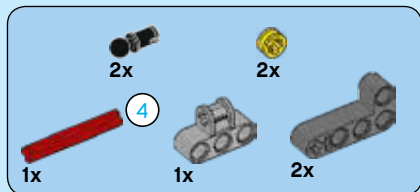

144

1

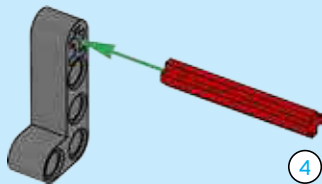

2

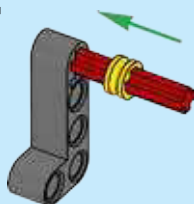

3

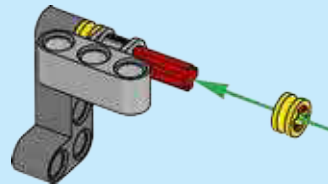

4

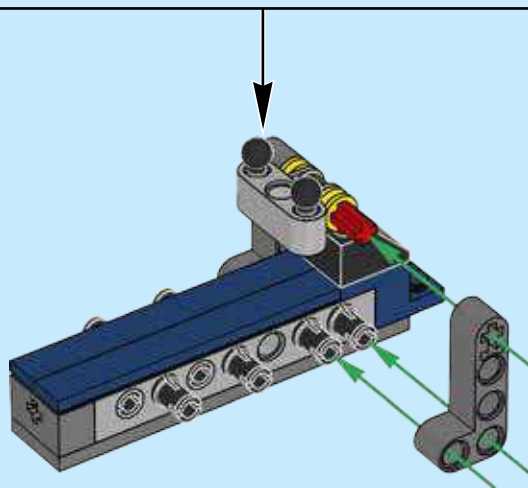
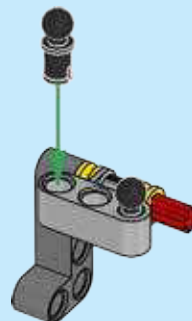

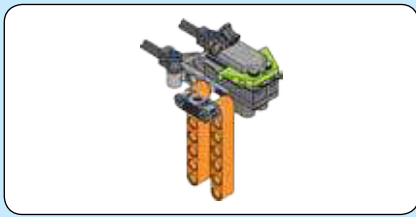

6 1:1

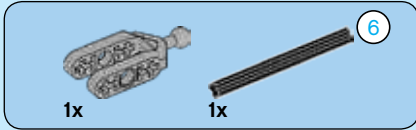

145

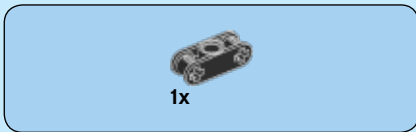
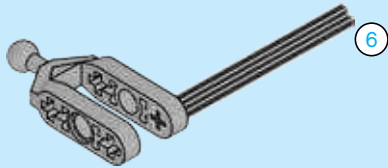

146

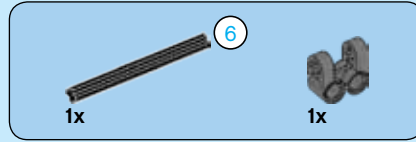
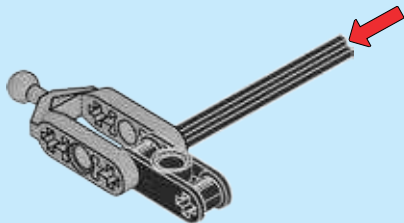

147

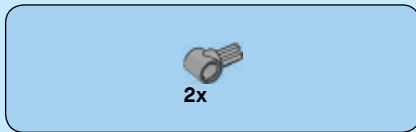
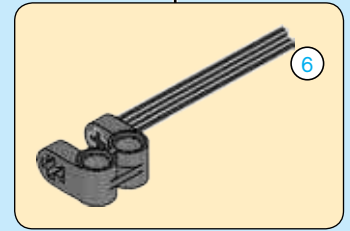
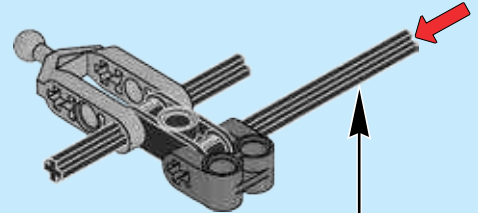

148

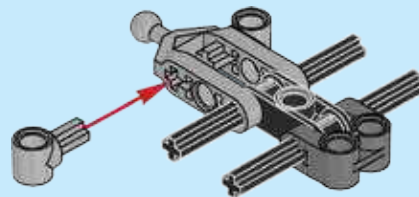



2x



2x

# 149

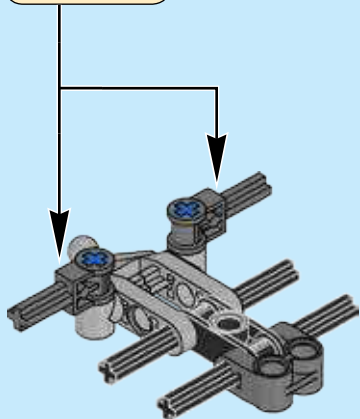
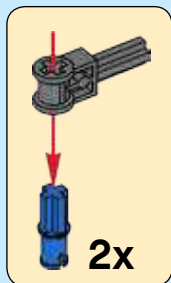

1x



1x

# 150

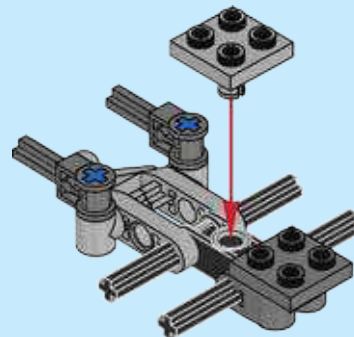

2x



# 151

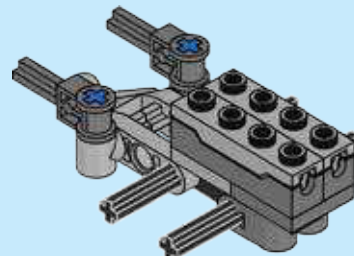



2x



1x

# 152

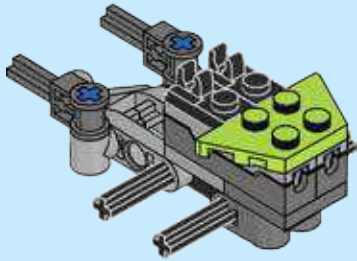

1x

# 153

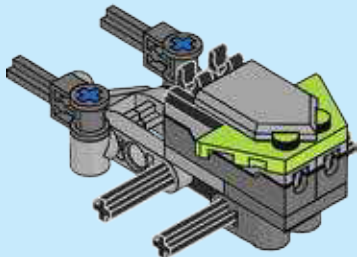

1x

# 154

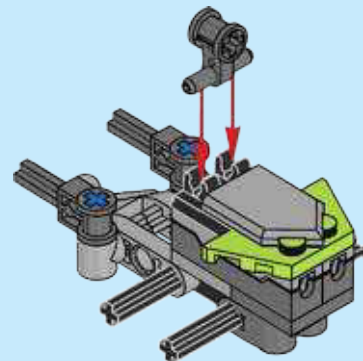

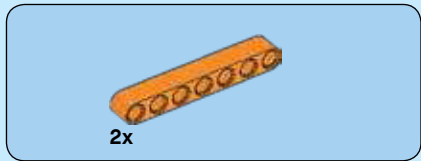

155

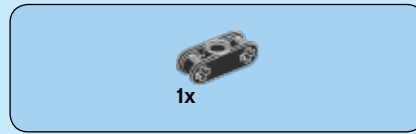
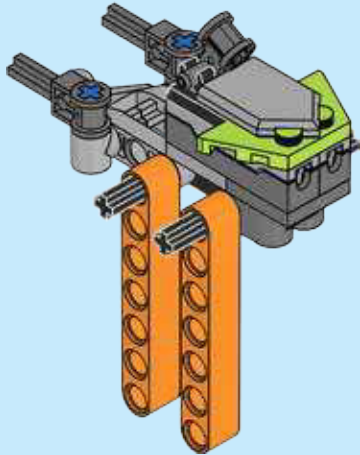

156

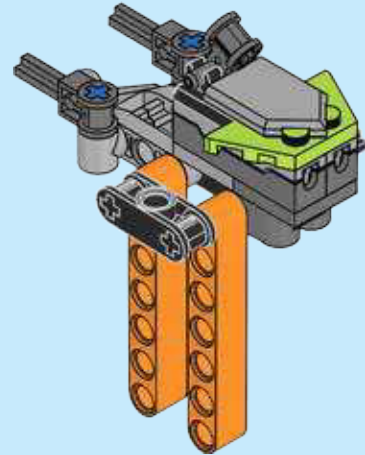

157

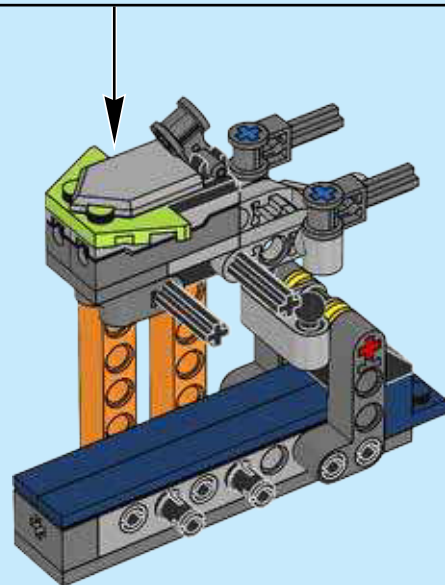

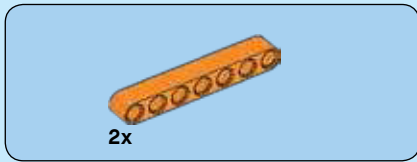

158

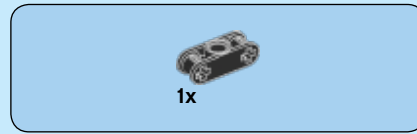
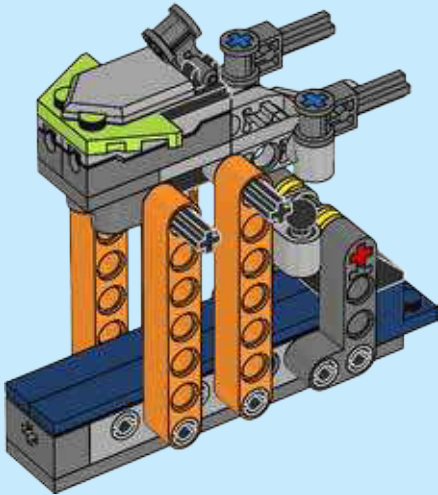

159

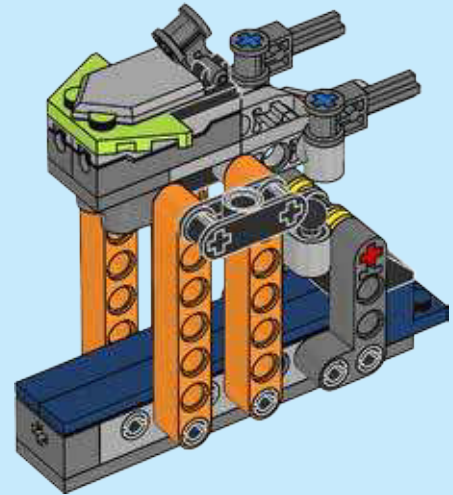

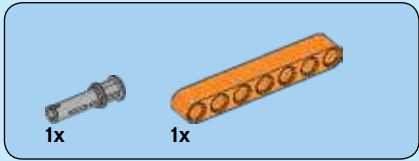
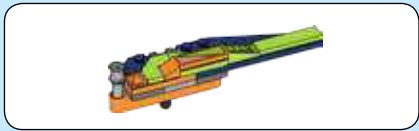

160

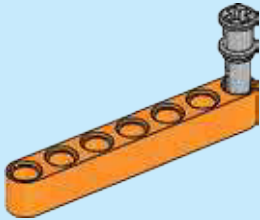

161

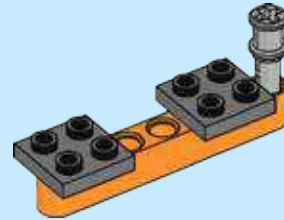

162

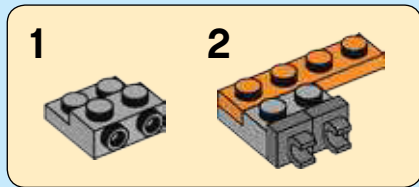

2

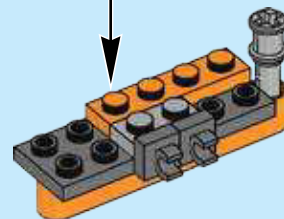
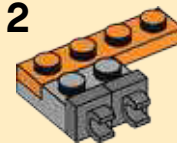





163

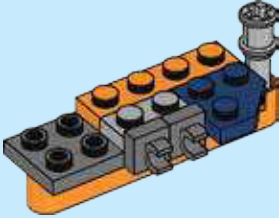

164

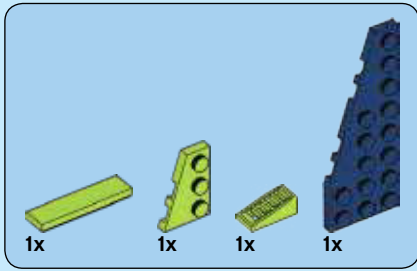
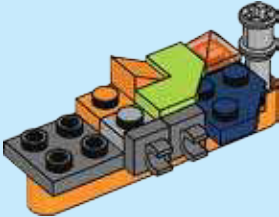

165

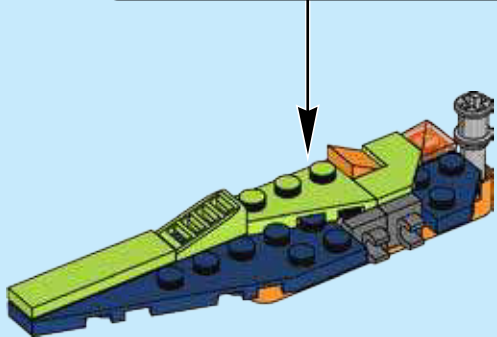
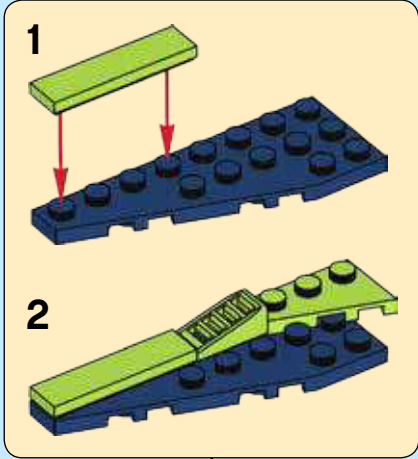



1x

# 166

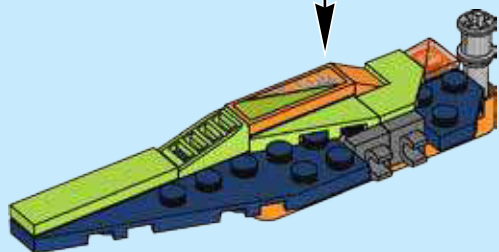
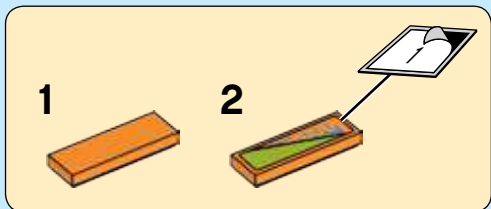

1x

# 167

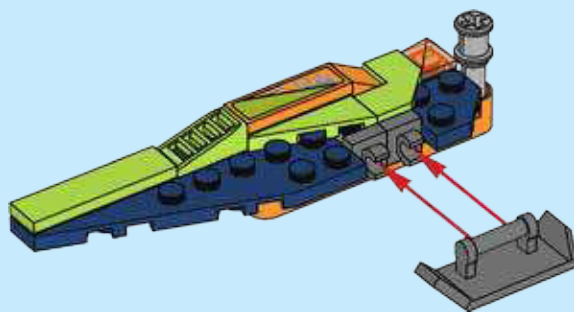



168

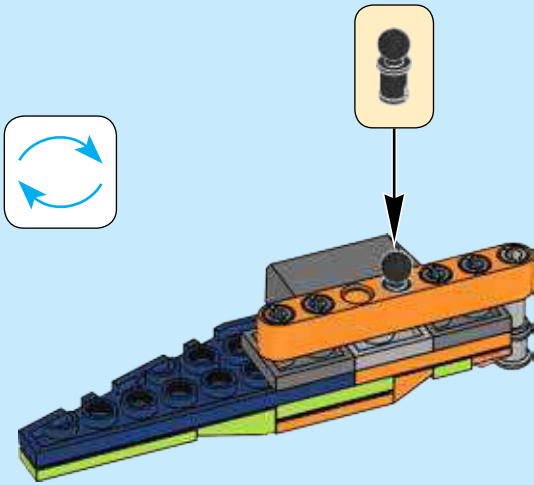

169

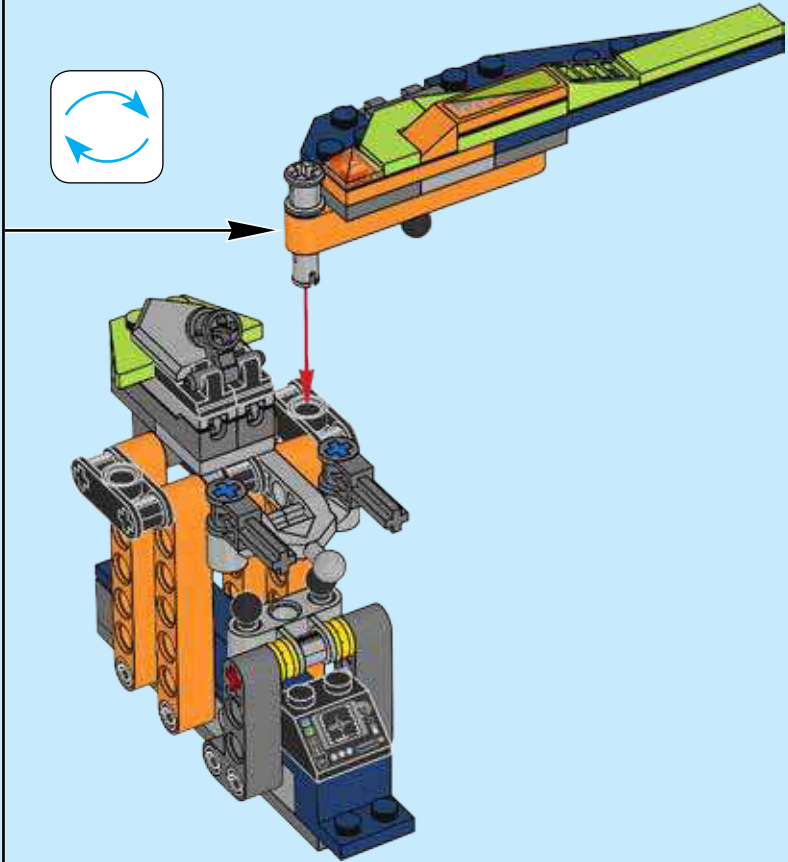

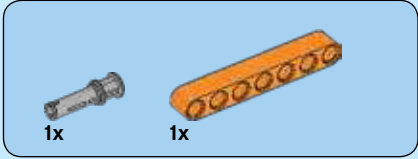

170

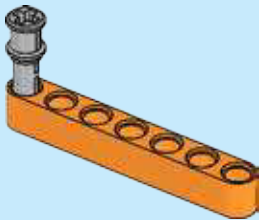

171

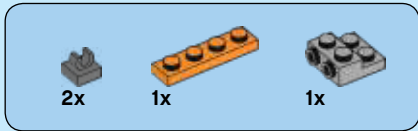
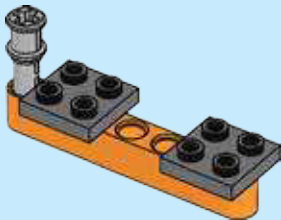

172

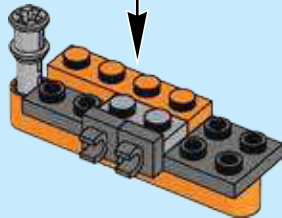
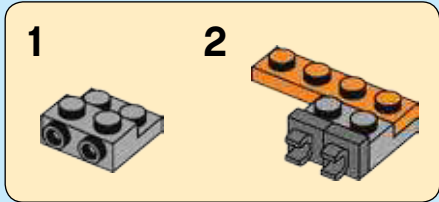



1x

173

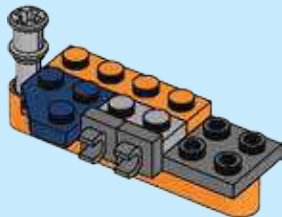

1x



1x



1x

174

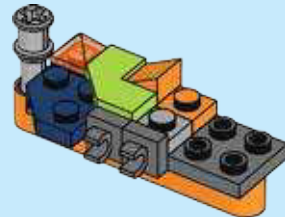

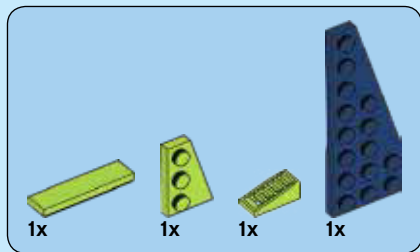

175

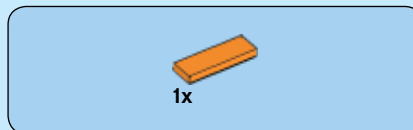
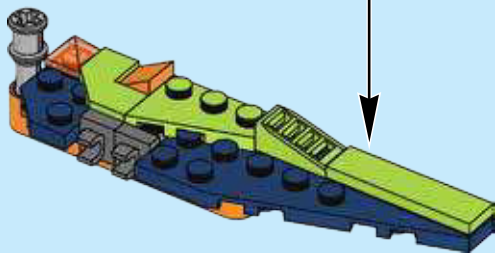
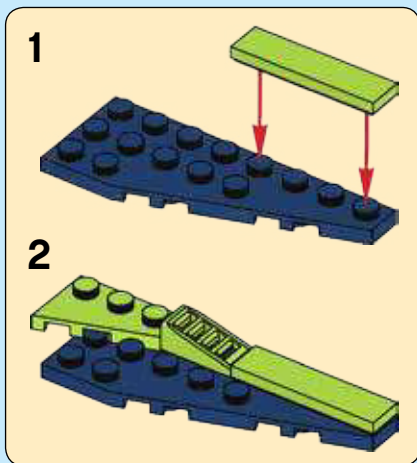

176

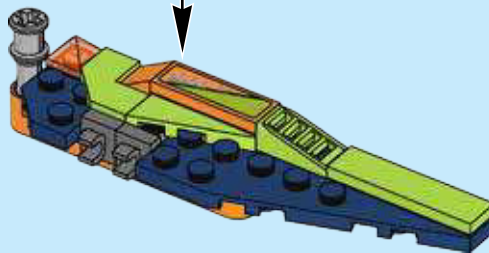



1x

177

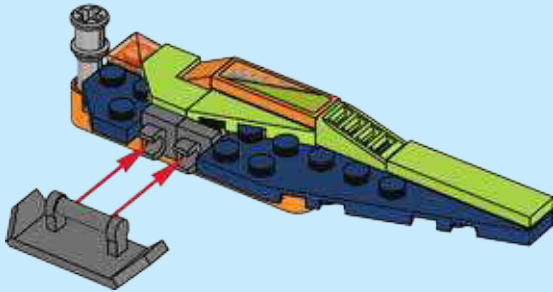

1x

178

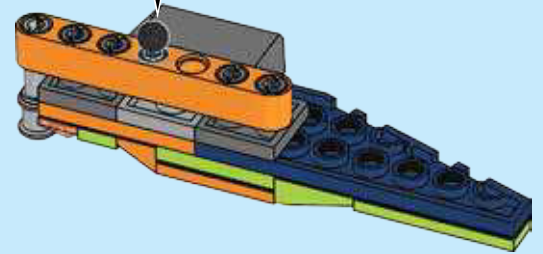
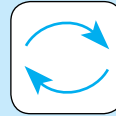

179

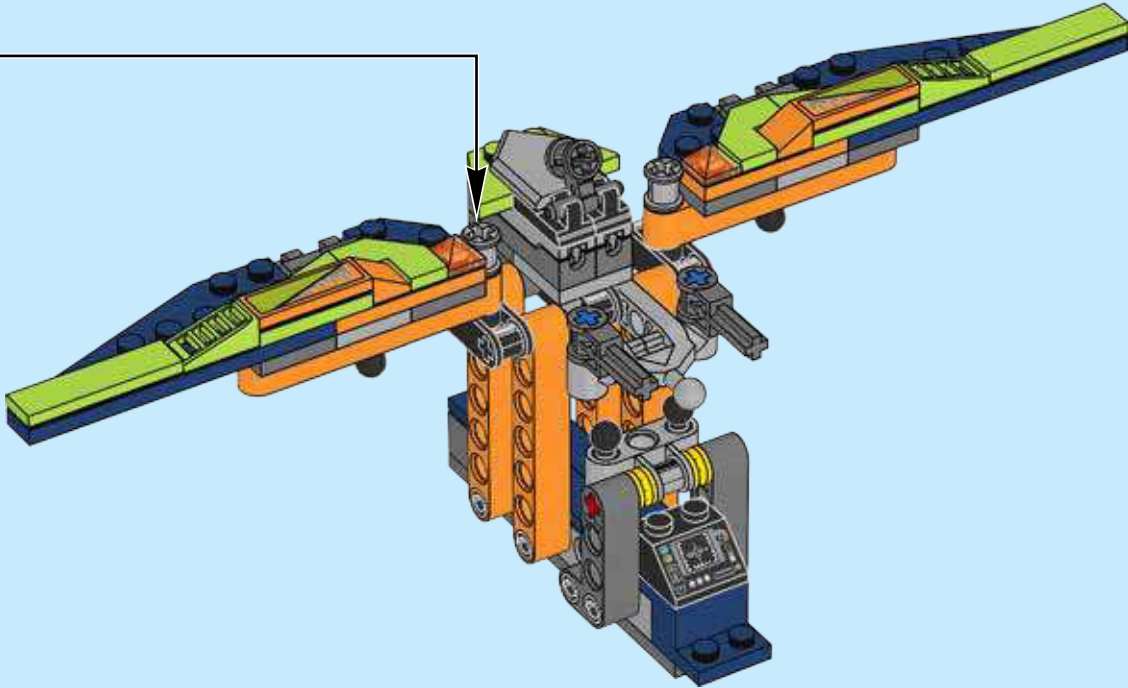



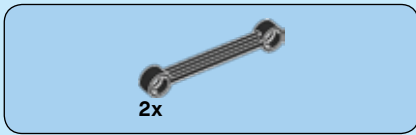

180

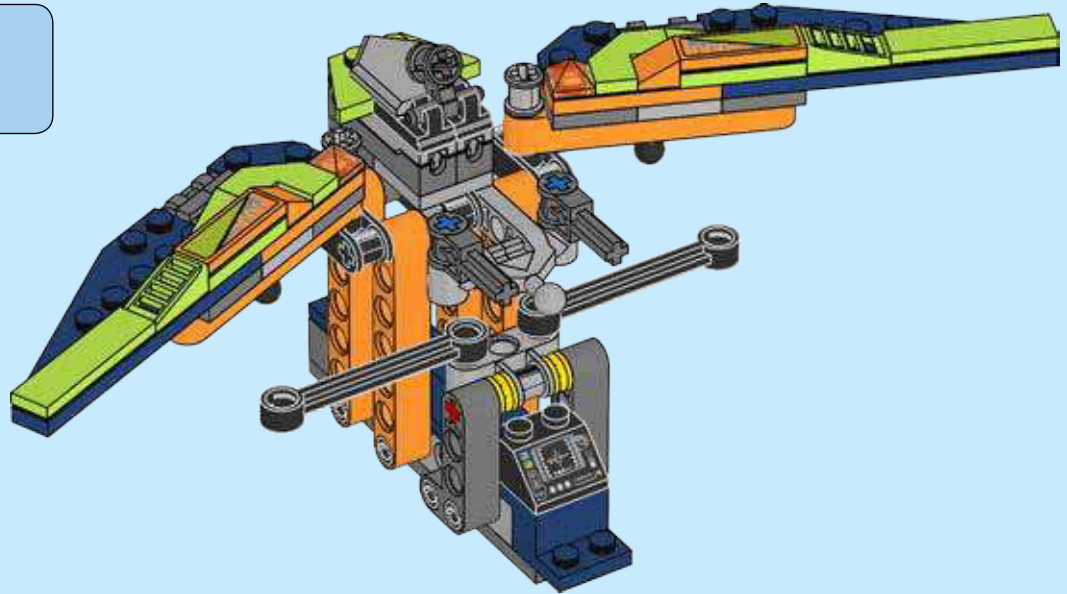

181

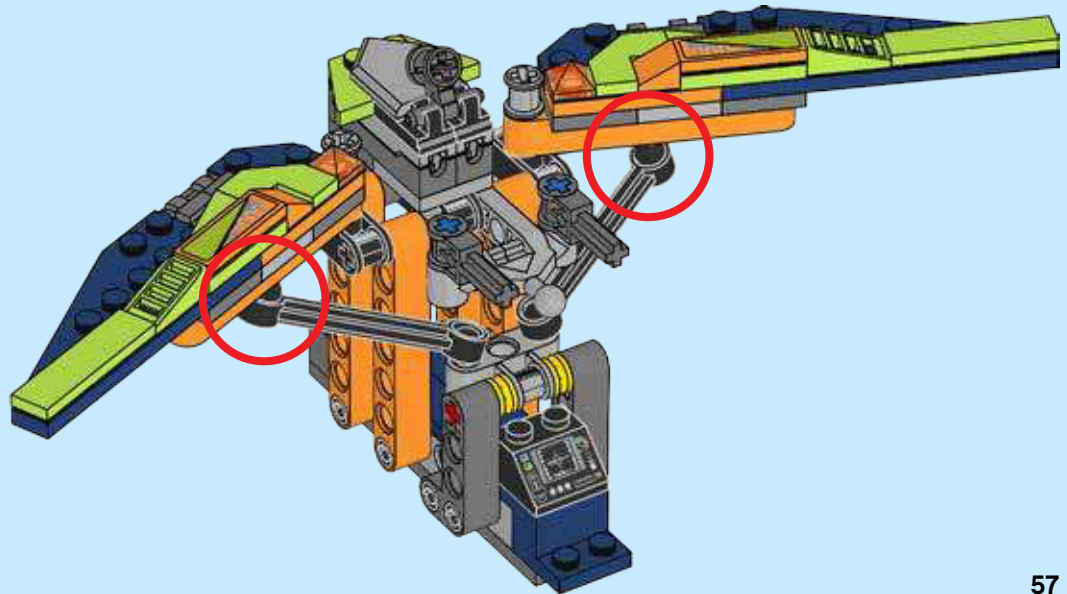

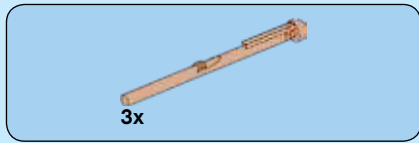

182

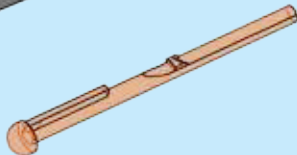
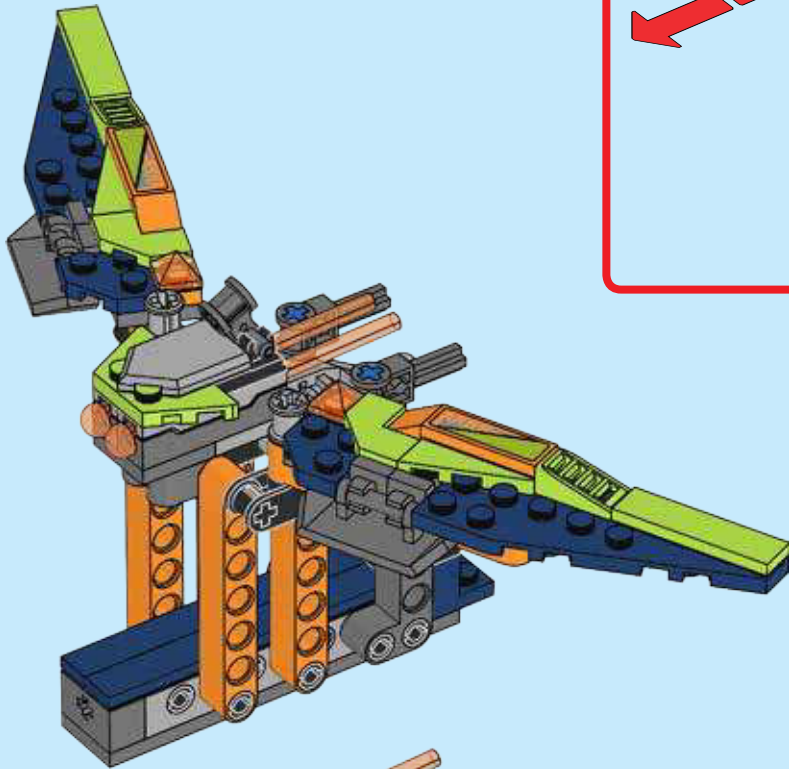
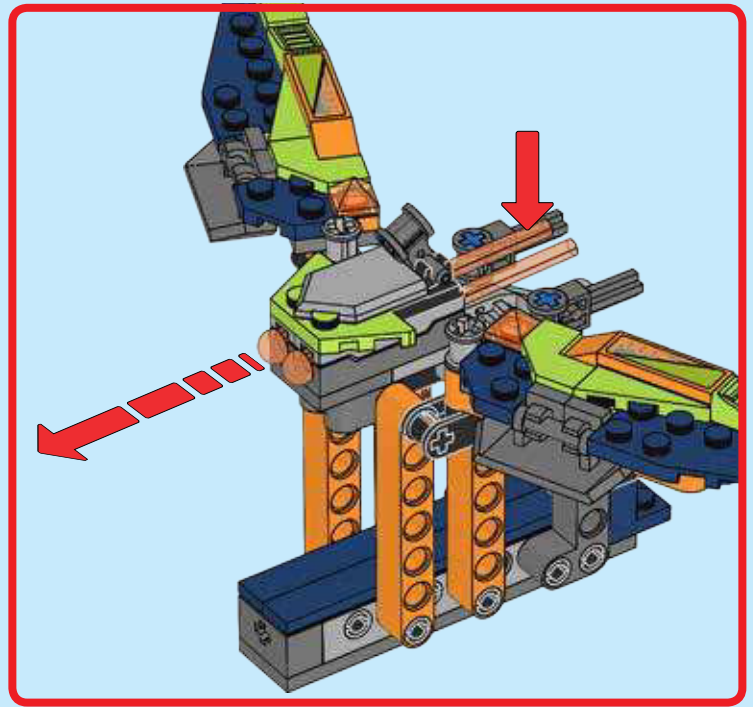

183

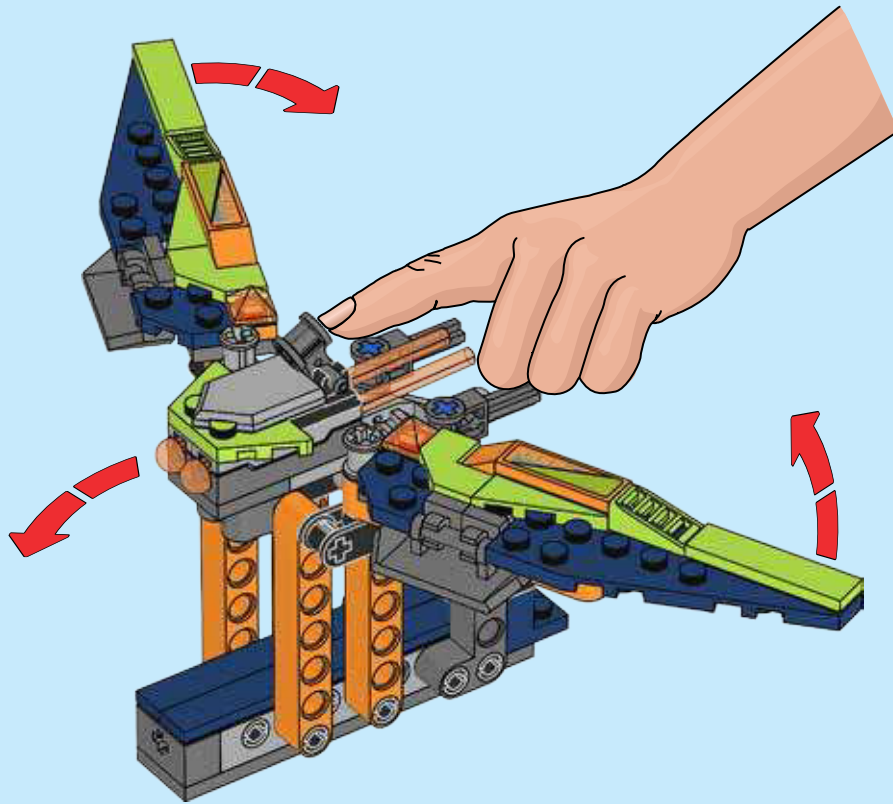

184

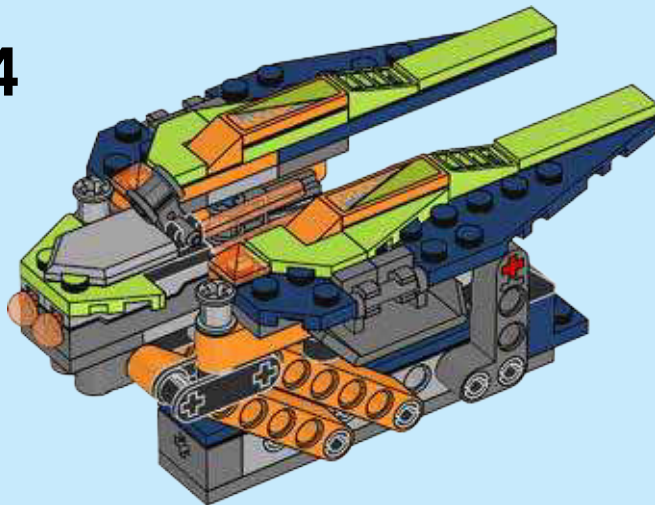

185

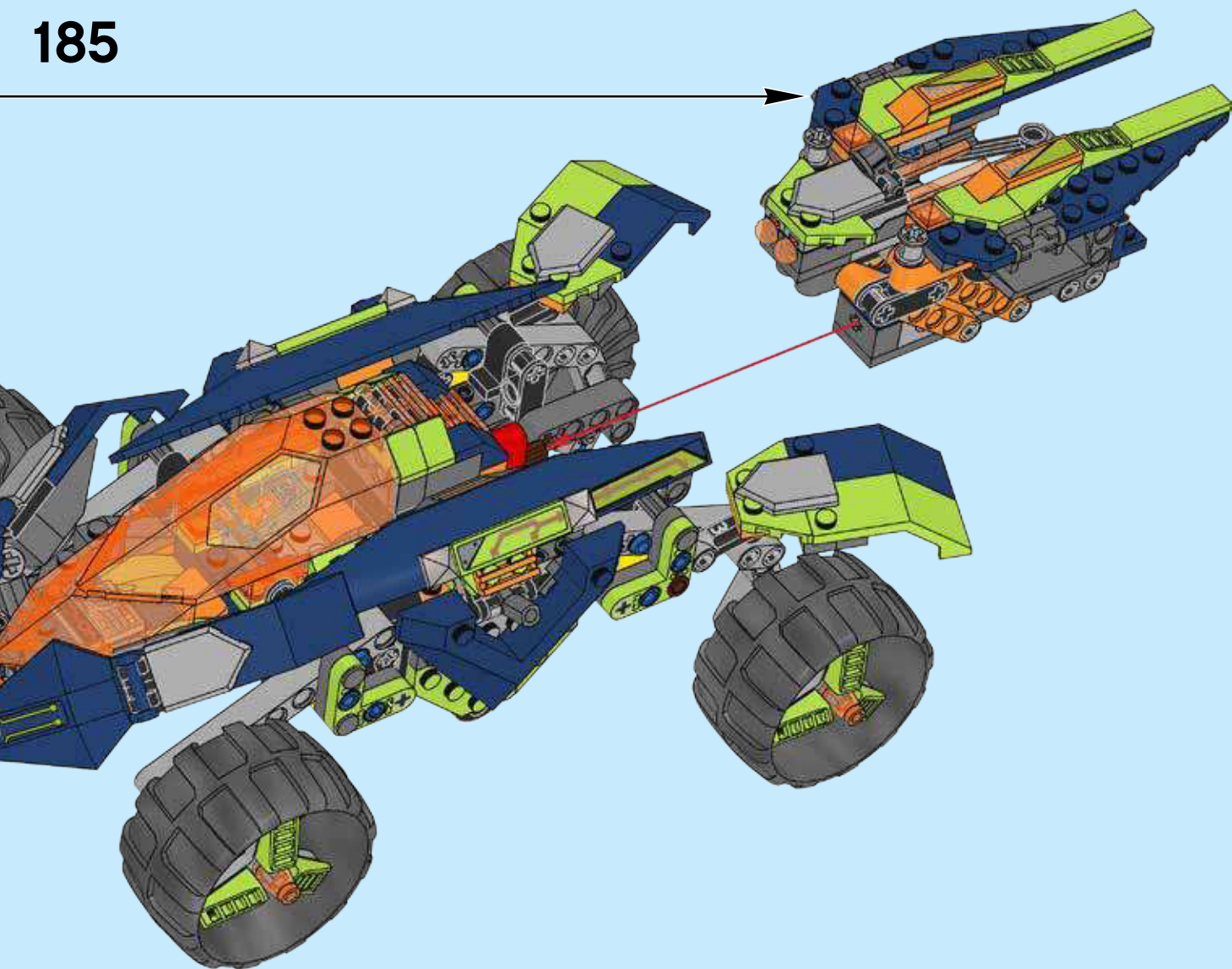



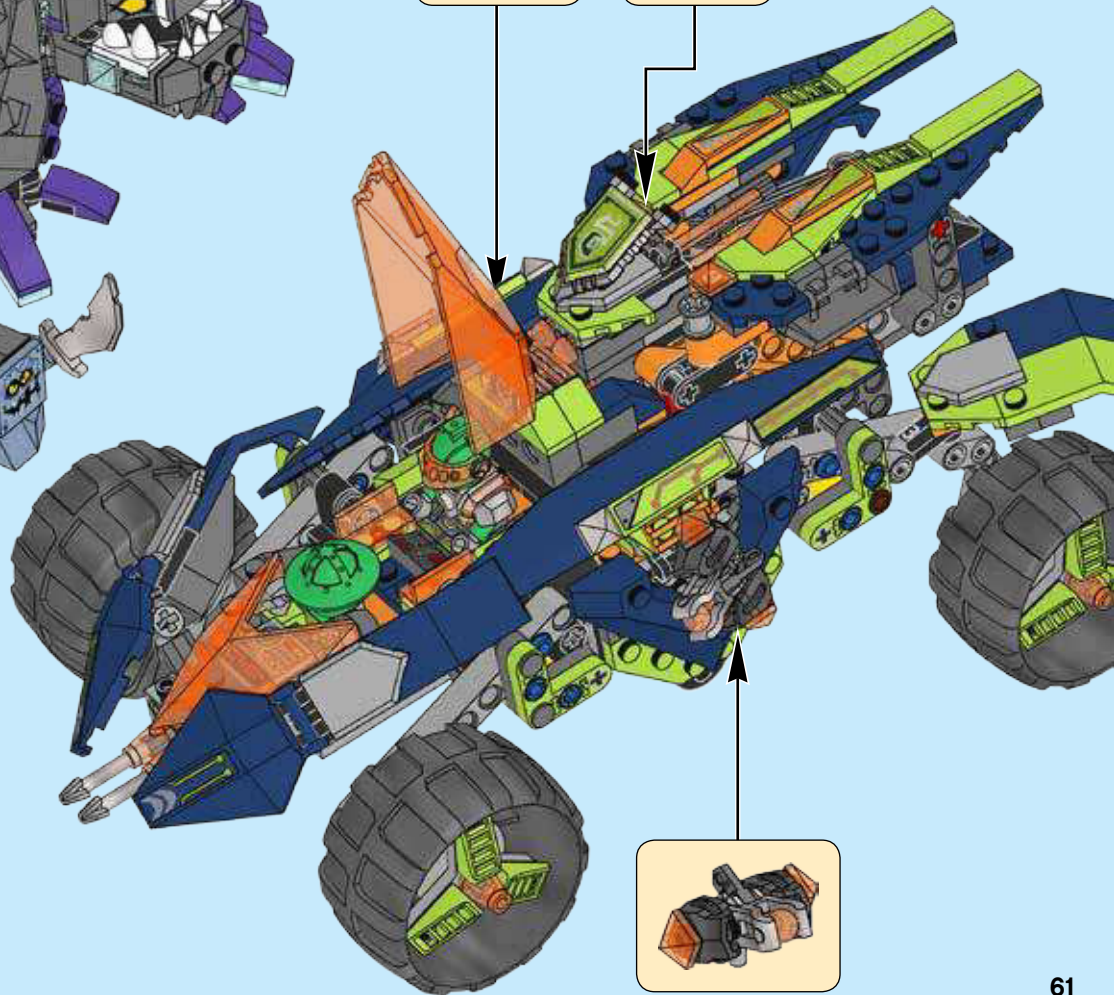
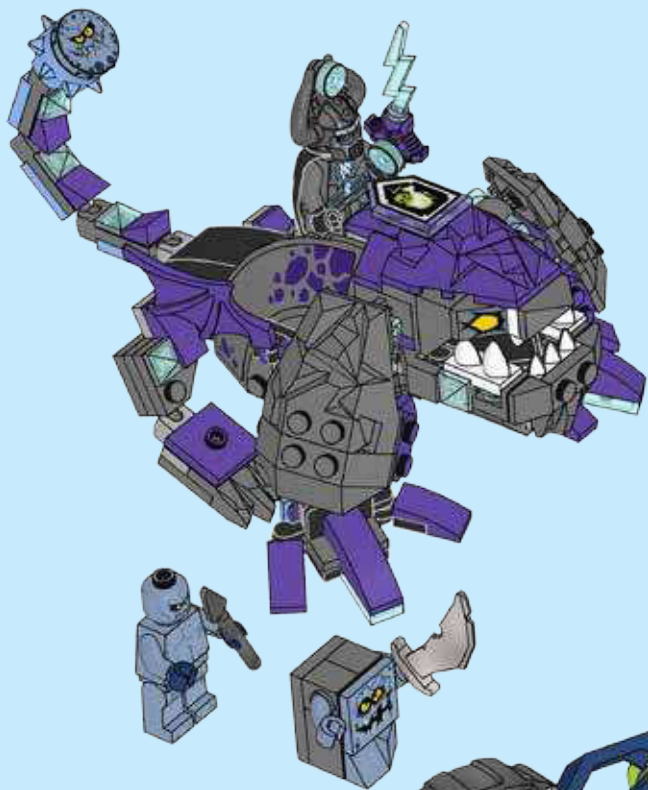

2x  
6046384

1x  
4515337

2x  
6046381

1x  
4186678

1x  
4142865

1x  
4207715

1x  
6129995

4x  
4143005

9x  
4206482

9x  
4514553

2x  
4239601

1x  
6124875

4x  
4187122

2x  
6130007

1x  
6172156

62

1x  
6168590

2x  
4163917

7x  
6164329

4x  
6051918

2x  
6194923

2x  
6045980

2x  
300526

2x  
4107082

6x  
4184169

4x  
4550017

22x  
4121715

1x  
4185620

4x  
4198367

10x  
4598528

4x  
4144024

6x  
6000650

2x  
6055630

2x  
4225201

1x  
366026

1x  
6083346

2x  
303926

4x  
6089119

2x  
6052126

7x  
4121667

1x  
6128992

2x  
317626

2x  
6118829

1x  
6188303

2x  
6099483

2x  
302126

4x  
300126

2x  
370626

2x  
4629921

2x  
379526

1x  
4180548

6x  
6124858

2x  
3005747

4x  
6127035

2x  
6131711

2x  
6127431

2x  
6124829

1x  
6161315

1x  
6129592

3x  
6124908

1x  
6166861

2x  
6164313

3x  
4179825

1x  
6176828

1x  
4201235

2x  
4504371

2x  
6068996

2x  
4125254

2x  
4159007

2x  
4620693

9x  
4118782

2x  
4158355

6x  
6102621

1x  
4654448

1x  
6125468

1x  
6127159

4x  
403228

1x  
6170553

1x  
6172780

1x  
6176776

2x  
6062686

1x  
6174488

2x  
6177934

1x  
6176823

1x  
6176786

1x  
6176898

2x  
6164071

2x  
6166857

1x  
4651373

1x  
4651377

3x  
6132157

2x  
6036240

1x  
4667595

4

6

3



4x  
6130061



2x  
6166852



2x  
4507080



2x  
6131732

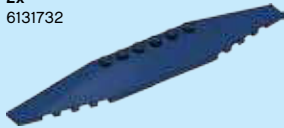

2x  
6128687



1x  
6135494



2x  
6159763



1x  
6164527



1x  
6164649



2x  
4542590



1x  
6129994



3x  
4211375



2x  
4278273



4x  
6123815



2x  
4211862



2x  
6144138



2x  
6206249



7x  
6043656



2x  
4211541



5x  
4654582



2x  
4556157



4x  
4667578



2x  
4502595



1x  
4211566



1x  
4615837



7x  
4237084



2x  
4654577



4x  
4211865



1x  
4538007



5x  
6138695



2x  
4211396



2x  
4211438



1x  
4211425



2x  
4211442



1x  
4549997



1x  
4549997



3x  
4211406



2x  
6102449



2x  
4234240



2x  
6048898



4x  
4262978



1x  
4211711



1x  
6012653



1x  
4211408



1x  
4211848



2x  
4504372



1x  
4539908



1x  
4539907



2x  
6025026



14x  
4540385



7x  
4164037



4x  
6170559



4x  
6133508



2x  
6166895



2x  
4537928



2x  
6185123



5x  
6025027



4x  
4164021



2x  
6185121



2x  
6015890



2x  
6175554



1x  
6182430



1x  
6051334



2x  
4504378



4x  
6071226



4x  
4210639



1x  
6020189



2x  
4210688



4x  
6055313



1x  
6076203



1x  
6152814



1x  
6182209



1x  
6182216



1x  
4234599



2x  
6092572



2x  
6168776



7x  
6178919



10x  
6164073



2x  
6192870



2x  
6117972



7x  
6000606



3x  
6168609



4x  
4210659



2x  
6123814



4x  
4211094



5x  
6066952



2x  
4211109



1x  
4211060



2x  
6015356



2x  
4210665



2x  
4210751



4x  
4211045



3x  
6039482



2x  
6027686



2x  
4582257



1x  
4211043



3x  
4211064



6x  
6083620



2x  
4497253

4



4x  
4210667



2x  
6124820



3x  
4213607



1x  
4211127



3x  
4211076



4x  
4508553



2x  
6055063



2x  
4210917



2x  
4622338



1x  
4210678



2x  
4211137



2x  
4211137



2x  
4211137



2x  
4211137

5.5



2x  
6162578



1x  
6125244



4x  
6127036



1x  
6129534



1x  
6131790



1x  
4615594



1x  
6170534



1x  
4611882



3x  
4567509



1x  
6185153



2x  
6134312



8x  
6057390



4x  
4655695



2x  
6126086



7x  
6109766



2x  
6103449



2x  
6133818



1x  
6030277



1x  
6169917



1x  
6190282



2x  
6125856



2x  
6168708



1x  
6182250



1x  
4614336



1x  
4614336



1x  
4614336



1x  
4614336



1x  
4614336



**Customer Service**  
Kundenservice  
Service Consommateurs  
Servicio Al Consumidor  
[LEGO.com/service](http://LEGO.com/service) or dial

00800 5346 5555 :   
1-800-422-5346 : 



# COMBINE YOUR POWERS



70364

1

70355

2



70355 + 70364

3



COMBINE YOUR POWERS . KOMBINIERE DEINE KRÄFTE . COMBINE TES POUVOIRS . COMBINA I TUOI POTERI  
COMBINA TUS PODERES . COMBINA OS TEUS PODERES . KOMBINÁLD ERŐIDET! . 组合你的力量



# NEXO KNIGHTS™

## DISCOVER MORE COMBINATIONS



70362



70363



70364



70365



70366



70349



70351



70354



70355



70361



[LEGO.COM/NEXOKNIGHTS](http://LEGO.COM/NEXOKNIGHTS)

DISCOVER MORE COMBINATIONS / WEITERE KOMBINATIONEN ENTDECKEN / DÉCOUVRE PLUS DE COMBINAISONS / SCOPRI ALTRE COMBINAZIONI /  
DESCUBRE MÁS COMBINACIONES / DESCUBRE MAIS COMBINAÇÕES / FEDEZZ FEL MÉG TÖBB KOMBINÁCIÓ! / 发现更多组合





# NEXO KNIGHTS



LEGO® NEXO KNIGHTS™: MERLOK 2.0



LEGO



1



2



3

[LEGO.COM/DEVICECHECK](http://LEGO.COM/DEVICECHECK)



# NEXO KNIGHTS



COMBINE YOUR  
POWERS



70362



70363



70364



70365



70366



70373



COMBINE YOUR POWERS • KOMBINIERE DEINE KRÄFTE • COMBINE TES POUVOIRS • COMBINA I TUOI POTERI  
• COMBINA TUS PODERES • COMBINA OS TEUS PODERES • KOMBINÁLD ERŐIDET! • 组合你的力量



# LEGO NEXO KNIGHTS



DOWNLOAD THE FREE APP;/KOSTENLOSE APP HERUNTERLADEN;/TÉLÉCHARGE L'APPLI GRATUITE ;  
SCARICA L'APP GRATUITA;/DESCARGA LA APP GRATIS;/DESCARGA LA APP GRATIS;  
TÖLTSD LE AZ INGYENES APPOT!/下载免费 APP:

LEGO® NEXO KNIGHTS™: MERLOK 2.0 [LEGO.com/devicecheck](http://LEGO.com/devicecheck)

ALL MATERIALS MIGHT NOT BE AVAILABLE IN ALL MARKETS.  
MÖGLICHERWEISE IST NICHT DAS GANZE MATERIAL IN ALLEN MÄRKTEN VERFÜGBAR.  
CERTAINS PRODUITS PEUVENT NE PAS ÊTRE DISPONIBLES SUR CERTAINS MARCHÉS.  
TUTTI I MATERIALI POTREBBERO NON ESSERE DISPONIBILI IN TUTTI I MERCATI.  
CIERTOS MATERIALES PODRÍAN NO ESTAR DISPONIBLES EN TODOS LOS MERCADOS.  
OS MATERIAIS PODERÃO NÃO ESTAR TODOS DISPONÍVEIS EM TODOS OS MERCADOS.  
ELKÉPZELHETŐ, HOGY BIZONYOS KIEGÉSZÍTŐK A TE ORSZÁGODBAN NEM ELÉRHETŐEK.  
部分内容可能不适用于某些国家/地区

[LEGO.COM/NEXOKNIGHTS](http://LEGO.COM/NEXOKNIGHTS)





# NEXO KNIGHTS



70357



70356



70355



70354



70353



70361



70362



70363



70364



70365



70366



70373



All your LEGO® fun in one app



Minifigure yourself



Share



Create



Check availability of LEGO LIFE in your country now on [LEGO.com/life](http://LEGO.com/life)  
Ask parents' permission first.

Controlla la disponibilità di LEGO LIFE nel tuo paese su [LEGO.com/life](http://LEGO.com/life)  
Chiedere prima il permesso ai genitori.

Apple and the Apple logo are trademarks of Apple Inc., registered in the U.S. and other countries. App Store is a service mark of Apple Inc. Google Play is a trademark of Google Inc.

Auf [LEGO.com/life](http://LEGO.com/life) erfährst du jetzt, ob LEGO LIFE in deinem Land verfügbar ist  
Bitte frage erst deine Eltern um Erlaubnis.

Consulta si LEGO LIFE está disponible en tu país en [LEGO.com/life](http://LEGO.com/life)  
Pide antes permiso a tus padres.

Ellenőrizd a LEGO LIFE elérhetőségét a lakóhelyeden, most a [LEGO.com/life](http://LEGO.com/life) honlapon!  
Először kérj engedélyt a szüleidtől!

Vérifie la disponibilité de LEGO LIFE dans ton pays sur [LEGO.com/life](http://LEGO.com/life)  
Demande d'abord l'autorisation d'un parent.

Verifica agora a disponibilidade de LEGO LIFE no teu país em [LEGO.com/life](http://LEGO.com/life)  
Pede primeiro permissão aos teus pais.

访问 [LEGO.com/life](http://LEGO.com/life) 网站, 查看乐高生活系列是否已在你在国家上线。先请求家长的许可。

LEGO, the LEGO logo, the Minifigure, the Brick and Knob configurations and the LIFE logo are trademarks of the LEGO Group. ©2017 The LEGO Group.





LEGO, the LEGO logo and NEXO KNIGHTS are trademarks of the LEGO Group. ©2017 The LEGO Group. 6209992

OUT NOW / MAINTENANT DISPONIBLE / JETZT ERSCHIENEN  
YA DISPONIBLE / JÁ DISPONÍVEL / MEGJELENT / 现已上市  
OFFERT DÈS MAINTENANT / YA ESTÁ DISPONIBLE



www.pegi.info  
PROVISIONAL



LEGO.com/worlds

LEGO WORLDS software © 2017 TT Games Ltd. Produced by TT Games under license from the LEGO Group. LEGO, the LEGO logo, the Brick and the Knob configurations and the Minifigure are trademarks of the LEGO Group. © 2017 The LEGO group. All other trademarks and copyrights are the property of their respective owners. All rights reserved. WB GAMES LOGO, WB SHIELD: ™ & © Warner Bros. Entertainment Inc. (s17) Separate purchase required.