



1123 betty

- (DE) Aufbau- und Gebrauchsanleitung für Art.-Nr. 1123
**FÜR SPÄTERES NACHSCHLAGEN
AUFBEWAHREN.**
- (GB) Instructions for assembly and use for Art. No. 1123
PLEASE KEEP FOR FURTHER REFERENCE.
- (FR) Instructions de montage et d'emploi pour article n° 1123
**IMPORTANT! A CONSERVER POUR DE
FUTURS BESOINS DE REFERENCE.
A LIRE ATTENTIVEMENT.**
- (NL) Montage- en gebruiksaanwijzing voor art. nr. 1123
BEWAAR VOOR LATERE RAADPLEGING.
- (IT) Istruzioni di montaggio e uso per l'art. n°. 1123
**CONSERVATE QUESTA DESCRIZIONE PER POTER
FAR RIFERIMENTO AD ESSA IN UN SECONDO
MOMENTO.**
- (DK) Installations- og brugsanvisning for art.-nr. 1123
MONTERINGEN BØR FORETAGES I RO OG FRED.
- (ES) Instrucciones de uso y de montaje para Art. -Núm. 1123
**GUÁRDELAS PARA PODER LEERLAS POSTERI-
ORMENTE EN CASO NECESARIO.**
- (HU) Összeszerelési és használati útmutató következő cikkszámhoz: 1123
**JÖVŐBENI TÁJÉKOZTATÓHOZ KÉRJÜK, A
LEÍRÁST ŐRIZZE MEG.**
- (FI) Asennus- ja käyttöohje, art. nro 1123
SÄILYTÄ OHJE MYÖHEMPÄÄ TARVETTA VARTEN.
- (SI) Navodila za montažo in uporabo za arikel-št. 1123
NAVODILO SHRANITE ZA KASNEJŠO KONTROLO.
- (HR) Upute za sastavljanje i uporabu artikla broj 1123
SAČUVAJTE IH ZA BUDUĆU PRIMJENU.
- (NO) Monterings- og bruksveiledning for art. nr. 1123
OPPBEVAR DEN FOR SENERE BRUK.



1123 betty

- (PL) Instrukcja montażu i obsługi do nr art. 1123
ZACHOWAĆ INSTRUKCJĘ DO PÓŹNIEJSZEGO WYKORZYSTANIA.
- (CZ) Návod na sestavení a používání pro výr. č. 1123
UCHOVEJTE JEJ K POZDĚJŠÍMU NAHLÉDNUTÍ.
- (PT) Instruções de montagem e uso para o art. n° 1123
GUARDE-AS PARA PODER CONSULTÁ-LAS POSTERIORMENTE.
- (TR) Ürün No. 1123 için kurma ve kullanım talimatı
SONRADAN OKUMAK İÇİN SAKLAYINIZ.
- (RU) Инструкции по сборке и использованию для артикула № 1123
ПОЖАЛУЙСТА, СЛЕДУЙТЕ ИНСТРУКЦИИ.
- (SK) Návod na montáž a použitie k prod. č.: 1123
TENTO NÁVOD SI USCHOVAJTE PRE NESKORŠIE POUŽITIE.
- (SE) Uppbyggnads- och bruksanvisning för art.nr. 1123
SPARA FÖR ATT KUNNA LÄSA IGEN LÄNGRE FRAM.
- (RS) Uputstvo za sastavljanje i primenu art. br. 1123
SAČUVATI ZA KASNIJU UPOTREBU.
- (JP) 組み立て・使用説明書 品番 1123
この説明書を大切に保管してください。
- (CN) 安装与使用说明 - 型号 1123
请妥善保存说明书以备今后查阅。
- (KR) 제품-No. 의 조립 및 사용 설명서 1123
나중에 참조할 수 있도록 설명서를 보관하십시오.

Teileliste
List of parts as illustrated
Liste de pièces comme illustrée
Onderdelenlijst
Listino pezzi
Indhold
Lista de piezas
Alkotóelemek jegyzéke
Osaluettelo

Seznam elementov
Popis dijelova
Delliste
Wykaz części
Seznam součástí
Lista de peças
Parça listesi
Перечень деталей
Zoznam súčiastok

Artikellista
Spisak delova
パーツリスト
零部表
부품 목록

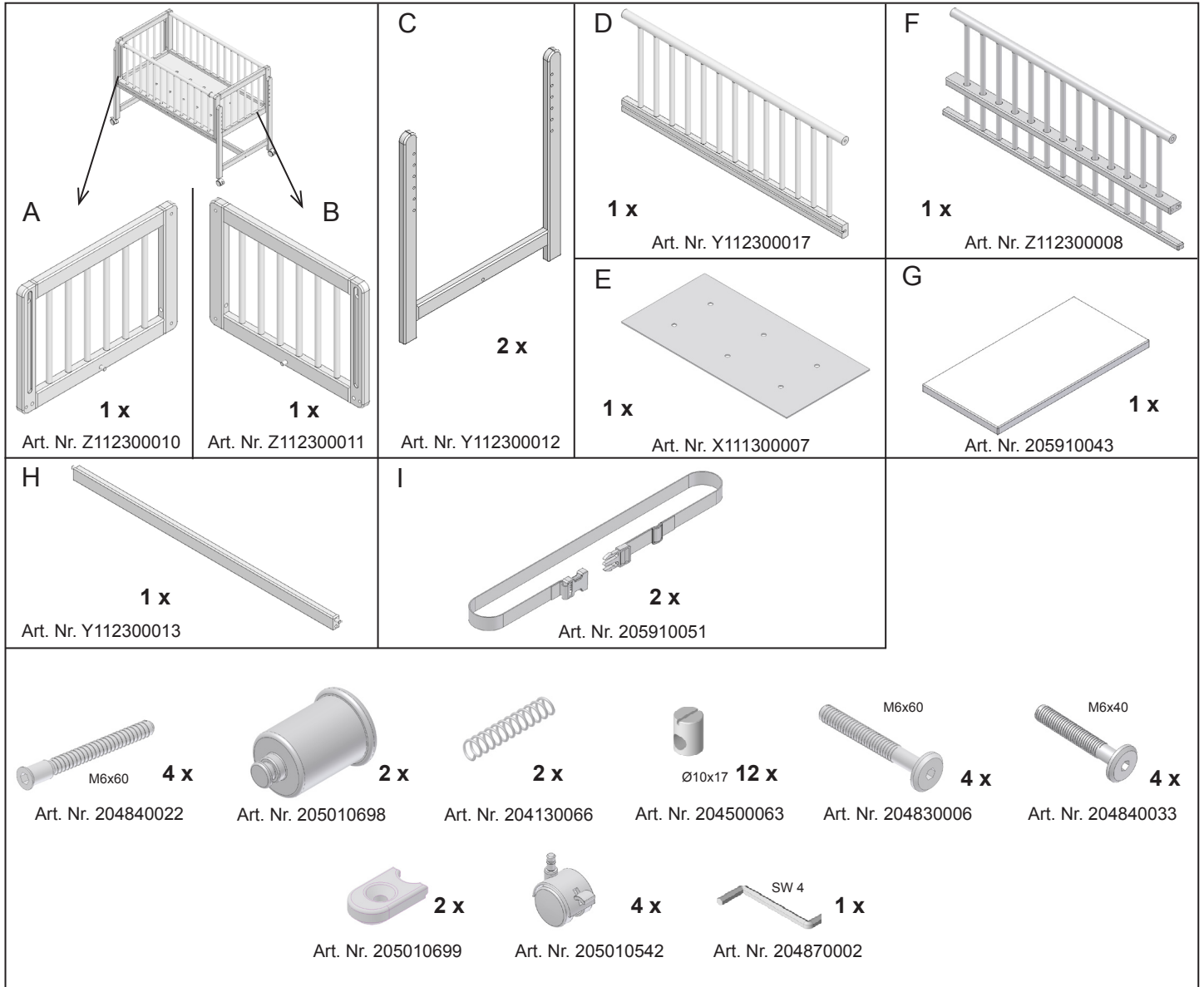
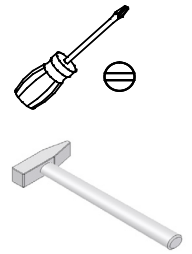

1

A

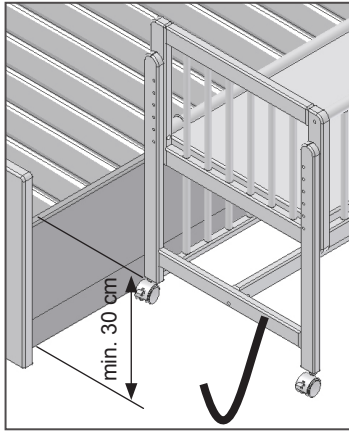

B

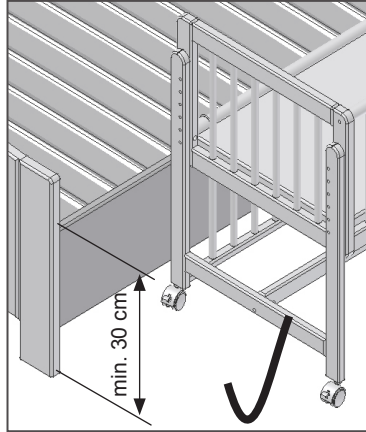

C

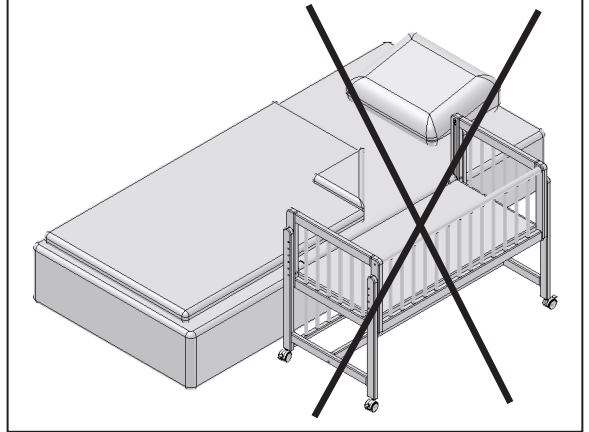

2

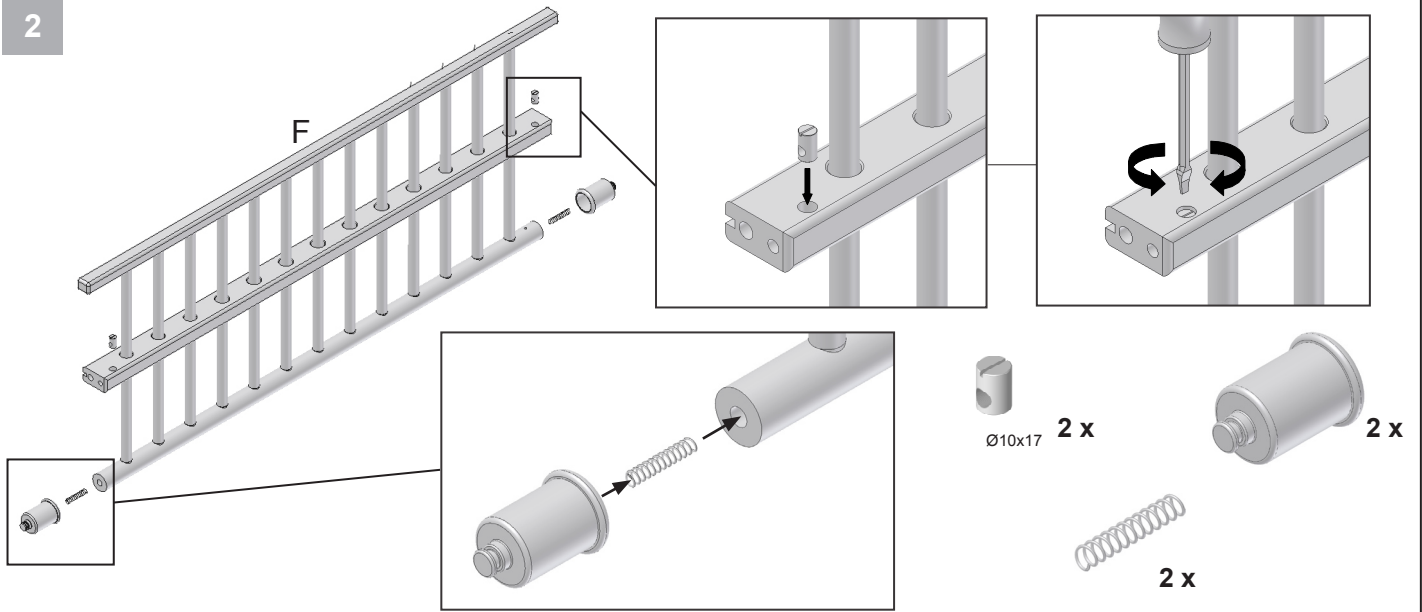

3

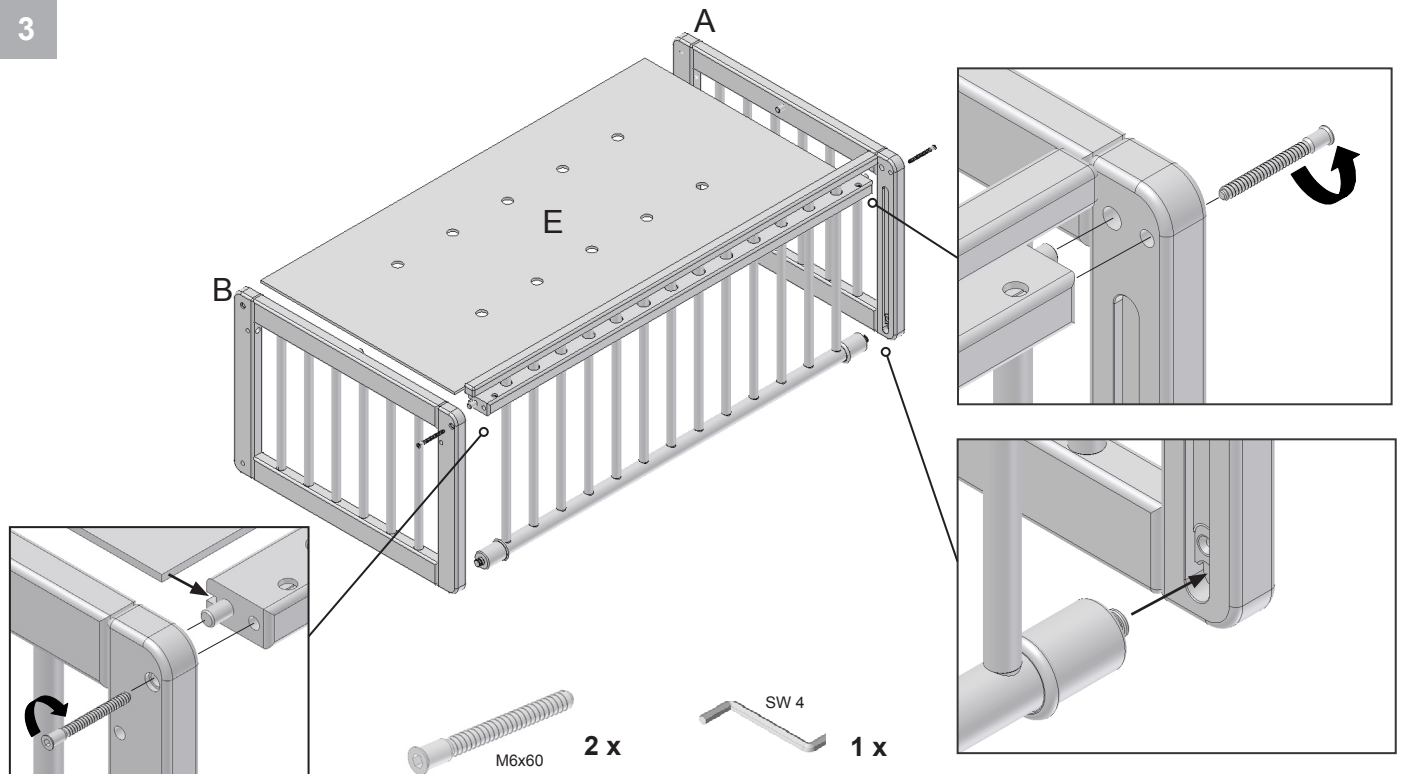

4

SW 4 1 x M6x60 2 x

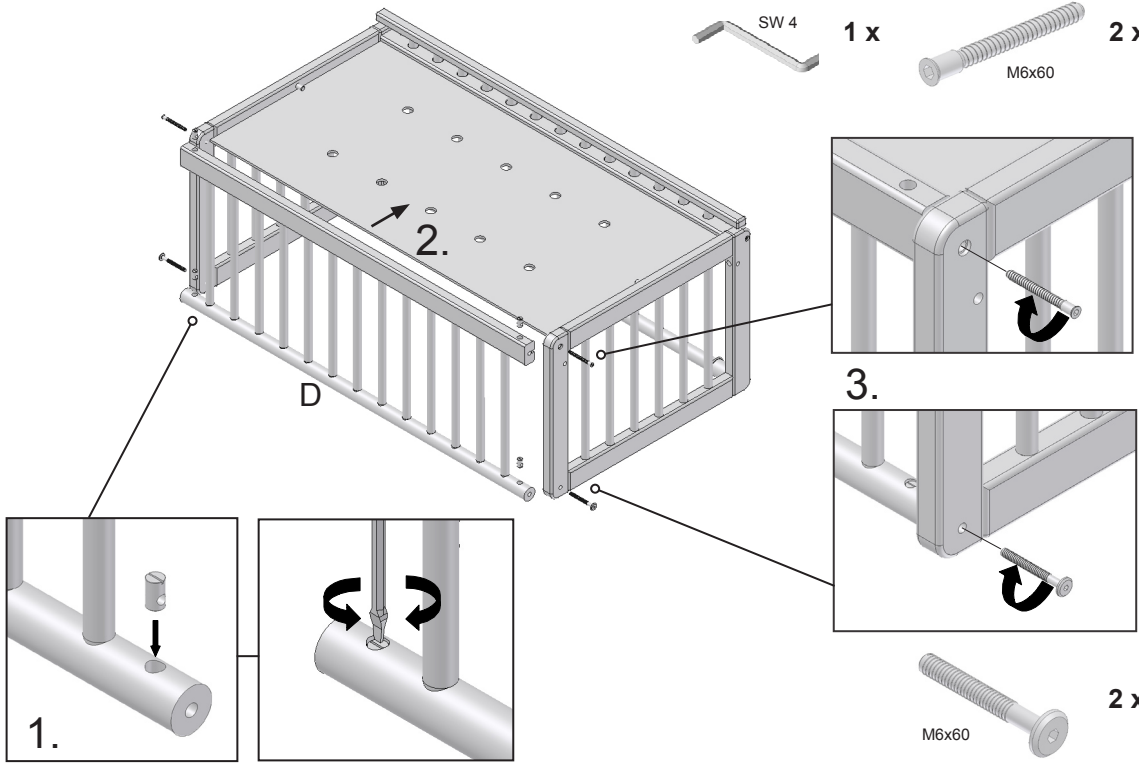

5

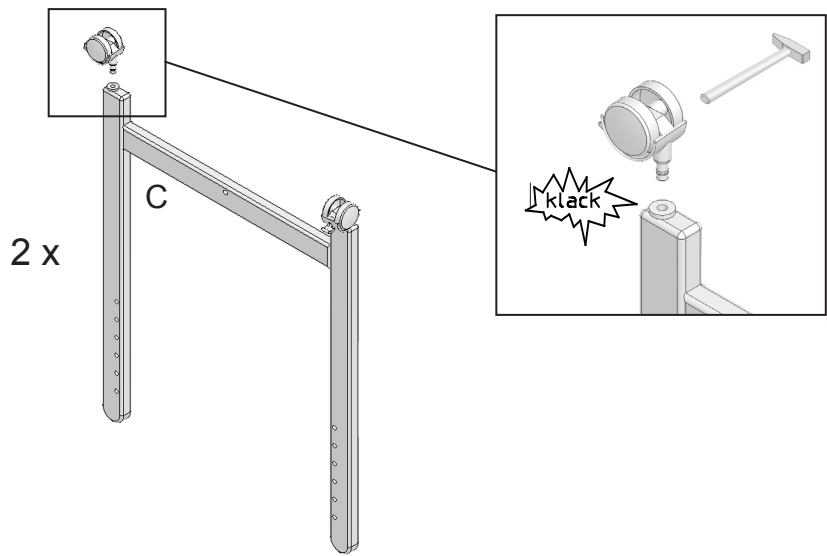

4 x

6

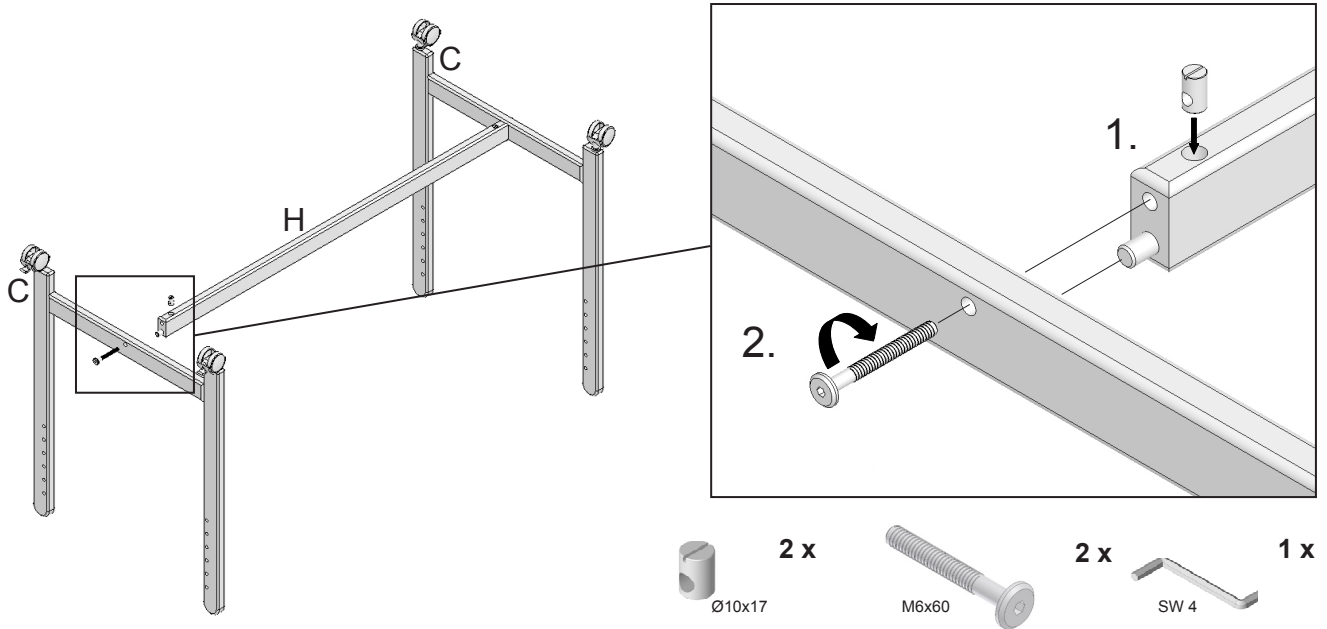

7

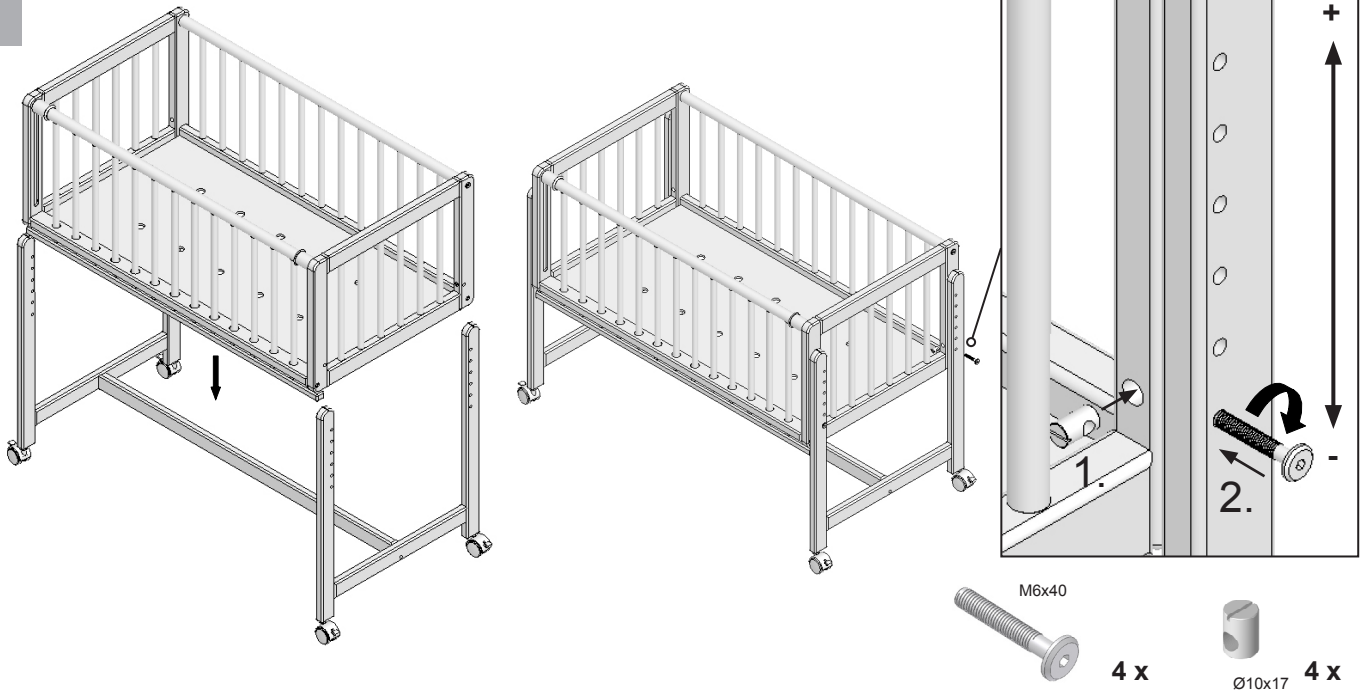

8

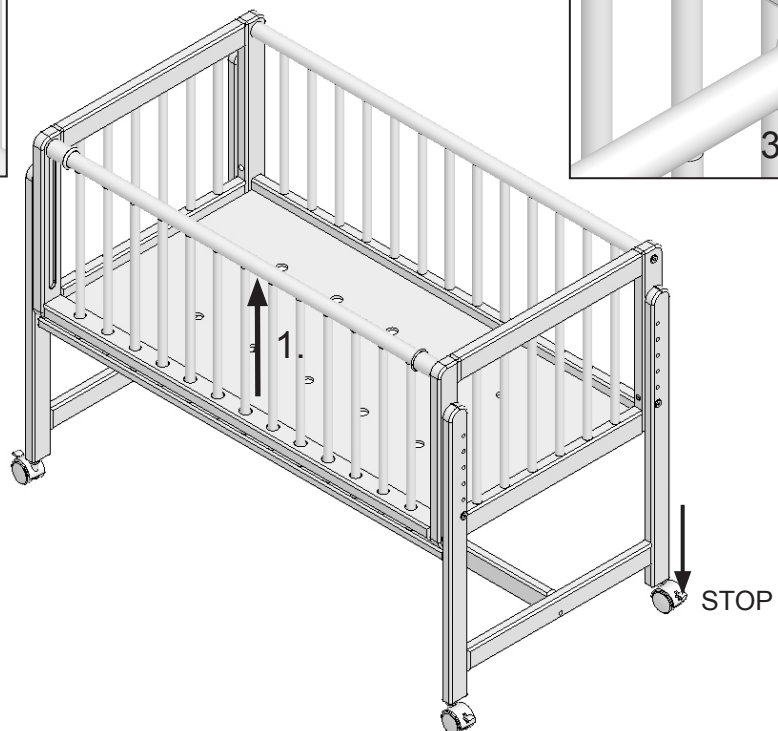
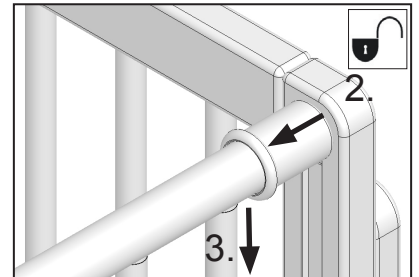
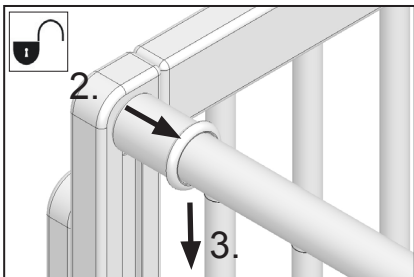
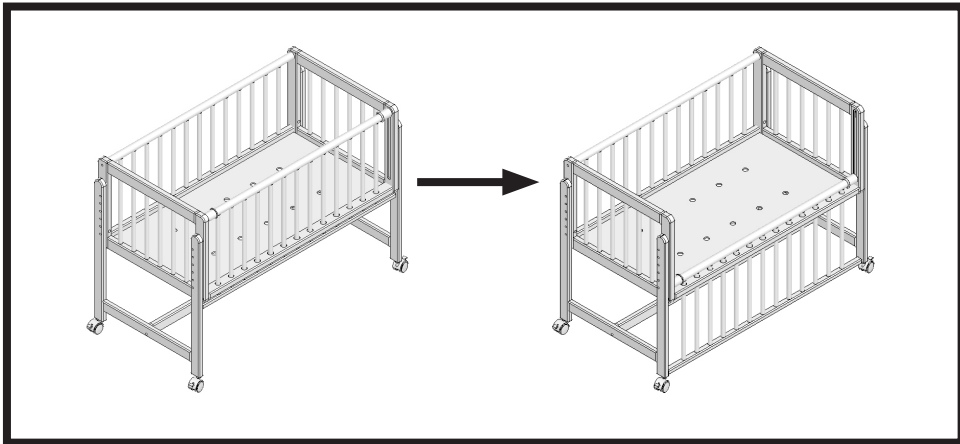

9

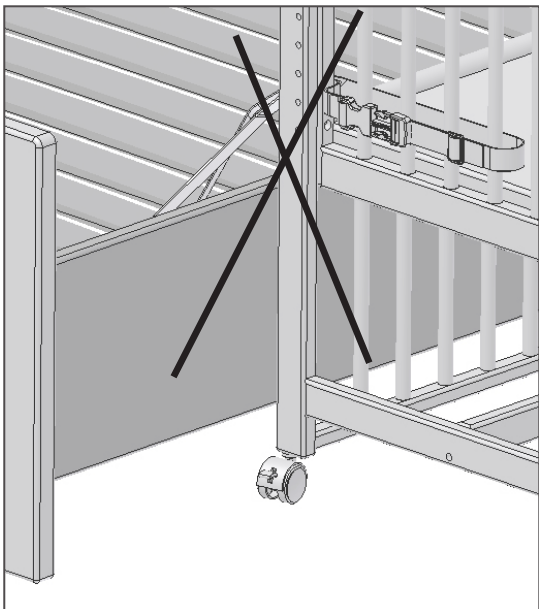
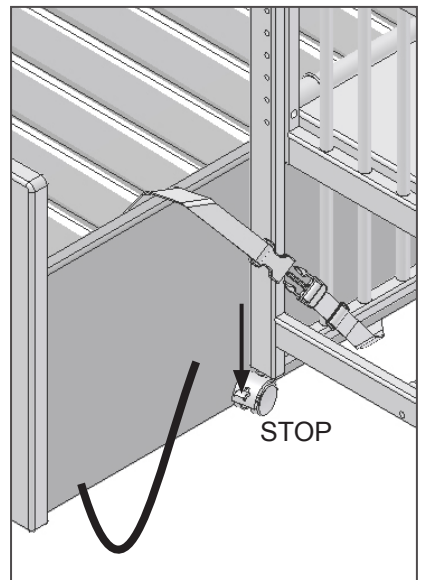
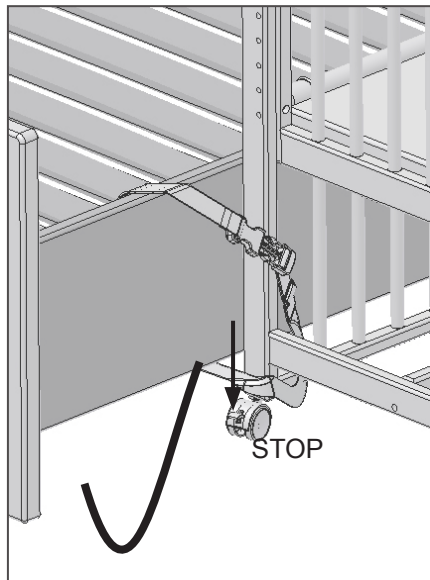
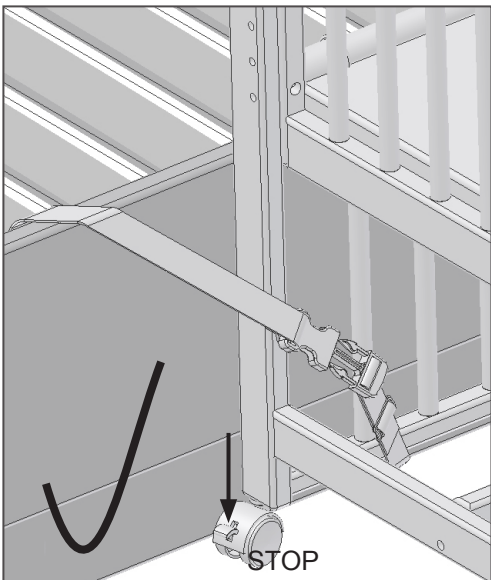
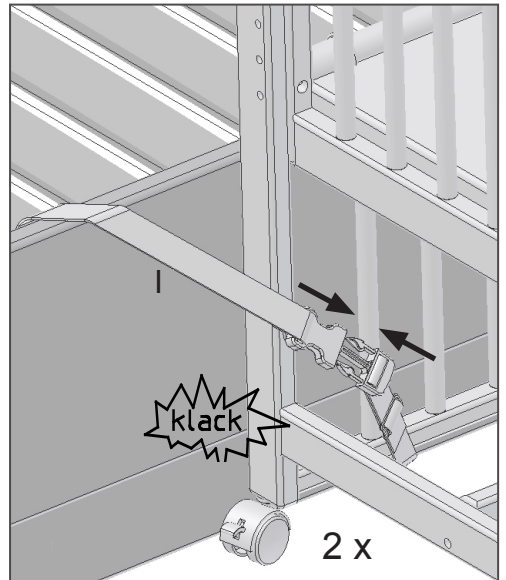
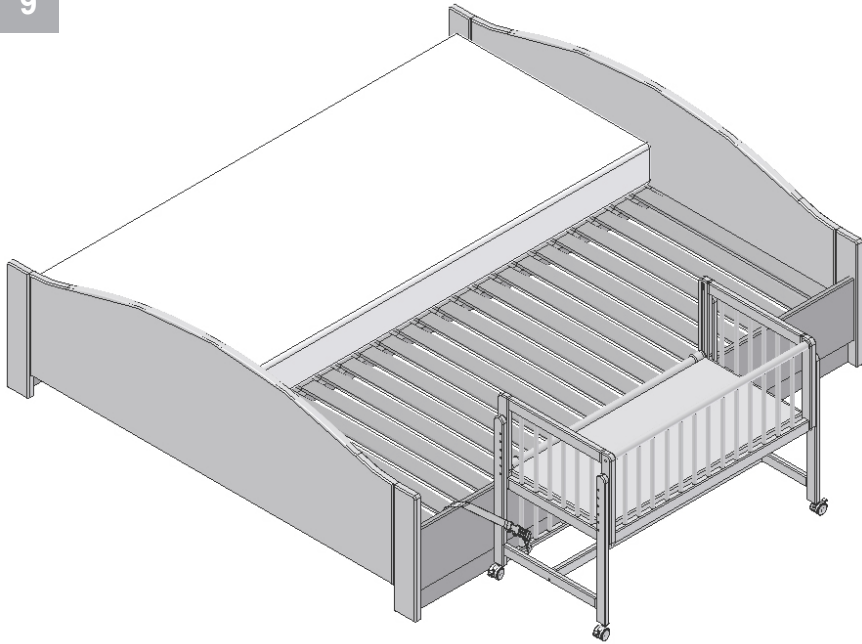

10

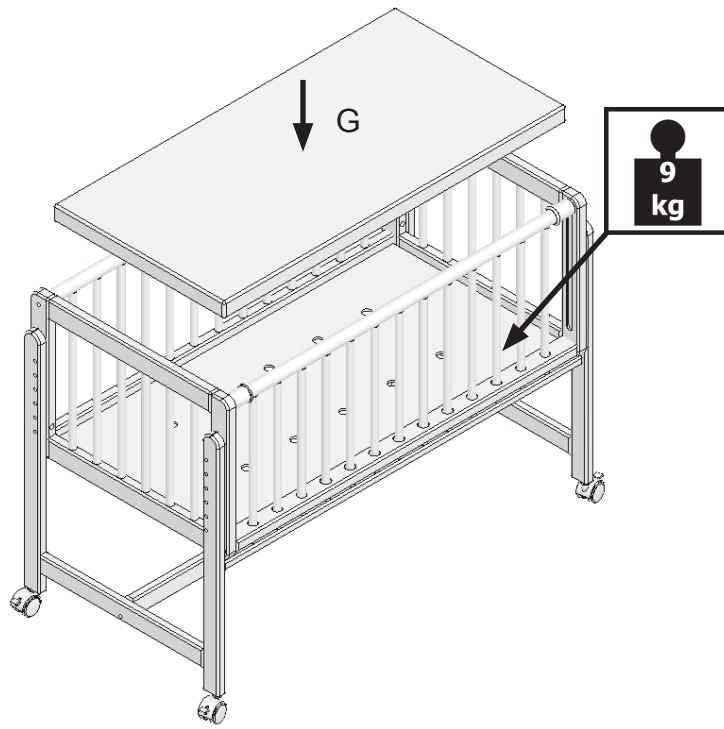

11

