



CREATOR

31056

3 IN 1



LEGO.com/creator

1

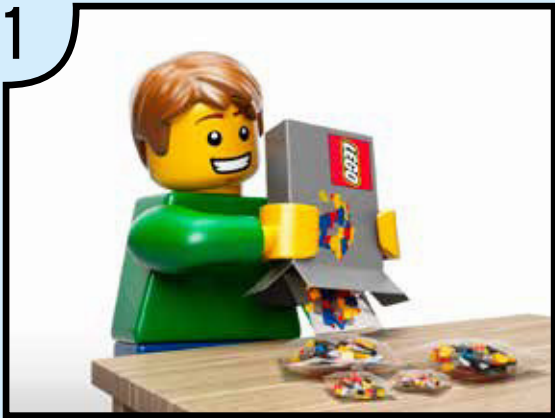

2



3



4



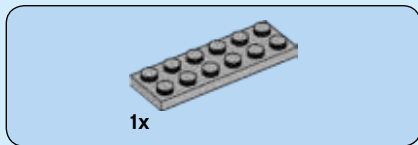
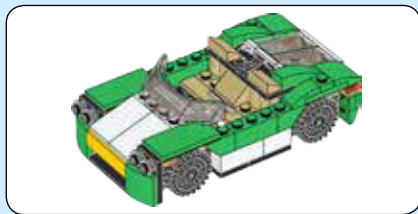

1

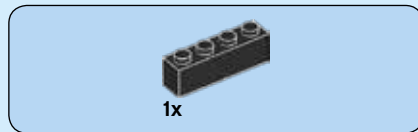
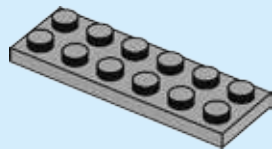

2

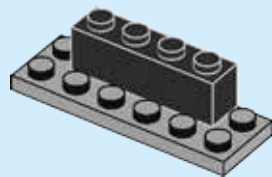

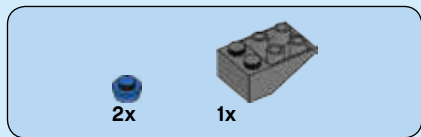

3

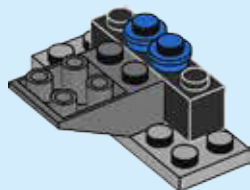

4

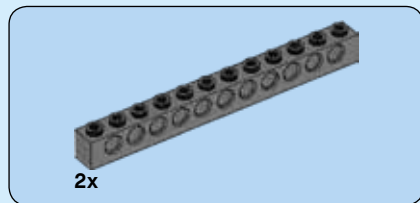

4

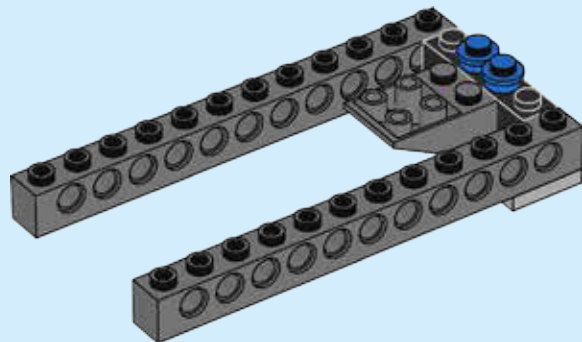

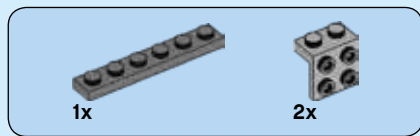

5

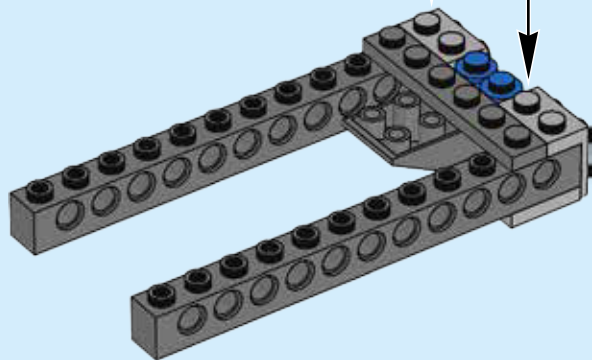
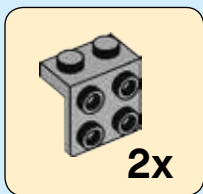

6

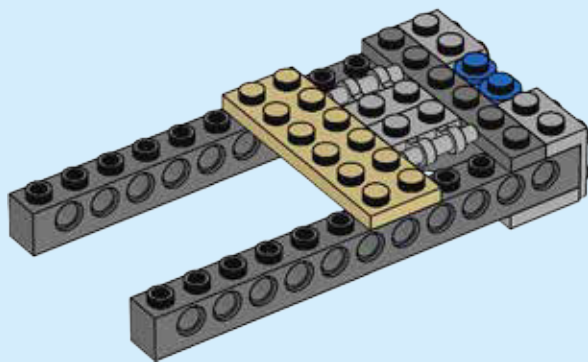



2x

7



2x

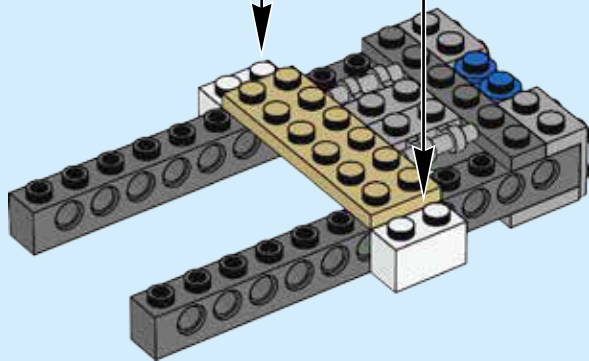

6



8

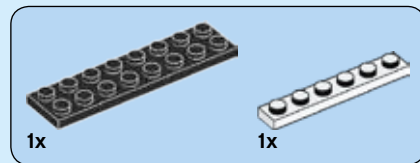
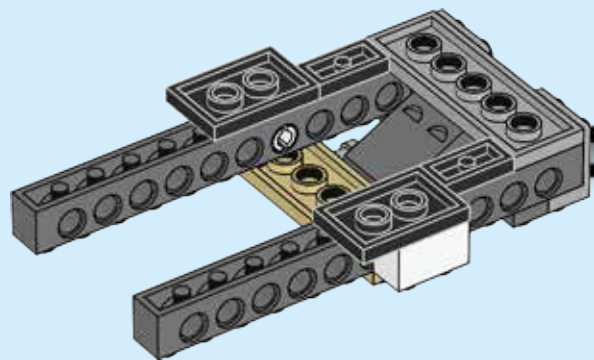
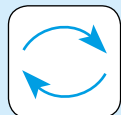

9

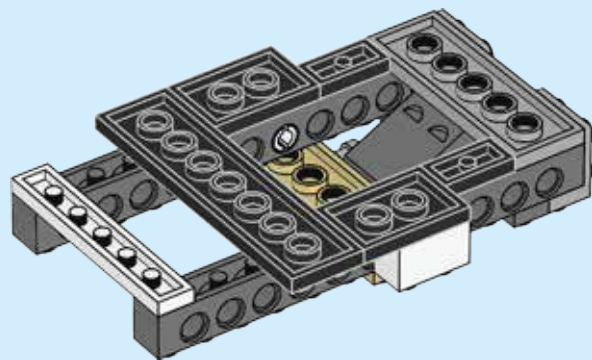



2x



2x

10

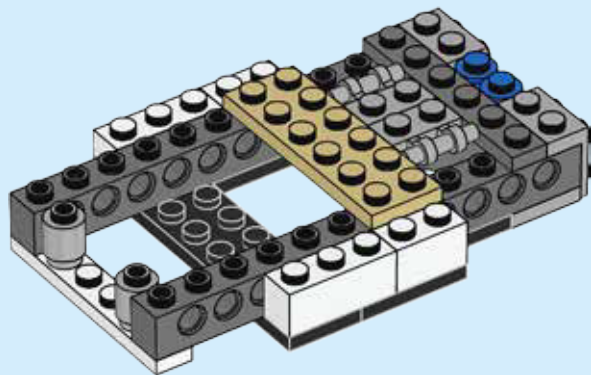
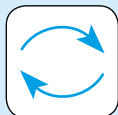



11

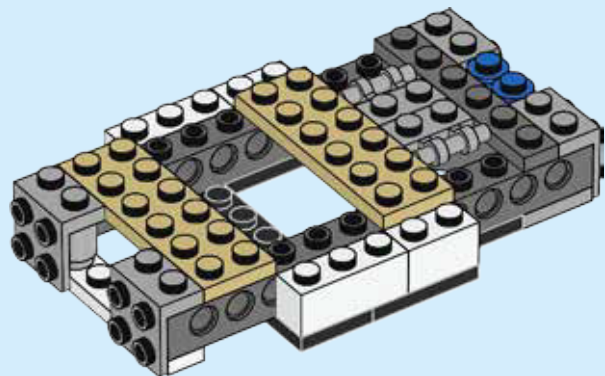

12

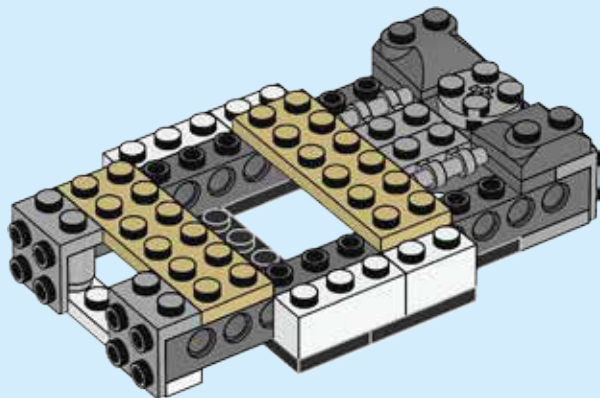



2x



2x

13

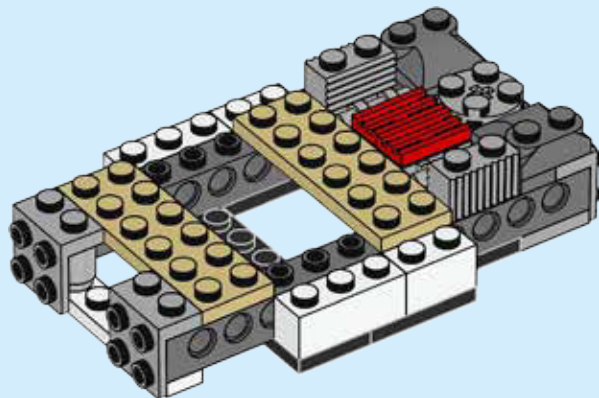

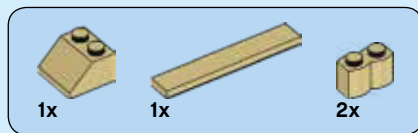

14

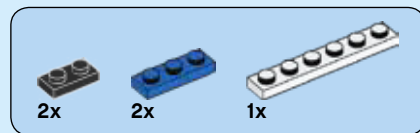
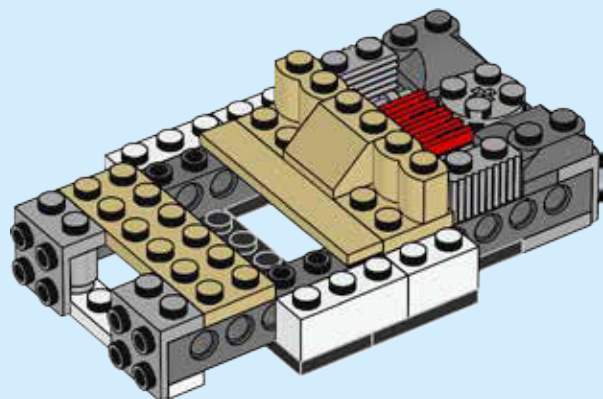

15

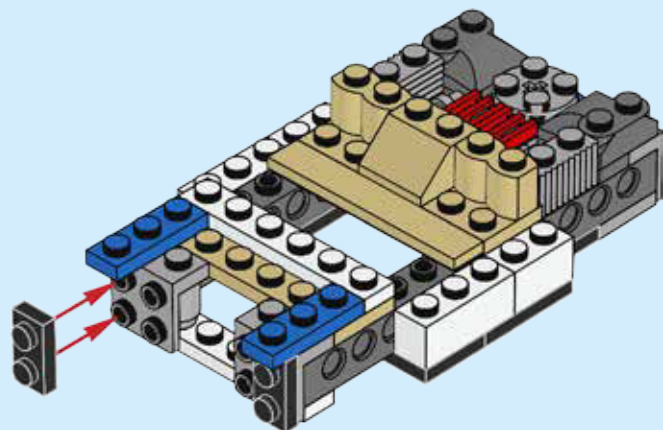



2x



2x

16

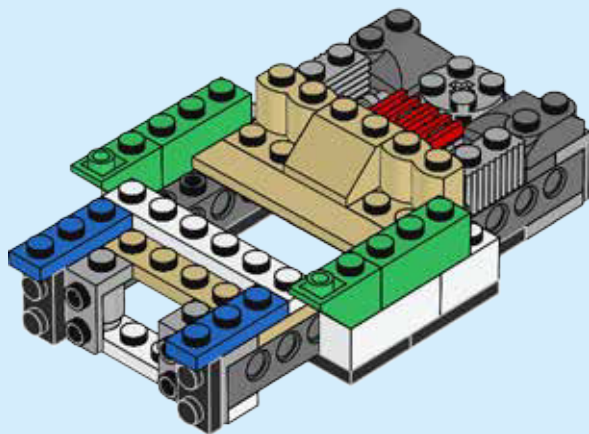



2x



1x

17

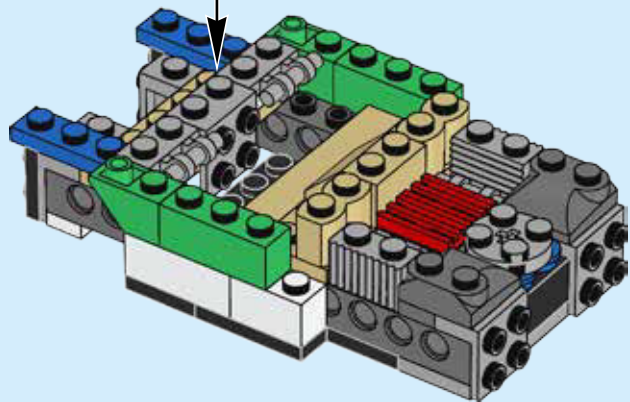
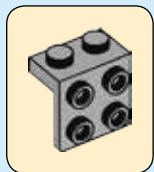

2x



2x

18

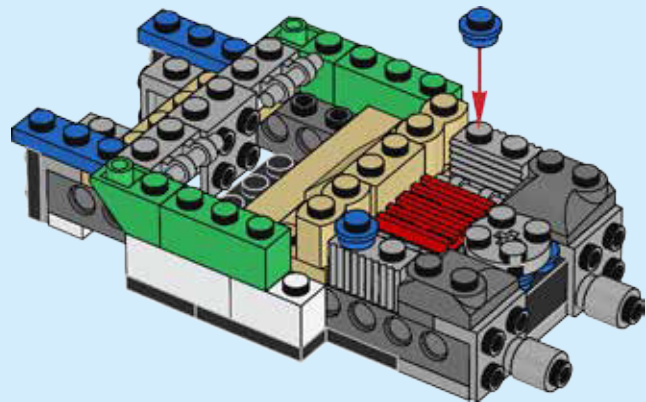

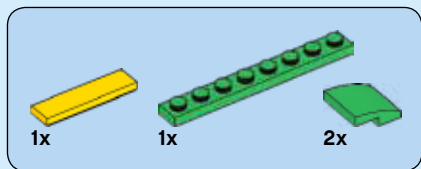

19

1

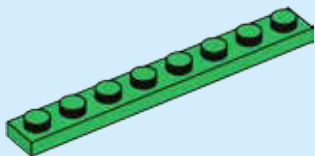

2

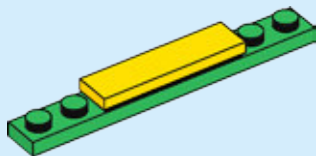

3

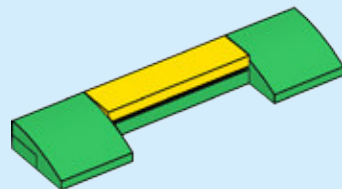

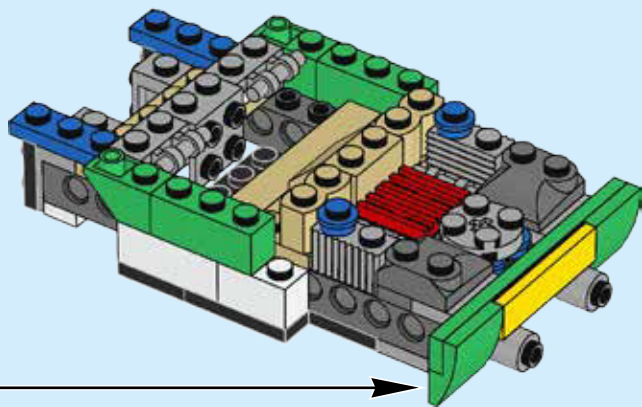

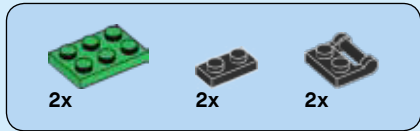

20

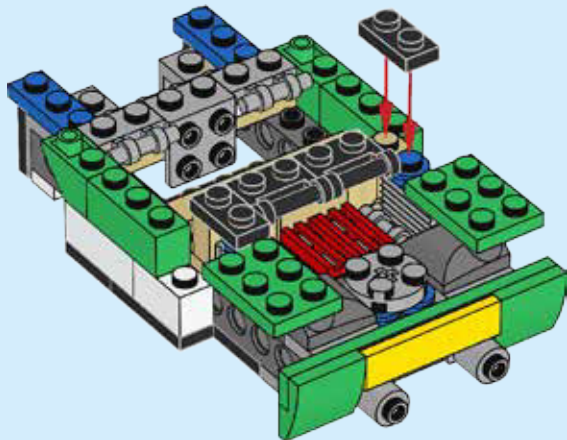



2x

21

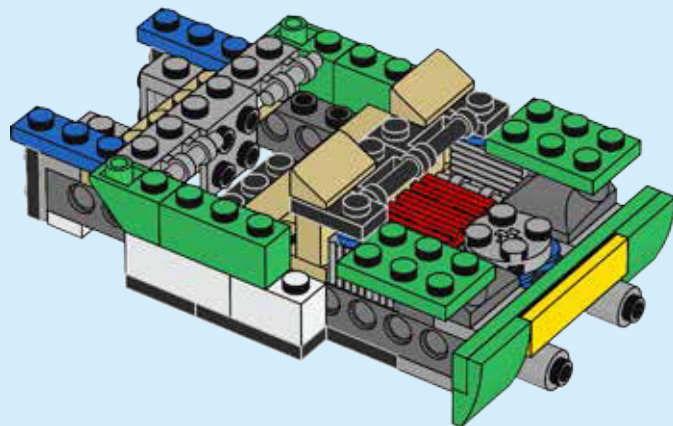



2x

22

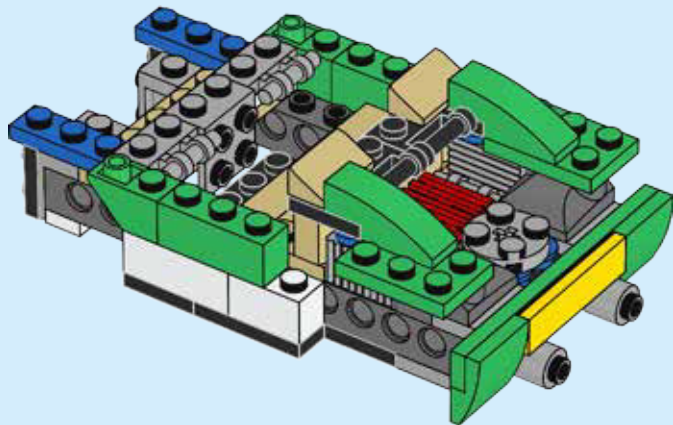

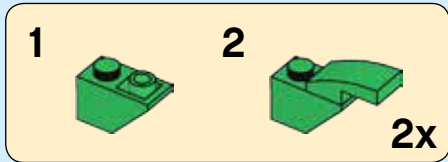

23

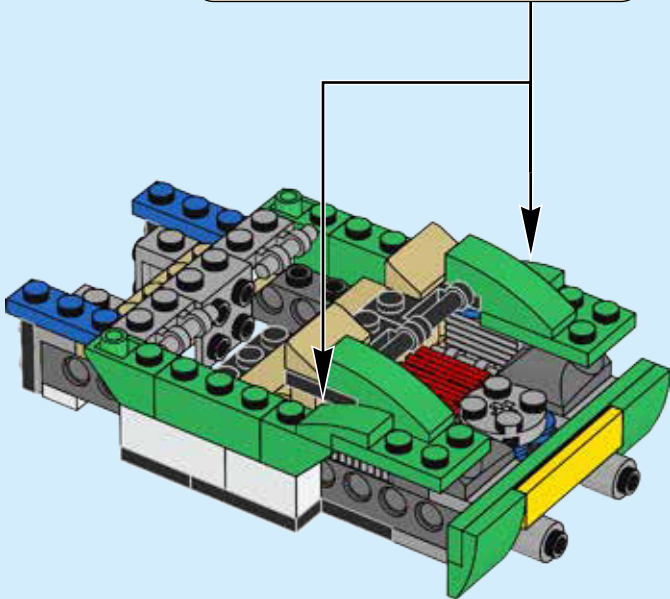



24

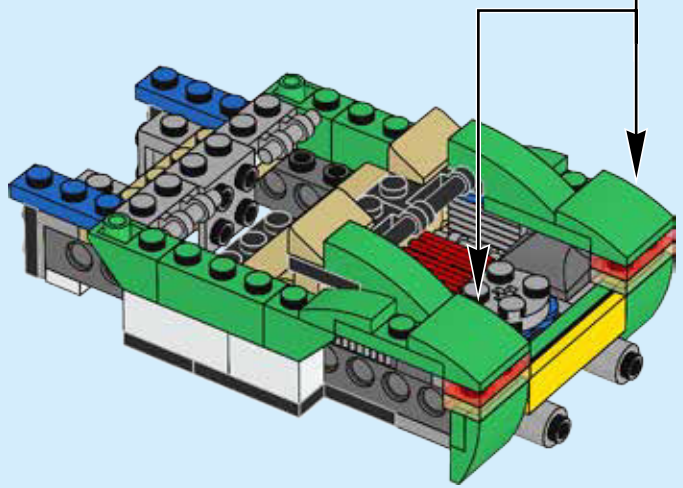



2x

25

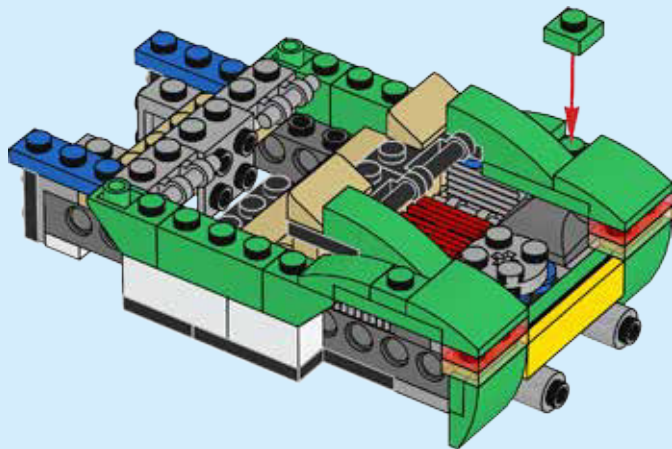

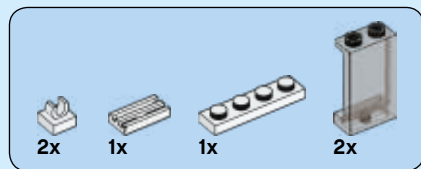

26

1



2

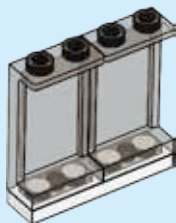

3

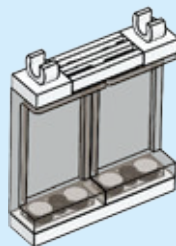

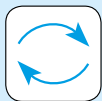

4

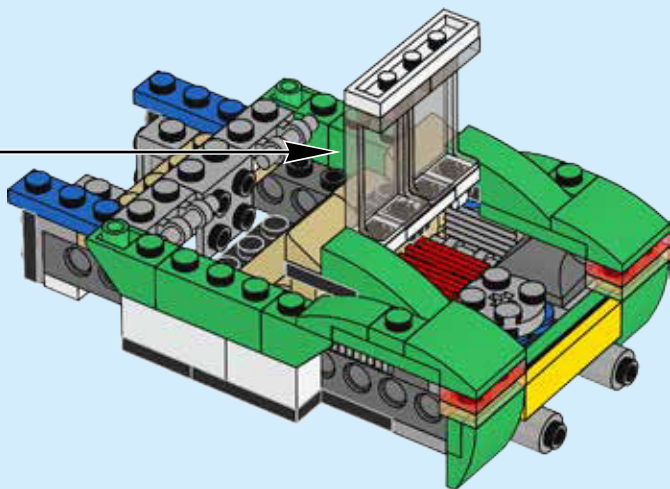
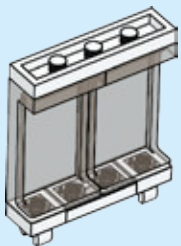

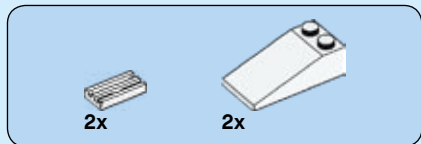

27

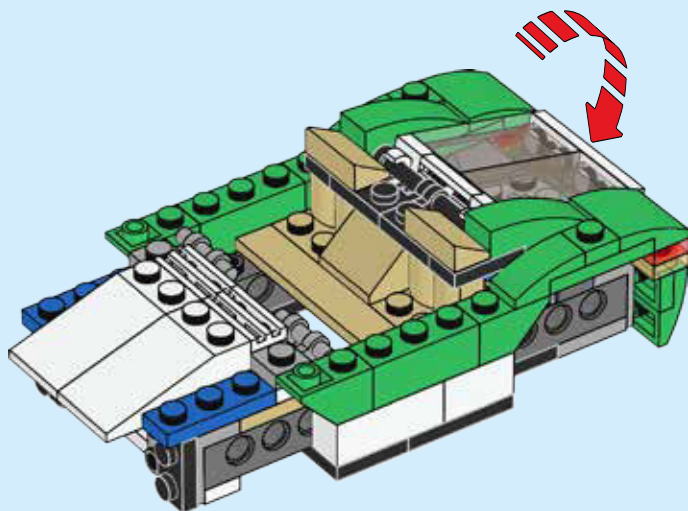

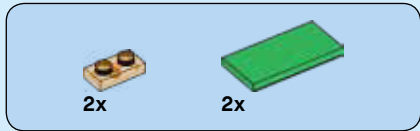

28

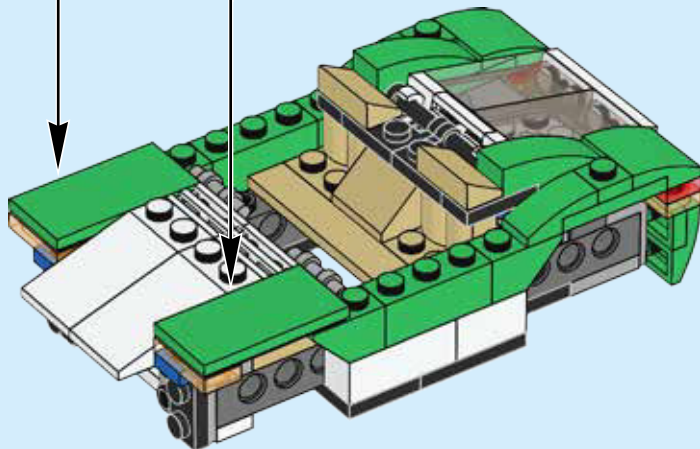
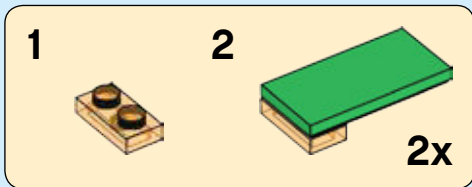

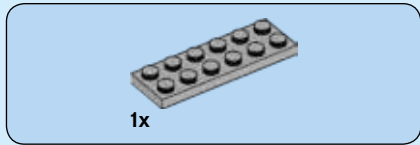
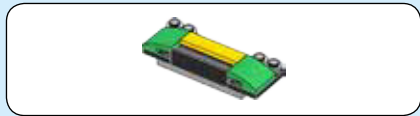

29

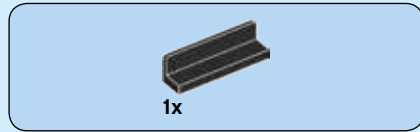
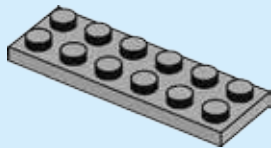

30

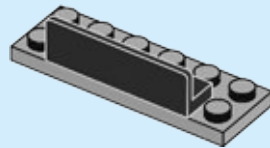

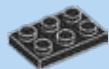

2x

31

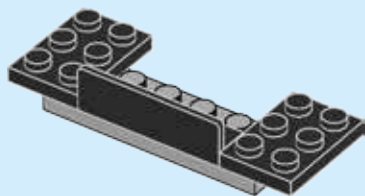

1x

32

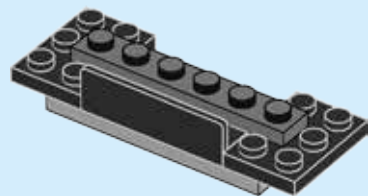



2x

33

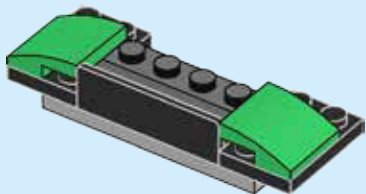

4x

34

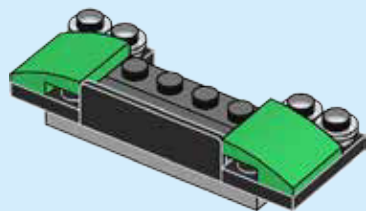

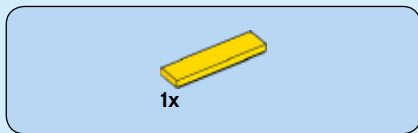

35

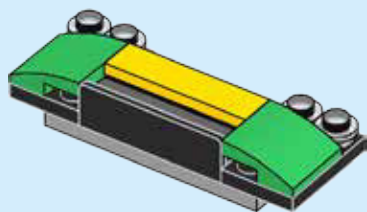

36

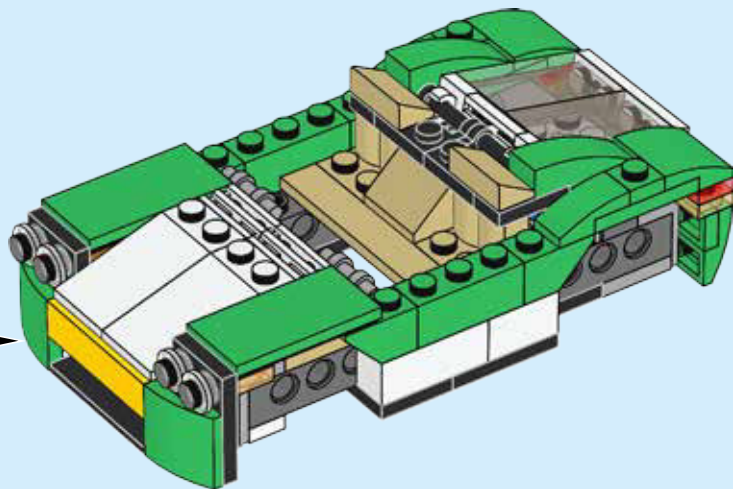



1x



1x

1



2



37

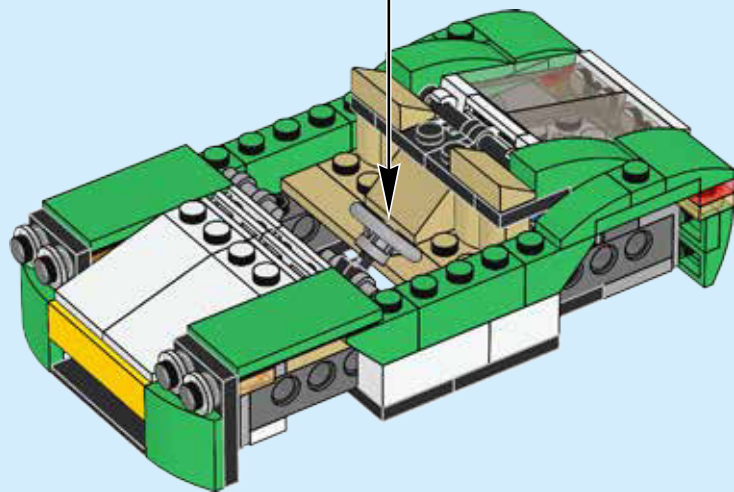



1x

38

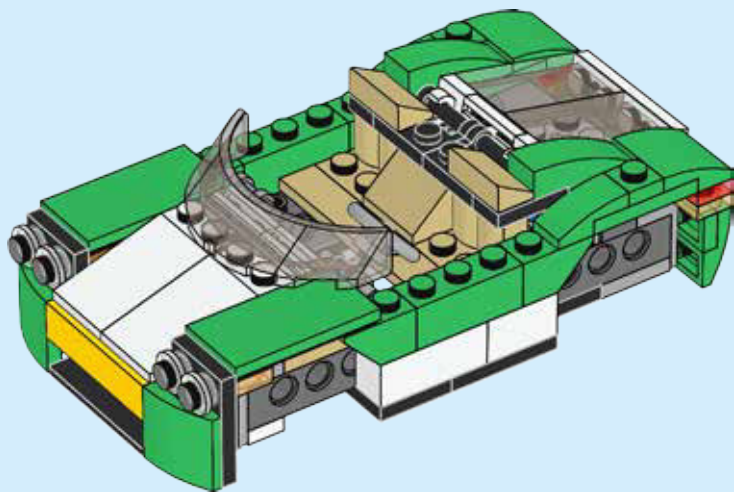

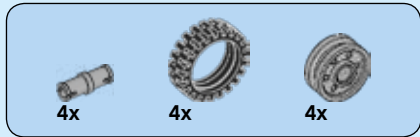

39

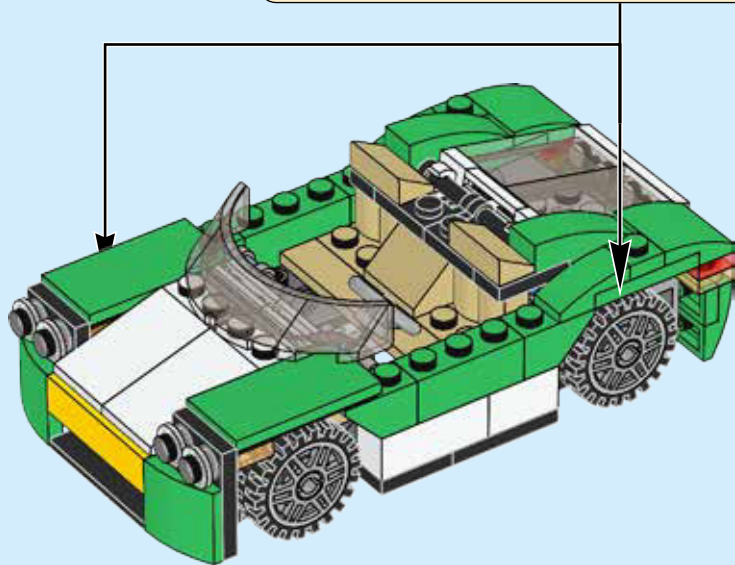
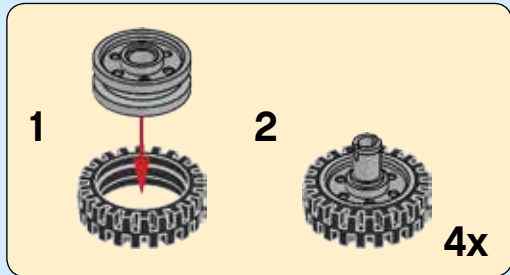



JANUARY 2017 / JANVIER 2017 / ENERO 2017



LEGO.com/worlds

LEGO WORLDS software © 2017 TT Games Ltd. Produced by TT Games under license from the LEGO Group. LEGO, the LEGO logo, the Brick and the Knob configurations and the Minifigure are trademarks of the LEGO Group. © 2017 The LEGO group. All other trademarks and copyrights are the property of their respective owners. All rights reserved. WB GAMES LOGO, WB SHIELD: ™ & © Warner Bros. Entertainment Inc. (s17)

Logiciel LEGO WORLDS © 2017 TT Games Ltd. Produit par TT Games avec l'autorisation du Groupe LEGO. LEGO, le logo LEGO, les configurations de briques et tenons et la minifigurine sont des marques de commerce du Groupe LEGO. © 2017 Le Groupe LEGO. Tous les autres droits d'auteur et marques de commerce sont la propriété de leurs propriétaires respectifs. Tous droits réservés. LOGO WB GAMES, LOGO WBIE, BOUCLEUR WB : ™ et © Warner Bros. Entertainment Inc. (s17)

LEGO WORLDS software © 2017 TT Games Ltd. Producido por TT Games bajo licencia de LEGO Group. LEGO, el logotipo de LEGO, la configuración del Ladrillo y de la Perilla, y la Minifigura son marcas comerciales de LEGO Group. © 2017 The LEGO Group. Todas las demás marcas comerciales y derechos de autor son propiedad de sus respectivos propietarios. Todos los derechos reservados. LOGOTIPO DE WB GAMES, LOGOTIPO DE WBIE, ESCUDO DE WB : ™ y © Warner Bros. Entertainment Inc. (s17)





31060



31054



31055





Minifigure yourself
 Transforme-toi en figurine
 Conviértete en una minifigura

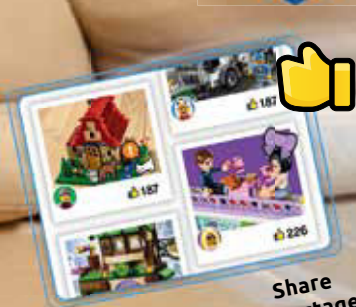

Share
 Partage
 Comparte



Create
 Crée
 Crea



All your LEGO® fun in one app
 Tout l'amusement LEGO® dans une appli
 Toda la diversión LEGO® en una app

Download on the
 App Store

GET IT ON
 Google play

Check availability of LEGO LIFE in your country now on LEGO.com/life
 Vérifie la disponibilité de LEGO LIFE dans ton pays sur LEGO.com/life
 Consulta si LEGO LIFE está disponible en tu país en LEGO.com/life

Ask parents' permission first.
 Demande d'abord l'autorisation d'un parent.
 Pide antes permiso a tus padres.

Apple and the Apple logo are trademarks of Apple Inc., registered in the U.S. and other countries.
 App Store is a service mark of Apple Inc. Google Play is a trademark of Google Inc.

LEGO, the LEGO logo, the Minifigure, the Brick and Knob configurations and the LIFE logo are trademarks and/or copyrights of the/sont des marques de commerce et/ou copyrights du/son marcas registradas, algunas de ellas protegidas por derechos de autor, de LEGO Group. ©2017 The LEGO Group. All rights reserved/Tous droits réservés/Todos los derechos reservados.

WIN

GO TO WWW.LEGO.COM/PRODUCTFEEDBACK AND
GIVE US YOUR SHORT **FEEDBACK** ABOUT THIS
LEGO® SET FOR A CHANCE TO WIN
A COOL LEGO PRIZE.

Terms & Conditions apply



LEGO.com/productfeedback

GEWINNE



Erzähle uns auf
www.LEGO.com/productfeedback

etwas über die Erfahrungen, die du mit
diesem LEGO® Set gemacht hast, und
sichere dir die Chance auf einen coolen
LEGO Preis!

Es gelten die Teilnahmebedingungen

GAGNE



Rends-toi sur
www.LEGO.com/productfeedback

et donne-nous quelques commentaires sur
ce produit LEGO® pour avoir une chance
de gagner un prix LEGO !

Voir Conditions Générales

GANAN



Visita
www.LEGO.com/productfeedback

y envíanos tu opinión acerca de este set
LEGO®. ¡Participarás en el sorteo de un
premio LEGO!

Términos y Condiciones aplicables

获取奖品



登录
www.LEGO.com/productfeedback

给出关于此乐高®套装的简短反馈，
就有机会获得炫酷乐高奖品

《条款及条件》适用

LEGO and the LEGO logo are trademarks of the/son des marques de commerce du/son marcas registradas de LEGO Group. ©2017 The LEGO Group.

6187062



CREATOR

31056

3 IN 1

A yellow shield-shaped icon containing the text "3 IN 1" in white, with a small blue book icon below the "1".

LEGO.com/creator

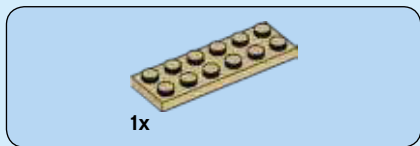
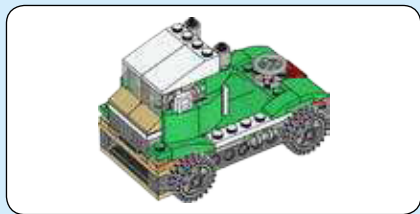

1

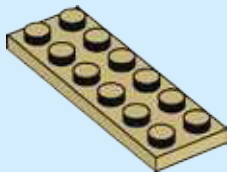

2

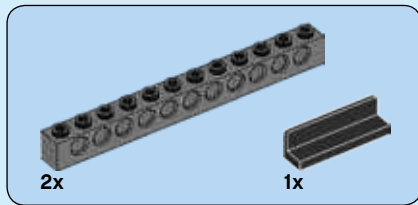

2

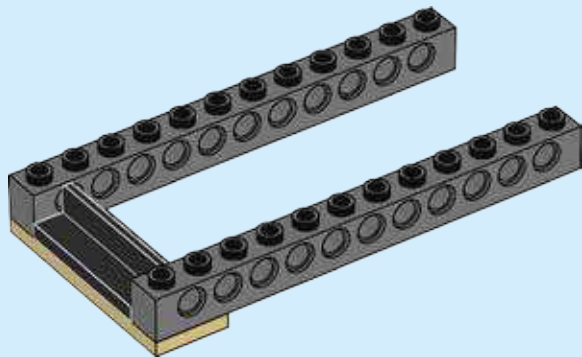



1x

3

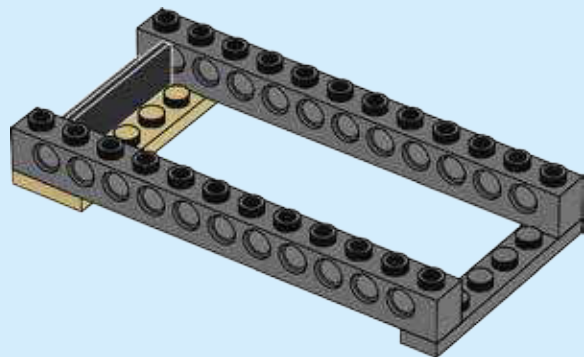

2x

4

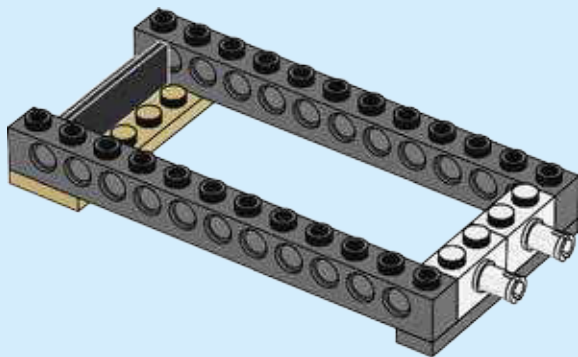

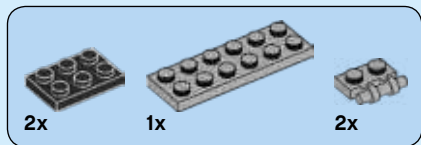

5

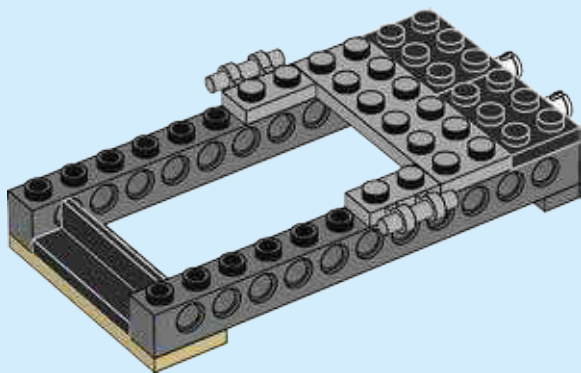

4

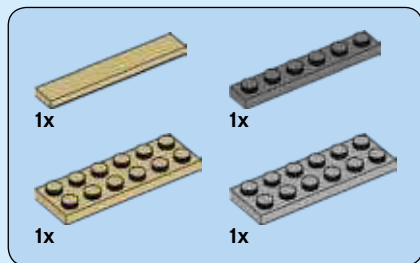

6

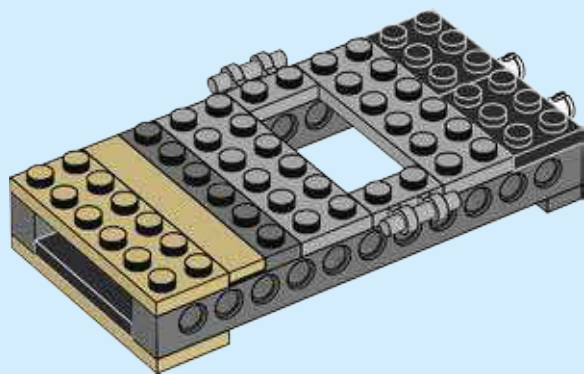

7

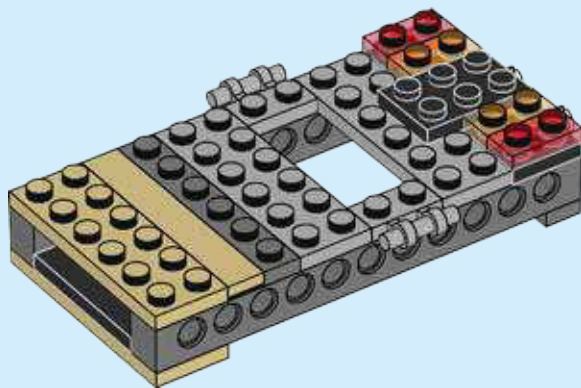

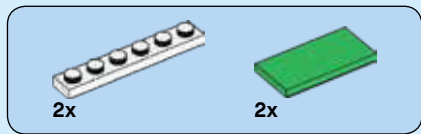

8

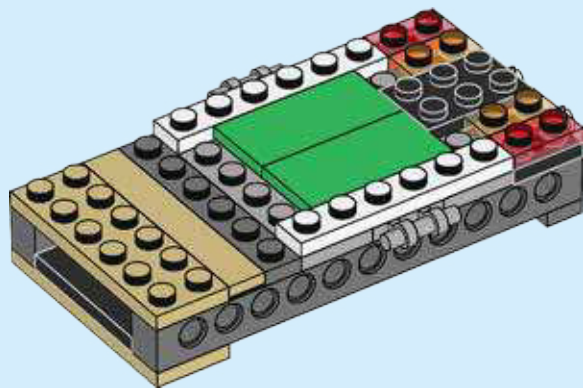



1x



2x

9

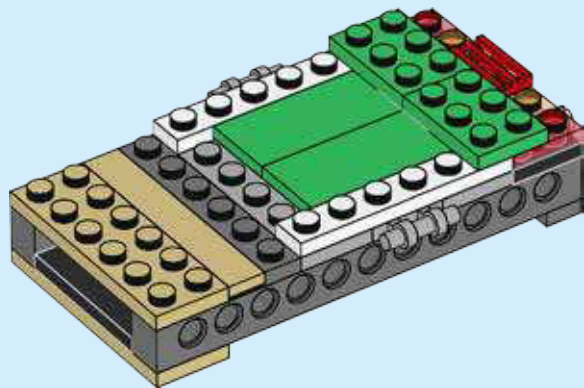

1x



2x

10

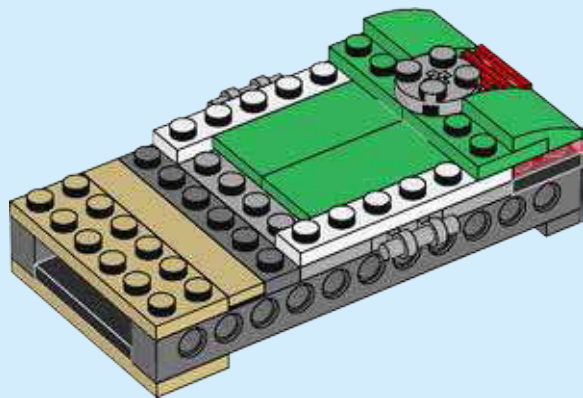



2x



1x

11

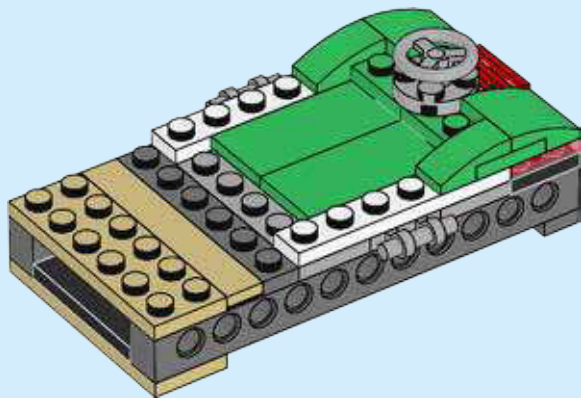



2x



2x

12

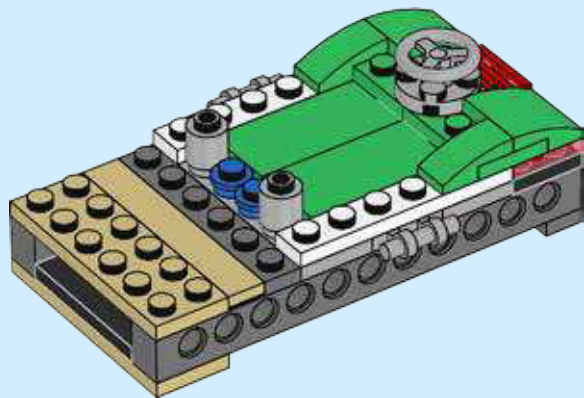

2x



2x

13

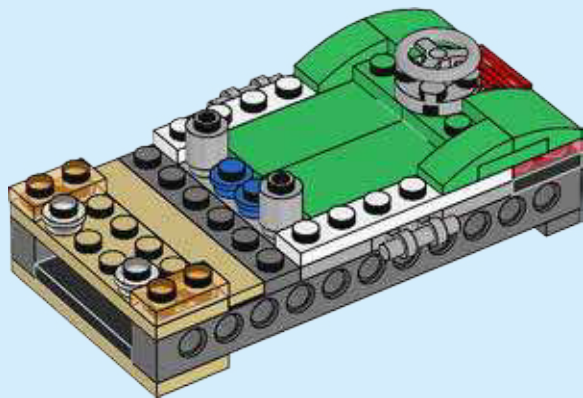

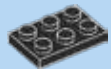

1x



2x

14

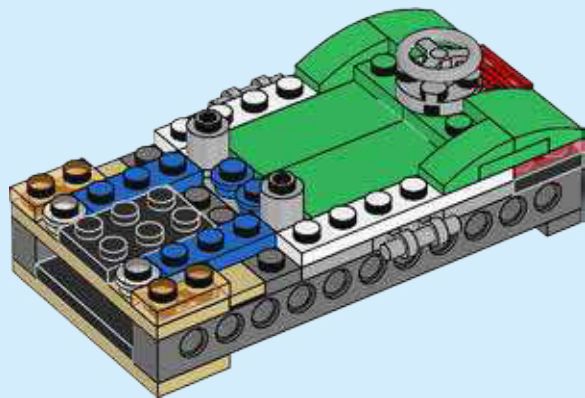



2x



2x

15

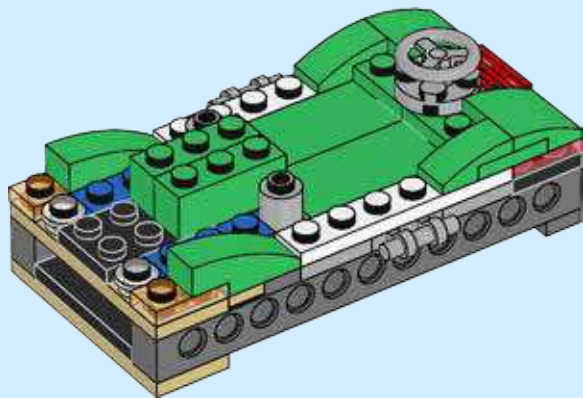



2x



2x

16

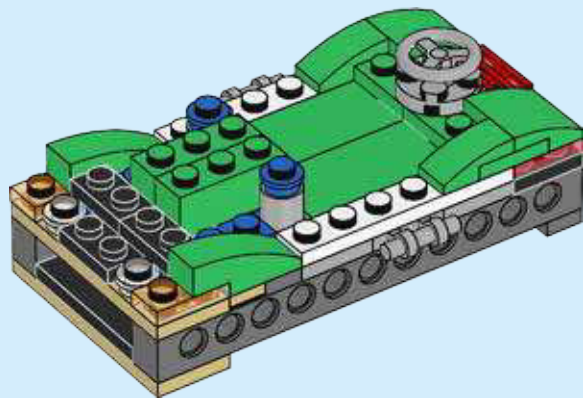



1x



2x

17

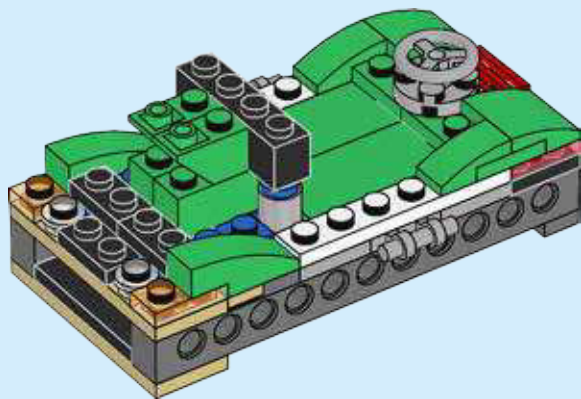

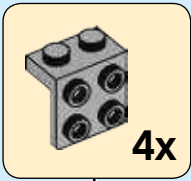
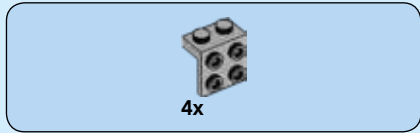

18

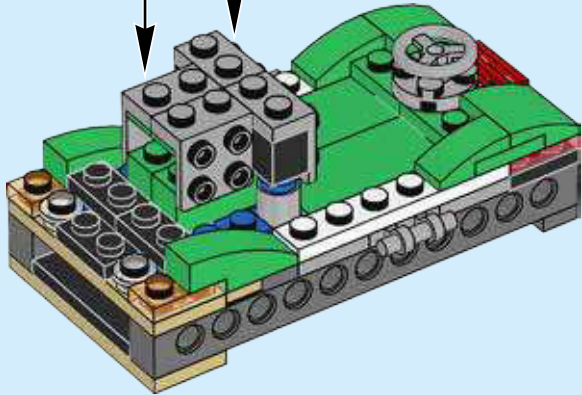



1x



2x

19

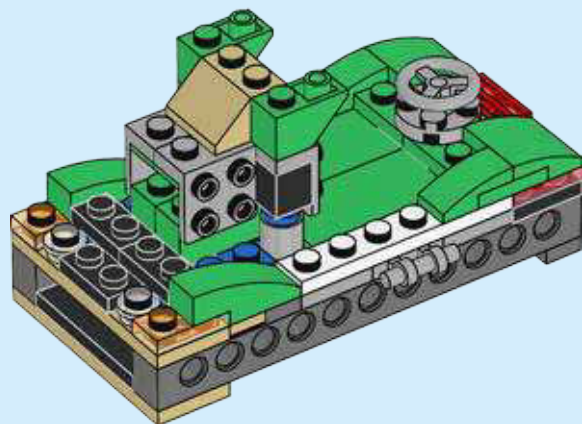



2x



2x

20

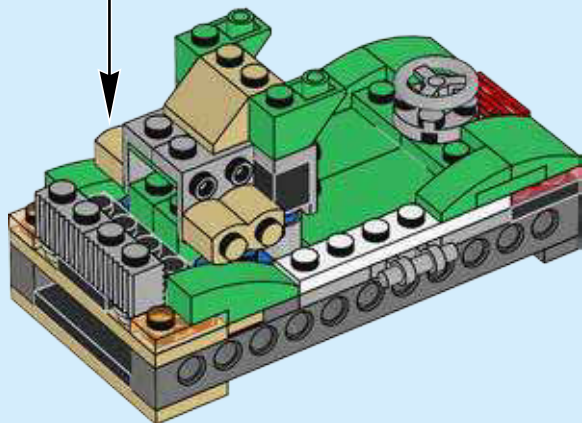

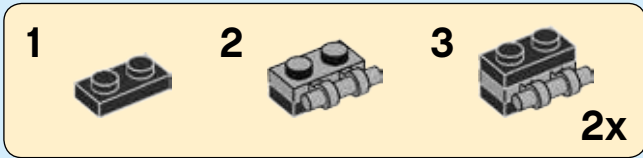

21

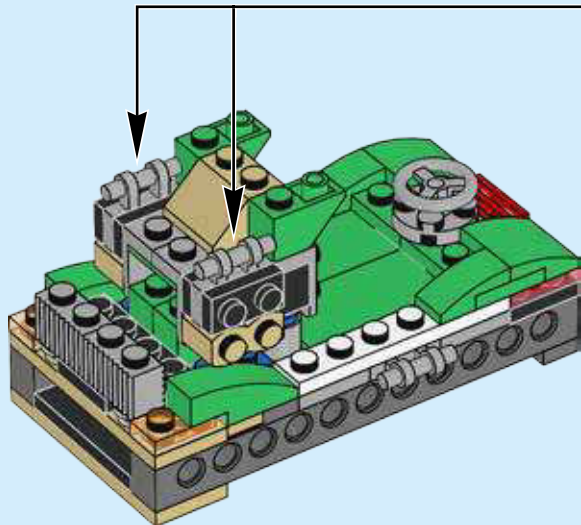



2x

22

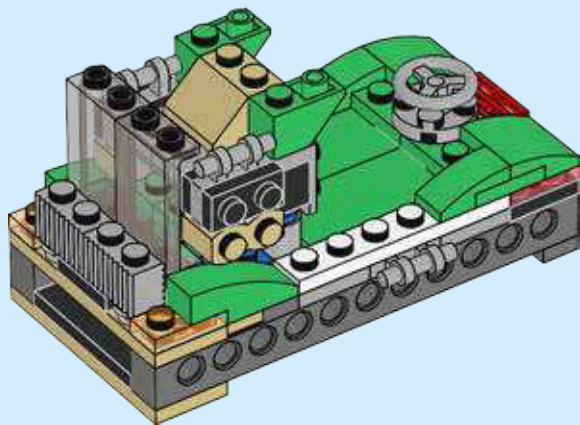



2x

23

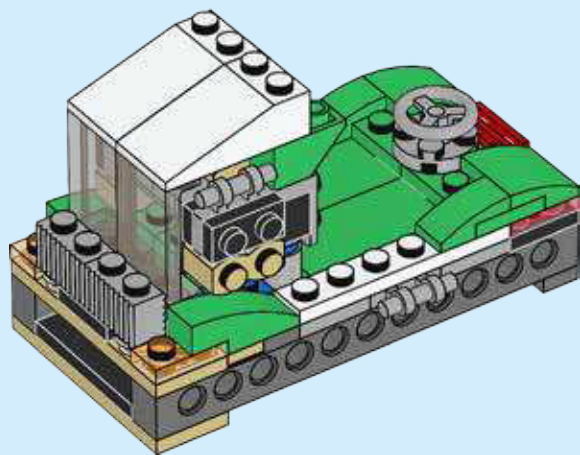



24

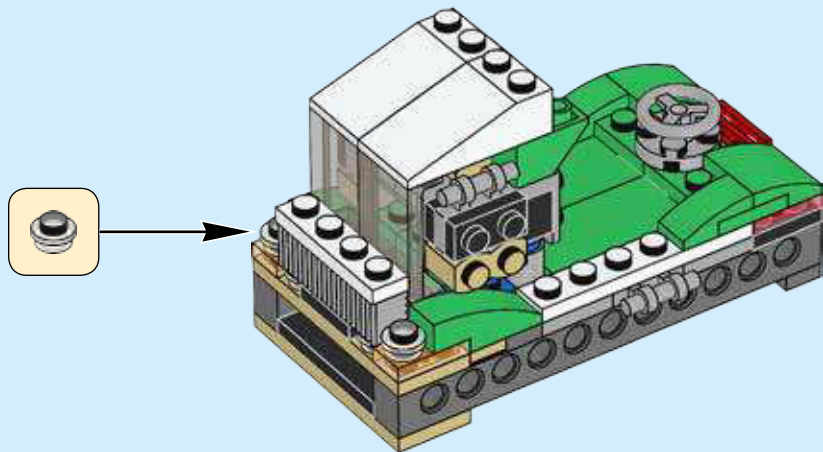



2x



2x

25

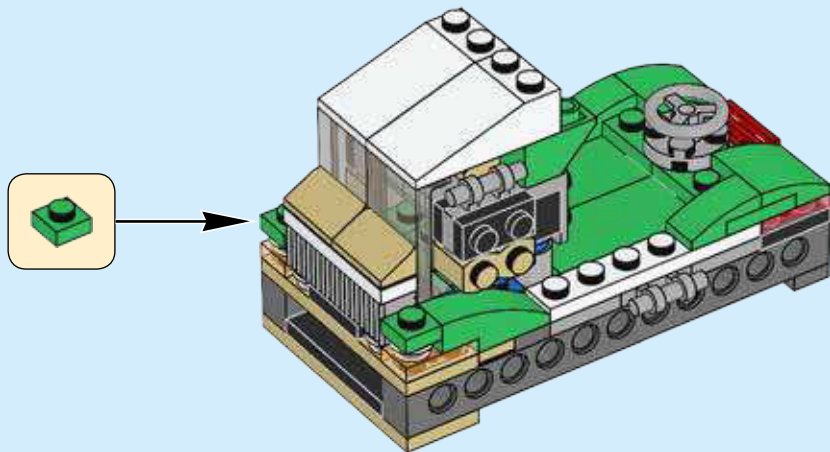



1x



2x

26

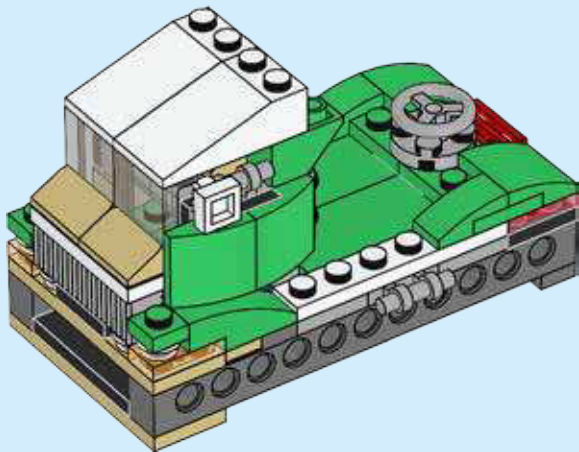



1x



2x

27

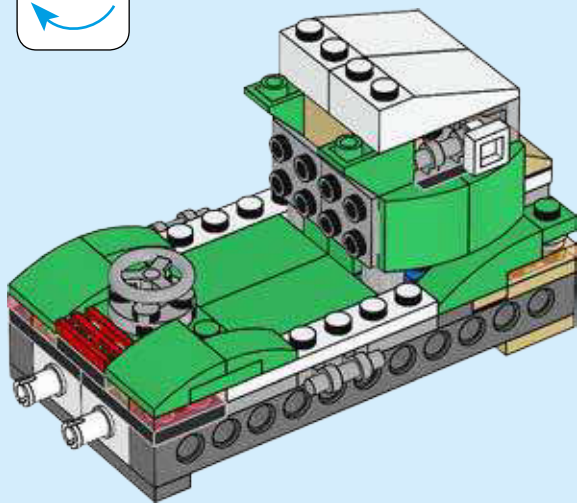
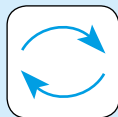



2x



1x

28

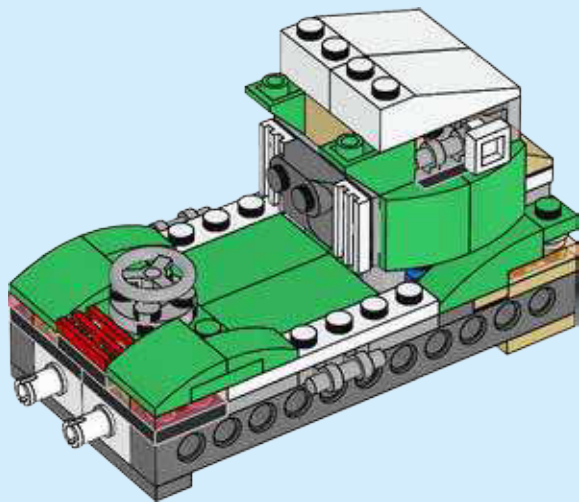



2x

29

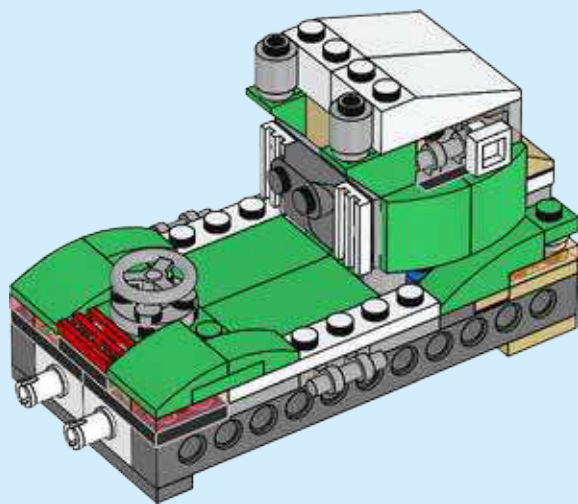

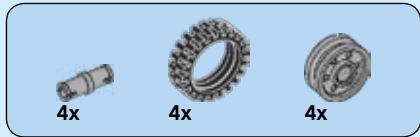

30

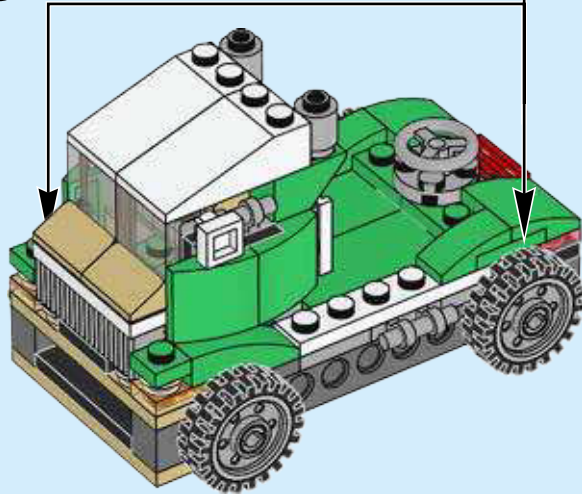
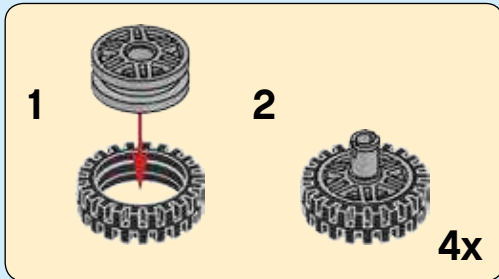
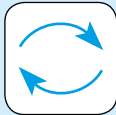

1x
4289538

6x
302326

2x
4225201

4x
4541455

4x
302126

1x
301026

1x
6092570

1x
303426

2x
302428

2x
6047426

4x
4142989

6x
6116259

2x
6039946

2x
4109679

2x
302128

2x
4566179

1x
346028

4x
4211412

1x
4211475

1x
6092956

4x
4211807

2x
4211383

5x
6117967

4x
6044729

4x
4211632

2x
4211452

2x
6054551

3x
241201

2x
4160228

2x
362201

1x
371001

2x
4143000

2x
366601

2x
4624086

2x
4218749

1x
4114322

1x
4157277

2x
4113993

4x
614123

2x
362323

2x
4218696

1x
4211064

2x
4211056

2x
4210963

2x
241221

2x
243124

4x
3005740

2x
4201019

2x
6010736

1x
6074885

4x
4280341

Customer Service

Kundenservice

Service Consommateurs

Servicio Al Consumidor

LEGO.com/service or dial



: 00800 5346 5555

: 1-800-422-5346

3 IN 1



LEGO and the LEGO logo are trademarks of the LEGO Group. ©2017 The LEGO Group.

6187064

LEGO.com/creator



CREATOR

31056

3^{IN}1

A small icon of a blue book with white pages, positioned below the "3^{IN}1" text.

LEGO.com/creator

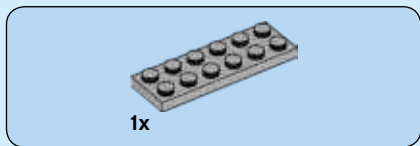
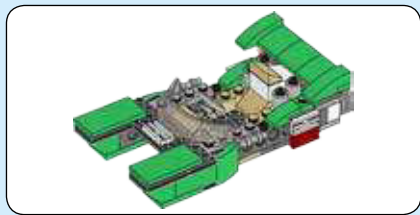

1

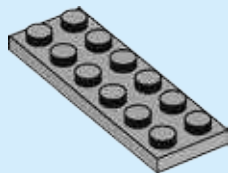

2

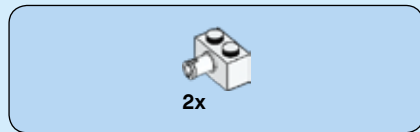

2

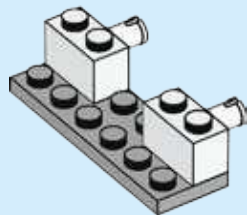

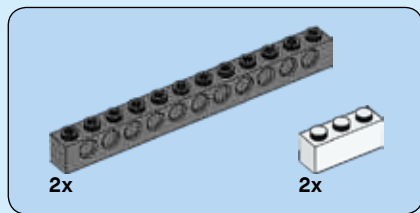

3

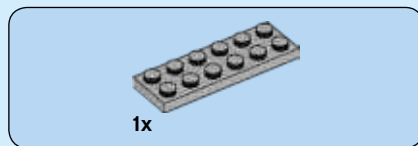
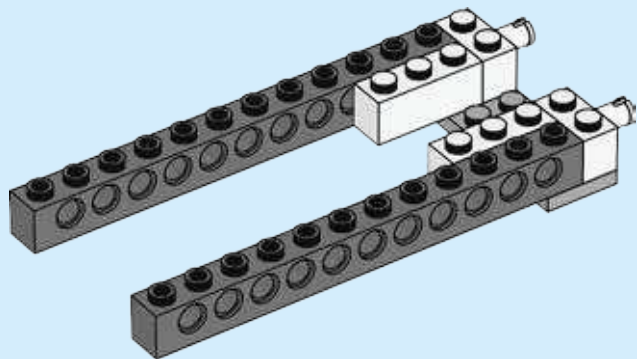

4

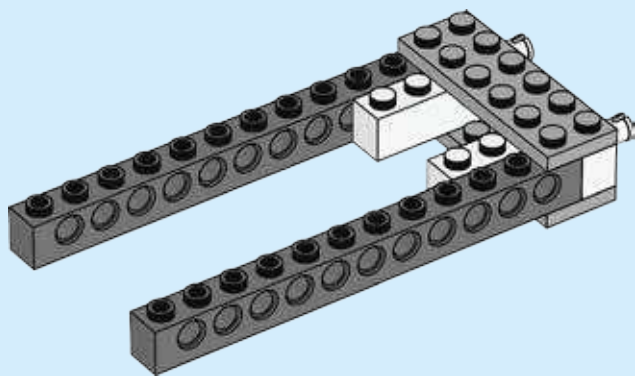

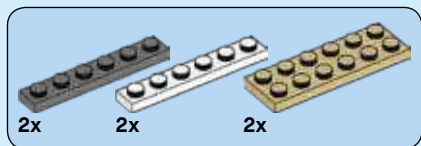

5

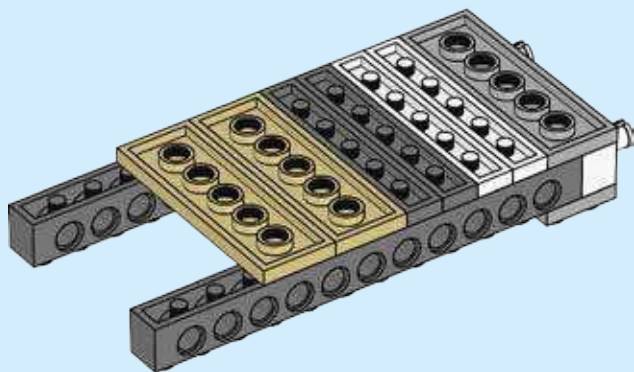
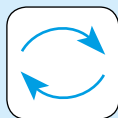



2x



2x

6

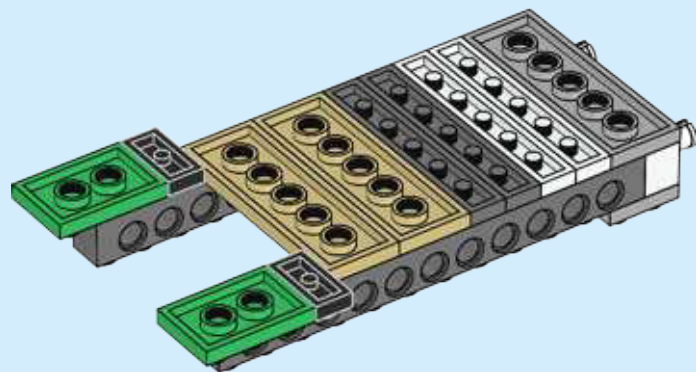

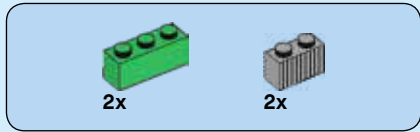

7

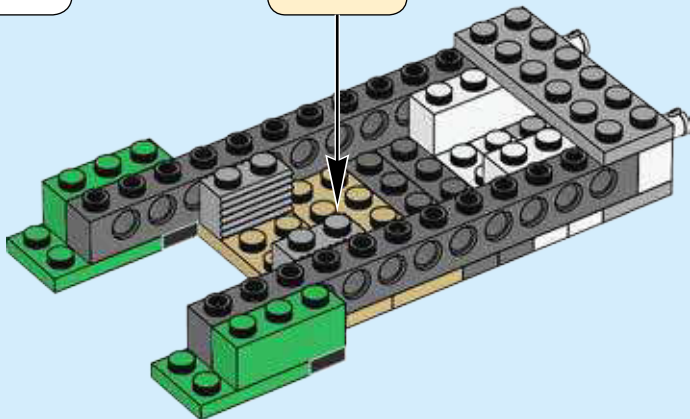
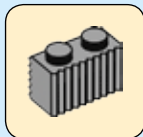
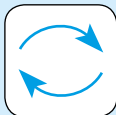



4x

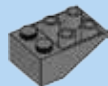

1x

8

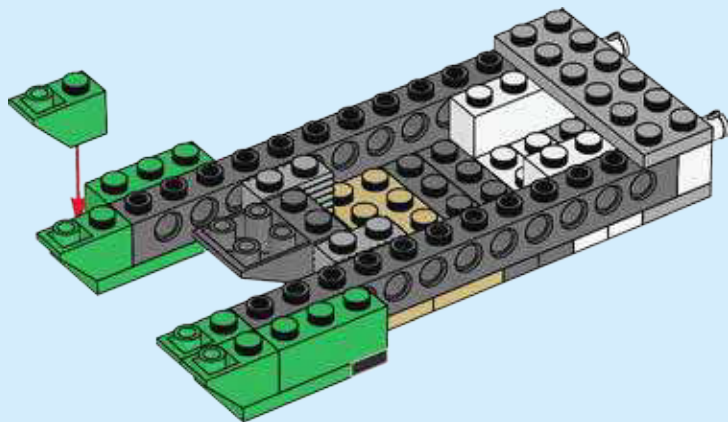

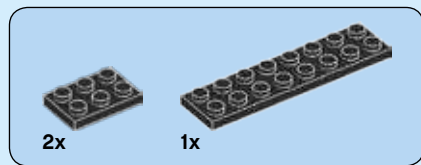

9

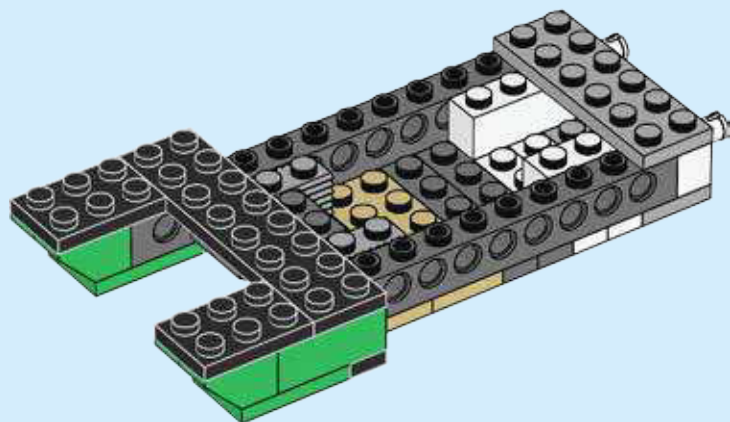

8



10

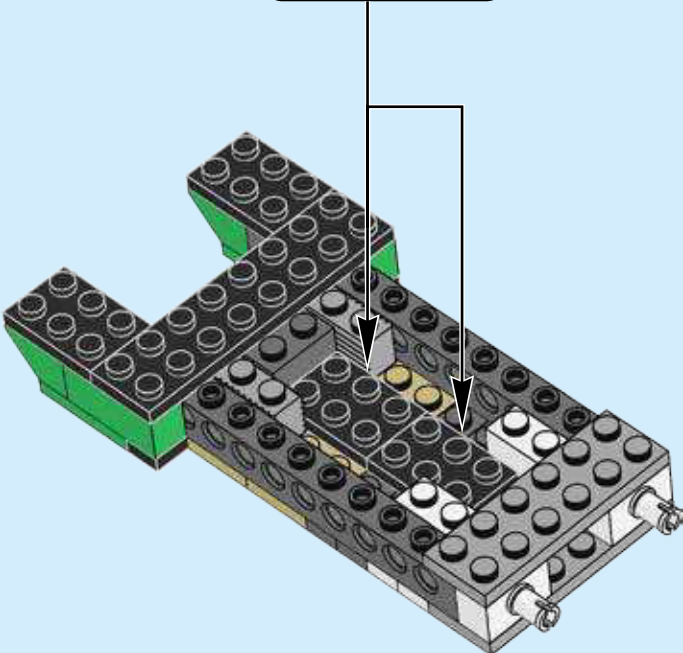



2x

11

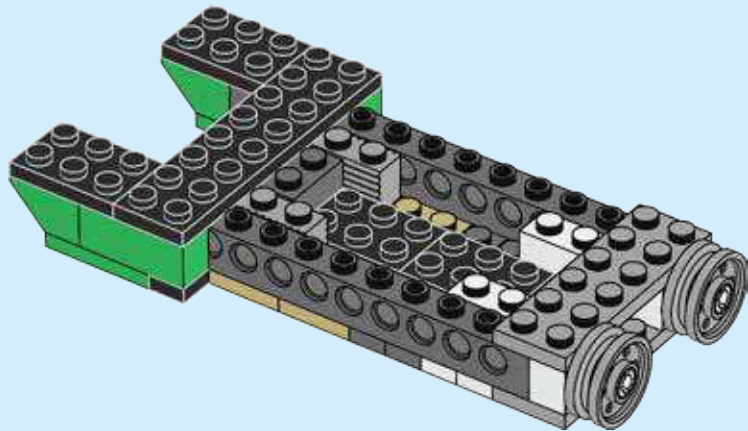



12

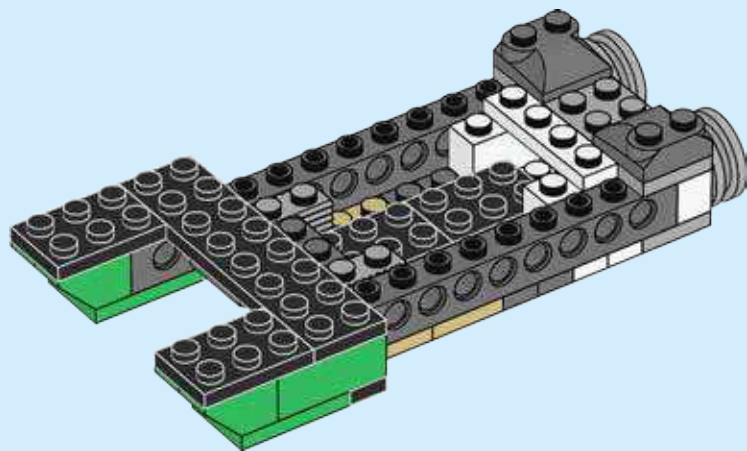



1x



2x

13

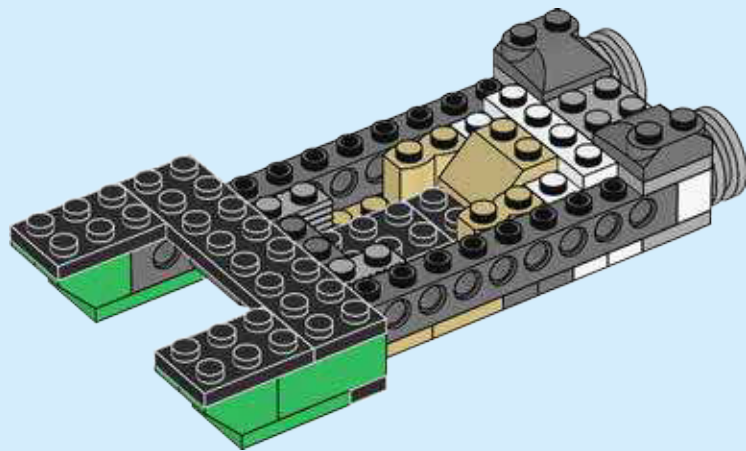



14

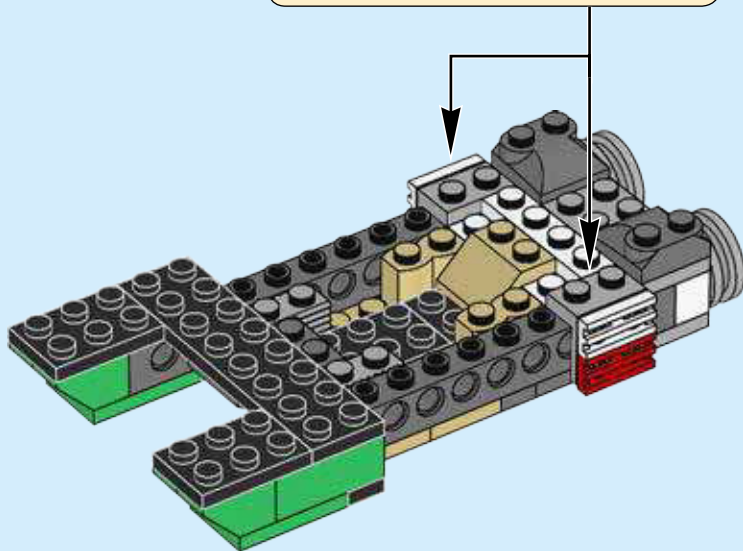
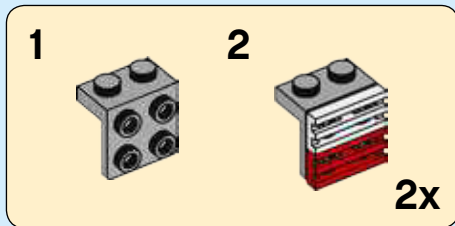



2x



2x

15

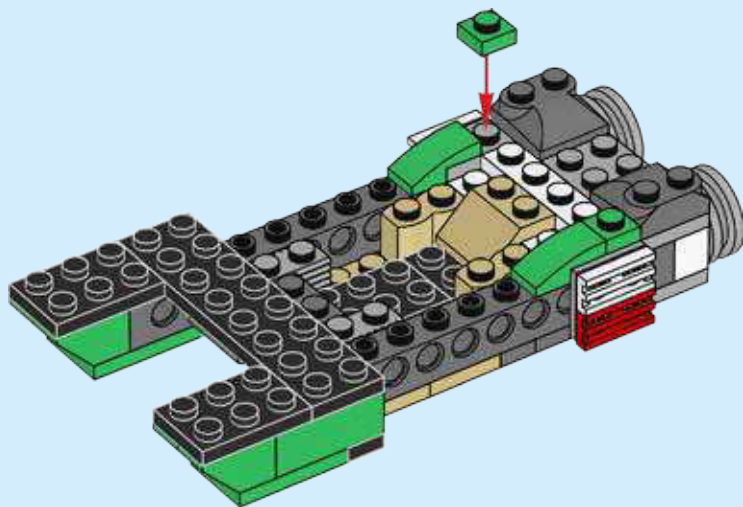



4x



2x

16

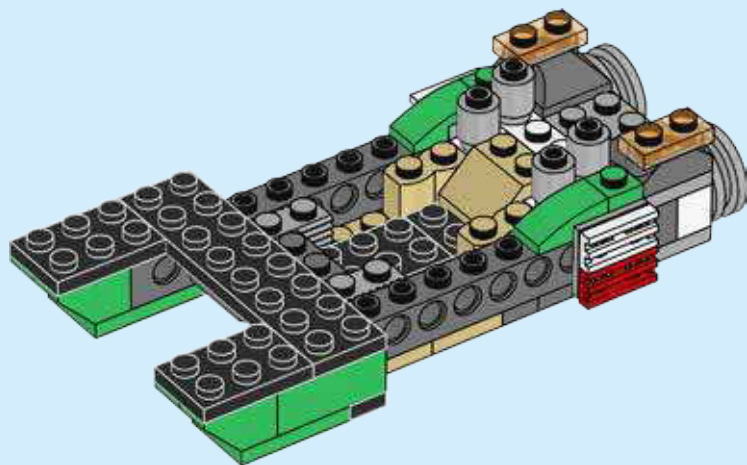



2x

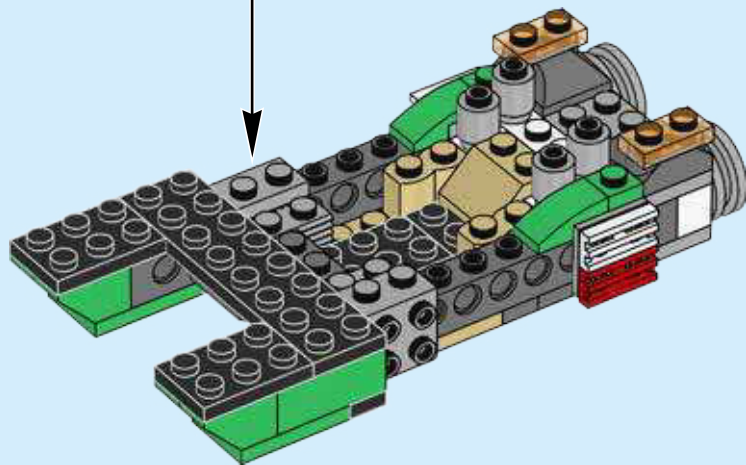

17

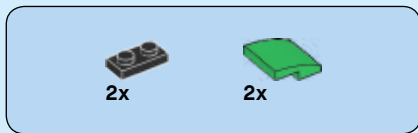

18

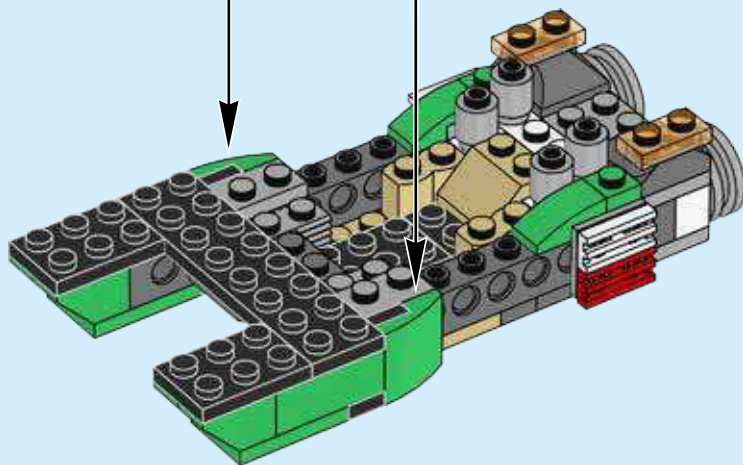



19

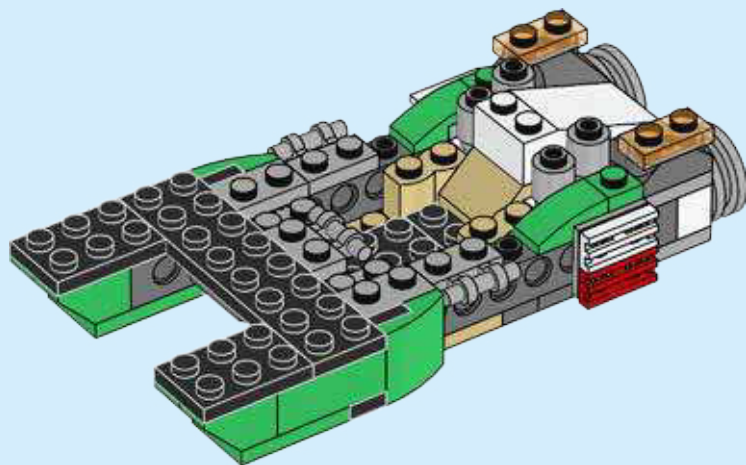



1x



1x

1



2



20

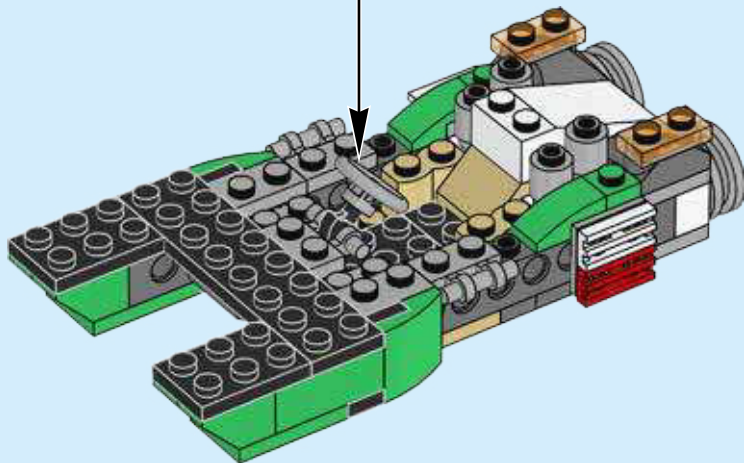



2x

21

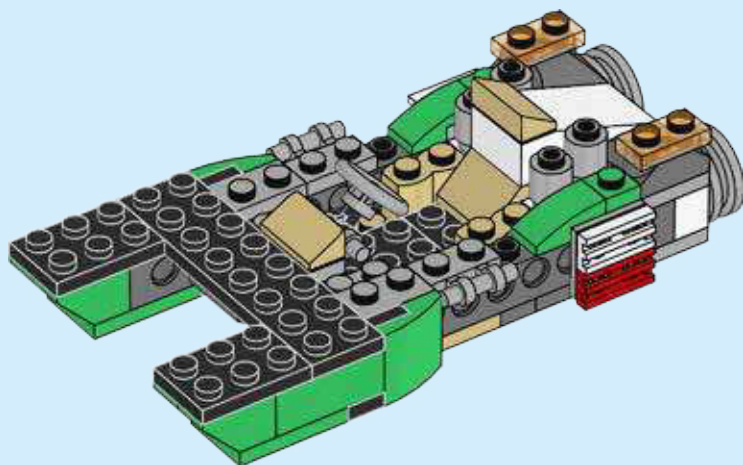

20

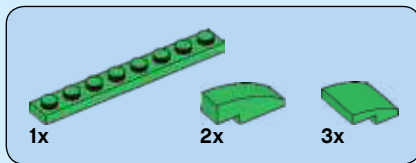

22

1

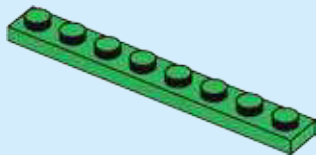

2

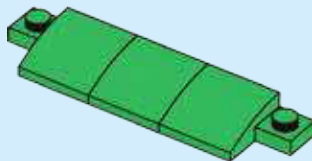

3

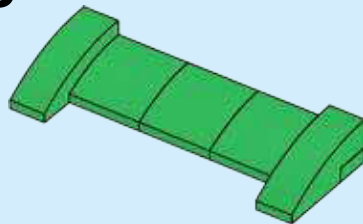

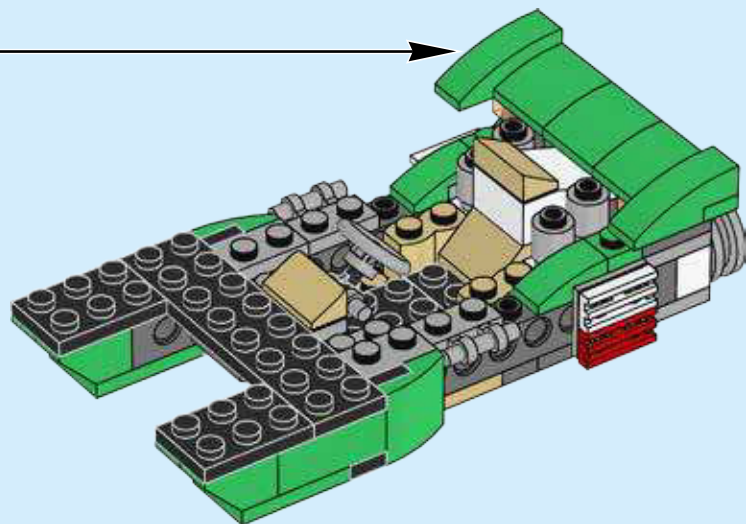

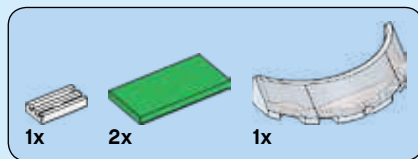

23

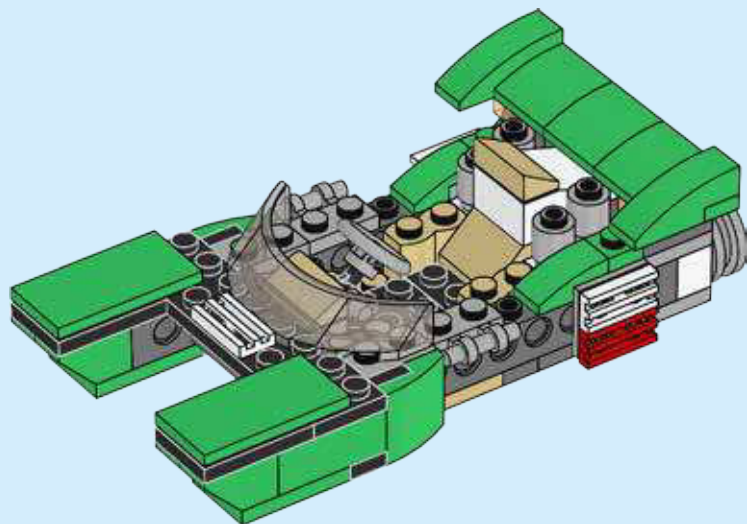



CREATOR



CREATOR ISLANDS



LEGO.com/creator

LEGO and the LEGO logo are trademarks of the LEGO Group. ©2017 The LEGO Group.

Apple and the Apple logo are trademarks of Apple Inc., registered in the U.S. and other countries. App Store is a service mark of Apple Inc.

Google Play is a trademark of Google Inc.

Ask parents' permission first.
Bitte frage erst deine Eltern um Erlaubnis.
Demande d'abord l'autorisation d'un parent.

Chiedere prima il permesso ai genitori.
Pide antes permiso a tus padres.
Pede primeiro permissão aos teus pais.



Először kérj engedélyt a szüleidtől!
先请求家长的许可。

6201547