

**LEGO**

**CREATOR**

**3<sup>IN</sup>1**

31069

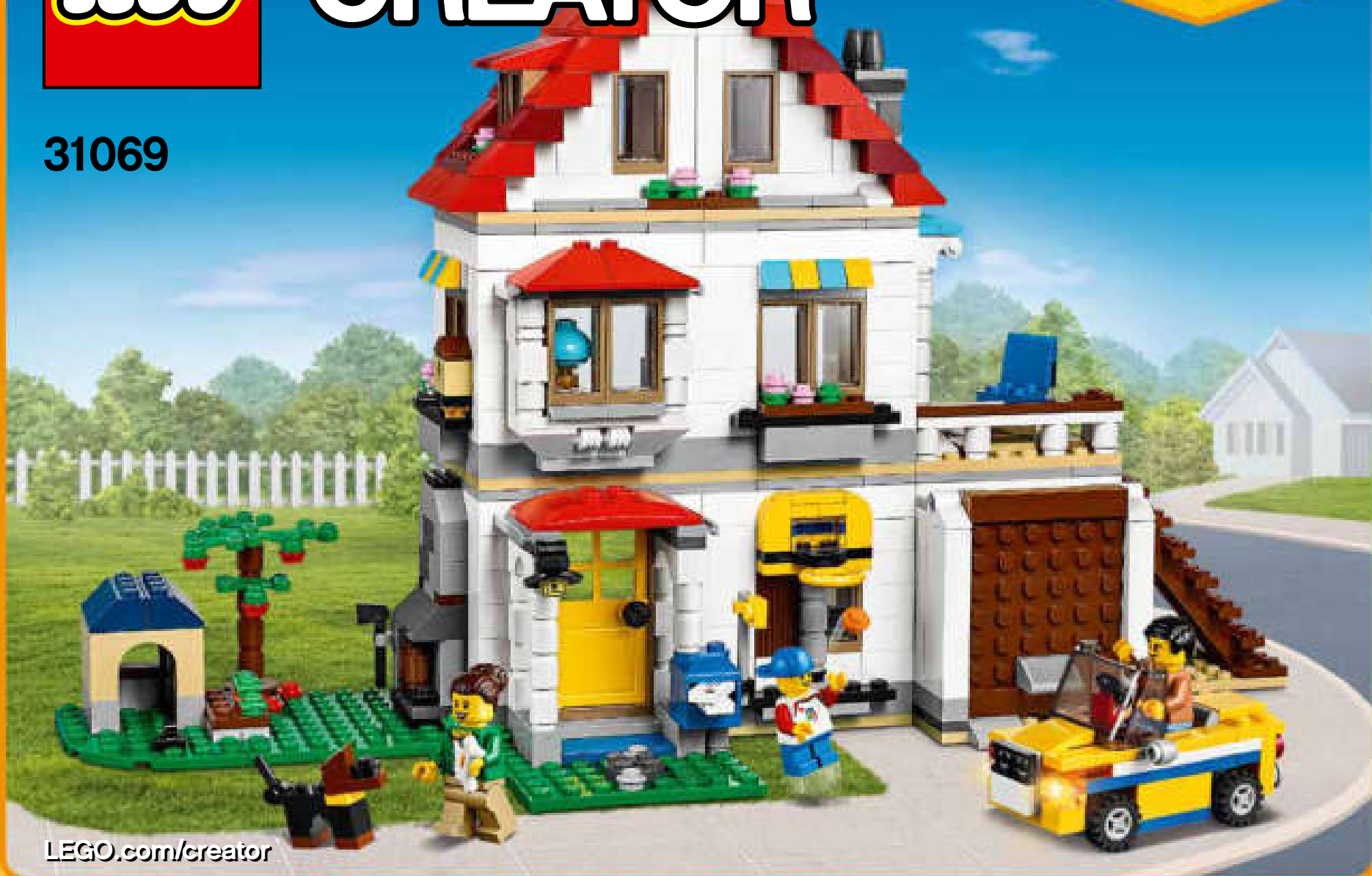

[LEGO.com/creator](http://LEGO.com/creator)

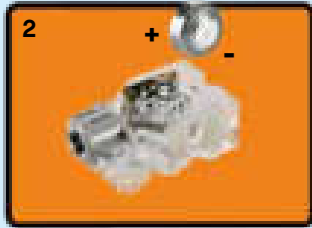
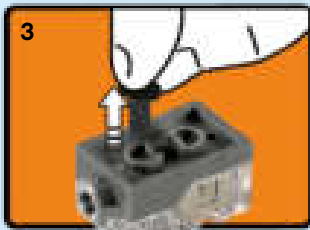

1:1  
2x  1.5V

**EN**  
Save this leaflet because it contains important information.

**Important information about batteries**  
Never use different types of batteries together, or a combination of old and new batteries. Always remove the batteries if the product is not to be used for a long time or if the batteries have run down. Never use damaged batteries. Only use batteries of the type recommended, or a corresponding type. Insert the batteries so that the poles are correctly positioned. Rechargeable batteries must be recharged using the correct battery charger under the supervision of an adult. You cannot recharge batteries while they are still in the product, and you must never try to do so. Never attempt to recharge non-rechargeable batteries. Never short-circuit the battery holder.

**IT**  
Salvare questo foglio perché contiene importanti informazioni.

**Importanti informazioni sulle batterie**  
Non usare mai contemporaneamente batterie di tipo diverso o batterie nuove e usate insieme. Rimuovere sempre le batterie qualora il prodotto non venga utilizzato per periodi prolungati, oppure se le batterie sono esauste. Non utilizzare mai batterie danneggiate. Usare esclusivamente batterie del tipo raccomandato o un equivalente. Inserire le batterie avendo cura che la loro polarità sia corretta. Le batterie ricaricabili vanno ricaricate in un caricabatterie di tipo idoneo e con la supervisione di un adulto. Non è possibile e non bisogna mai tentare di ricaricare le batterie mentre queste sono inserite nel prodotto. Non tentare mai di ricaricare batterie non ricaricabili. Non cortocircuitare mai il portabatterie.

**DA**  
**Vigtige oplysninger om batterier**  
Brug aldrig forskellige batterityper sammen eller en kombination af gamle og nye batterier. Fjern altid batterierne, hvis produktet ikke skal bruges i lang tid, eller hvis batterierne er flade. Brug aldrig beskadigede batterier. Brug kun den anbefalede type batterier eller en tilsvarende type. Sæt batterierne i, så polerne vender den rigtige vej. Genopladelige batterier skal oplades i den rigtige batterioplader. Batterierne skal sættes i opladeren under opsyn af en voksen. Batterierne kan ikke oplades, mens de stadig sidder i produktet, og man må aldrig forsøge at gøre det. Forsøg aldrig at oplade ikke-genopladelige batterier. Kortslut aldrig batteriholderen.

**DE**  
**Wichtige Informationen zu Batterien**  
Benutzen Sie niemals unterschiedlich Arten von Batterien oder alte und neue gleichzeitig. Nehmen Sie stets die Batterien heraus, wenn mit dem Modell längere Zeit nicht gespielt wird oder wenn die Batterien leer sind. Verwenden Sie niemals beschädigte Batterien. Verwenden Sie ausschließlich empfohlene bzw. geeignete Batterien. Achten Sie beim Einsetzen der Batterien auf die richtige Polung. Wiederaufladbare Batterien sollten mit einem geeigneten Ladegerät aufgeladen werden - unter der Aufsicht eines Erwachsenen. Wiederaufladbare Batterien können und sollten niemals aufgeladen werden, während sie sich im Modell befinden. Versuchen Sie unter keinen Umständen, „normale“ Batterien wieder aufzuladen. Schließen Sie das Batteriefach niemals kurz.

**NL**  
**Belangrijke informatie over batterijen**  
Gebruik nooit verschillende soorten of een combinatie van oude en nieuwe batterijen tegelijkertijd. Verwijder de batterijen altijd als je het product lange tijd niet wilt gebruiken of als batterijen leeg zijn. Gebruik nooit beschadigde batterijen. Gebruik uitsluitend batterijen van het aanbevolen type of een overeenkomstig type. Plaats de batterijen met de polen in de juiste richting. Opladbare batterijen moeten in een voor dit doel bestemde oplader en onder toezicht van een volwassene opnieuw worden opgeladen. Opladbare batterijen kunnen niet worden opgeladen terwijl ze zich nog in het product bevinden en dit mag ook nooit worden geprobeerd. Probeer nooit niet-opladbare batterijen opnieuw op te laden. Laat de batterijhouder nooit kortsluiten.

**IS**  
**Mikilvægar upplýsingar um rafhlöður**  
Aldrei skal nota mismunandi gerðir rafhlöðna samtímis, né nýjar og eldri rafhlöður samtímis. Ef ekki á að nota tæki á lengri tíma eða ef rafhlöðurnar eru orðnar tómar skal fjarlægja rafhlöðurnar. Aldrei skal nota rafhlöður sem hafa skemmt. Aðeins skal nota rafhlöður af þeirri gerð sem mælt er með, eða samsvarandi gerð. Setja skal rafhlöðurnar í þannig að ++ og -skaut þeirra snúi rétt. Endurhláðanlegar rafhlöður skal endurhláða með réttu hlöðslutæki undir eftirliti fullorðinna. Rafhlöður er ekki hægt að endurhláða á meðan þær eru enn í vörnni og það má aldrei reyna að gera það. Aldrei skal reyna að endurhláða rafhlöður sem ekki eru endurhláðan -legar. Aldrei ætti að valda skammhlaupi í rafhlöðuhólfinu.

**FR**  
**Informations importantes concernant les piles**  
Ne jamais utiliser un mélange de différents types de piles, ou de piles neuves et de piles anciennes ou déjà utilisées. Toujours retirer les piles si le produit n'est pas utilisé durant une période prolongée ou si les piles sont vides. Ne jamais utiliser de piles endommagées. Utiliser uniquement des piles du type recommandé ou d'un type équivalent. En insérant les piles, respecter scrupuleusement le sens d'orientation des pôles (+/-). Les piles rechargeables doivent être rechargées en utilisant un chargeur de piles adéquat et sous la surveillance d'un adulte. Il est impossible de recharger les piles quand elles sont installées dans le produit. Ne jamais tenter de le faire. Ne jamais essayer de recharger des piles non-rechargeables. Ne jamais court-circuiter le compartiment des piles.

**ES**  
**Información importante acerca de las pilas**  
No use pilas de diferentes tipos ni pilas nuevas y antiguas para alimentar el producto. Extraiga las pilas del producto si este va a permanecer sin uso durante un período prolongado de tiempo o aquellas se han agotado. No use pilas dañadas. Use sólo pilas del tipo recomendado u otro equivalente. Inserte las pilas de modo que los polos queden situados en las posiciones correctas. La carga de pilas recargables debe tener lugar empleando un cargador apropiado y bajo la supervisión de un adulto. Las pilas recargables no se pueden cargar mientras permanecen insertadas en el producto; no intente hacerlo. No trate de cargar pilas no recargables. No cortocircuite el compartimento de las pilas.

**FI**  
**Tärkeää tietoa paristoista**  
Älä koskaan käytä erityyppisiä paristoja yhdessä. Älä myöskään käytä samassa laitteessa sekä vanhoja että uusia paristoja. Poista paristot tuotteesta aina, kun se on pitemmän aikaa käyttämättä, tai kun paristot ovat tyhjentyneet. Älä koskaan käytä viallisia paristoja. Käytä vain tuotteesta suositeltuja tai vastaaventyyppisiä paristoja. Aseta paristot siten, että navat osoittavat oikeaan suuntaan. Ladattavat paristot on ladattava oikeanlaisella laturilla aikuisen valvonnassa. Ne on poistettava tuotteesta lataamisen ajaksi. Älä koskaan yritä ladata paristoja, joita ei ole tarkoitettu ladattaviksi. Älä koskaan aiheuta oikosulkua pariston kosketintien välillä.

## SV

### Viktig information om batterier

Använd aldrig olika sorters batterier samtidigt, och inte heller en kombination av gamla och nya batterier. Ta alltid ur batterierna om produkten inte ska användas under en längre tid eller om batterierna är sluta. Använd aldrig skadade batterier. Använd bara batterier av den typ som rekommenderas, eller av en motsvarande typ. Sätt i batterierna så att polerna hamnar i rätt läge. Laddningsbara batterier måste laddas med rätt slags batteriladdare och under en vuxens överinseende. Du kan inte ladda batterierna medan de fortfarande sitter i produkten, och du får heller aldrig försöka göra det. Försök aldrig ladda icke laddningsbara batterier. Kortslut aldrig batteriutrymmets kontaktytor.

## NO

### Viktig informasjon om batterier

Bruk aldri ulike typer batterier sammen og heller aldri gamle og nye batterier sammen. Ta alltid ut batteriene hvis produktet ikke skal brukes på lang tid, eller hvis batteriene er brukt opp. Bruk aldri skadde batterier. Bruk kun anbefalt type batterier eller tilsvarende type. Sett inn batteriene med polene vendt riktig vei. Oppladbare batterier skal lades opp med riktig batterilader, under overoppsyn av en voksen. Det er ikke mulig å lade opp batteriene mens de fremdeles er i produktet, og du må aldri forsøke å gjøre det. Forsøk aldri å lade opp ikke-oppladbare batterier. Kortslett aldri batteriholderen.

## PT

### Guardar este folheto por conter informações importantes.

**Informação importante sobre as pilhas**  
Nunca use diferentes tipos de pilhas em simultâneo, ou uma combinação de pilhas usadas e novas. Retire sempre as pilhas se o produto não for usado durante muito tempo ou se as pilhas já não tiverem carga. Nunca use pilhas danificadas. Use apenas pilhas do tipo recomendado ou de um tipo correspondente. Insira as pilhas de forma a que os pólos fiquem corretamente posicionados. As pilhas recarregáveis devem ser recarregadas com o carregador de pilhas correto e sob a supervisão de um adulto. Não pode recarregar as pilhas enquanto as mesmas se encontram colocadas no produto e nunca deve tentar colá-las. Nunca tente recarregar pilhas não recarregáveis. Nunca deixe o compartimento das pilhas entrar em curto-circuito.

## EL

**Σημαντικές πληροφορίες για τις μπαταρίες**  
Μην χρησιμοποιείτε ποτέ διαφορετικούς τύπους μπαταριών μαζί και μην συνδυάζετε παλιές και καινούργιες μπαταρίες. Αφαιρείτε πάντα τις μπαταρίες αν δεν σκοπεύετε να χρησιμοποιήσετε το προϊόν για αρκετό καιρό ή αν οι μπαταρίες έχουν αδειάσει. Ποτέ μην χρησιμοποιείτε μπαταρίες που έχουν φθορές. Χρησιμοποιείτε μόνο μπαταρίες του συστήματός σας ή κάποιου αντίστοιχου τύπου. Τοποθετήστε τις μπαταρίες με τους πόλους στη σωστή θέση. Οι επαναφορτιζόμενες μπαταρίες πρέπει να επαναφορτίζονται χρησιμοποιώντας το σωστό φορτιστή μπαταριών υπό την επίβλεψη ενηλίκου. Δεν μπορείτε να επαναφορτίσετε τις μπαταρίες όταν αυτές βρίσκονται μέσα στο προϊόν και δεν πρέπει ποτέ να δοκιμάσετε κάτι τέτοιο. Μην επιχειρήσετε ποτέ να επαναφορτίσετε μη επαναφορτιζόμενες μπαταρίες. Ποτέ μην βραχυκυκλώνετε τη θήκη των μπαταριών.

## JA

### 電池取扱に関する重要事項

異なるタイプの電池や古い電池を混ぜて使用しないでください。商品を長時間使用しないときや電池が切れたときは、電池を必ず取り外してください。不具合のある電池は絶対に使用しないでください。推奨されているタイプまたは対応しているタイプの電池を必ず使用してください。電極を確認して電池を正しい向きに入れてください。充電式電池は、保護者に見てもらった上で適切な充電器を使って充電してください。電池を商品の中にいれたまま充電することは絶対に避けてください。充電式ではない電池は絶対に充電しないでください。電池ホルダをショートさせないでください。

## ZH

### 该包装含重要信息应保留。

### 关于电池的重要信息

请勿同时使用不同类型的电池，或把新旧程度不同的电池混合使用。如果产品将有很长时间不会使用，或者电池已经没电，请注意取出电池。切勿使用已破损的电池。务必仅使用推荐类型或兼容类型的电池。装入电池时请注意正负极。如果使用充电电池，务必在成人监护下使用正确的电池充电器进行充电。电池仍在产品中时不可进行充电，请勿强行尝试充电。请勿尝试给非充电电池充电。切勿对电池仓进行短路连接。

## KO

### 배터리 사용 시 주의사항

다른 종류의 배터리를 함께 사용하지거나, 새 전지와 오래된 전지를 혼용하지 마세요. 배터리가 방전되었거나 장기간 제품을 작동하지 않을 때에는 반드시 배터리를 분리하세요. 파손된 배터리는 사용하지 마세요. 레고에서 권장하는 유형의 배터리만 사용하세요. 양극과 음극의 위치를 잘 맞춰서 넣으세요. 어른의 감독에 따라 지정된 충전기에 충전지를 충전해야 합니다. 충전지를 제품에 넣은 상태로 충전하면 안 됩니다. 일반 배터리는 충전해서 사용할 수 없습니다. 배터리 홀더의 접촉부에 배터리를 정확히 끼워서 사용하세요.

## RU

### Необходимая информация об элементах питания

Ни в коем случае не используйте одновременно элементы питания различных типов, а также элементы питания с разным сроком годности. В обязательном порядке вынимайте элементы питания из терминалов в случае, если вы не пользуетесь прибором в течение долгого времени, либо в случае, если в элементах питания закончился заряд. Ни в коем случае не используйте поврежденные элементы питания. Используйте только рекомендуемые элементы питания либо элементы питания соответствующего типа. Установите элементы питания, соблюдая указанную полярность. Аккумуляторные элементы питания должны подзаряжаться в соответствующем зарядном устройстве под наблюдением взрослого. Ни в коем случае не пытайтесь подзаряжать элементы питания, находящиеся в приборе. Ни в коем случае не пытайтесь подзаряжать неперезаряжаемые элементы питания. Ни в коем случае не пытайтесь замкнуть полюса в устройстве для элементов питания.

## PL

### Ważne informacje dotyczące baterii

Nigdy nie należy stosować razem różnych rodzajów baterii ani stosować równocześnie starych i nowych baterii. Jeżeli produkt nie jest używany przez dłuższy czas lub jeżeli baterie się wyczerpały, należy wyjąć baterie. Nigdy nie należy stosować uszkodzonych baterii. Należy stosować wyłącznie zalecany rodzaj baterii lub rodzaj mu odpowiadający. Przy wkładaniu baterii należy zwrócić uwagę na właściwe położenie biegunów. Baterie akumulatorowe należy ładować w odpowiedniej ładowarce pod nadzorem osoby dorosłej. Nie można naładować baterii bez wyjęcia ich z produktu i nigdy nie należy tego próbować. Nigdy nie należy próbować ładowania baterii jednorazowych. Nigdy nie należy doprowadzać do zwarcia w gnieździe baterii.

## CZ

### Důležitá informace o bateriích

Nikdy nepoužívejte najednou různé typy baterií nebo kombinaci starých a nových baterií. Nebude-li se výrobek delší dobu používat nebo jsou-li baterie vybité, vždy je vyjměte z výrobku. Nikdy nepoužívejte poškozené baterie. Používejte pouze doporučené nebo odpovídající typy baterií. Baterie instalujte se správnou orientací pólů. Nabíjitelné baterie musí být nabitý ve vhodné nabíječe pod dohledem dospělé osoby. Nabíjitelné baterie nelze nabíjet, jsou-li umístěny ve výrobku, a nesmíte se o to ani pokoušet. Nikdy se nesnažte nabíjet baterie, které nejsou nabíjitelné. Nikdy nezkratujte kontakty v prostoru pro baterie.

## SK

### Dôležitá informácia o batériách

Nikdy nepoužívajte naraz odlišné typy batérií ani nekombinujte staré batérie s novými. Batérie vždy vyberte, ak sa výrobok nebude dlhšie používať, alebo ak sa batérie vybili. Nikdy nepoužívajte poškodené batérie. Používajte jen odporúčané alebo zodpovedajúce typy batérií. Batérie vkladajte so správnou orientáciou pólou. Nabíjateľné batérie sa musia nabíjať vo vhodnej nabíjačke pod dozorom dospelé osoby. Nabíjateľné batérie sa nesmú nabíjať, ak sú umiestnené vo výrobku, a nesmiete sa o to ani pokúšať. Nikdy sa nesnažte nabíjať batérie, ktoré nie sú nabíjateľné. Nikdy neskratujte kontakty v priestore pre batérie.

## HU

### Fontos tudnivalók az elemekről

Soha ne használjon különböző típusú elemeket, illetve ne használjon vegyesen új és használt elemeket. Mindig távolítsa el az elemeket, ha a készüléket előre láthatóan hosszabb ideig nem fogják használni, vagy ha az elemek lemerültek. Soha ne használjon megromlódott elemeket. Csak az ajánlott típusú, vagy annak megfelelő elemet használjon. Az elemeket helyesen helyezze be, a polaritásuknak megfelelően. Az akkumulátorokat csak a megfelelő akkumulátor-töltővel szabad feltölteni, felnettől felügyelete mellett. Az akkumulátorokat nem lehet feltölteni, ha azok a készülékben vannak. Ezt meg sem szabad próbálni. Soha ne próbálja meg feltölteni a nem tölthető elemeket. Soha ne hozzon létre rövidzárlatot az elemtartó kivezetésén.

## UA

### Необхідна інформація про батареї

Ніколи не використовуйте одночасно батареї різних типів або батареї з різним терміном придатності. Обов'язково вилучайте батареї з приладу, якщо довіго не користуетесь ним, або якщо в батареїках вже скінчився заряд. Ніколи не використовуйте пошкоджені батареї. Використовуйте батареї лише рекомендованого або відповідного типу. Вставляйте батареї, враховуючи задану полярність. Акумуляторні батареї повинні заряджатися у відповідному зарядному приладі під наглядом дорослого. В будь-якому випадку не намагайтеся підзарядити батареї, що знаходяться в приладі. В будь-якому випадку не намагайтеся підзарядити батареї, що не підлягають підзарядці. В будь-якому випадку не намагайтеся зробити коротке замикання в приладі для батарей.

## HR

### Važne obavijesti o bateriji

Nikada nemoj koristiti različite vrste baterija zajedno, isto tako ni kombinaciju starih i novih baterija. Uvijek izvadi baterije ako dugo nećeš koristiti proizvod ili ako su one potrošene. Nikada nemoj koristiti oštećene baterije. Koristi samo preporučenu vrstu ili odgovarajuću vrstu baterija. Umetni baterije pažeci da dobro okreneš polove. Akumulatorske se baterije moraju puniti uz pomoć propisanog punjača i uz nadzor odrasle osobe. Baterije se ne smiju puniti dok su još u proizvodu i to nikada nemoj pokušavati. Nikada ne pokušavaj puniti baterije koje nisu predviđene za punjenje. Nikada ne izlazivaj kratki spoj u držaču baterija.

## SR

### Важне информације о батеријама

Никада не користите различите типове батерија заједно нити комбинацију старих и нових батерија. Увек извадите батерије уколико производ нећете дуже време користити или уколико су батерије празне. Никада не користите оштећене батерије. Употребљавајте само препоручени тип батерија или одговарајућу замену. Ставите батерије тако да су полови правилно позиционисани. Батерије на пуњење се морају пунити одговарајућим пуњачем под надзором одраслог лица. Није могуће пунити батерије док су у производу и никад не покушавајте да радите то. Никада не покушавајте да пуните батерије које не могу да се пуне. Никада не издвајајте кратак спој у кућишту за батерије.

## MK

### Важни информации за батериите

Никогаш не користете различити типови батерији заедно или комбинација од стари и нови батерији. Секогаш отстранувајте ги батериите доколку не го користите производот додолго време или доколку се потрошиле. Никогаш не користете оштетени батерији. Користете ги само препорачаните батерији или батерији од соодветен тип. Вметнете ги батериите така што точно ќе ги наместите половите. Батериите на полнење мора да се полнат со соодветниот полнач под надзор на возрастна лице. Не може да ги полните батериите додека сè уште се наоѓаат во производот и никогаш не смеете да го правите тоа. Никогаш не обидувајте се да ги полните батериите за еднократна употреба. Никогаш не предизвикувајте краток спој на држачот за батерији.

## SL

### Pomembne informacije o baterijah

Nikoli ne uporabljajte skupaj različnih baterij ali kombinacije starih in novih baterij. Vedno odstranite baterije, če izdelka dlje časa ne boste uporabljali ali če so iztrošene. Nikoli ne uporabljajte poškodovanih baterij. Uporabljajte le baterije priporočene ali ustreznega tipa. Baterije vstavite tako, da so njihovi poli pravilno obrnjeni. Akumulatorske baterije je treba polniti s pravim polnilnikom pod nadzorom odrasle osebe. Akumulatorskih baterij ni mogoče polniti, dokler so še v izdelku. Tega tudi ne smete poskušati. Nikoli ne poskušajte polniti baterij, ki niso akumulatorske. Pazite, da ležišč za baterije ne boste spravili v kratek stik.

## RO

### Informații importante despre baterii

Nu folosiți niciodată împreună tipuri diferite de baterii, sau o combinație de baterii vechi și noi. Îndepărtați întotdeauna bateriile dacă produsul nu este folosit timp îndelungat sau dacă bateriile s-au epuizat. Nu folosiți niciodată baterii deteriorate. Folosiți numai baterii de tipul recomandat, sau un tip corespunzător. Introduceți bateriile astfel ca polii să fie poziționați corect. Bateriile reincărcabile trebuie reincărcate utilizând încărcătorul corect sub supravegherea unui adult. Nu puteți reincărca bateriile în timp ce acestea sunt încă în produs, și niciodată nu trebuie să încercați să faceți acest lucru. Nu încercați niciodată să reincărcați baterii nereîncărcabile. Nu scurtcircuitați niciodată suportul bateriei.

## BG

### Важна информация за батериите

Никога не използвайте едновременно различни типове батерији или комбинација от стари и нови батерији. Винаги изваждајте батериите, ако издेलието няма да се използва продолжително време или ако батериите са се източили. Никога не използвайте повредени батерији. Използвайте само батерији от препоръчвания тип или съответстващ на него тип. Поставете батериите така, че полюсите да са разположени правилно. Акумулаторните батерији трябва да се зареждат с подходящо зареждащо устройство под надзора на възрастни. Батериите не могат да се зареждат, докато са поставени в изделието, затова никога не опитвайте да правите това. Никога не опитвайте да зареждате батерији, които не са акумулаторни. Никога не свързвайте на късо контактите на отделението за батериите.

## LV

### Svarīga informācija par baterijām

Nekad vienlaikus nelietojiet dažādu tipu, kā arī vecas un jaunas baterijas. Vienmēr izņemiet baterijas, ja tās ir izlādējās vai ja produkts ilgāku laiku netiek lietots. Nekad nelietojiet bojātas baterijas. Lietojiet tikai ieteicamā tipa vai atbilstoša tipa baterijas. Ievietojot baterijas, ievērojiet pareizu polaritāti. Uzlādējamu bateriju lādēšanai izmantojiet atbilstošu bateriju lādētāju; uzlāde jāveic pieaugušo uzraudzībā. Baterijas nevar uzlādēt un nekad nedrīkst mēģināt uzlādēt, kamēr tās ievietotas produktā. Nekad nemēģiniet uzlādēt baterijas, kas nav uzlādējamās. Nepieļaujiet īssavienojumu bateriju nodalījumā.

## ET

### Oluline teave patareide kohta

Ära kunagi kasuta koos erinevat tüüpi patareisid, samuti vanu ja uusi patareisid. Kui mänguasja ei kasutata pika aja jooksul, võta patarei sellest välja. Ära kunagi kasuta kahjustatud patareisid. Kasuta ainult ettenähtud tüüpi või nendega samaväärsed patareisid. Pane patarei mänguasja sisse nii, et pluss- ja miinusklemmi asend oleks õige. Akusid tuleb laadida ainult neile ettenähtud akulaadija abil täiskasvanu järelevalve all. Akusid ei saa laadida sel ajal, kui need on mänguasja sees. Ära kunagi püüa nii teha. Ära kunagi proovi akulaadijaga laadida tavalisi patareisid. Patareipesa klemmide vahel ei tohi tekkida lühisid.

## LT

### Svarbi informacija apie elementus

Vienu metu nenaudokite skirtingų elementų, taip pat su naujais elementais nenaudokite senų. Jei nenaudosite gaminio ilgesnį laiką arba jei elementai išsekę, visumet išimkite juos iš gaminio. Niekada nenaudokite pažeistų elementų. Naudokite tik rekomenduojamo arba atitinkamo tipo elementus. Elementus dėkite atsižvelgdami į jų poliškumą. Elementus galima įkrauti tik tinkamu krovikliu ir prižiūrint saugusiesiems. Jokiu būdu negalima, ir niekuomet nebandykite, įkrauti elementų neišėjus jų iš gaminio. Niekada nebandykite įkrauti vienkartinių elementų. Saugokitės, kad elementų įdėkle nesukeltumėte trumpojo jungimo.

## TR

### Piller hakkında önemli bilgiler

Hiçbir zaman farklı tipte pilleri ya da eski pillerle yeni pilleri bir arada kullanmayın. Ürün uzun süre kullanılmayacaksa ya da piller bitmişse, pilleri ürünün içinden çıkarm. Hiçbir zaman zedelenmiş piller kullanmayın. Sadece önerilen tipte piller ya da bunların dengi olan piller kullanın. Pilleri kutupları doğru konumda olacak şekilde yerleştirin. Şarj edilebilen pilleri doğru pil şarj aletini kullanarak, bir yetiştikinin denetiminde şarj edin. Şarj edilebilen pilleri, pil ürünün içindeyken şarj edemezsiniz bunu hiçbir zaman yapmaya çalışmayın. Hiçbir zaman, şarj edilebilen olmayan pilleri şarj etmeye çalışmayın. Hiçbir zaman pil kutusuna kısa devre yaptırmayın.

## AR

### معلومات مهمة عن البطاريات

يُحظَر استخدام أنواع مختلفة من البطاريات معاً أو مزيج من البطاريات القديمة والجديدة. احرص دائماً على نزع البطاريات في حال عدم استخدام المنتج لفترة طويلة أو إذا نفذت طاقة البطاريات. تجنب استخدام البطاريات التالفة. لا تستخدم إلا نوع البطاريات الموصى به أو نوع متماثل. قم بتركيب البطاريات بحيث تكون الأقطاب في موضعها الصحيح. يجب إعادة شحن البطاريات القابلة لإعادة الشحن باستخدام شاحن البطاريات المناسب وذلك تحت إشراف شخص بالغ. لا يمكنك إعادة شحن البطاريات وهي لا تزال داخل المنتج. ويجب ألا تجرب فعل ذلك. يُحظَر إعادة شحن البطاريات غير القابلة لإعادة الشحن. تجنب إحداث دائرة قصر في حامل البطارية.

## ID

### Informasi penting tentang baterai

Jangan gunakan baterai yang jenisnya berlainan, atau mencampur baterai lama dan baterai baru. Lepas baterai jika produk tidak akan digunakan untuk waktu lama atau jika baterai sudah lemah. Jangan gunakan baterai yang rusak. Gunakan jenis baterai yang dianjurkan atau yang sejenis. Masukkan baterai dengan posisi kutub yang tepat. Baterai isi ulang harus diisi ulang dengan charger baterai yang sesuai dan di bawah pengawasan orang dewasa. Anda tidak dapat mengisi ulang baterai saat masih terpasang di dalam produk, dan jangan pernah coba melakukannya. Jangan pernah coba mengisi ulang baterai biasa. Jangan pernah membuat arus pendek pada dudukan baterai.

## MS

### Maklumat penting tentang bateri

Jangan guna jenis bateri yang berbeza bersama-sama, atau gabungan bateri baharu dan lama. Tanggalkan bateri jika produk tidak akan digunakan untuk tempoh masa yang lama atau jika bateri telah kehabisan kuasa. Jangan guna bateri yang rosak. Hanya guna jenis bateri yang disyorkan, atau jenis yang berkaitan. Selitkan bateri supaya supaya paksi berada pada kedudukan yang betul. Bateri yang boleh dicaskan semula perlu dicas semula menggunakan pengecas bateri yang betul bawah pengawasan orang dewasa. Anda tidak boleh mengecas bateri semasa bateri masih berada pada produk, dan anda jangan cuba berbuat demikian. Jangan cuba untuk mengecas semula bateri yang tidak boleh dicaskan semula. Jangan pintas litar pemegang bateri.



EN	Protect the environment by not disposing of this product with your household waste (2012/19/EU). Check with your local authority for recycling advice and facilities.
DE	Schützen Sie die Umwelt und entsorgen Sie dieses Produkt nicht mit Ihrem Hausmüll (2012/19/EU). Informationen zu Recycling-Möglichkeiten erhalten Sie bei den örtlichen Behörden.
FR	Protégez l'environnement : ne jetez pas ce produit avec vos autres déchets ménagers (Directive européenne 2012/19/UE). Contactez les autorités locales pour obtenir des informations sur le recyclage et connaître les points de collecte.
IT	Proteggi l'ambiente! Non smaltire questo prodotto con i rifiuti domestici (2012/19/UE). Per consulenza sul riciclaggio dei rifiuti e le strutture di riciclaggio, rivolgersi alle proprie autorità locali.
NL	Bescherm het milieu: gooi dit product niet samen met het andere huisvuil weg (2012/19/EU). Raadpleeg de plaatselijke instanties voor locaties van milieustations en advies over hergebruik.
ES	Proteja el medio ambiente no deshaciéndose de este producto junto con sus residuos domésticos (2012/19/UE). Solicite a su autoridad local consejos e información sobre instalaciones de reciclado.
DA	Beskyt miljøet! Smid ikke dette produkt ud sammen med husholdningsaffaldet (2012/19/EU). Få vejledning om genbrug og genbrugsstationer hos din kommune.
IS	Stuðlið að verndun umhverfis með því að farga þessari vöru ekki með heimilissorpi (2012/19/ESB). Leiðið upplýsinga um endurvinnslu- og förgunarsaði hjá staðaryfirvöldum.
FI	Tämä tuote on hävitettävä ympäristönsuojelun vuoksi asianmukaisesti talousjätteistä erillään (2012/19/EU). Tietoja keräyspisteiden sijainnista saa kunnan tai kaupungin teknisestä virastosta.
SV	Skydda miljön genom att inte kasta denna produkt bland ditt hushållsavfall (2012/19/EU). Kontakta din kommun för frågor om återvinning och miljöstationer.
NO	Beskytt miljøet. Ikke kast dette produktet i husholdningsavfallet (2012/19/EU). Kontakt kommunen for veiledning om gjenbruk og miljøstasjoner.
PT	Proteja o ambiente não eliminando este produto com o seu lixo doméstico (2012/19/UE). Consulte as autoridades locais para informação sobre reciclagem e sistemas de recolha.
EL	Προστατέψτε το περιβάλλον. Μην πετάτε αυτό το προϊόν μαζί με τα συνηθισμένα οικιακά απόβλητα (2012/19/ΕΕ). Επικοινωνήστε με τις τοπικές αρχές σχετικά με συμβουλές και εγκαταστάσεις ανακύκλωσης.
JA	環境保護のため、本製品は家庭ごみとは別に処分してください(2012/19/EU)。リサイクルに関する指示や施設については、お住まいの地方自治体にお問い合わせください。
ZH	注意保护环境，请勿将本产品与家庭垃圾一起丢弃处理(2012/19/EU)。请咨询您当地相关部门，了解回收设施与回收建议
KO	환경 보호를 위해 이 제품을 생활폐기물과 함께 버리지 마십시오(2012/19/EU)。재활용 방법 및 시설에 관한 사항은 현지 관계 당국에 문의하십시오。
RU	Защищайте окружающую среду, не утилизируйте этот продукт вместе с бытовым мусором (директива 2012/19/EU). Осведомитесь у местных органов власти о правилах вторичной переработки и утилизации таких отходов.
PL	Chroń środowisko — nie wyrzucaj tego produktu razem z odpadami z gospodarstwa domowego (2012/19/EU). W celu uzyskania informacji dotyczących recyklingu i miejsc składowania zużytego sprzętu należy się skontaktować z lokalnymi władzami.
CZ	Nevyhazujte tento produkt do domácího odpadu, chráňte životní prostředí (2012/19/EU). Zjistěte si prosím u místních úřadů možnosti recyklace a dostupná zařízení.
SK	Nevyhádzajte tento produkt do domáceho odpadu, chráňte životné prostredie (2012/19/EU). Zistite si prosím na miestnych úradoch možnosti recyklácie a dostupné zariadenia.
HU	Környezetét óvja, ha ettől a terméktől nem a háztartási hulladékkal együtt válik meg (2012/19/EU). Érdeklődjék a lakóhelyéhez közel eső hatóságnál az újrahásznosítás módjáról és lehetőségeiről.
UA	Допоможіть захистити довкілля: не утилізуйте цей виріб разом із побутовим сміттям (2012/19/EU). Вказівки з утилізації та відомості про пункти прийому з'ясуєте в місцевих компетентних органах.
HR	Zaštitite okoliš tako da ovaj proizvod ne odložite u otpad zajedno s kućanskim otpadom (2012/19/EU). Od lokalnih vlasti zatražite savjet ili informacije o pogonima za recikliranje.
SR	Заштитите животну средину тако што нећете одлагати овај производ са кућним отпадом (2012/19/EU). Обратите се локалној овлашћеној служби да бисте добили савете о рециклирању и сазнали о објектима за рециклажу.
MK	Заштитете ја околната така што нема да се ослободите од производот со домашниот отпад (2012/19/EU). Консултирајте се со локалните власти за да дознаете за советите и објектите за рециклирање.
SL	Zaščitite okolje! Okolje varujte tako, da tega izdelka ne zavržete skupaj z gospodinjiskimi odpadki (2012/19/EU). Pri krajevni upravi preverite, kakšne možnosti in kateri obrati za recikliranje obstajajo v vaši okolici.
RO	Protejați mediul înconjurător și nu vă debarasați de acest produs împreună cu deșeurile menajere (2012/19/UE). Consultați autoritățile locale pentru îndrumări și facilități de reciclare.
BG	Защитете околната среда и не изхвърляйте този продукт заедно с битовите си отпадъци (2012/19/EC). Свържете се с местните власти относно съвети и съоръжения за рециклиране.
LV	Lai saudzētu vidi, neizmetiet šio izstrādājumu kopā ar sadzīves atkritumiem (2012/19/ES). Vērsieties vietējās varas iestādēs, lai noskaidrotu, kur un kā tas nododams pārstrādei.
ET	Keskonda saate kaitsta nii, et ei kõrvalda seda toodet koos olmejäätmetega (2012/19/EL). Nõuandeid toote taaskasutusse võtmise ja ümbertöötlemispunktide kohta saate asjaomaset kohalikult asutusest.
LT	Saugokite aplinką: neišmeskite šio produkto su buitineis atliekomis (2012/19/ES). Patarimų, kaip ir kur rūšiuoti šiukšles, teiraukitės vietos valdžios įstaigose.
TR	Bu ürünü, evsel atıklarla birlikte atmayarak çevreyi koruyun (2012/19/EU). Geri dönüşüm tavsiyeleri ve tesisler hakkında bilgi için yerel yönetimle iletişim kurun.
AR	(2012/19/EU) استشر السلطة المحلية للحصول على استشر السلطات المحلية مع الخلفات المنزلية استشر السلطة المحلية للحصول على
ID	Jagalang lingkungan dengan tidak membuang produk ini bersama sampah rumah tangga Anda (2012/19/EU). Periksa peraturan pemerintah setempat tentang saran dan fasilitas daur ulang.
MS	Lindungi persekitaran dengan tidak melupuskan produk ini bersama dengan sisa isi rumah anda (2012/19/EU).Rujuk pihak berkuasa tempatan anda bagi nasihat dan kemudahan kitar semula.

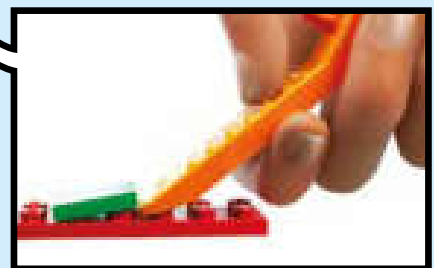
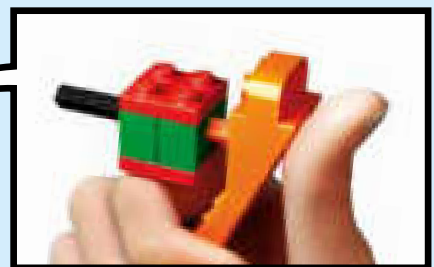
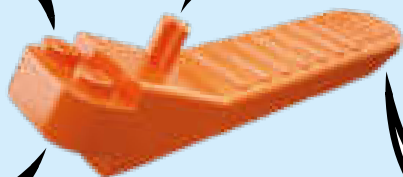
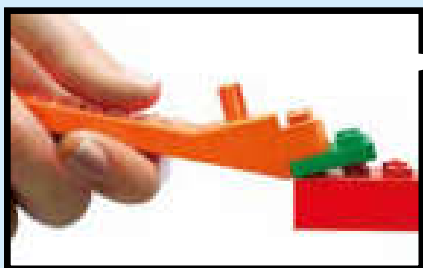

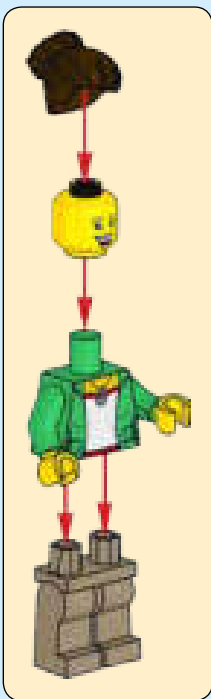
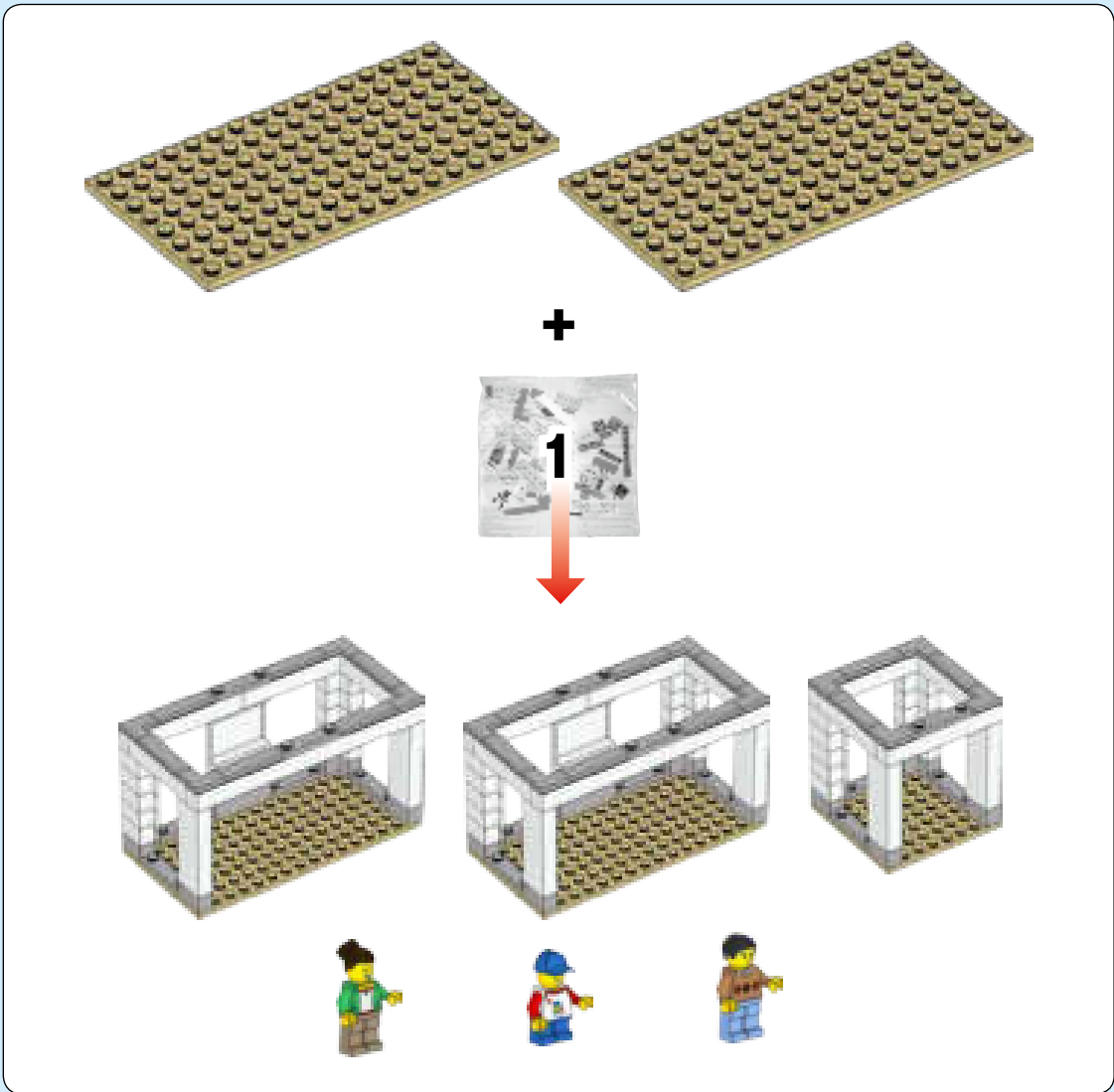

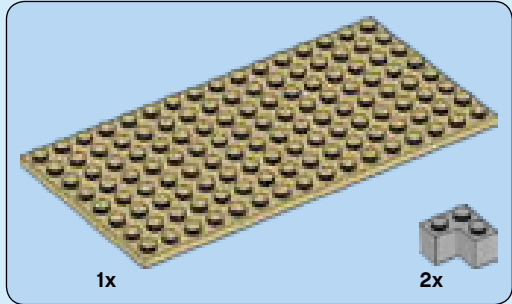
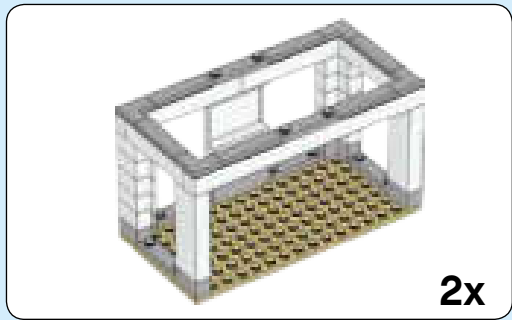

1

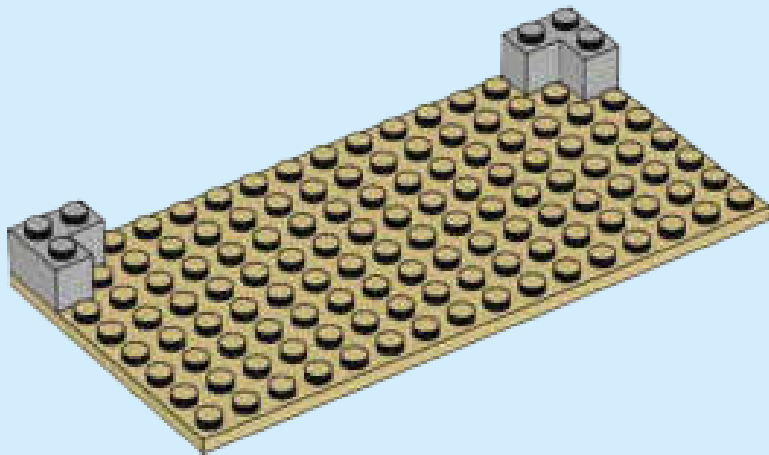



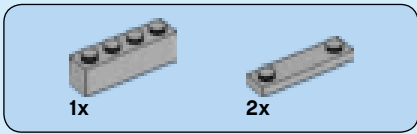

2

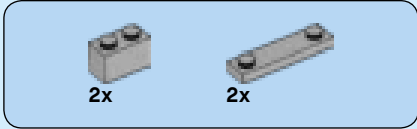
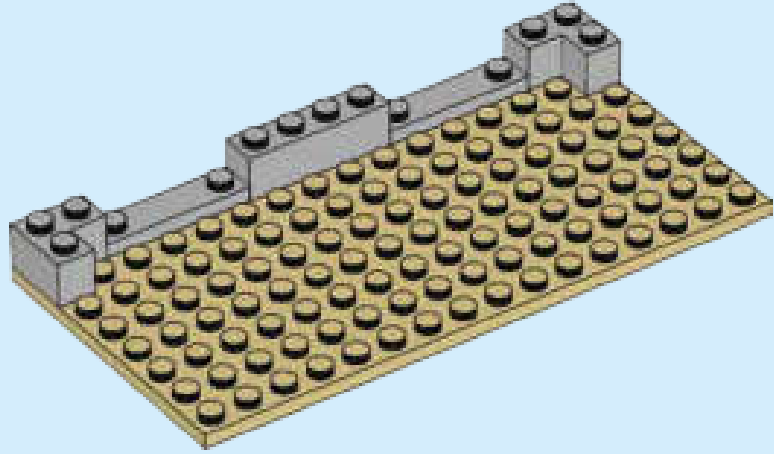

3

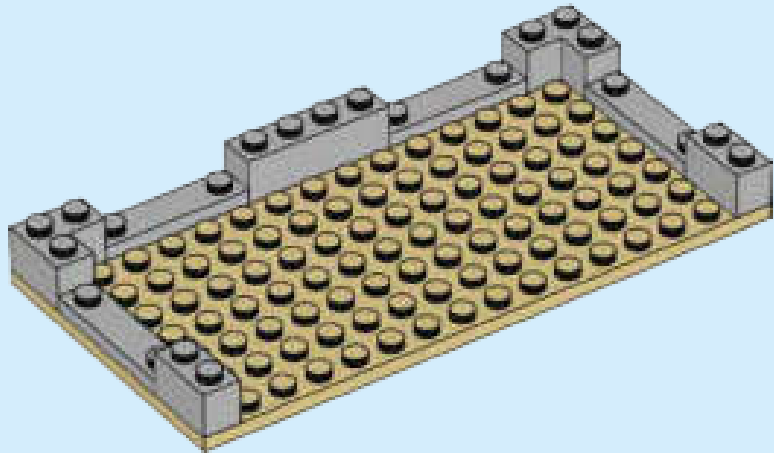



10x

4

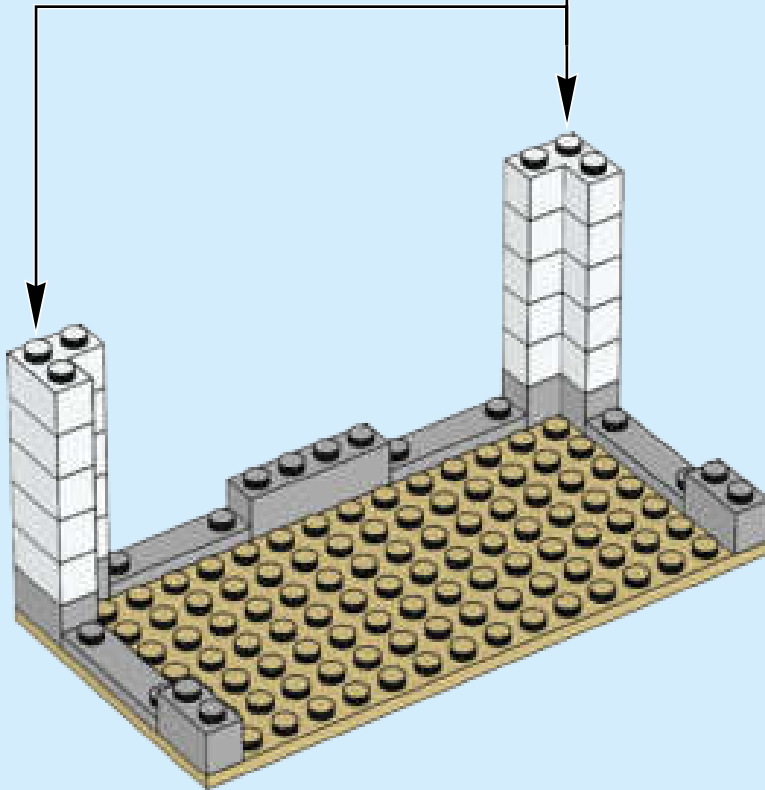
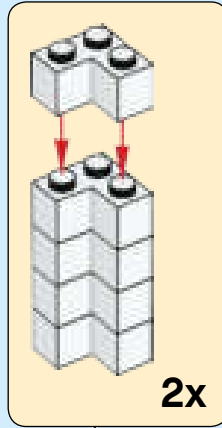

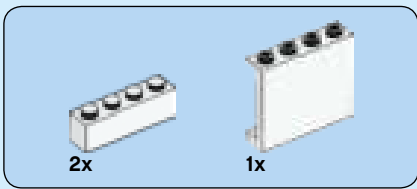

5

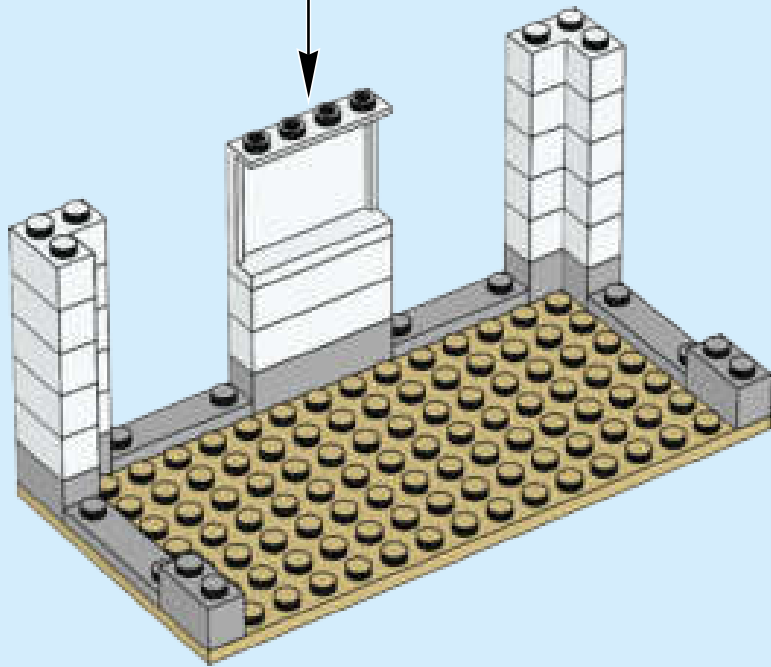
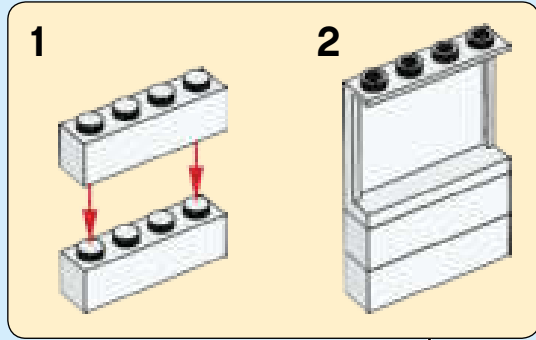

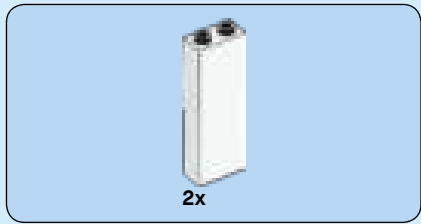

6

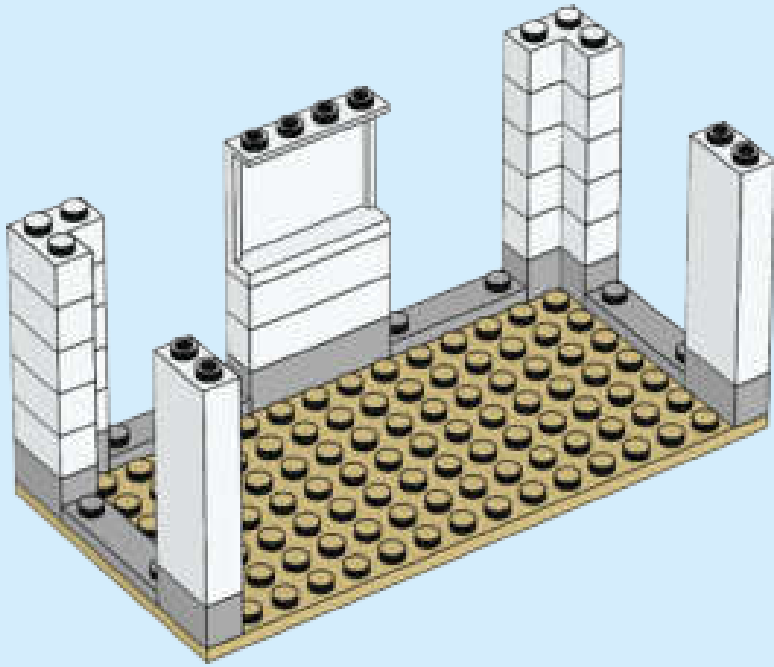

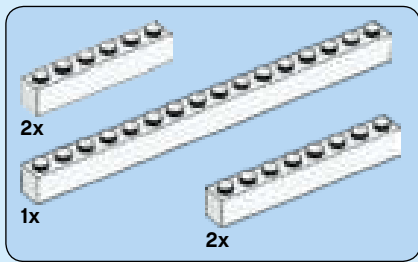

7

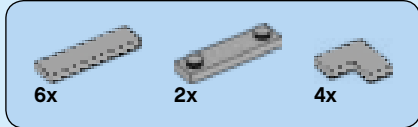
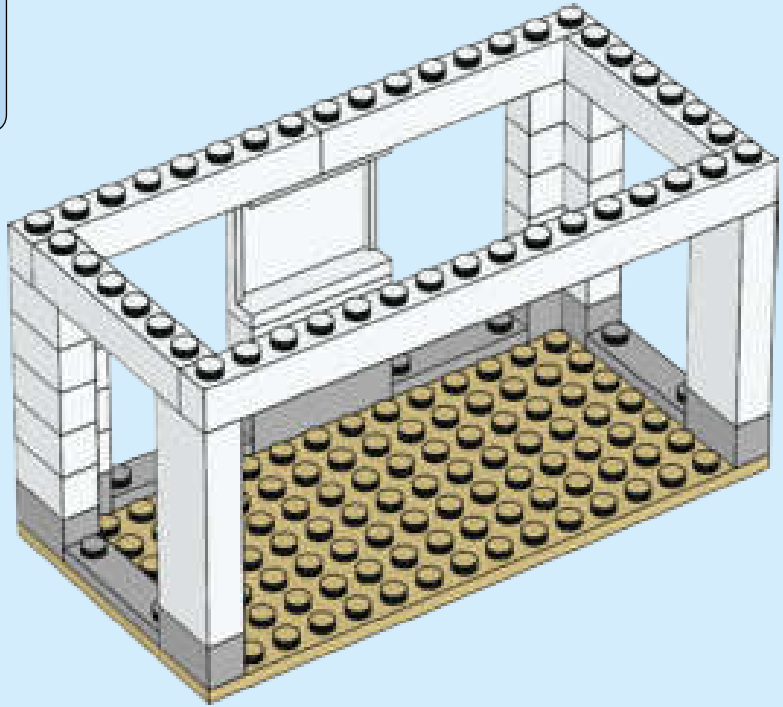

8

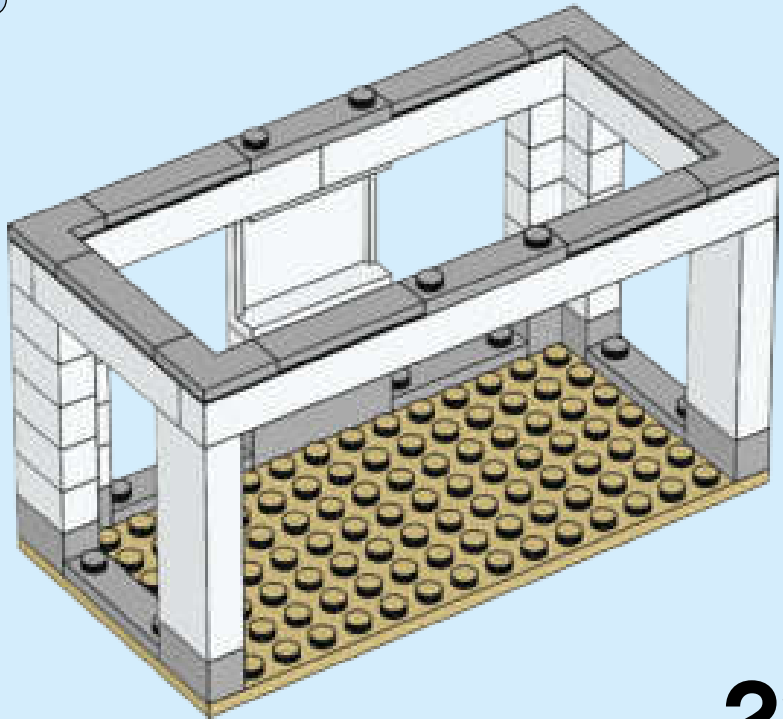

2x

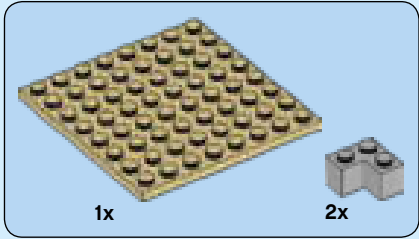
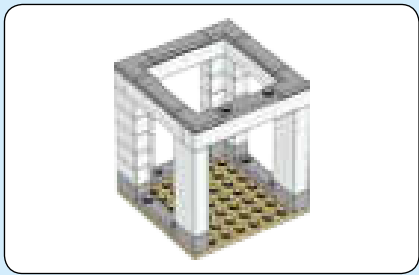

9

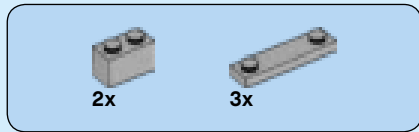
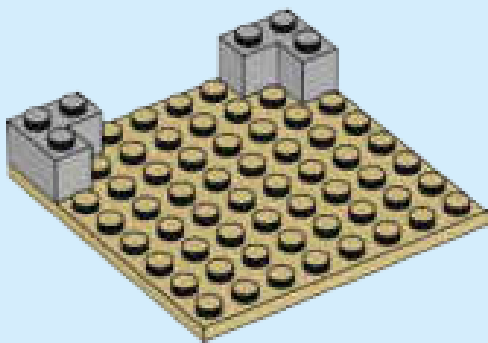

10

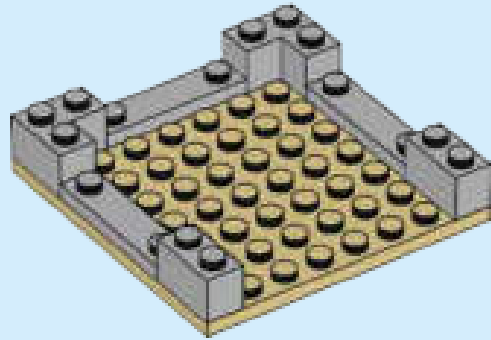

11

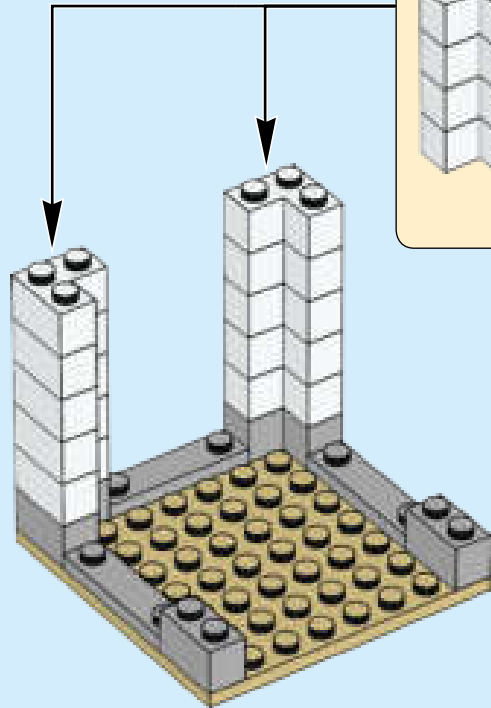
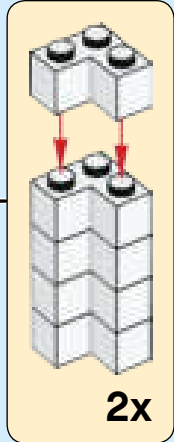

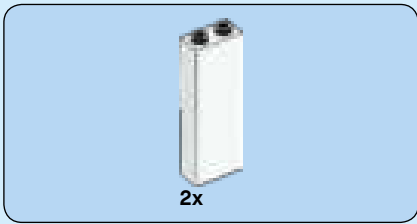

12

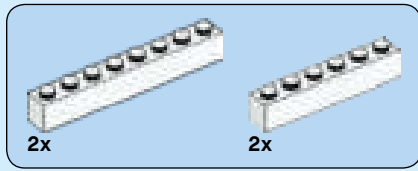
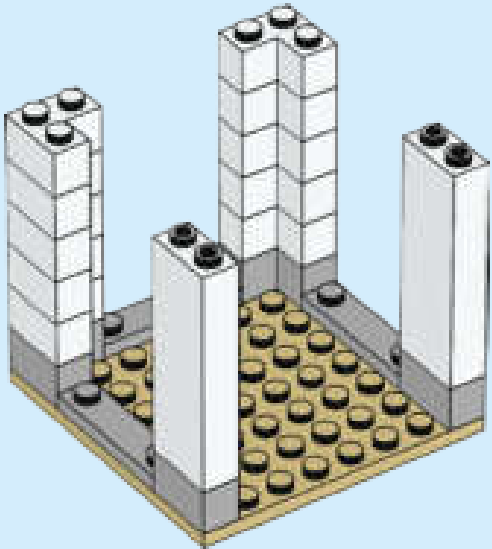

13

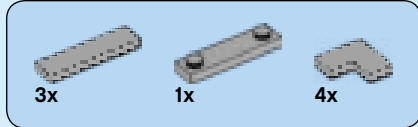
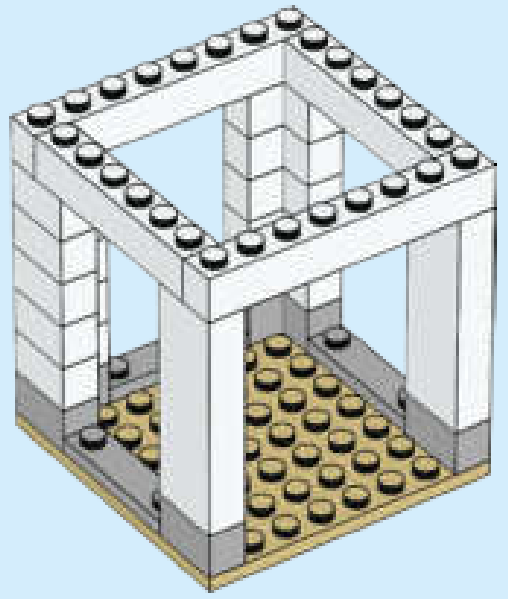

14

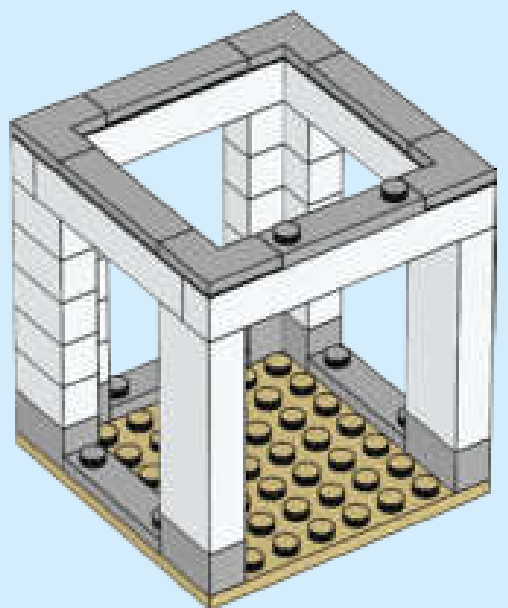

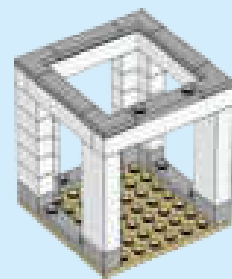
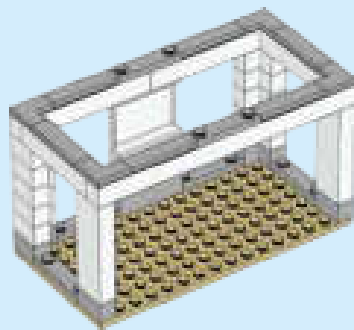
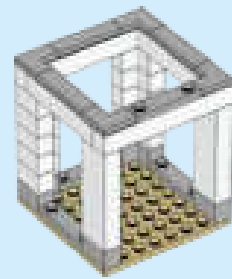
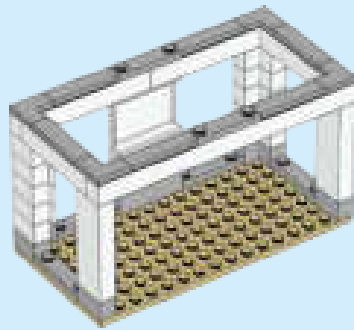
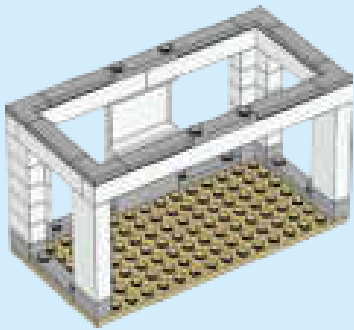
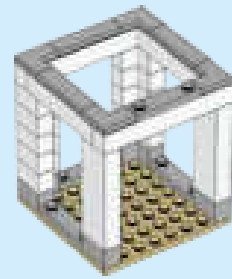
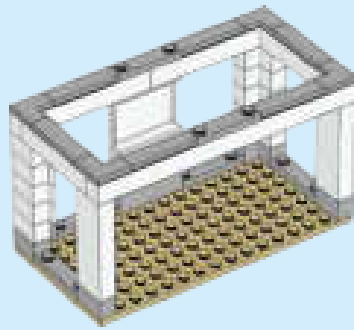
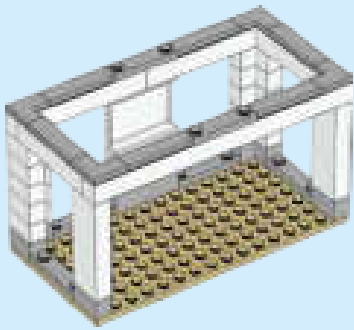



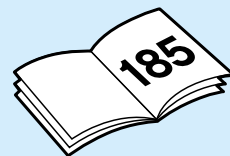
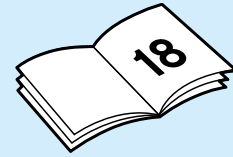



+



+



+



+



+





1

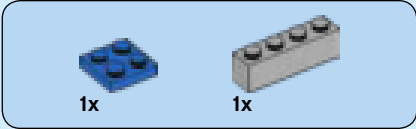
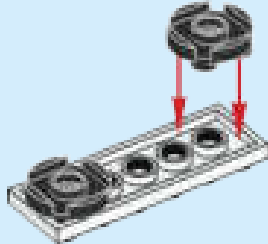

2

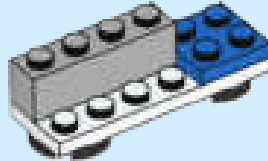
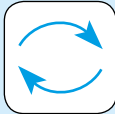

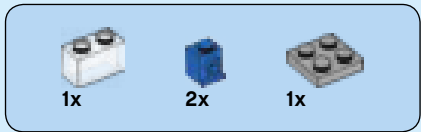

3

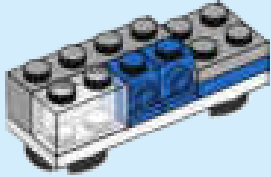

4

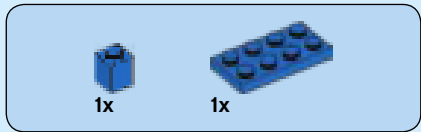
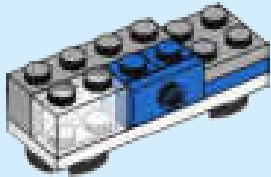

5

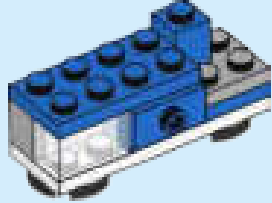

6

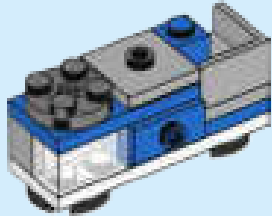

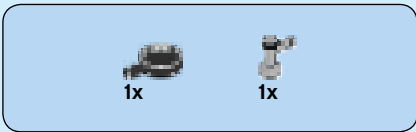

7

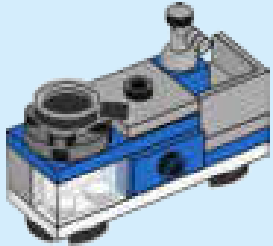

8

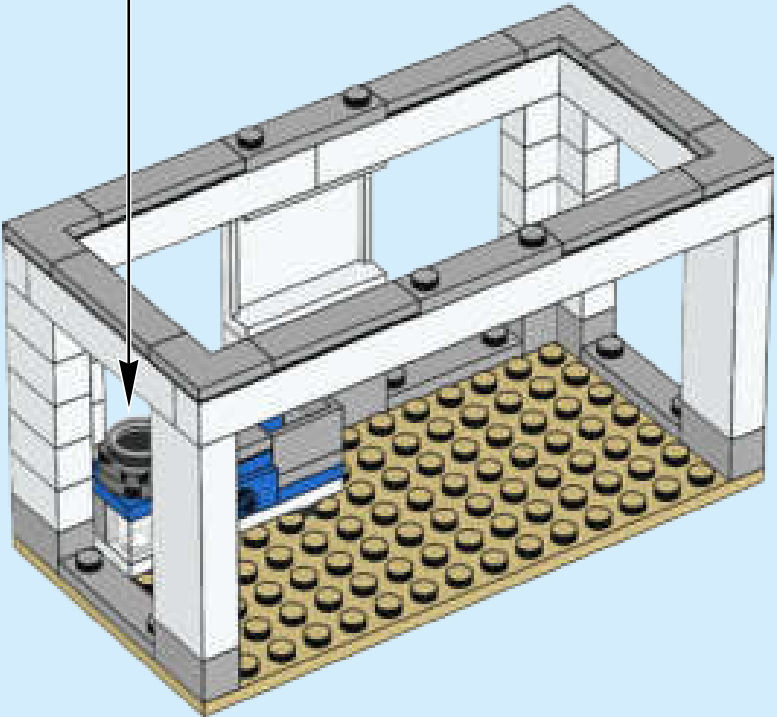

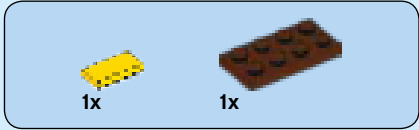

9

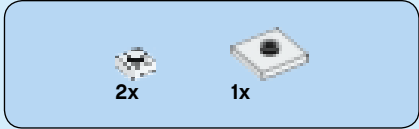

10

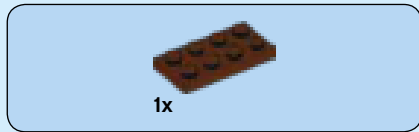

11



12

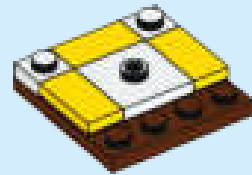

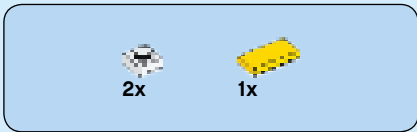

13

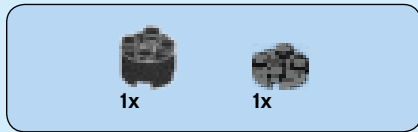
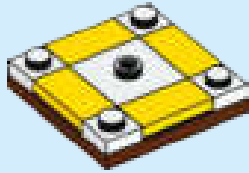

14

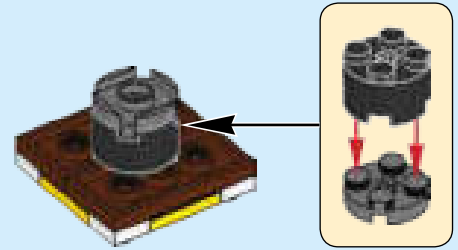
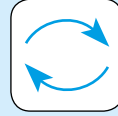

15

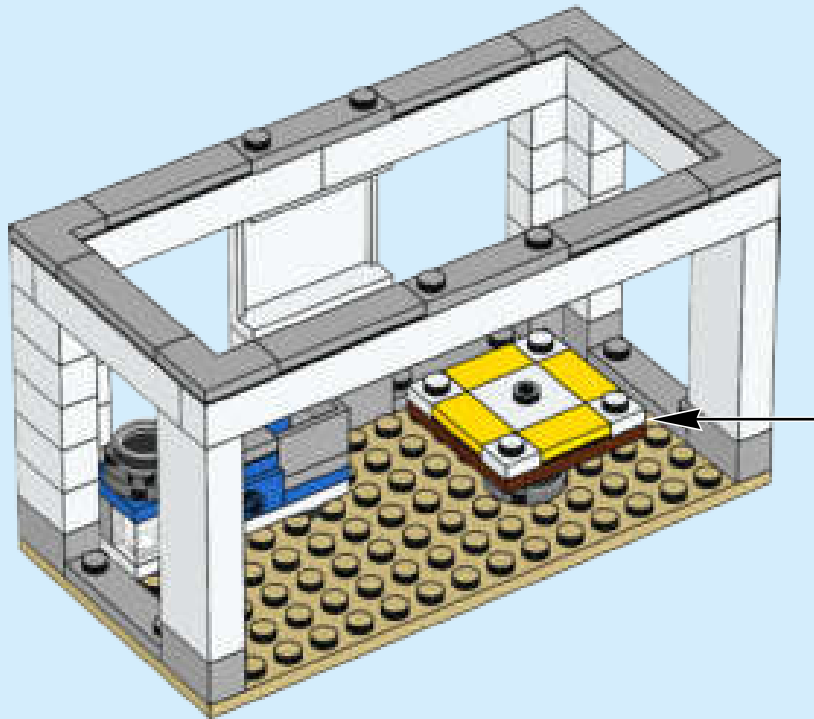

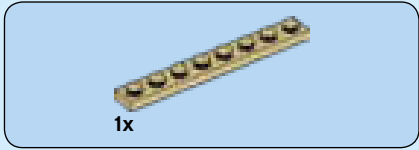
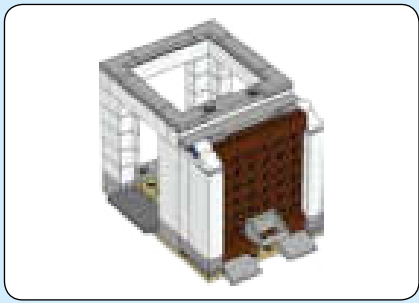

**16**

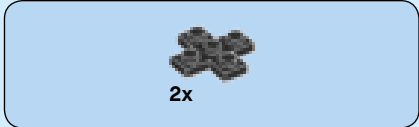
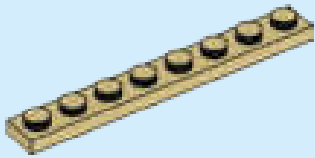

**17**

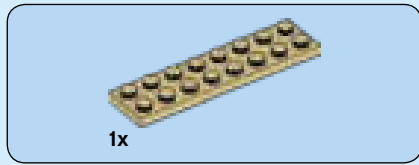
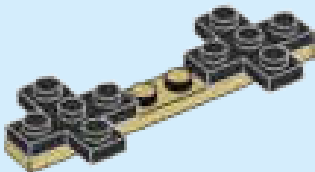

**18**

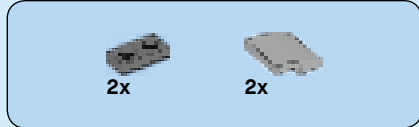
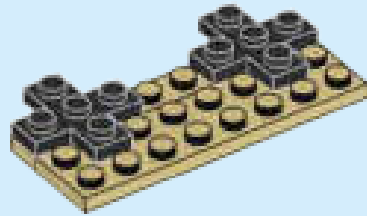

**19**

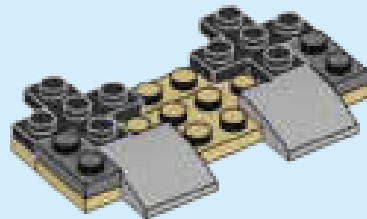



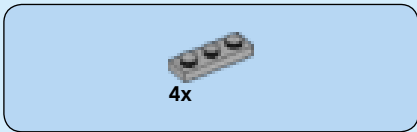

20

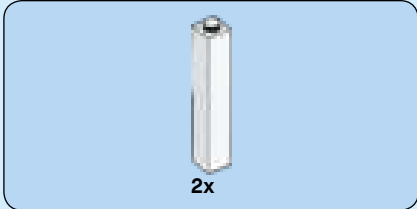
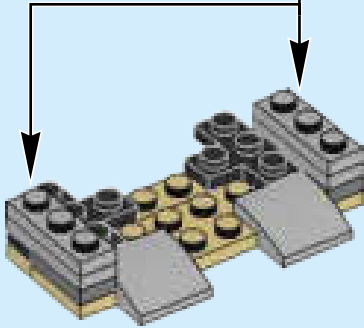
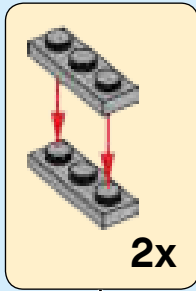

21

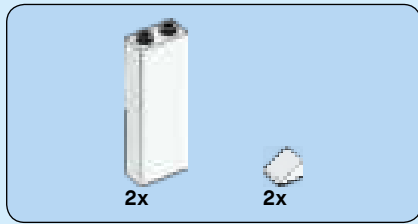
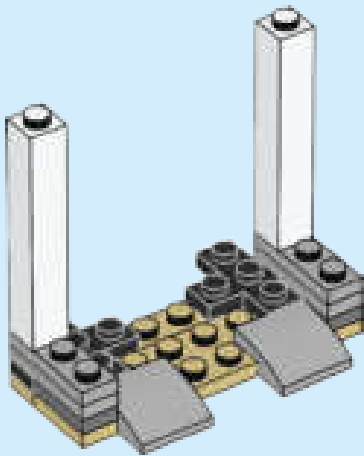

22

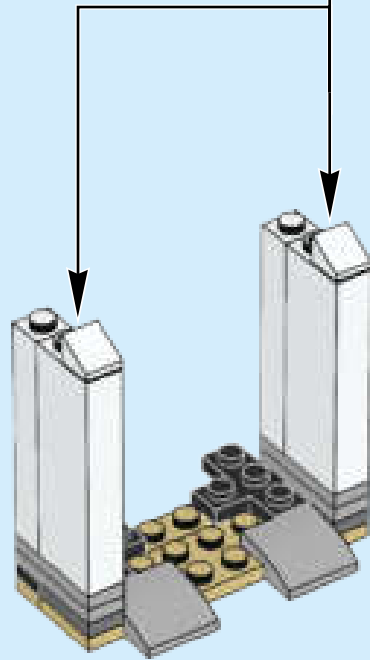
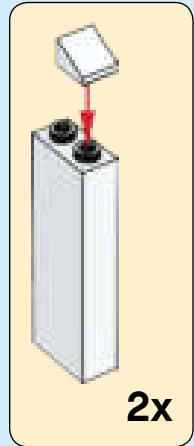

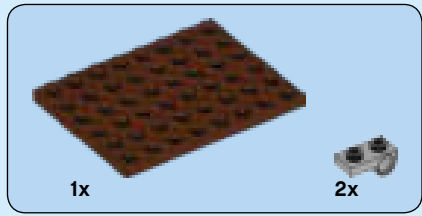

23

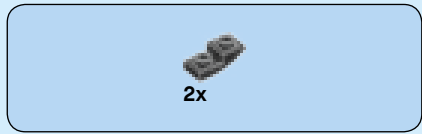
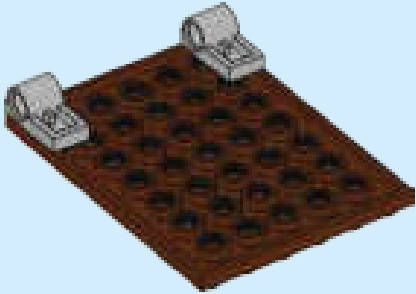

24



25





30

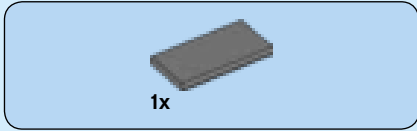
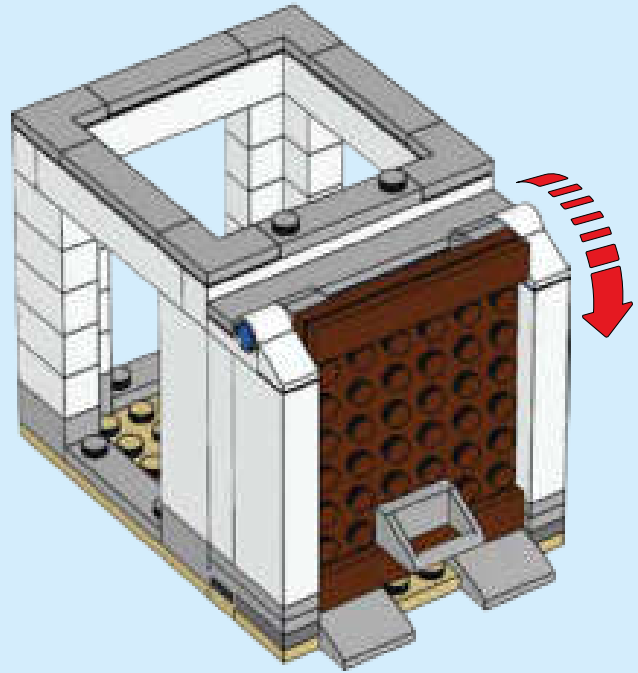
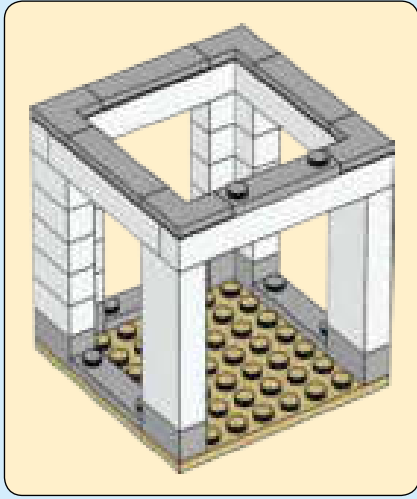

31

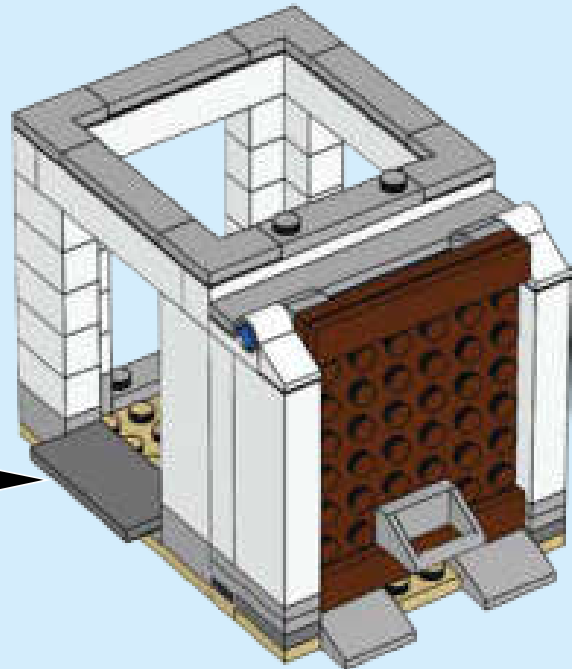
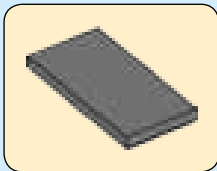

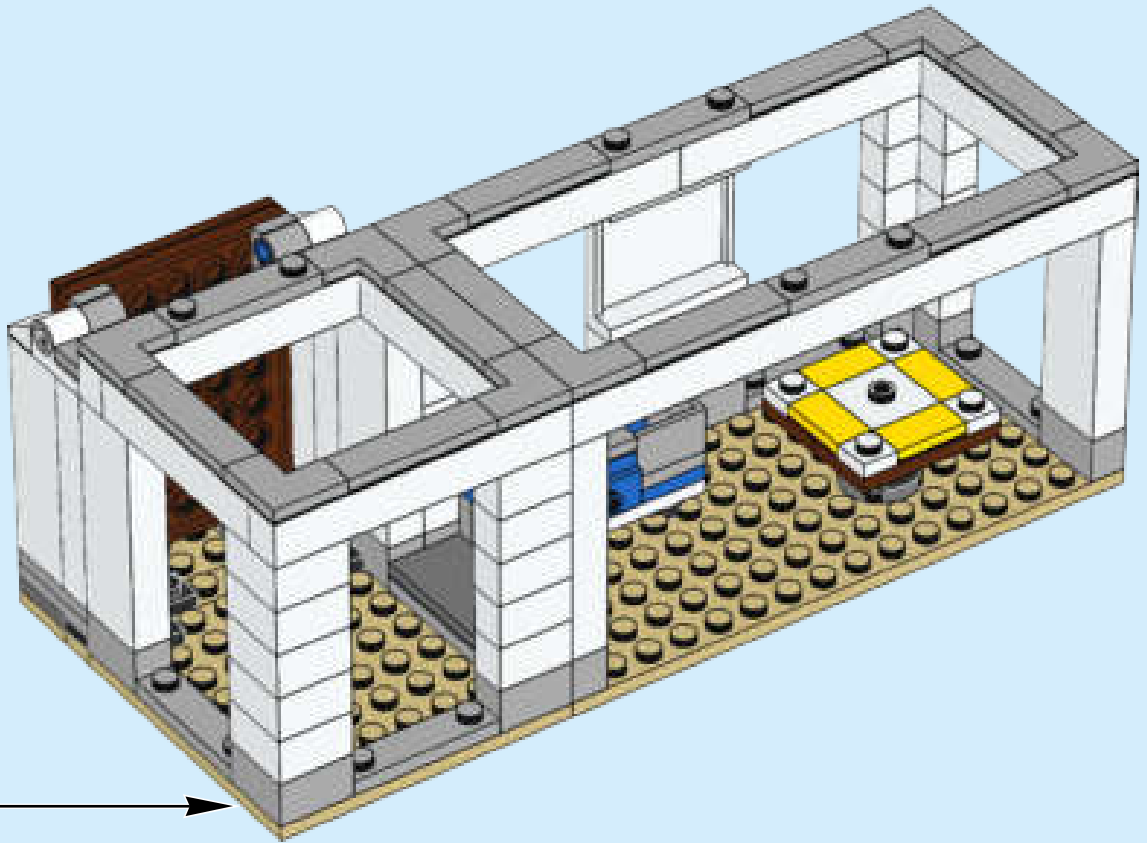

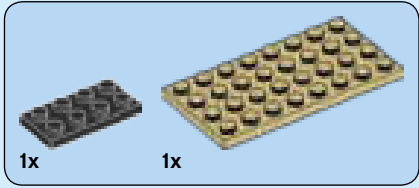
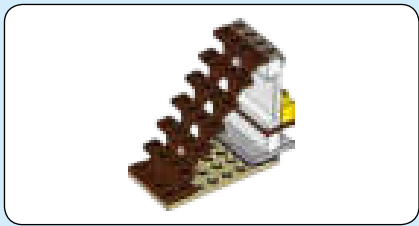

33

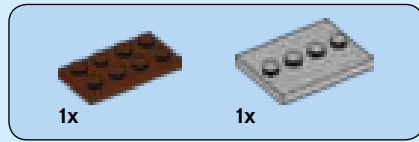
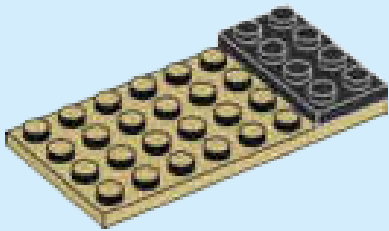

34

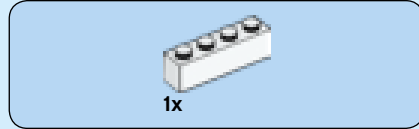
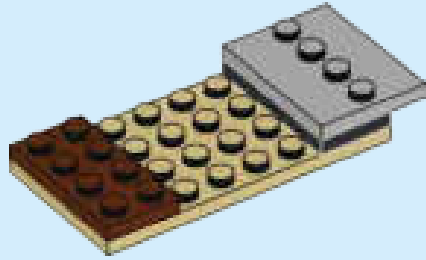

35

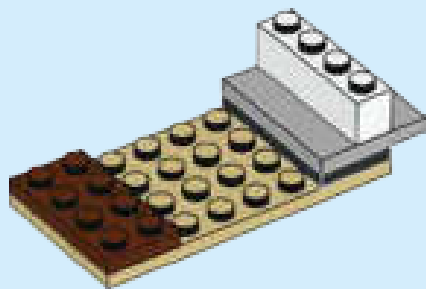

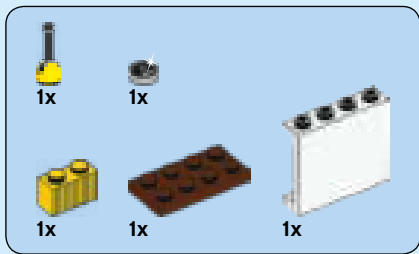

36

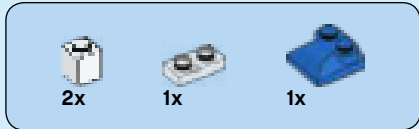
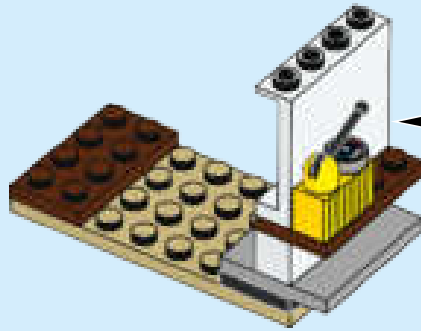

37

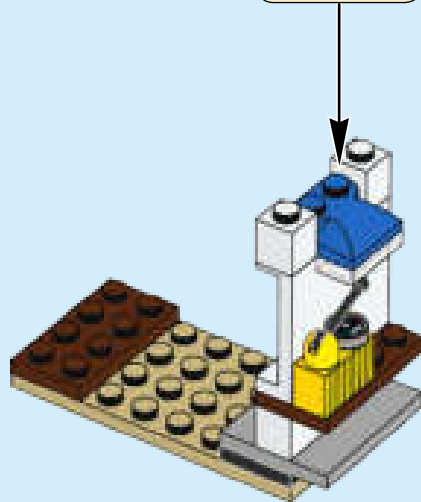
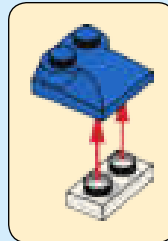

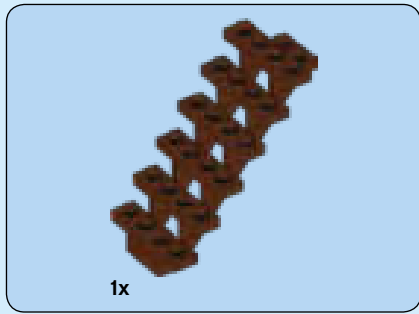

38

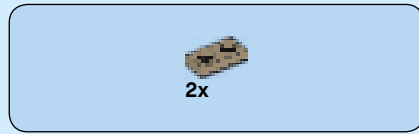
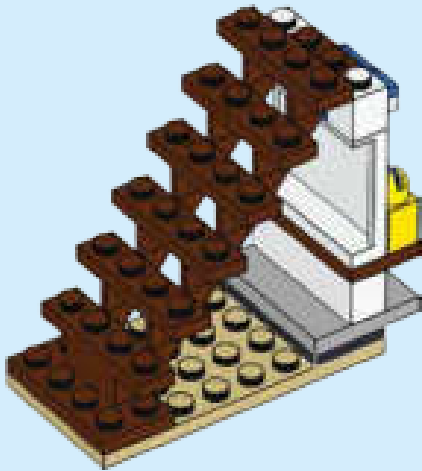

39

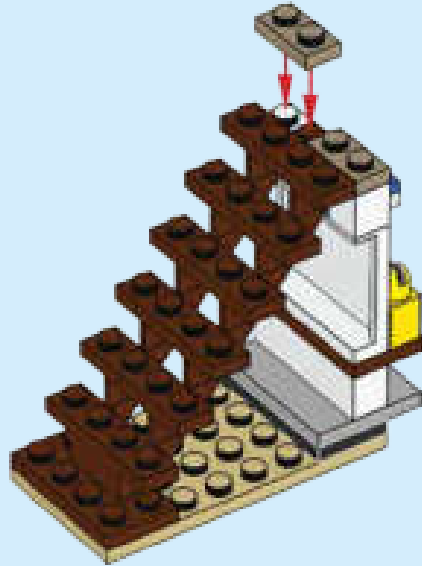



40

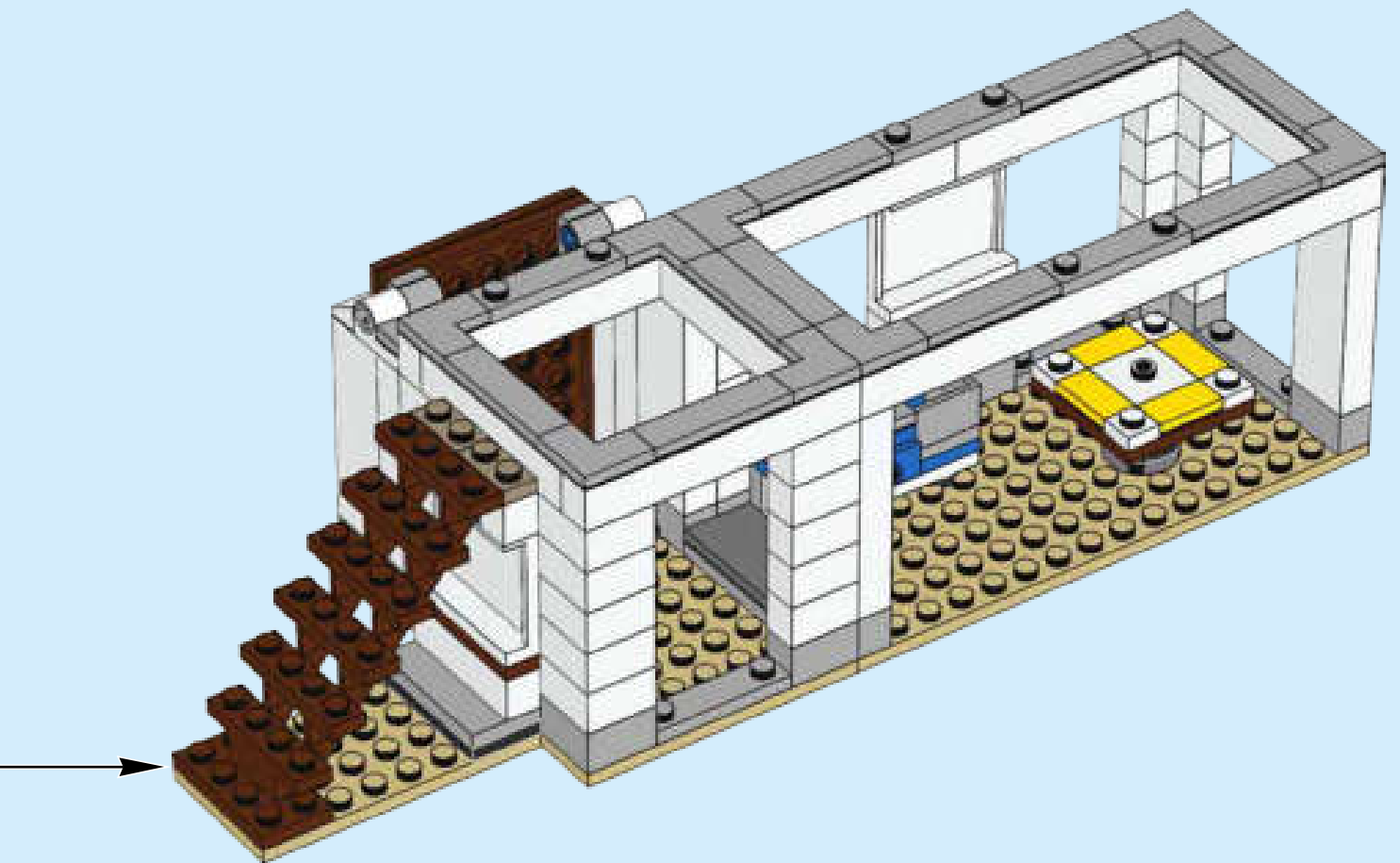

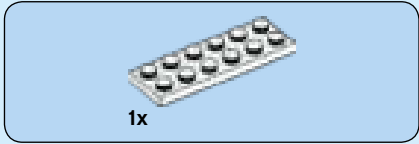

1x

# 41

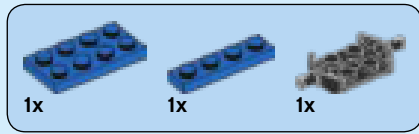
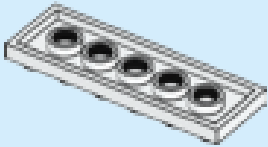

1x

1x

1x

# 42

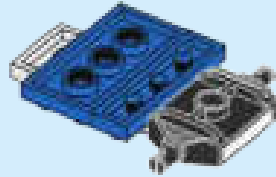

1x

# 43

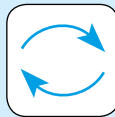

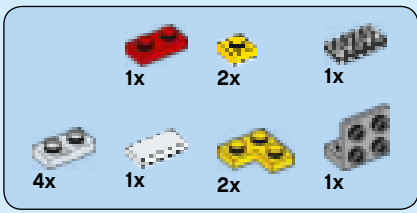

# 44

1

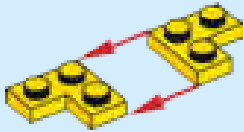

2



3



4

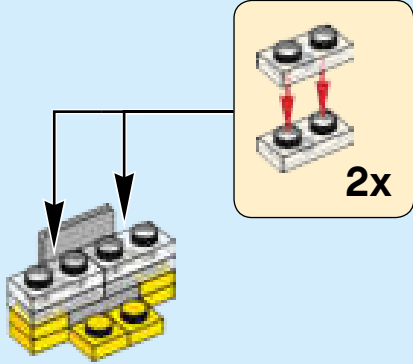

5

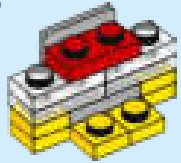

6

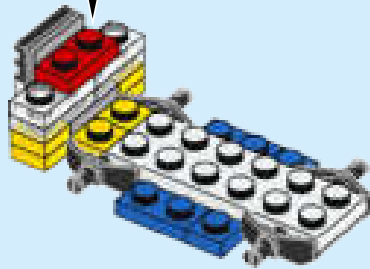
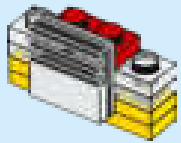

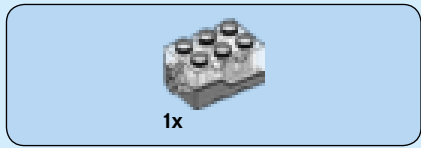

45

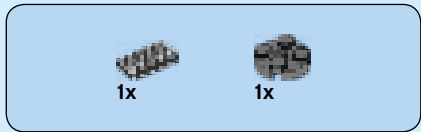
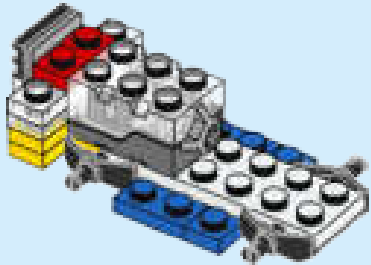

46

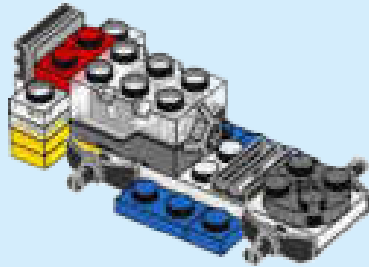

47

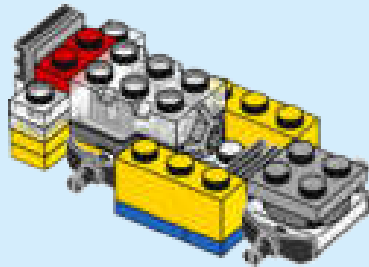

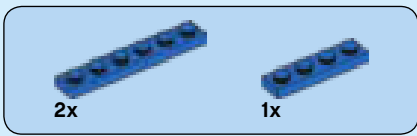

48

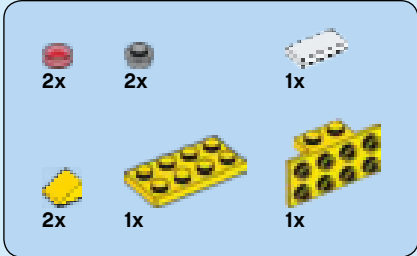
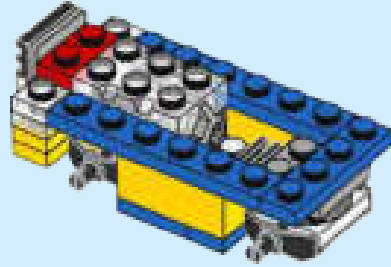

49

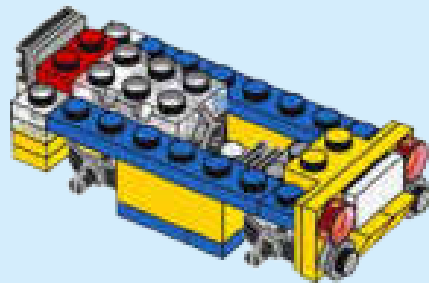
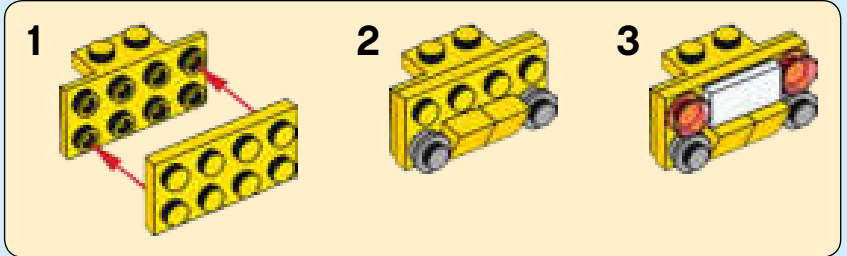

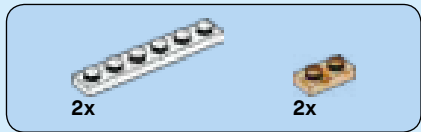

# 50

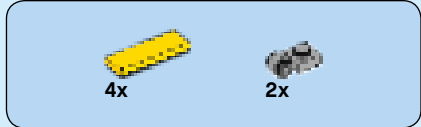
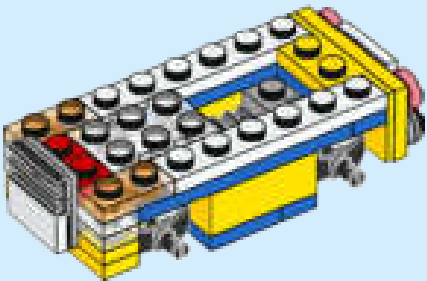

# 51

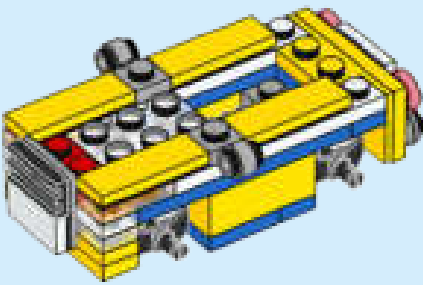



52

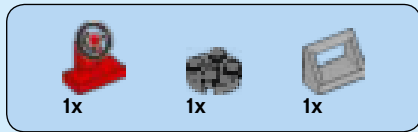
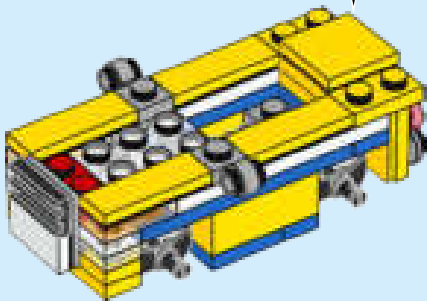

53

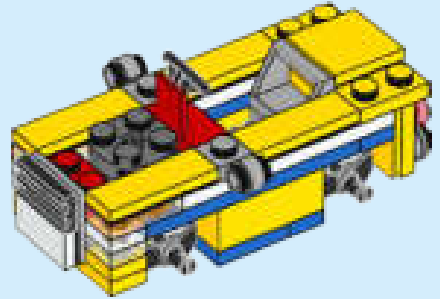

54

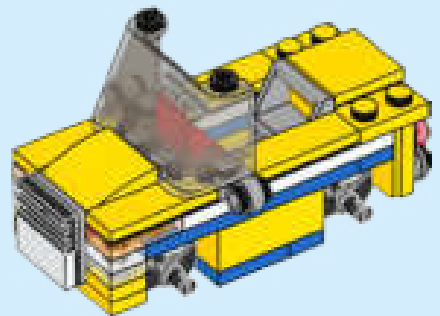

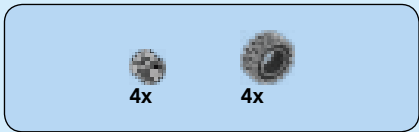

55

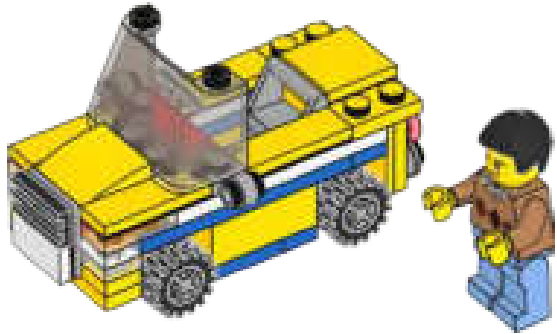
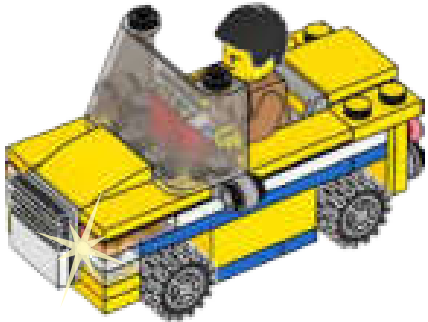
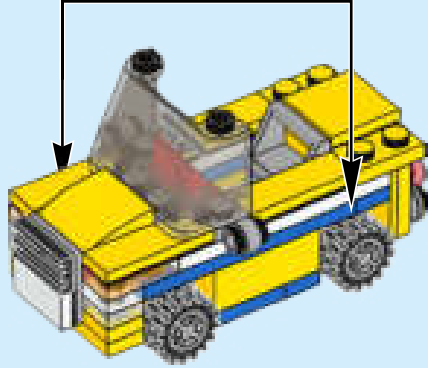
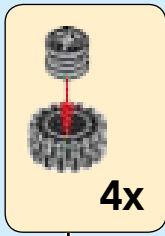



56

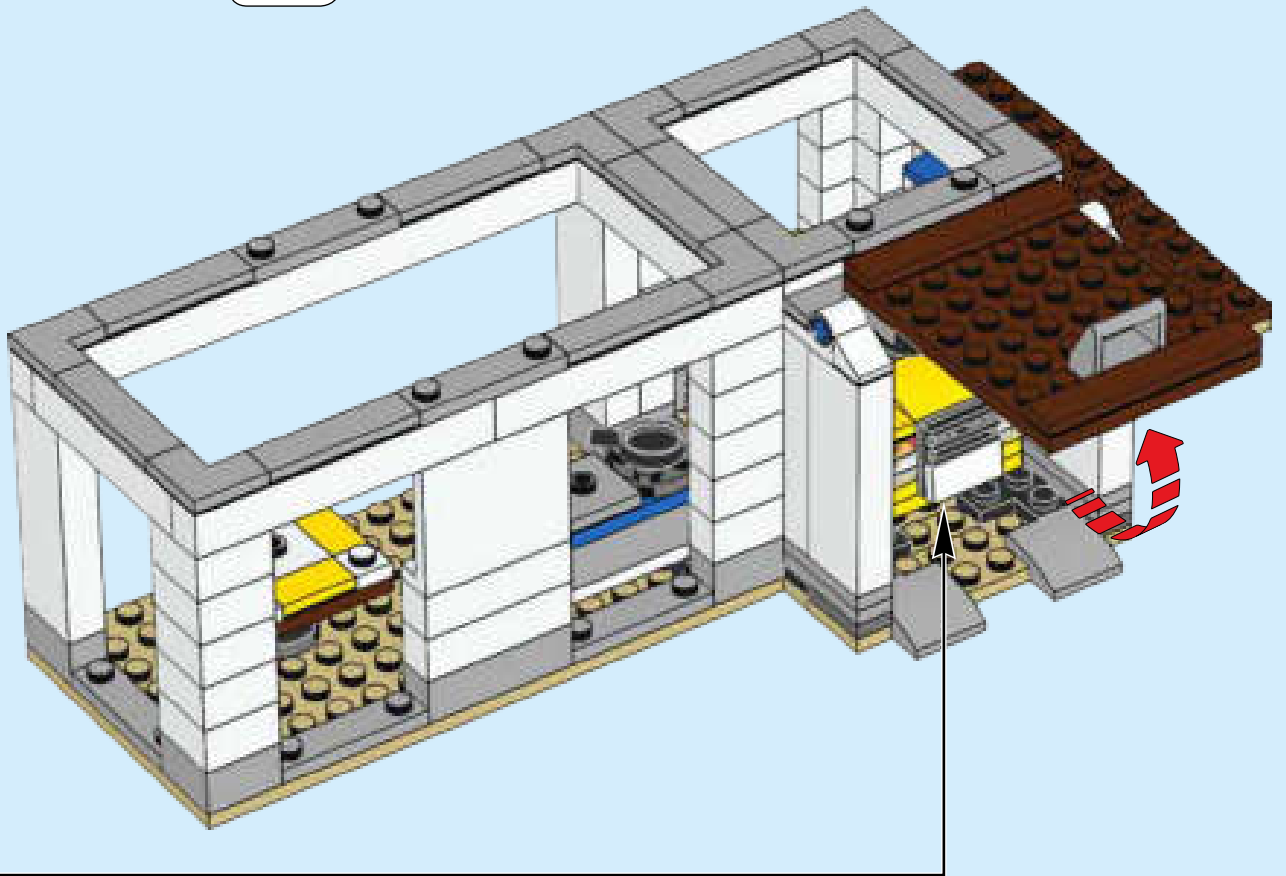
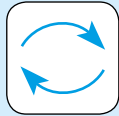

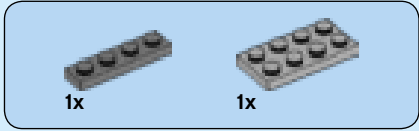

57

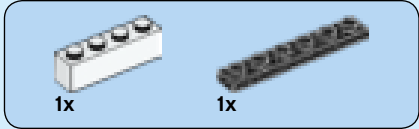
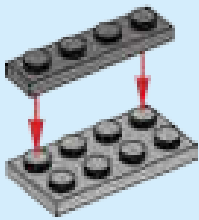

58

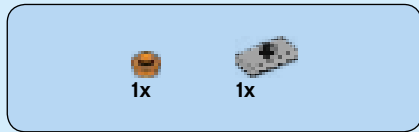
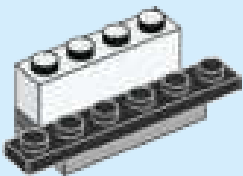

59



60

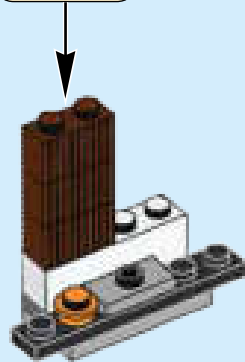

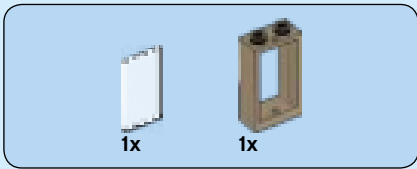

61

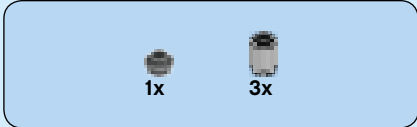
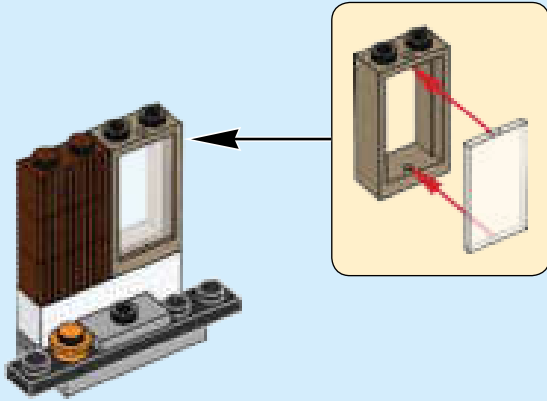

62

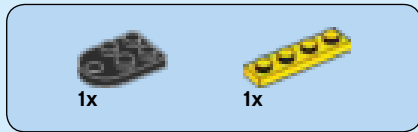
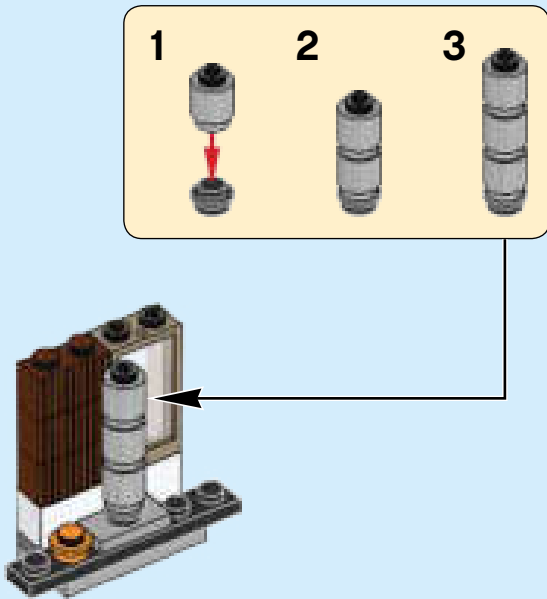

63

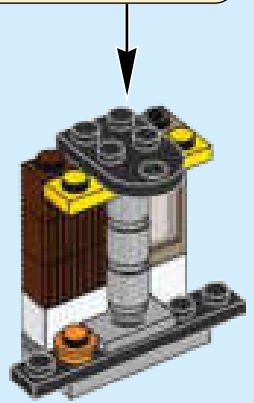
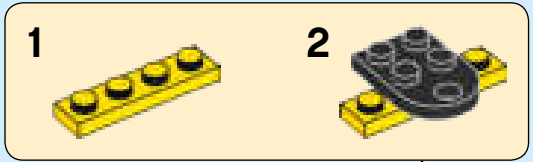

64

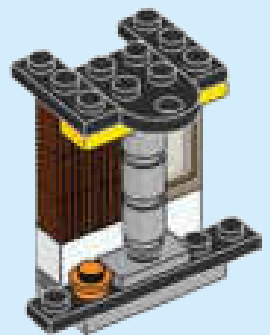



2x

65

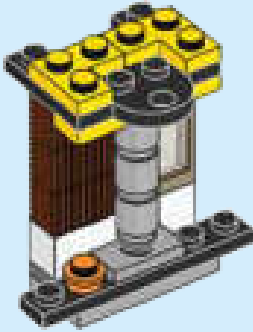

1x



2x

66

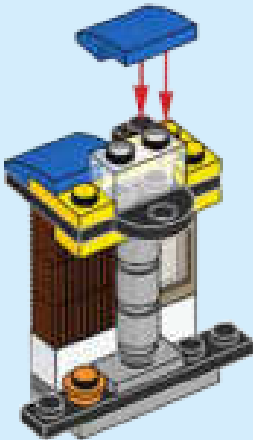

2x

67

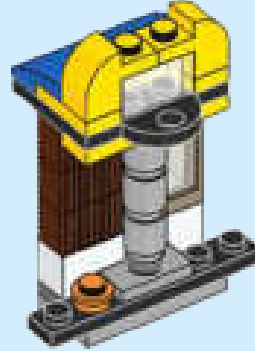

1x



1x

68

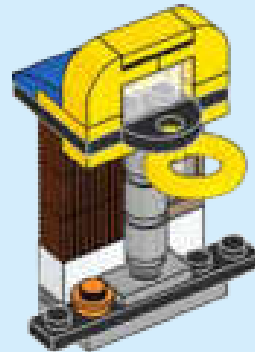

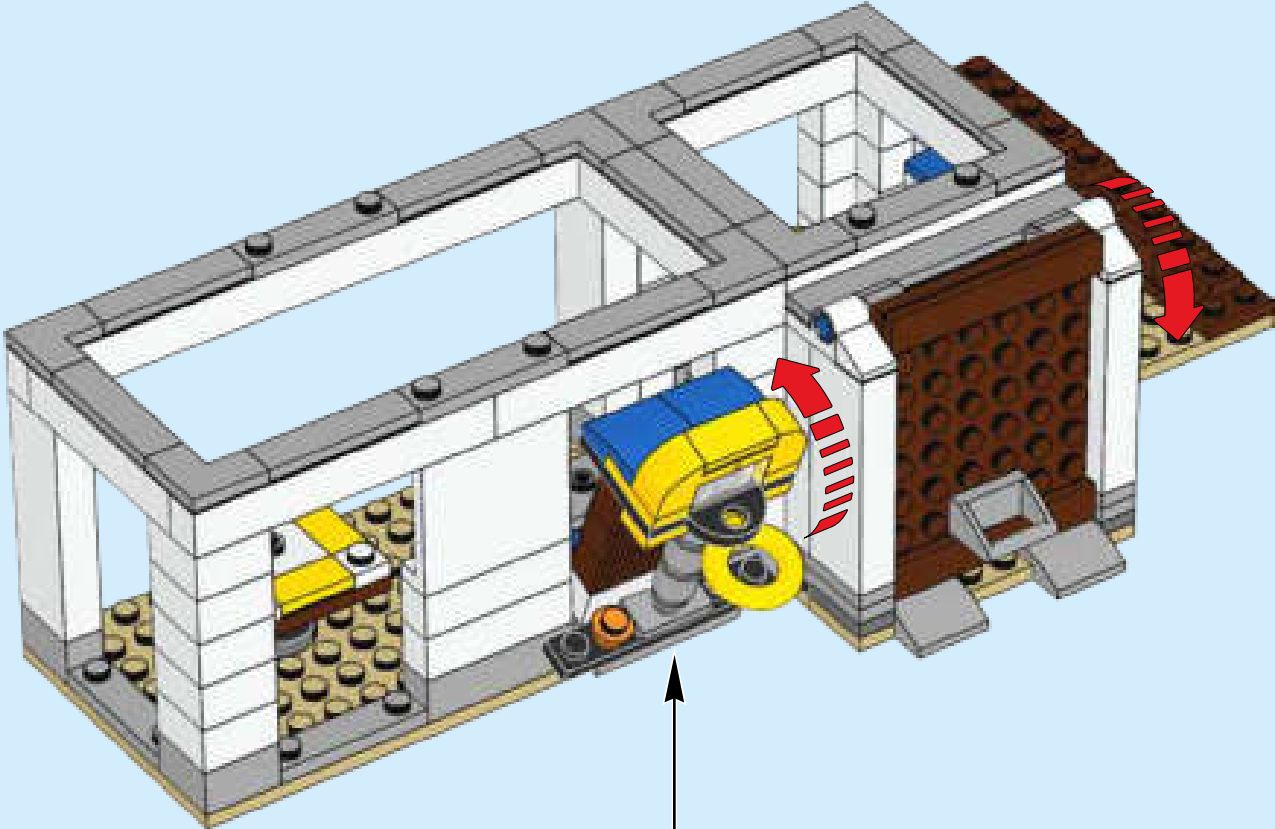

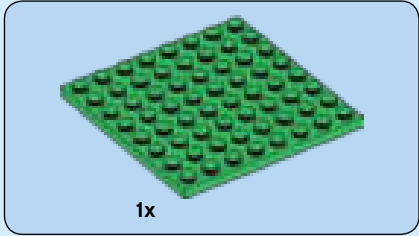

1x

70

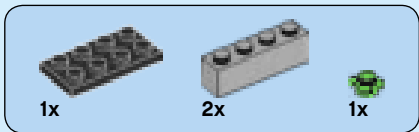
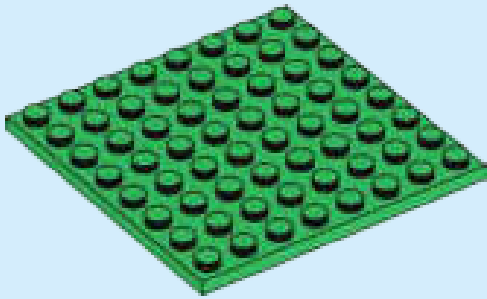

1x

2x

1x

71

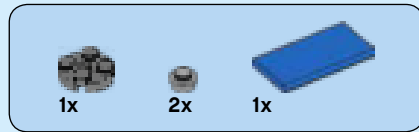
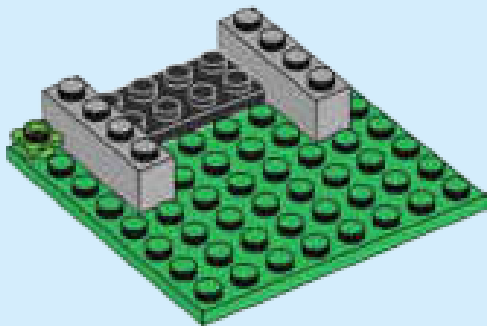

1x

2x

1x

72

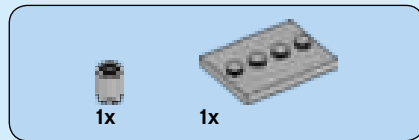
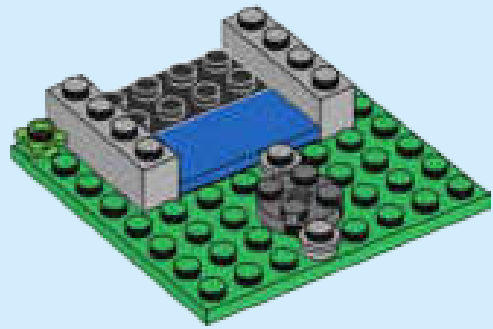

1x

1x

73

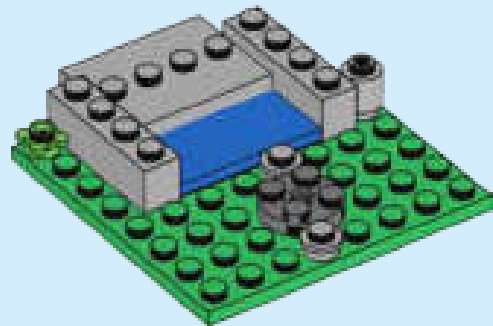

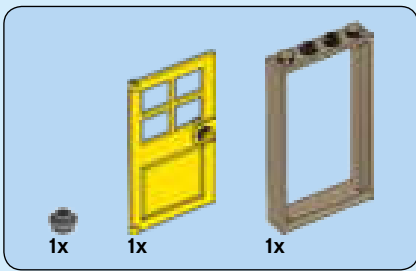

74

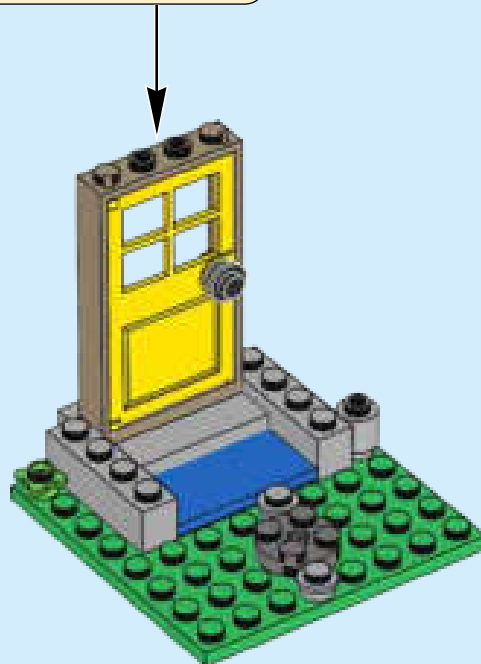
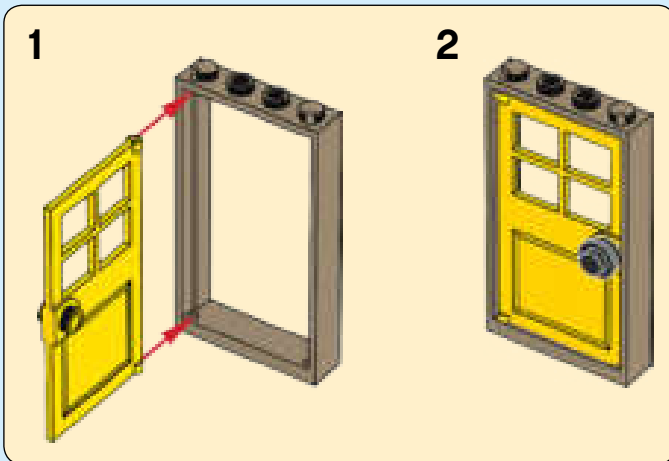



4x



4x

75

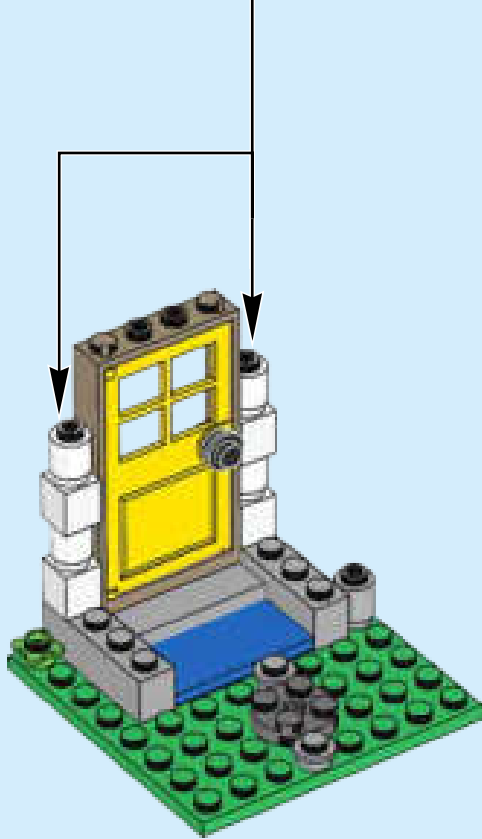
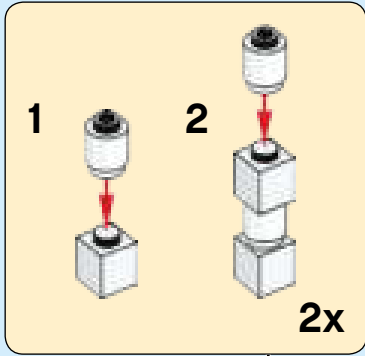



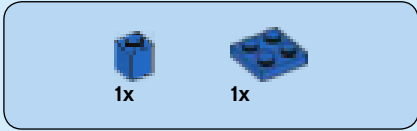

76

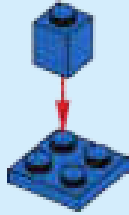

77

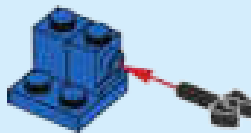

78



79





2x

80



1x



1x

81

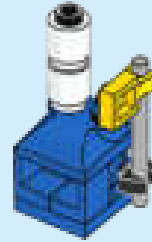
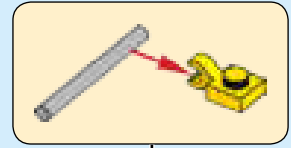

82

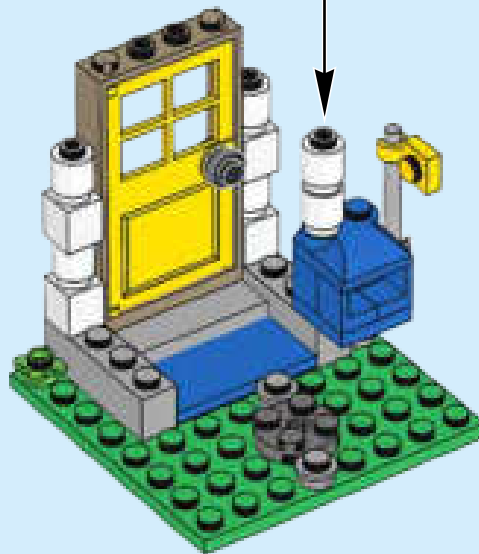

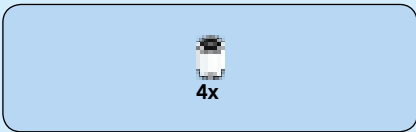

83

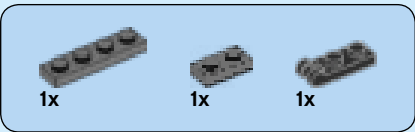
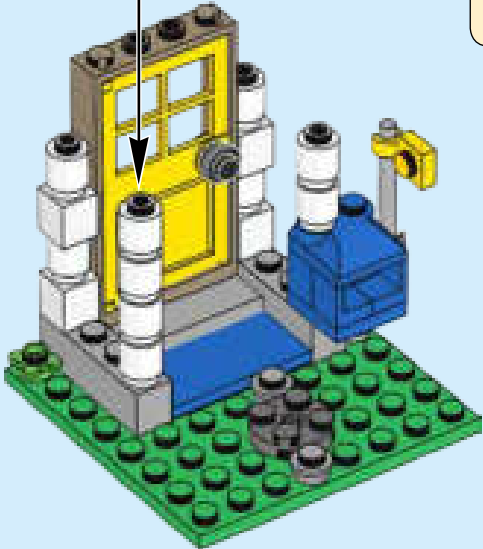

85

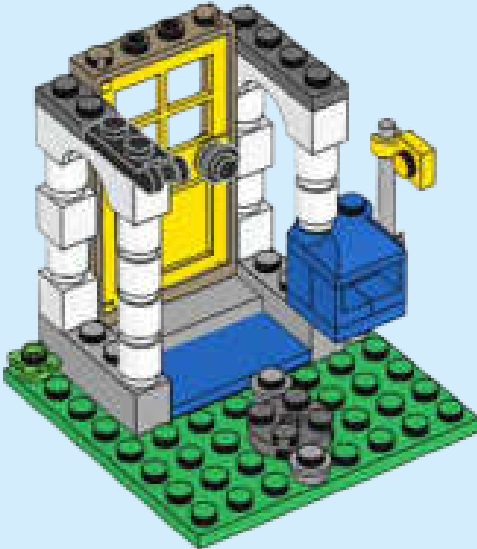

84

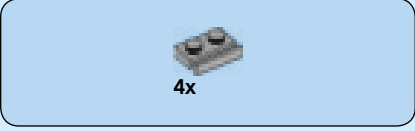
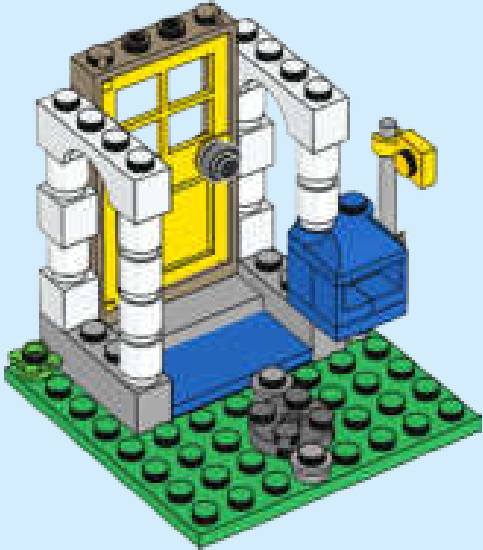

86

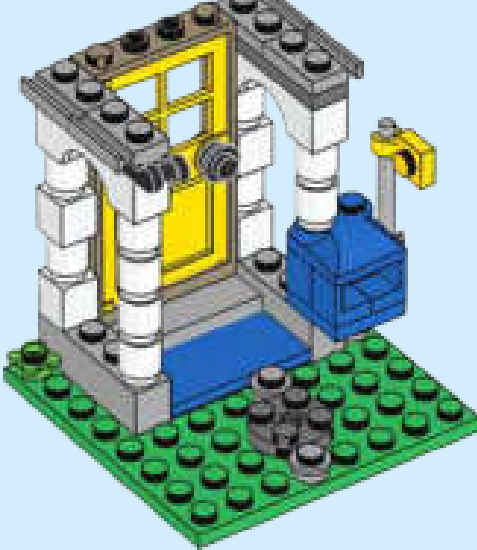

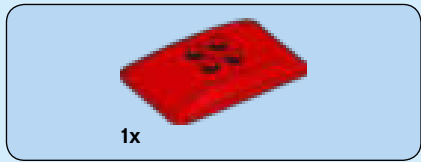

87

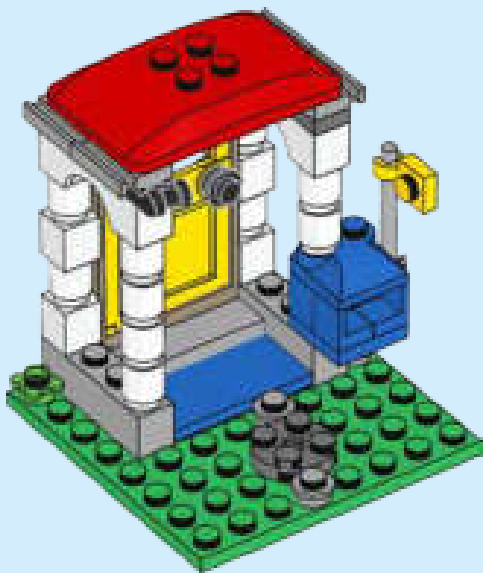

88

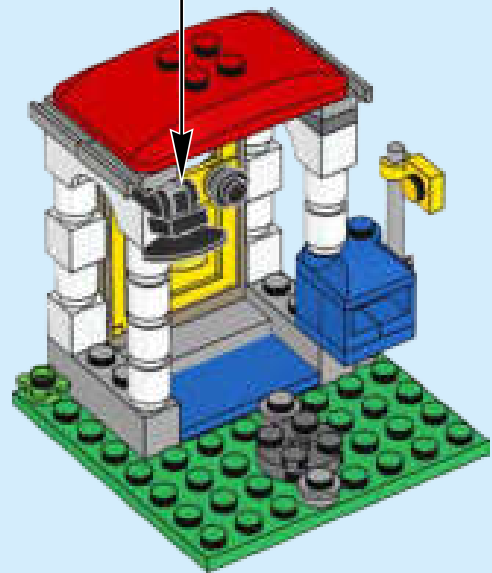
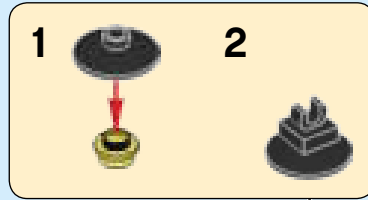

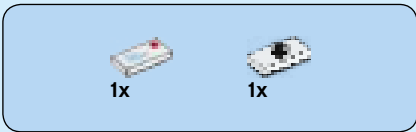

89

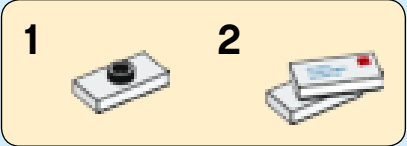
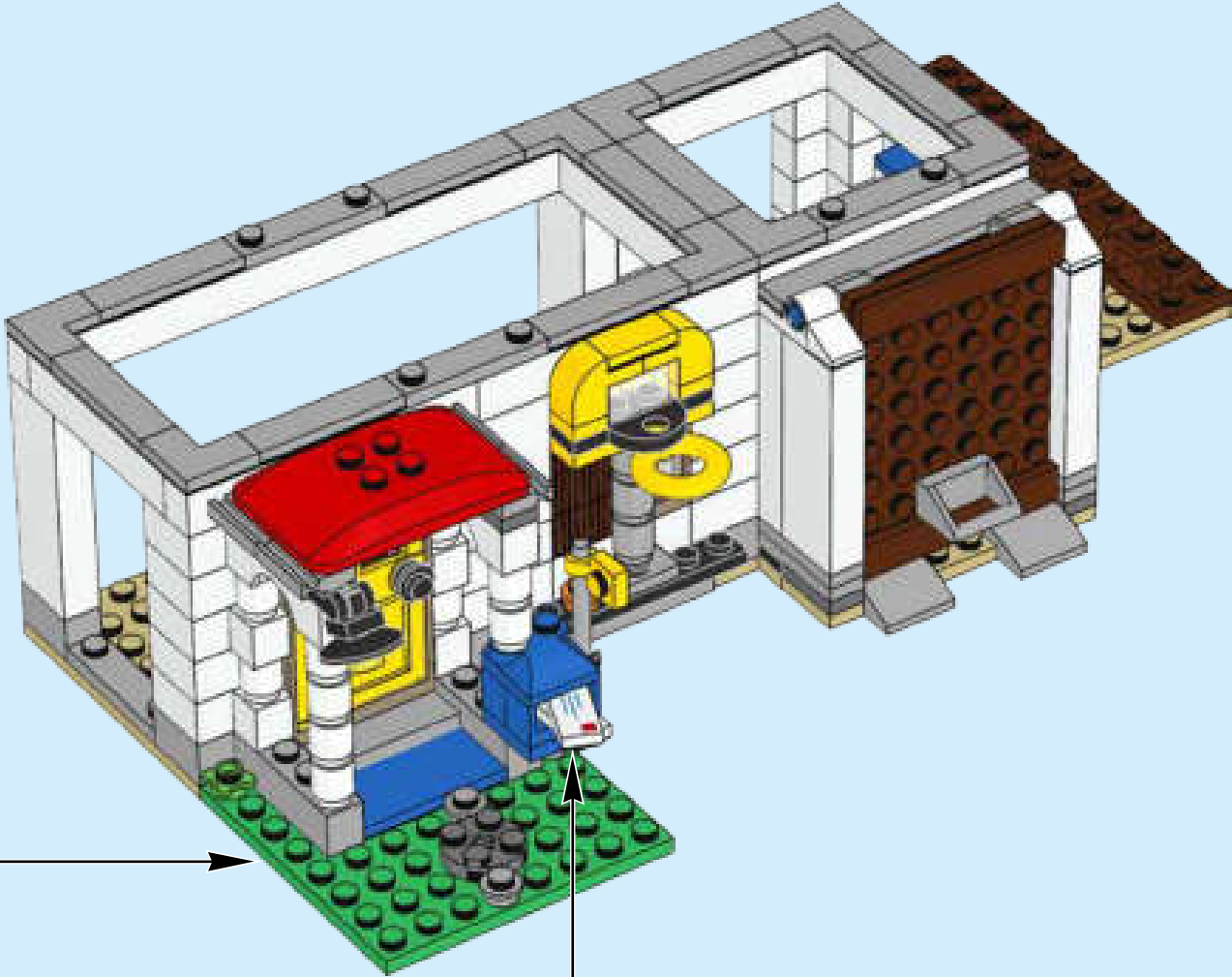

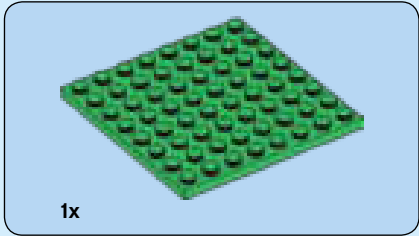

1x

90

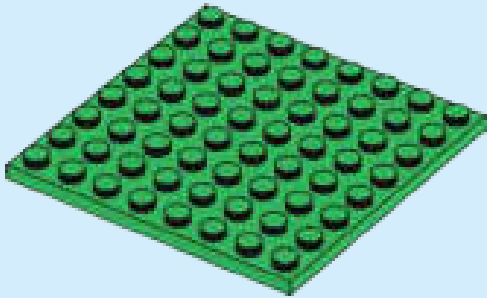

1x

2x

91

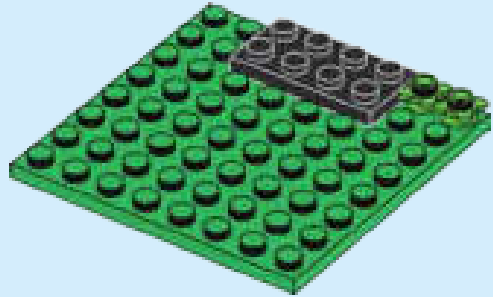

2x

92

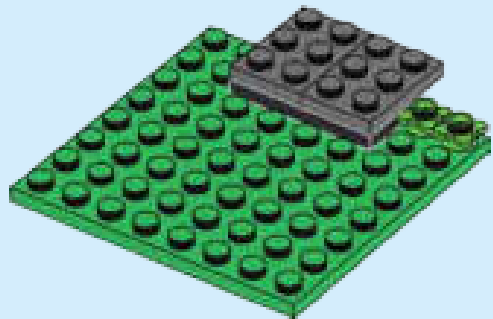



93

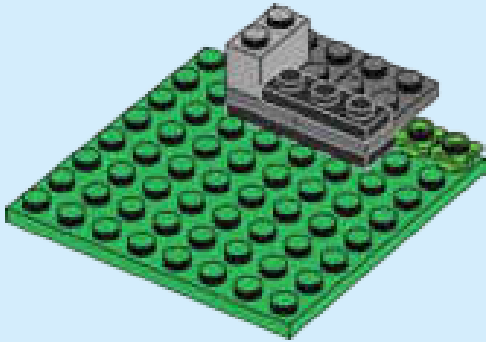

94

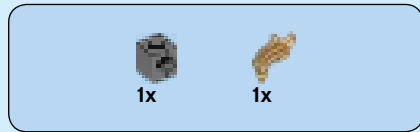
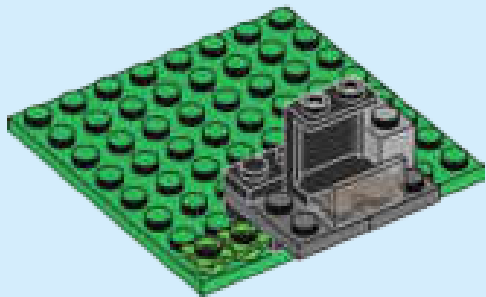
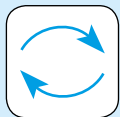

95

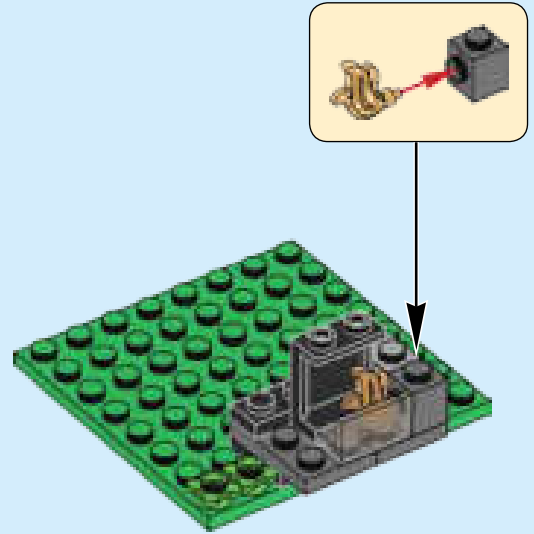

96

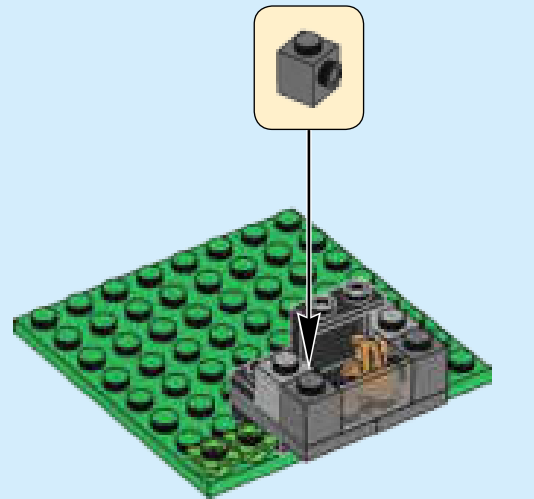

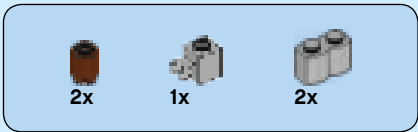

97

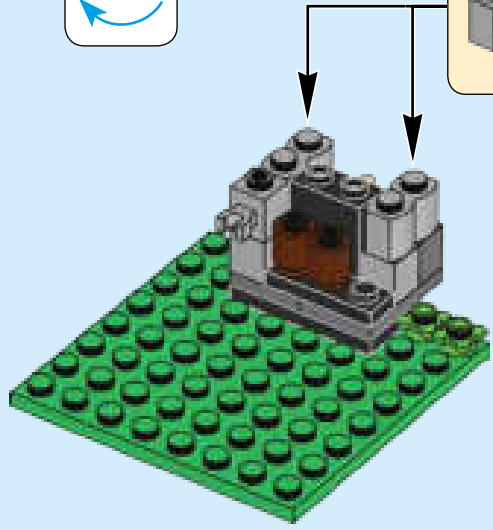
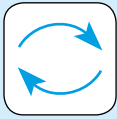

99

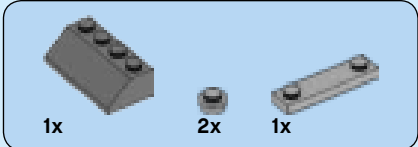
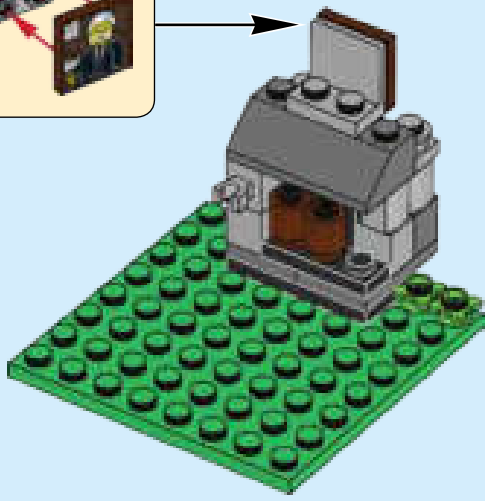
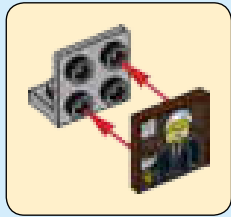

98

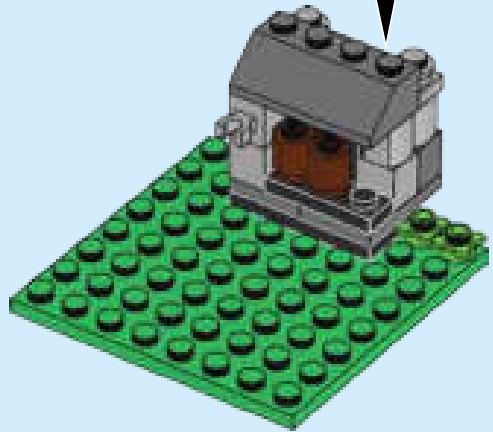
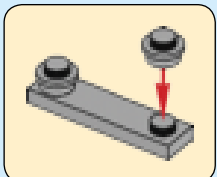

100





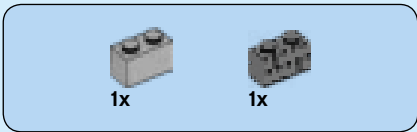

101

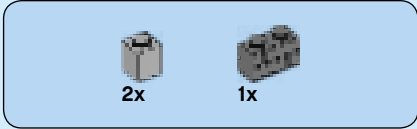
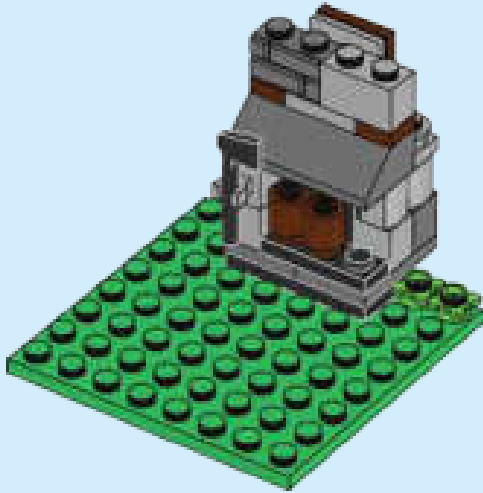

102

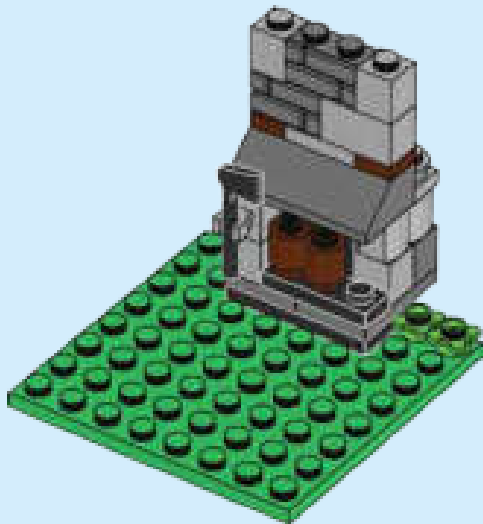

103

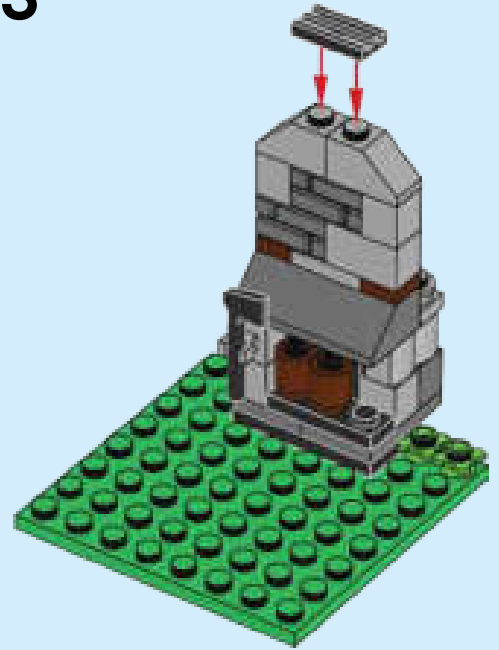

104

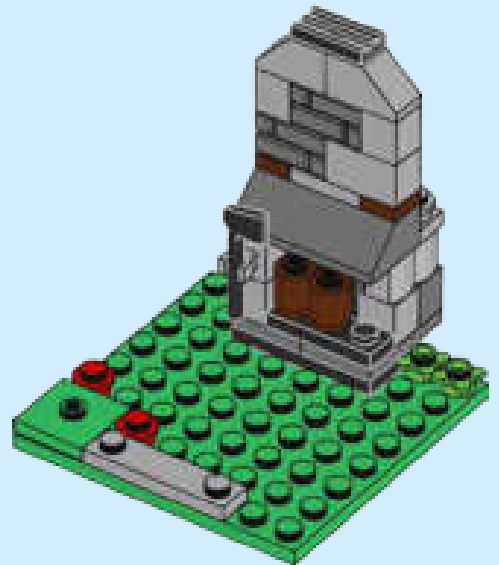



105

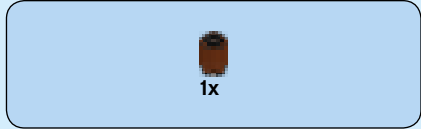

106

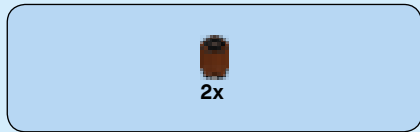

107



108

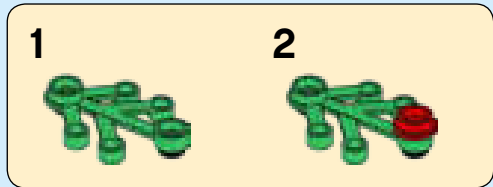



109

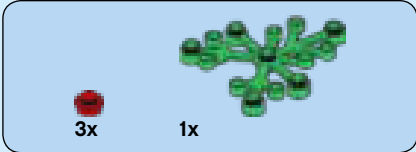

110

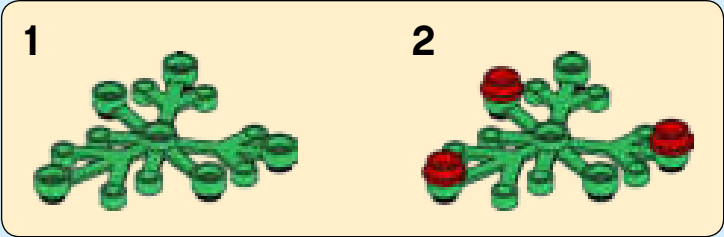

111

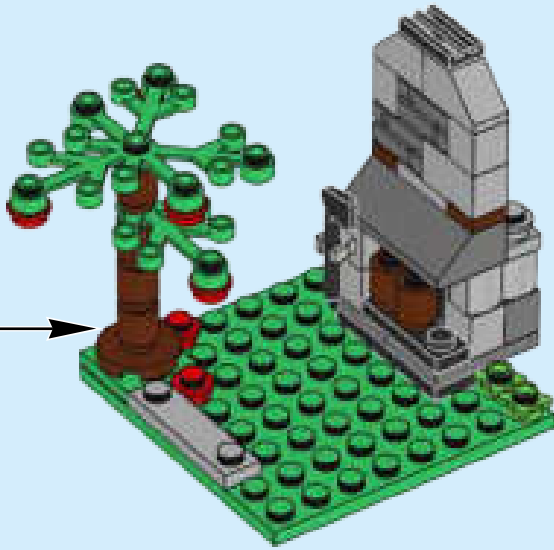

112

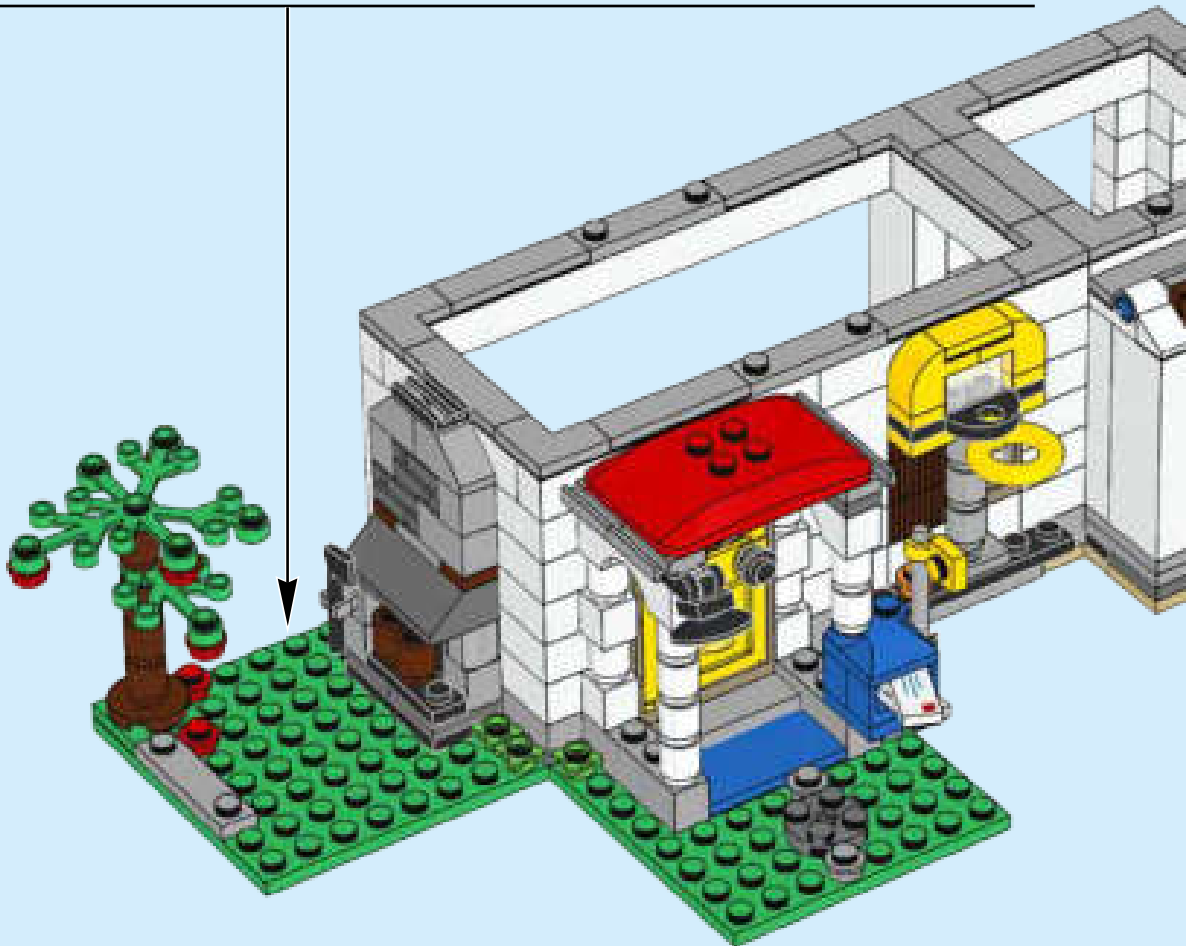

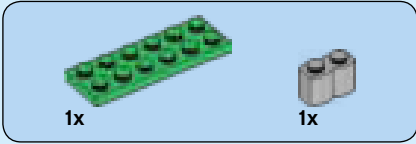

113

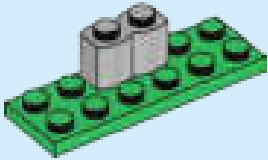

114

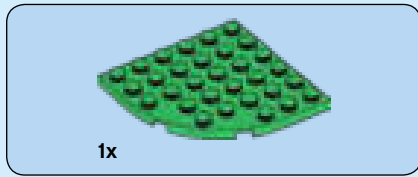
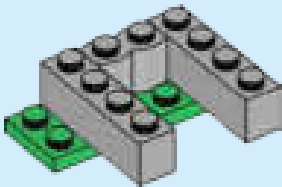

115

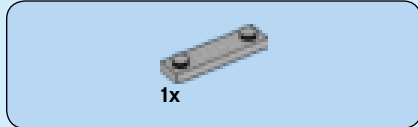
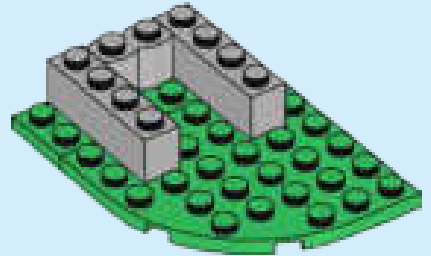

116

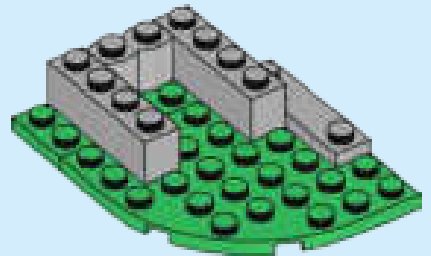

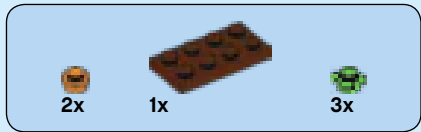

117

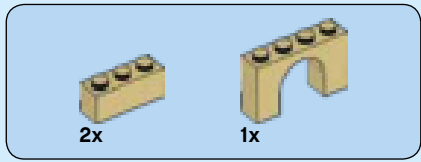
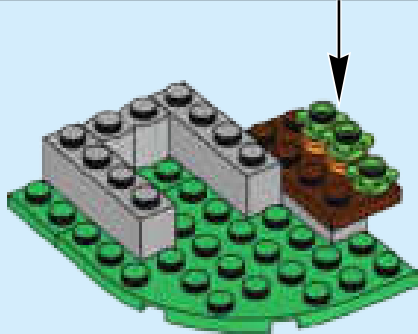

119

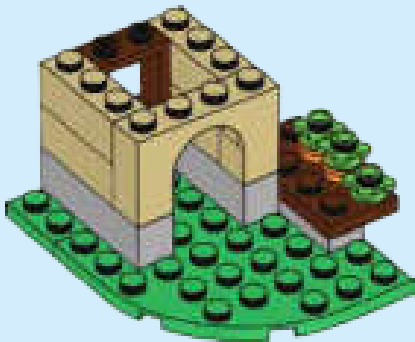

118

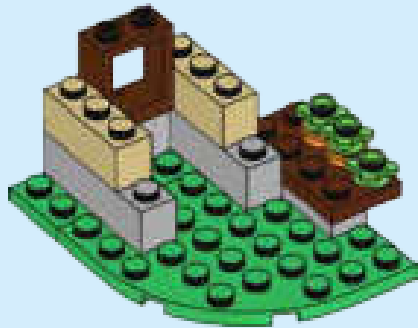

120

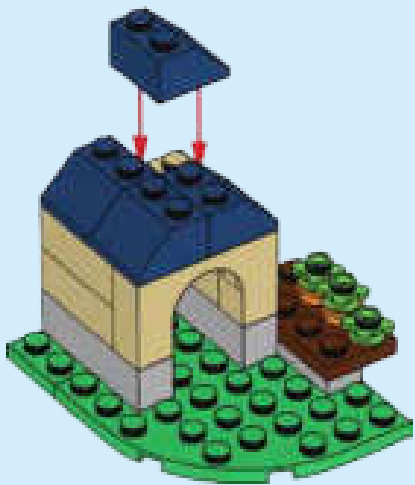



1x



1x

# 121

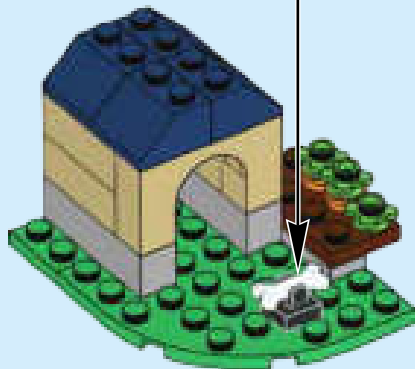
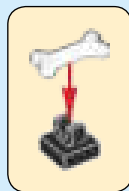

# 122

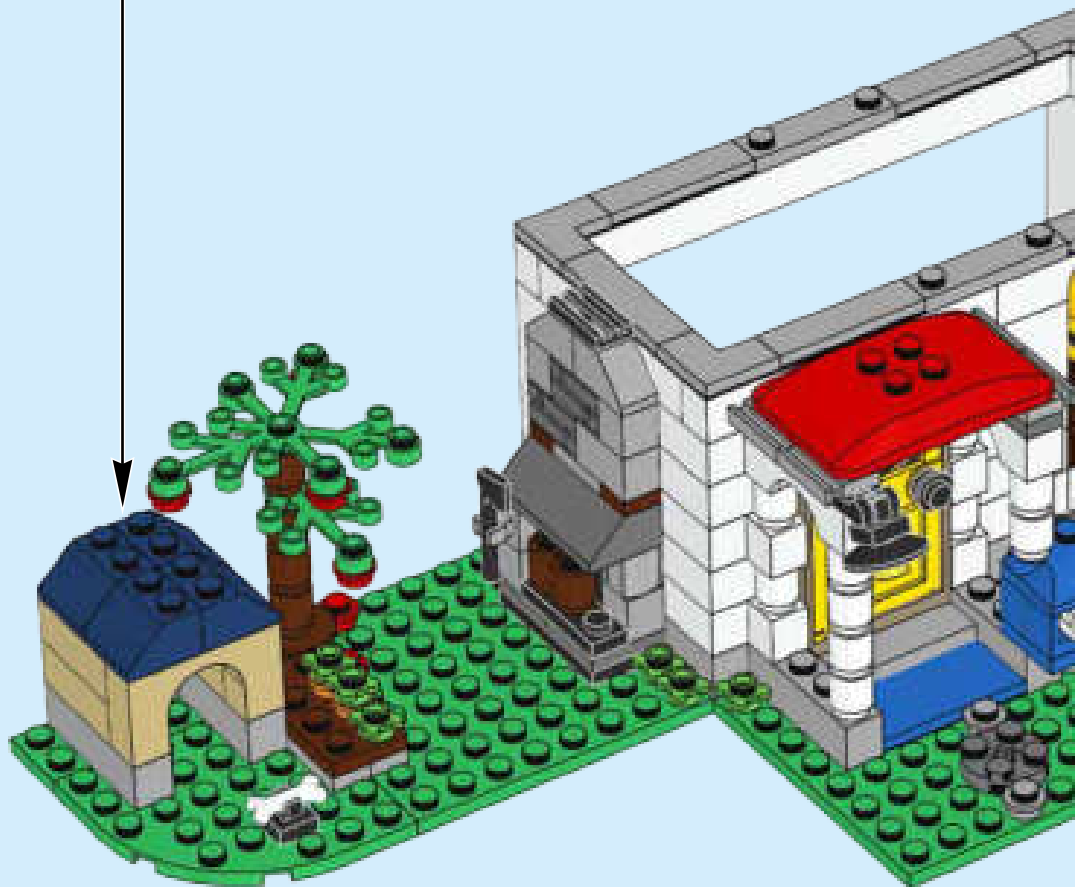

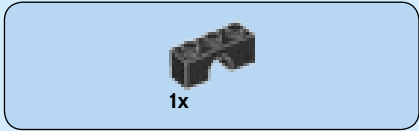

123

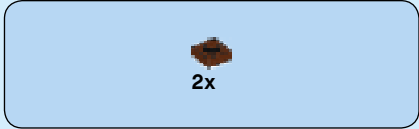

124

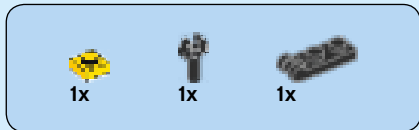

125

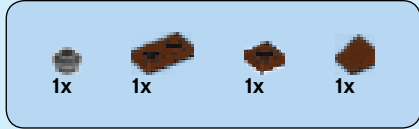
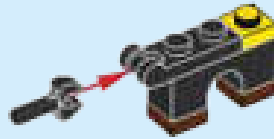

126

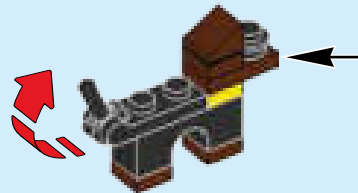



127

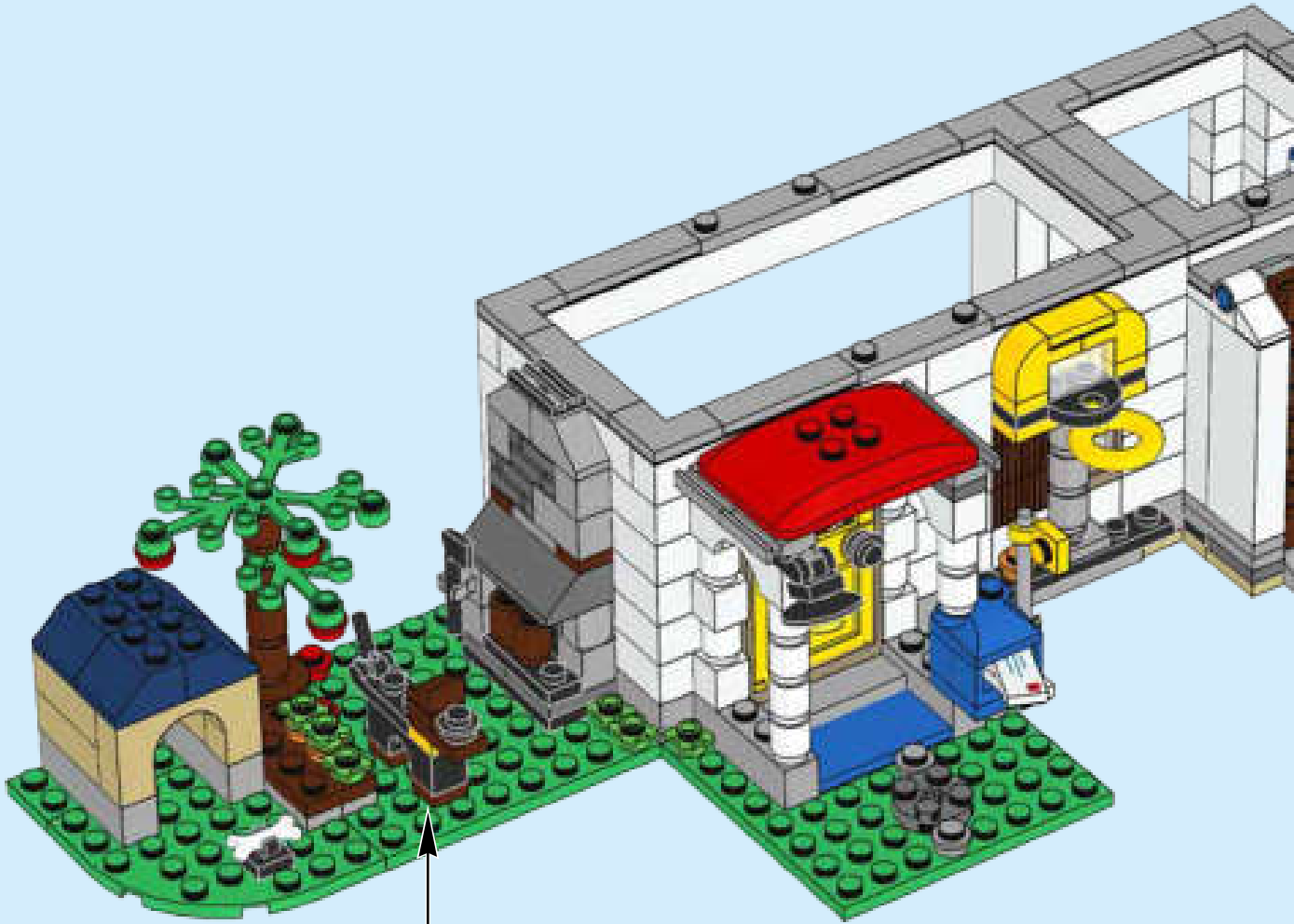

128

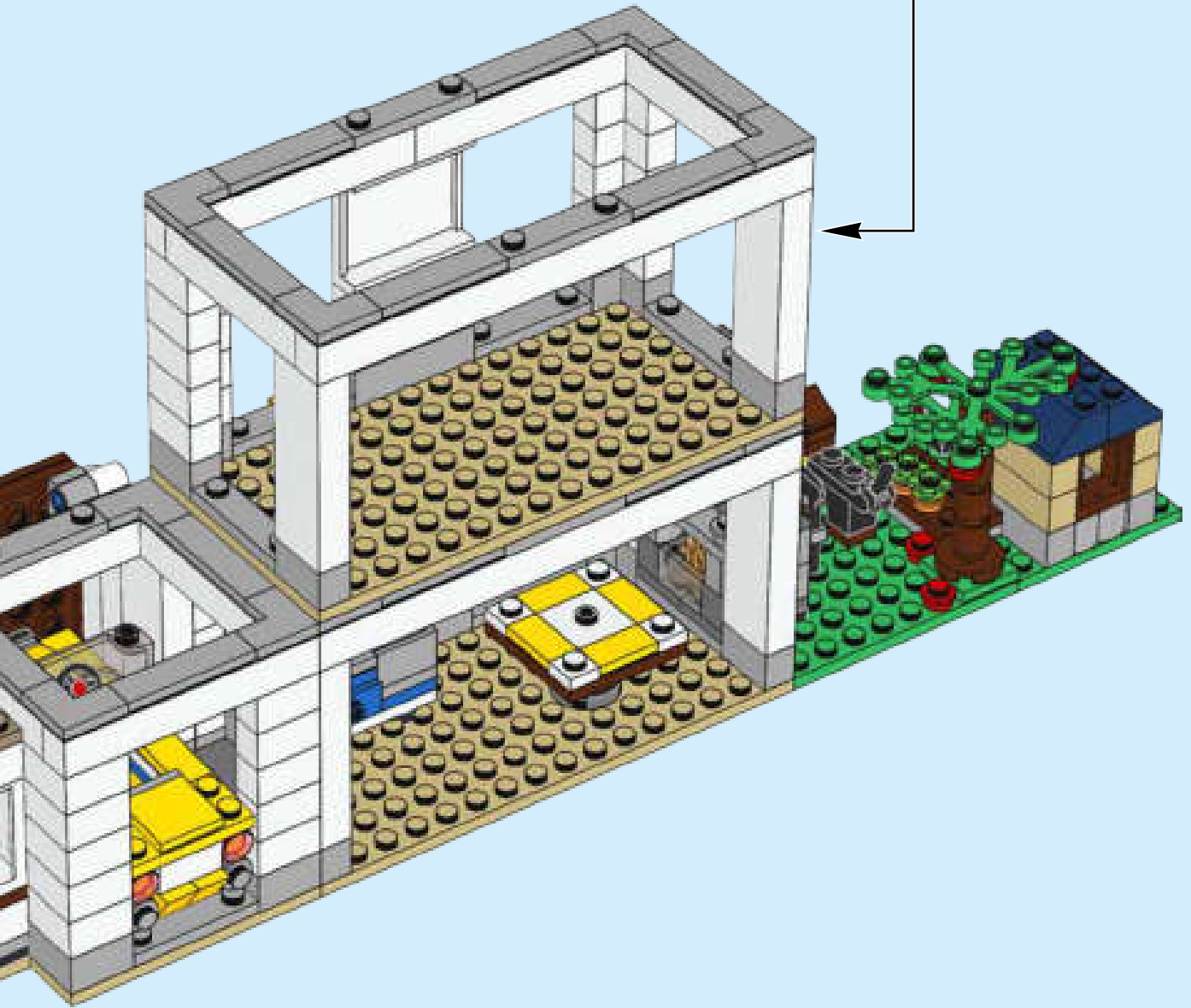
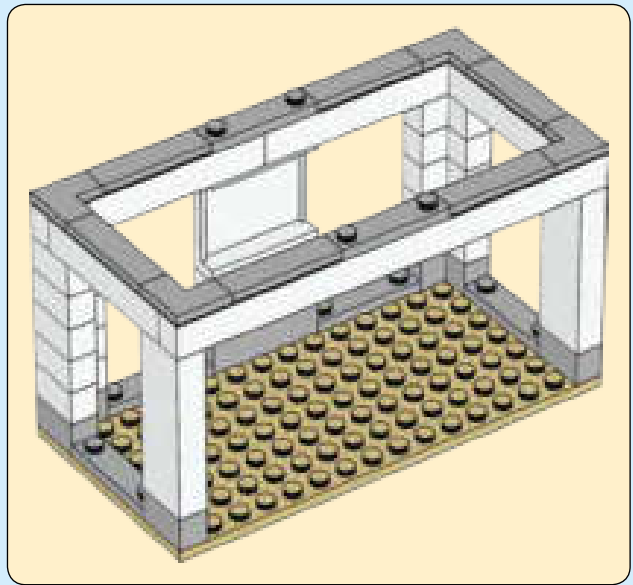

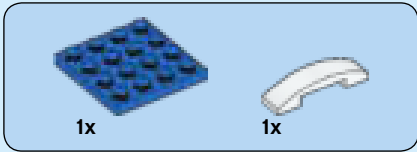

**129**

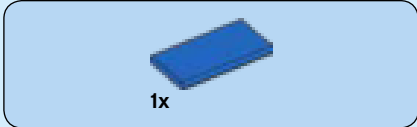

**130**

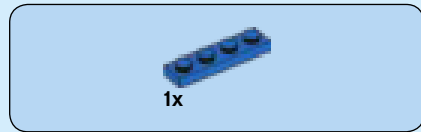
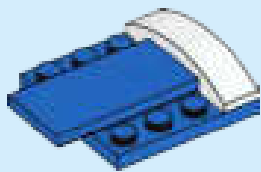

**131**

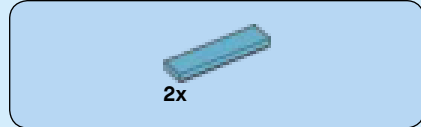
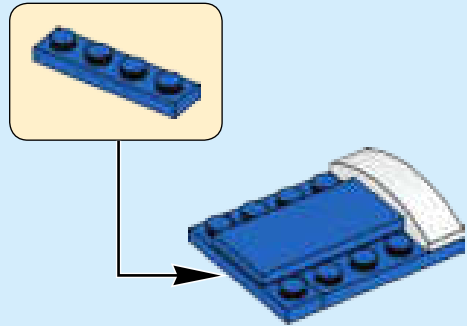

**132**

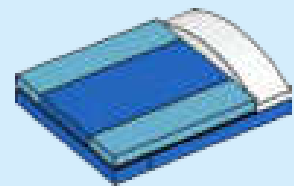



2x

133

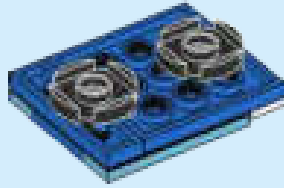
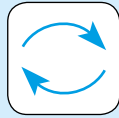

134





135

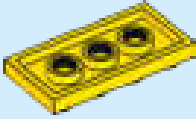

136

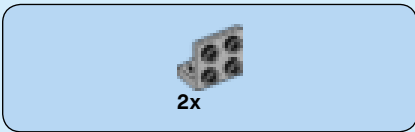

137

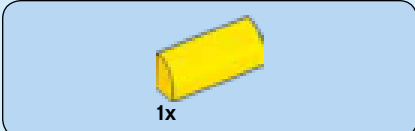
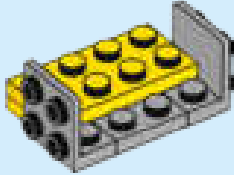
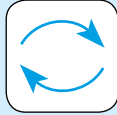

138

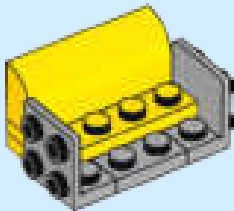



139

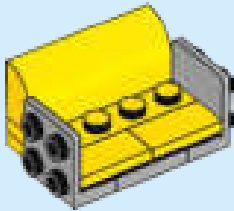

140

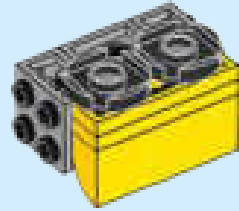
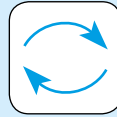

141

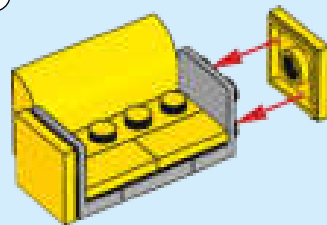
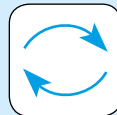

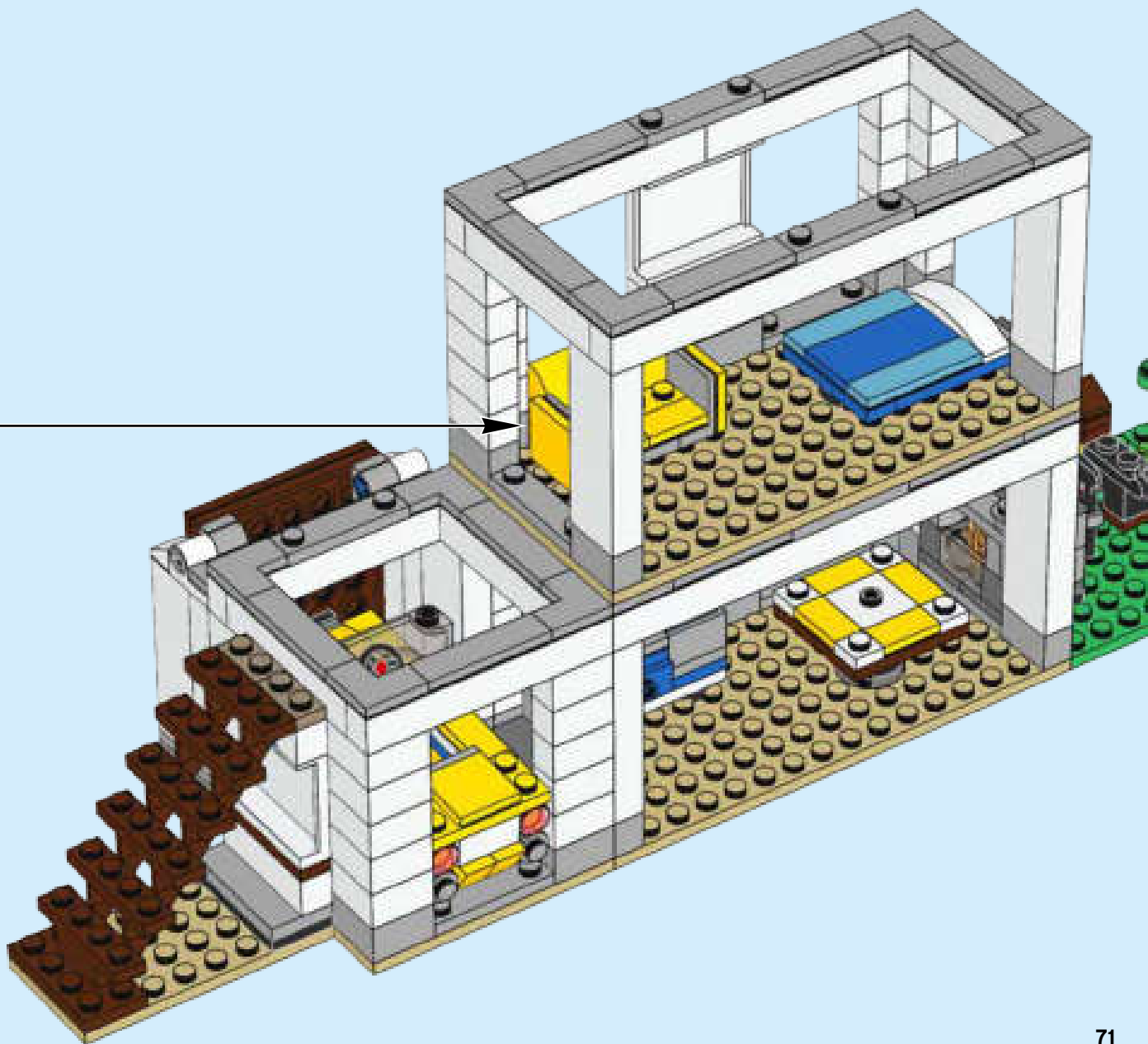

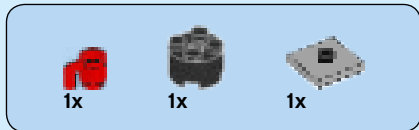

# 143

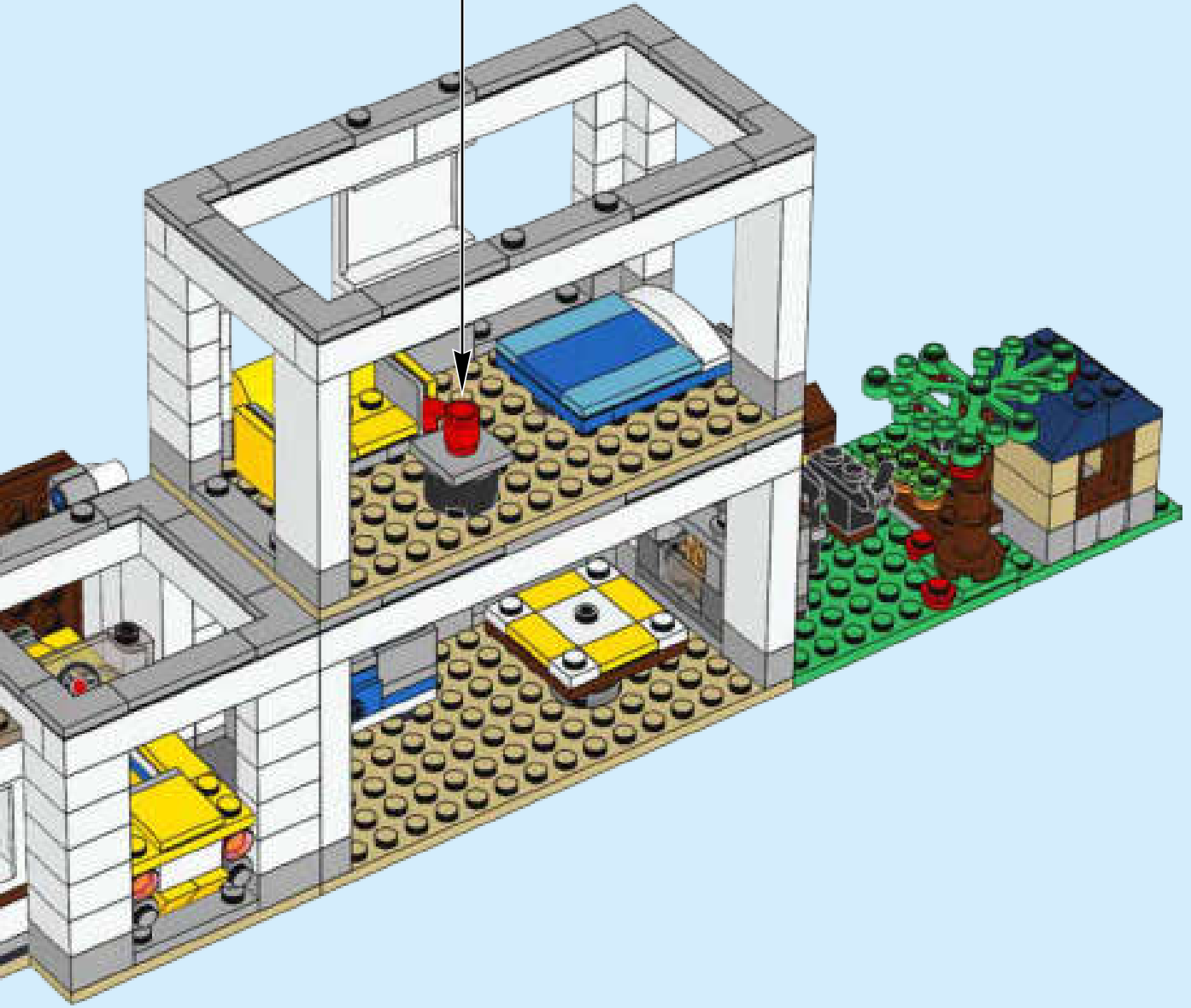
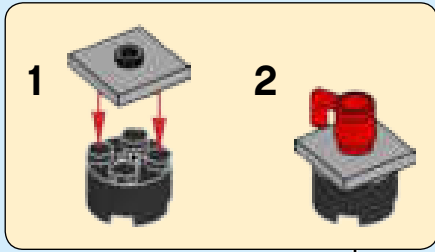



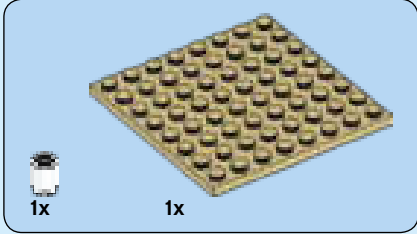

144



145

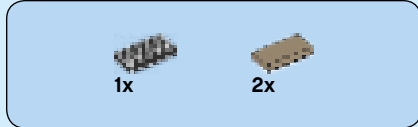
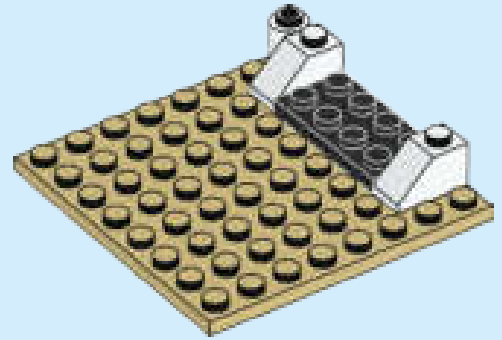

146

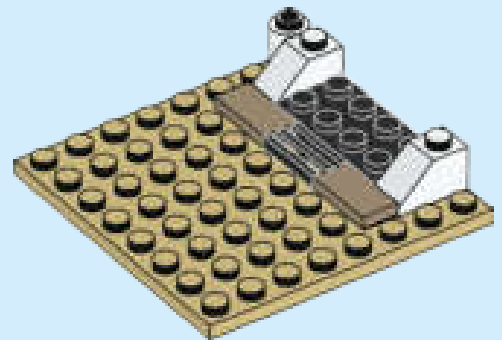

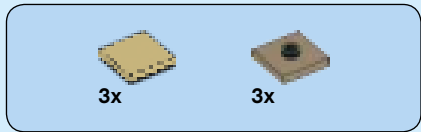

147

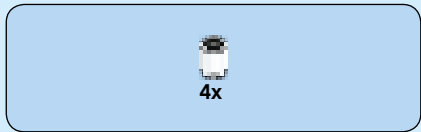
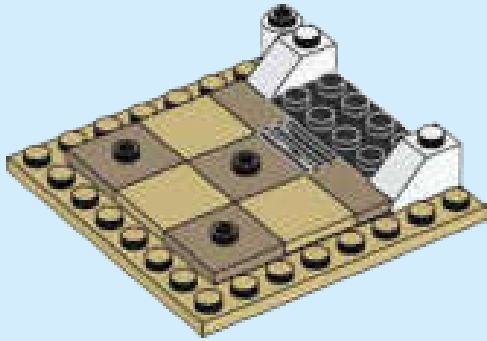

148

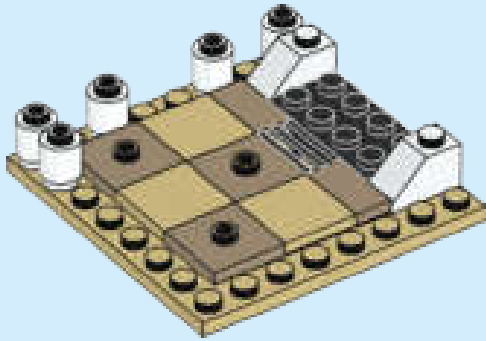

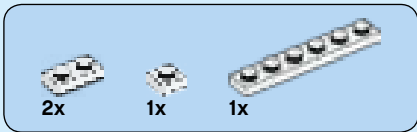

149

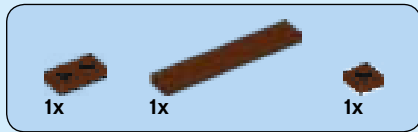
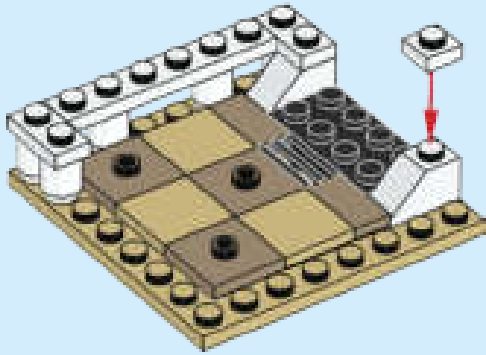

150

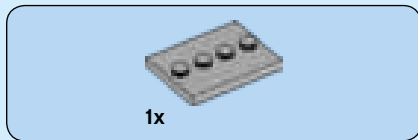
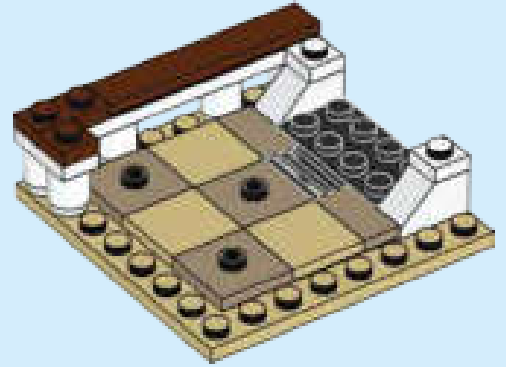

151

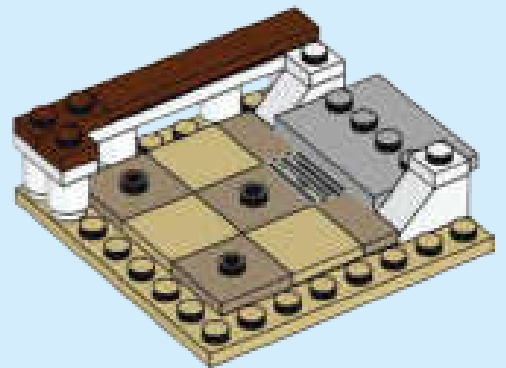

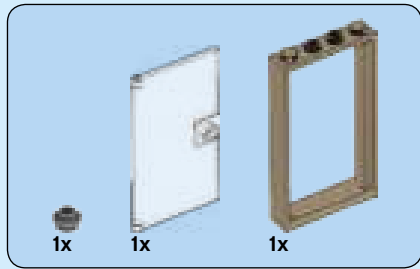

# 152

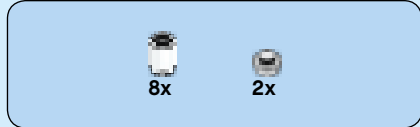
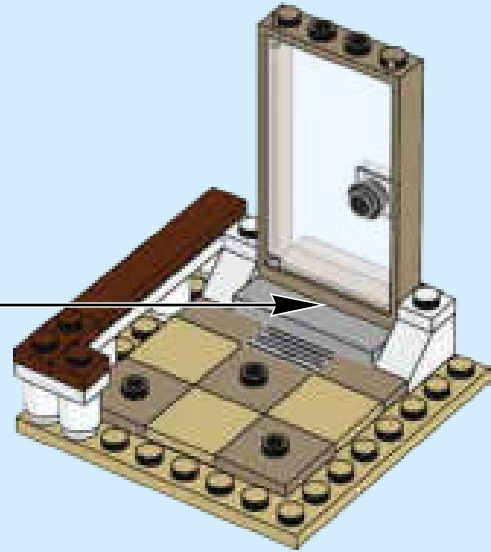
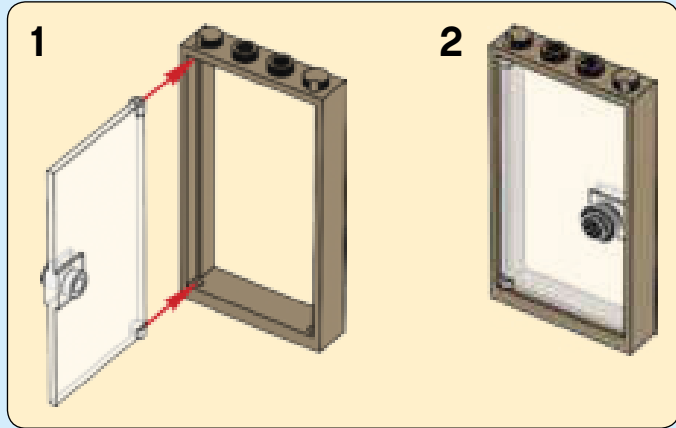

# 153

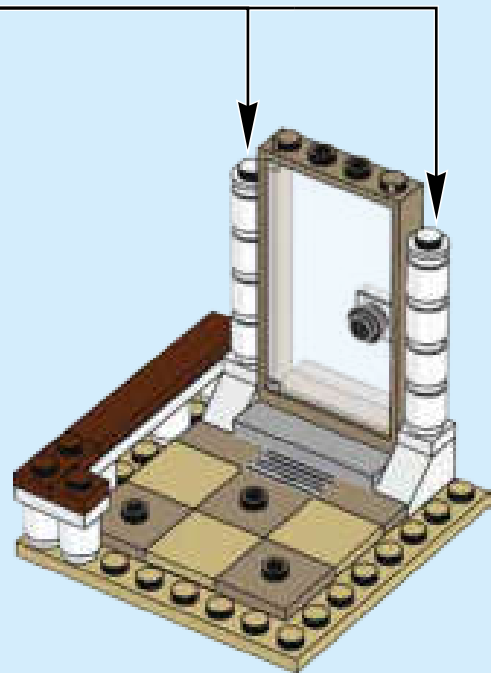

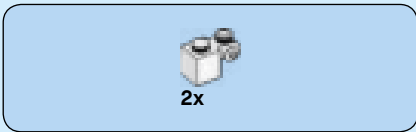

# 154

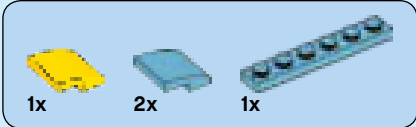
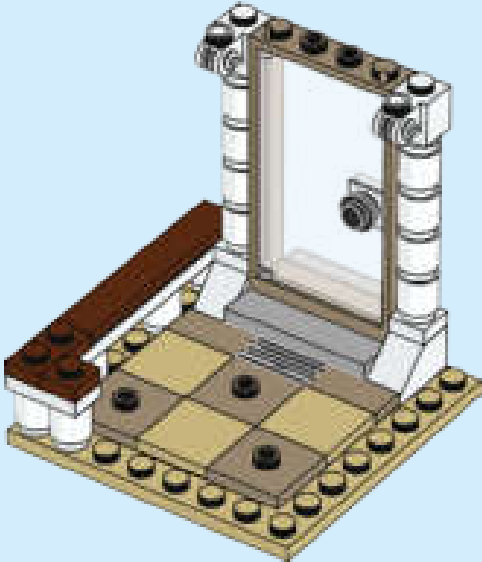

# 155

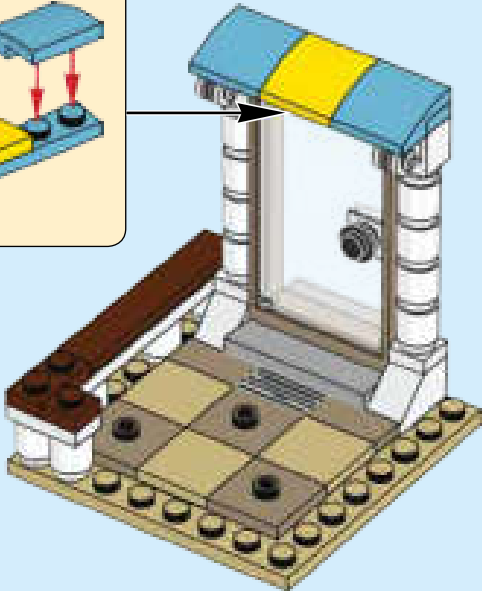
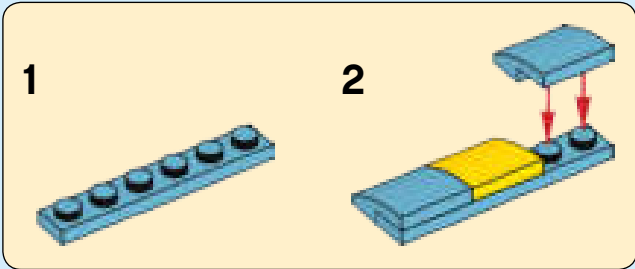



# 156

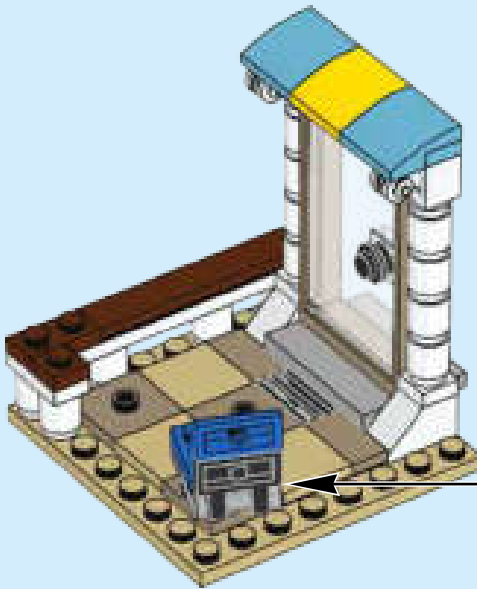
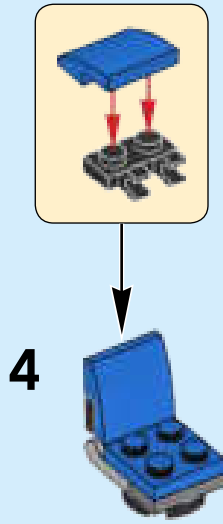
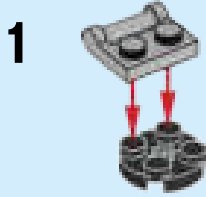

157

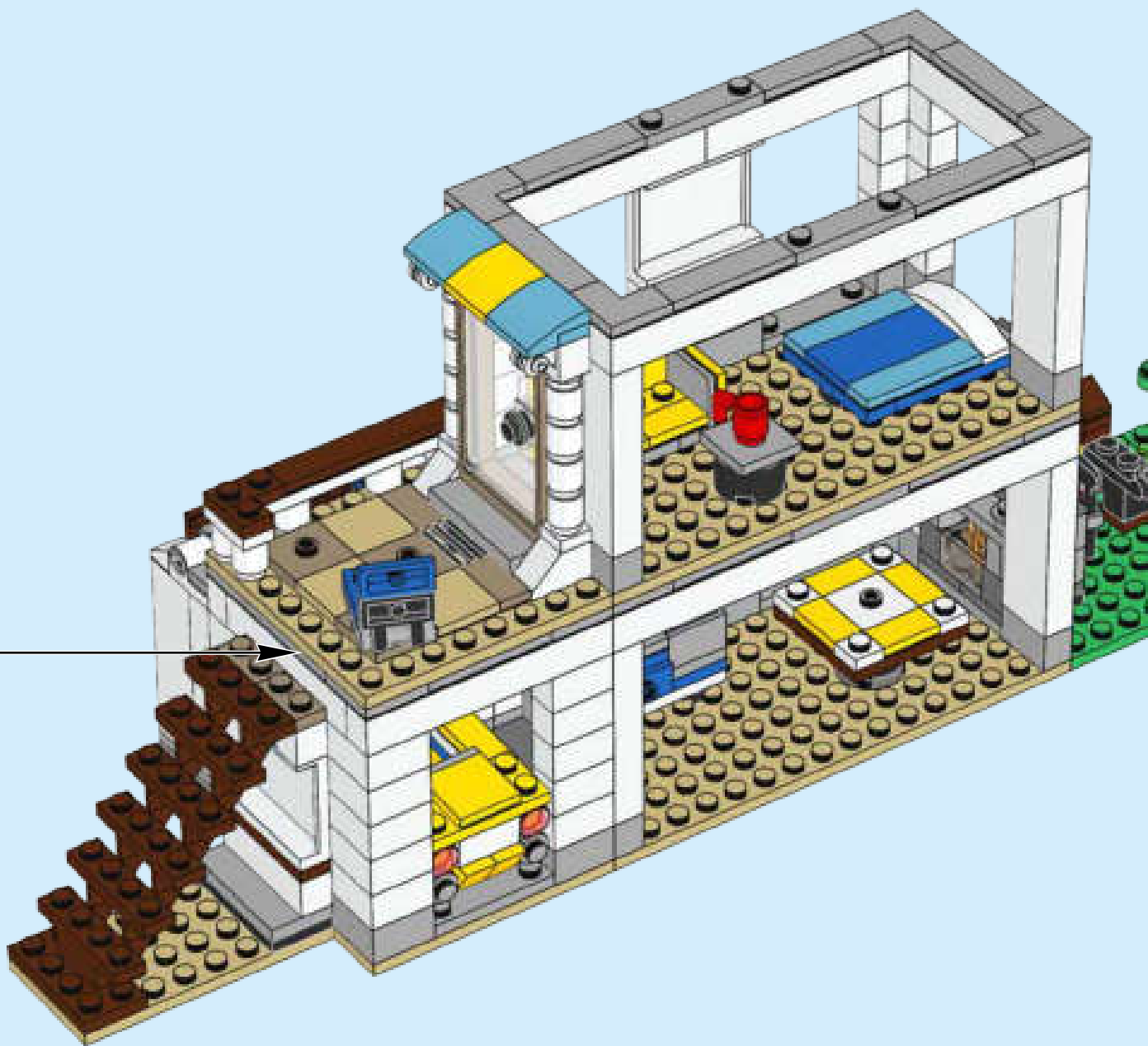

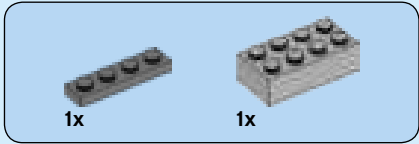

158

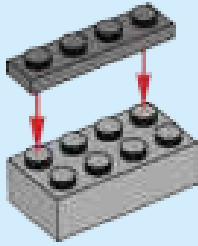

159

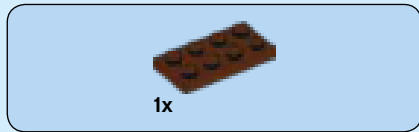
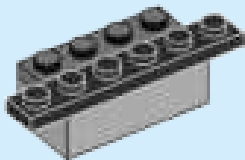

160

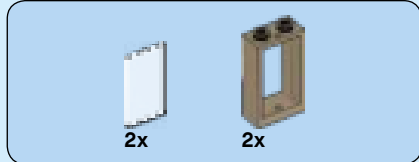
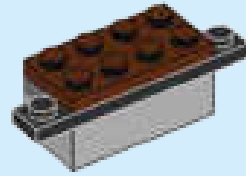

161

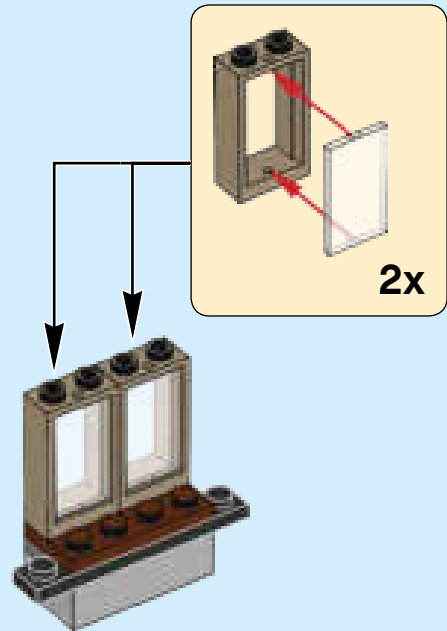





2x



2x

# 162

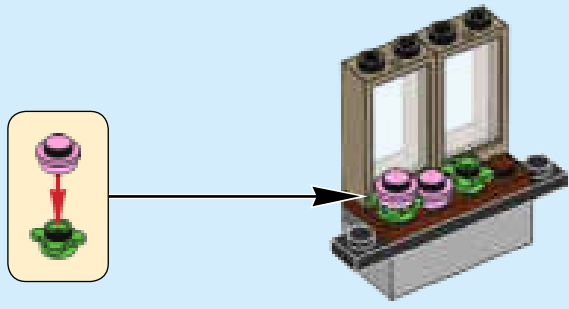

# 163

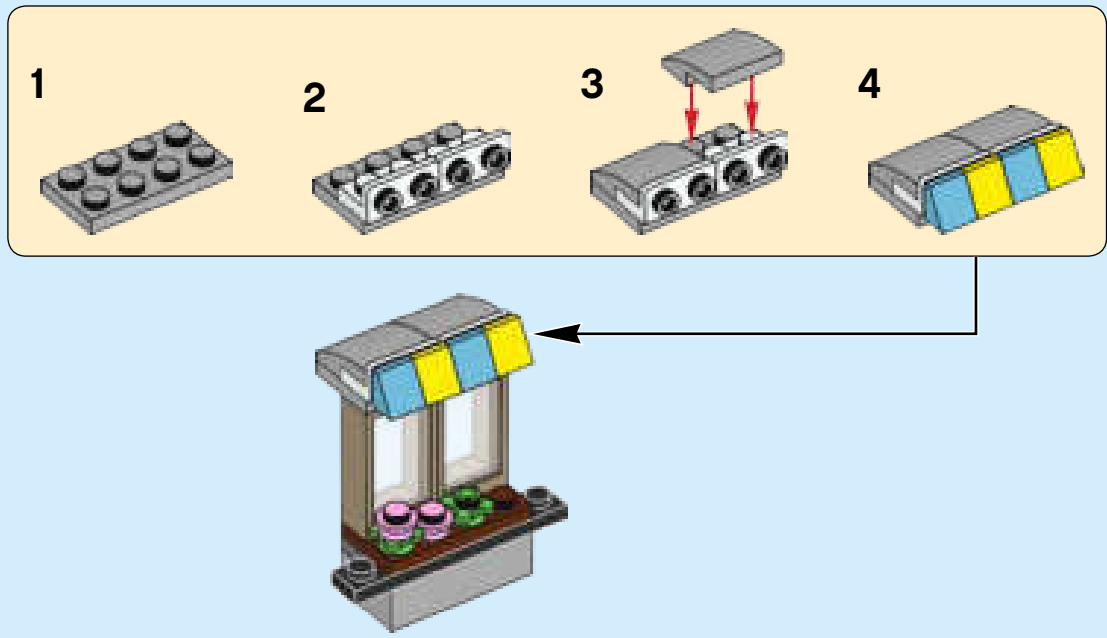

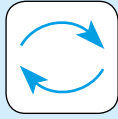

164

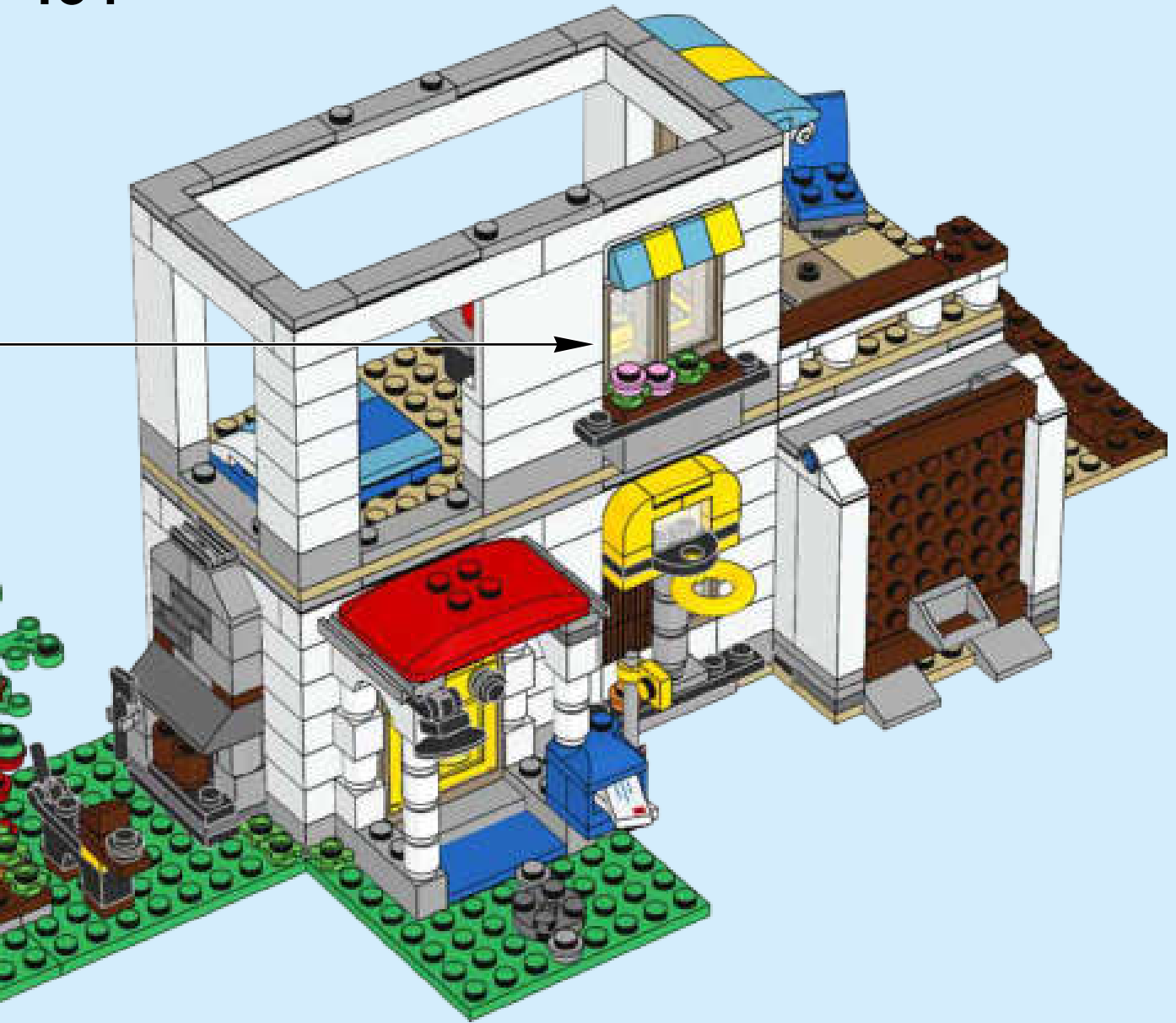

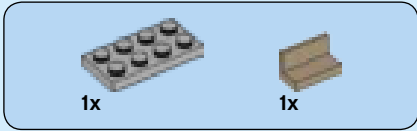

**165**

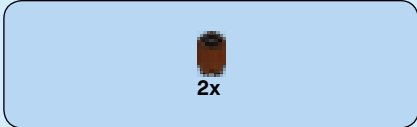
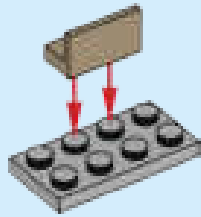

**166**

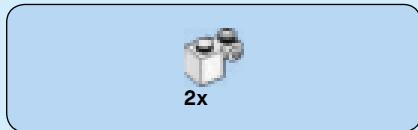
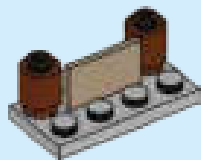

**167**



**168**

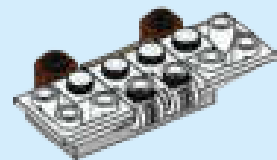

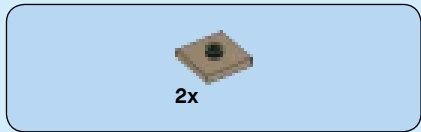

169

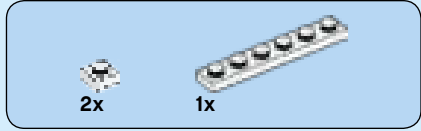
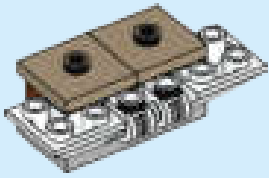

170

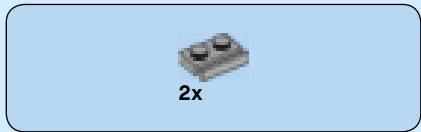
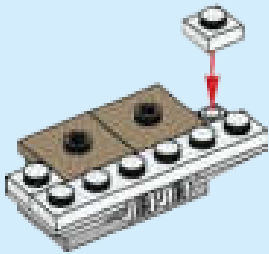

171

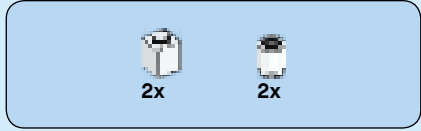
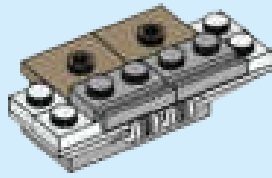

172



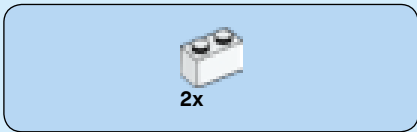

173

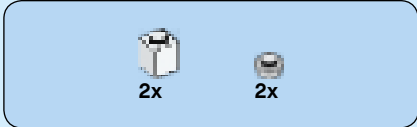
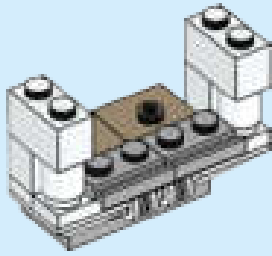

174

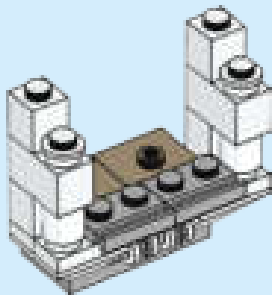

175

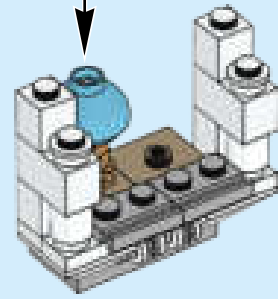

176

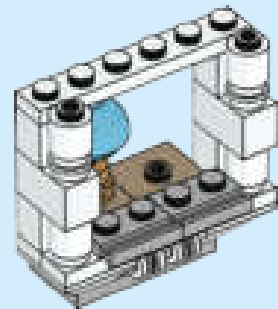

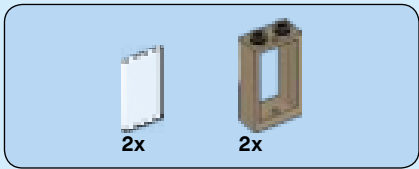

177

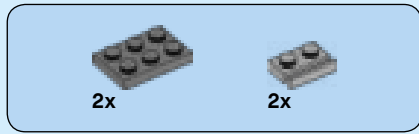
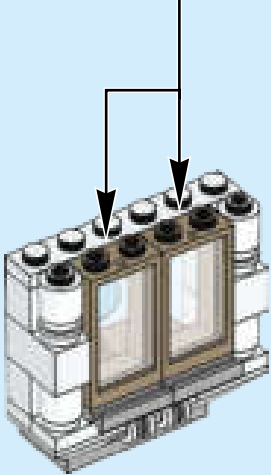
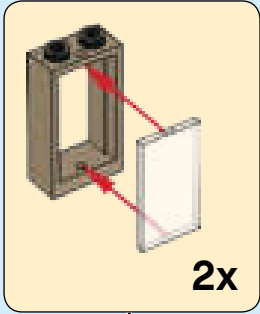

178

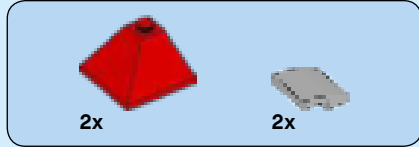
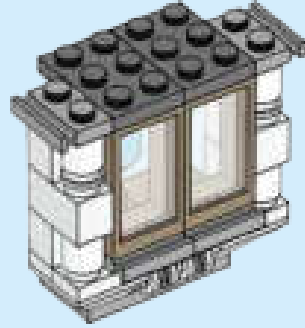

179

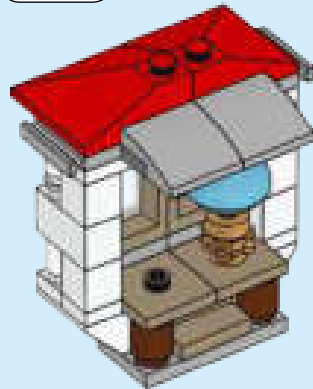
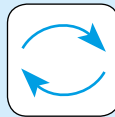

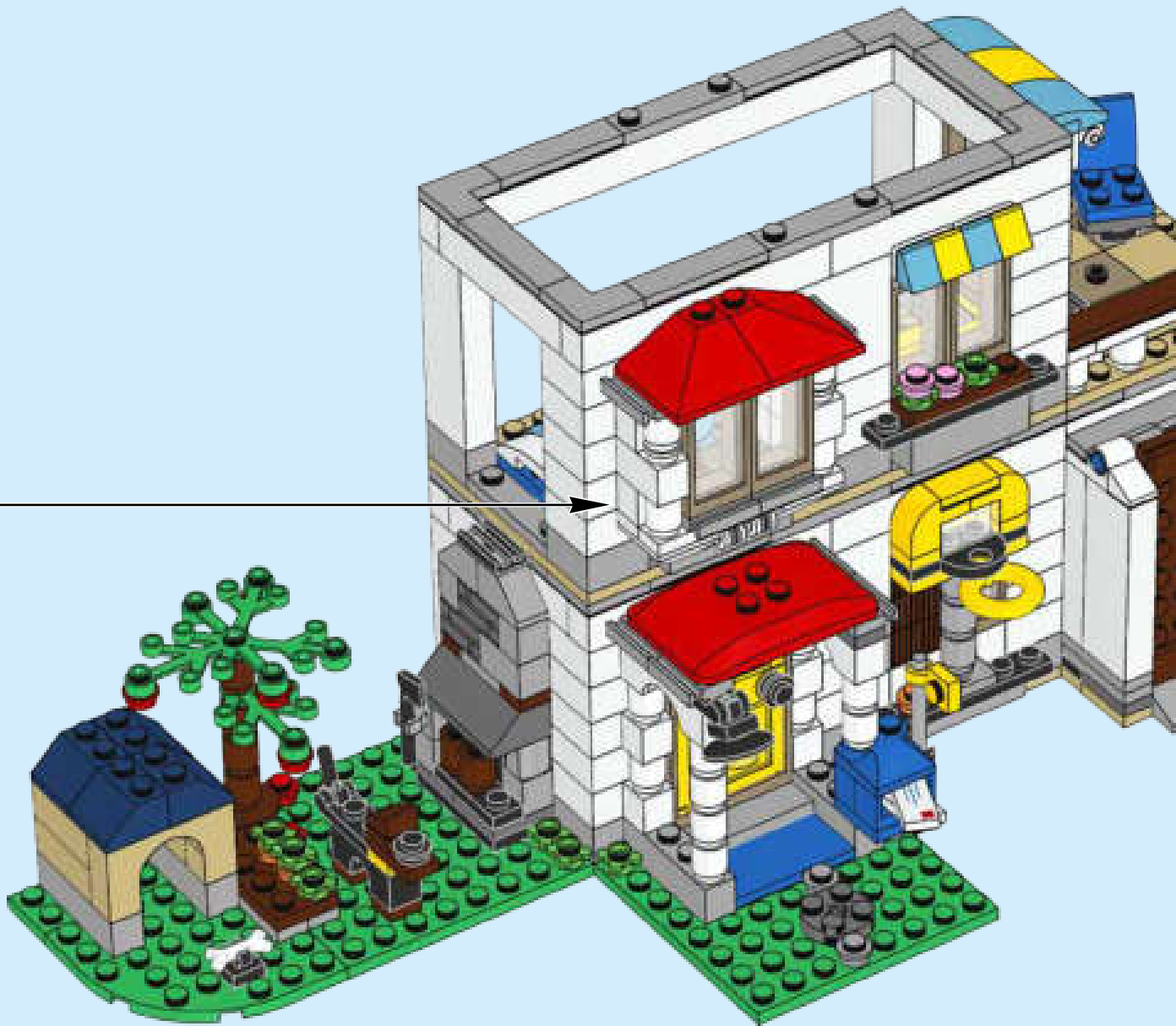

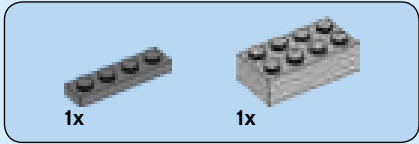

181

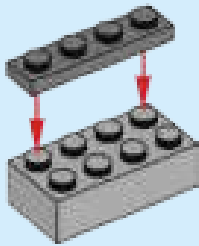

182

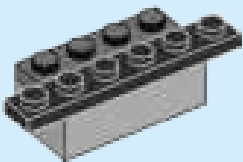

183

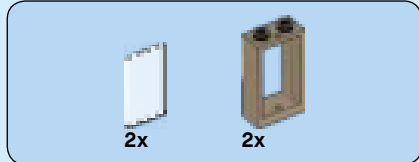

184

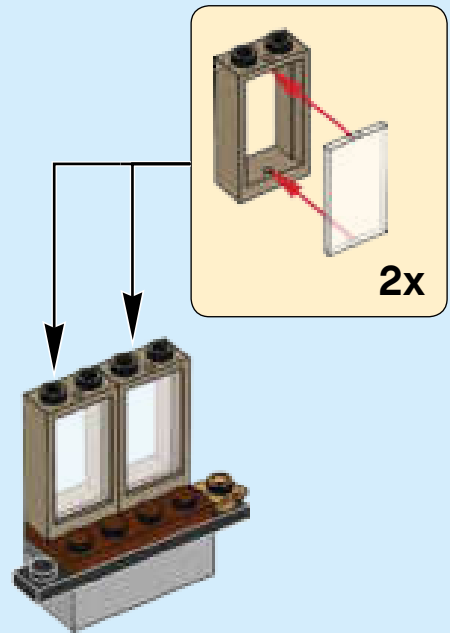



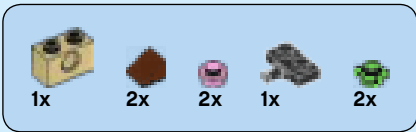

# 185

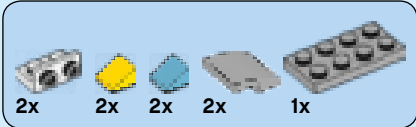
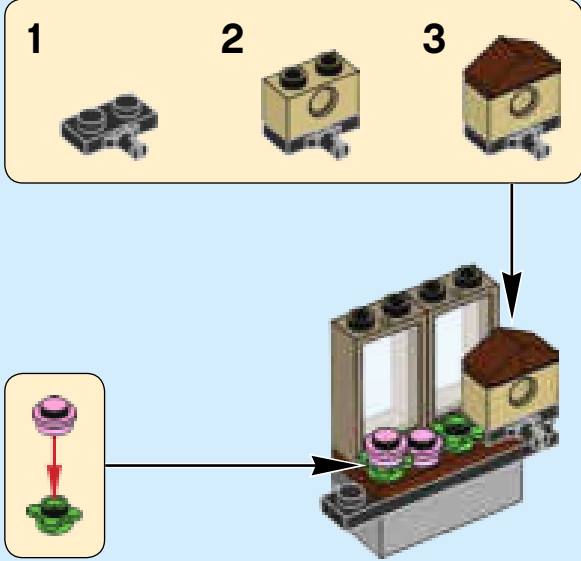

# 186

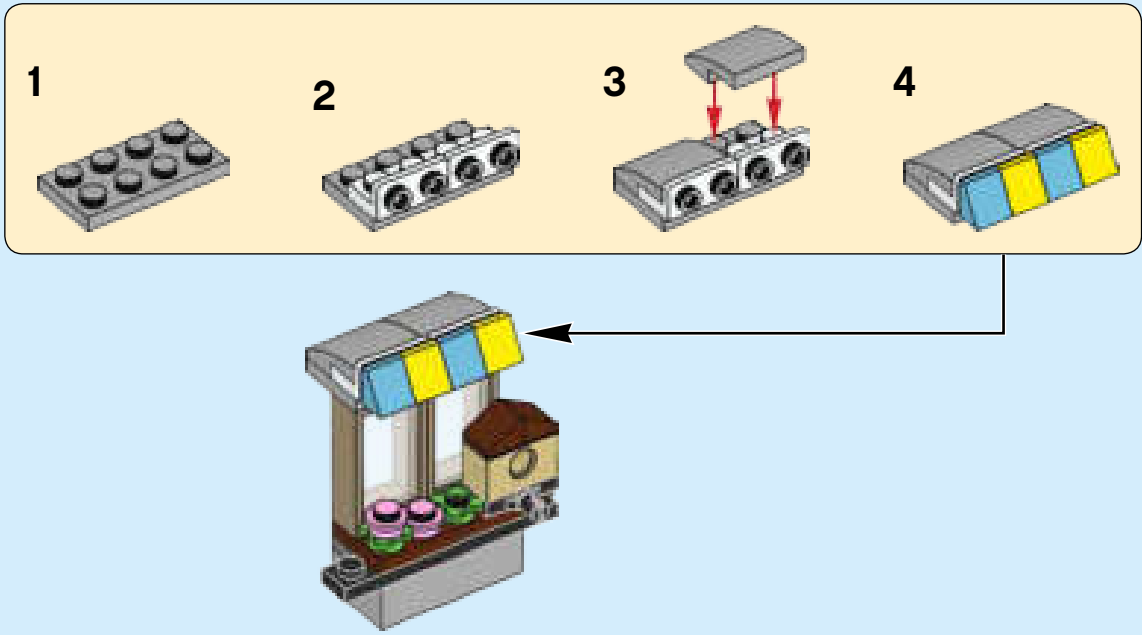

187



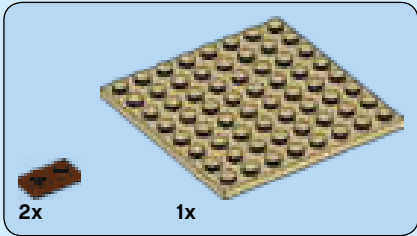
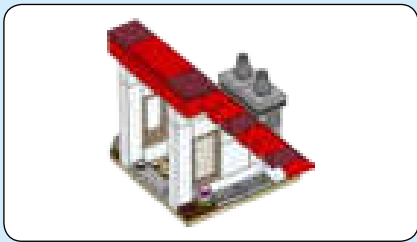

188



189

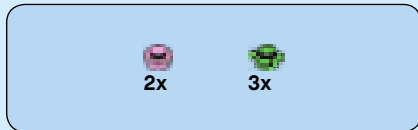
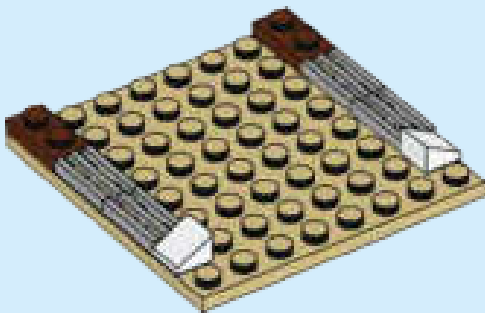

190

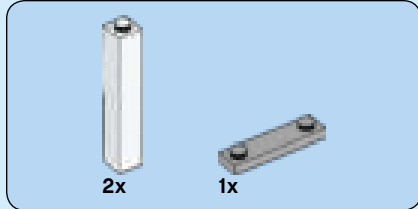
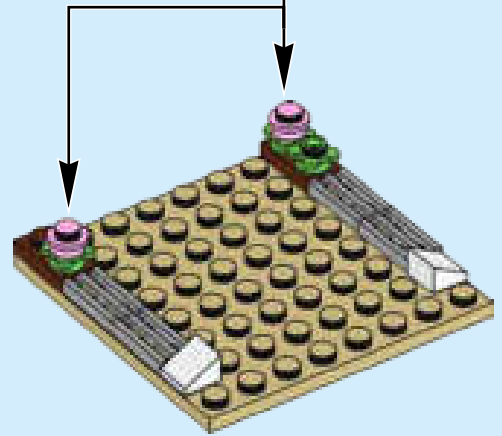
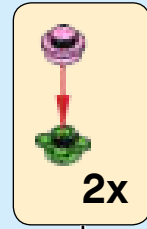

191

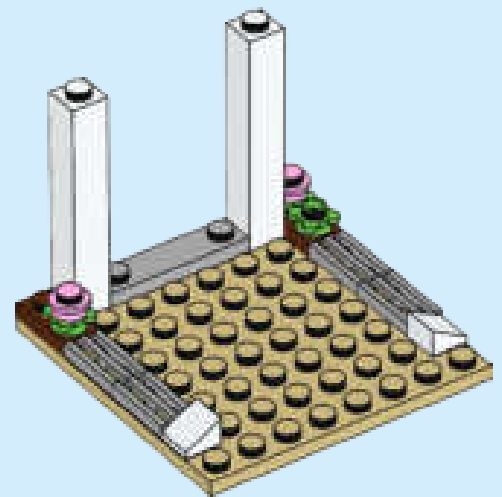

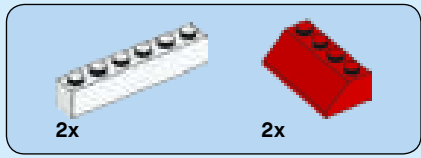

192

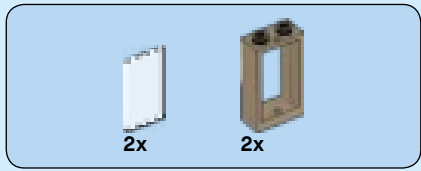
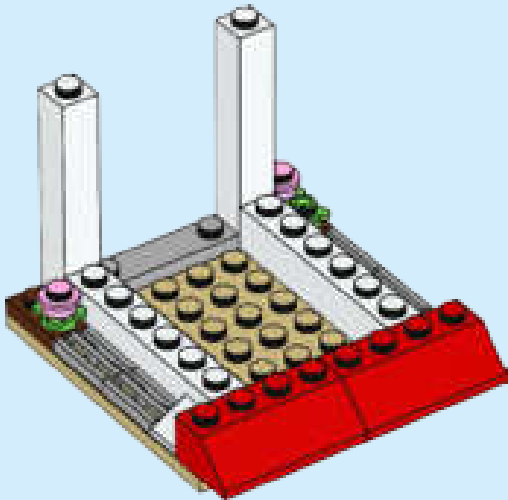

193

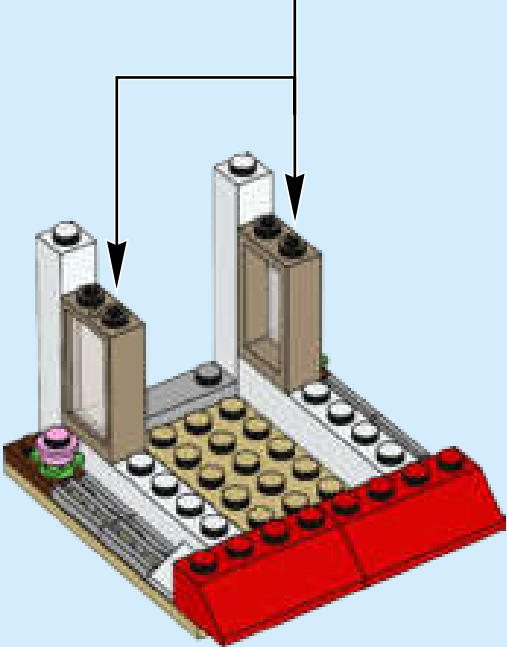
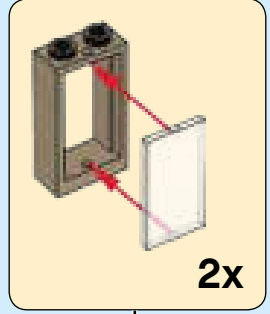

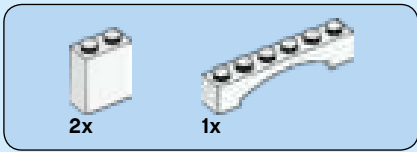

194

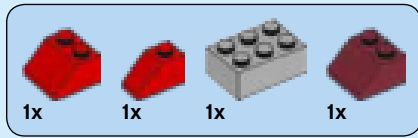
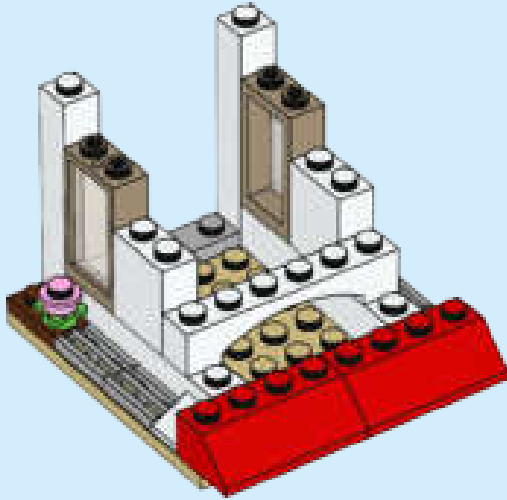

196

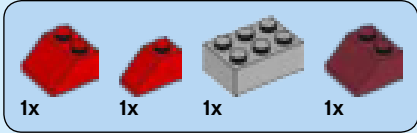
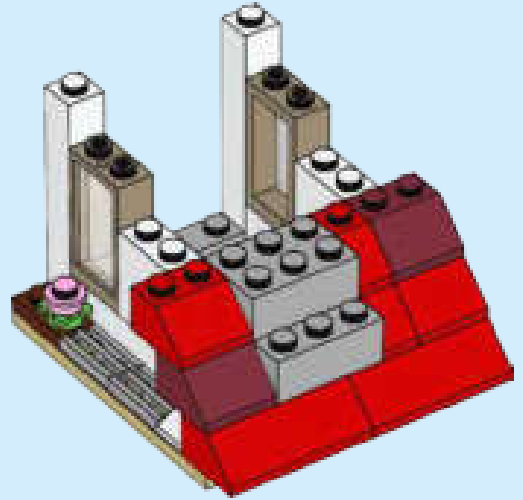

195

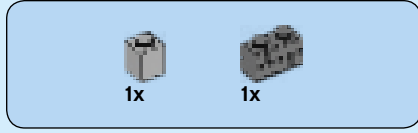
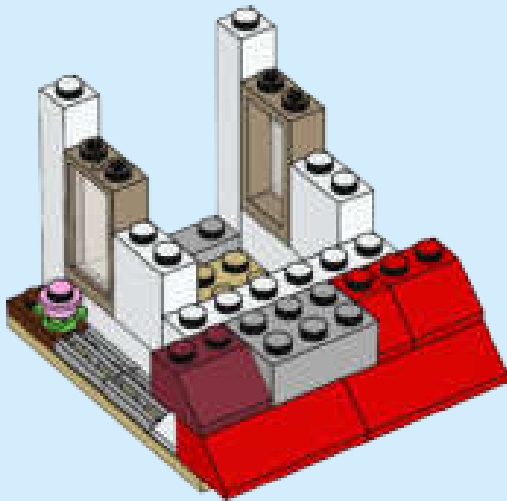

197

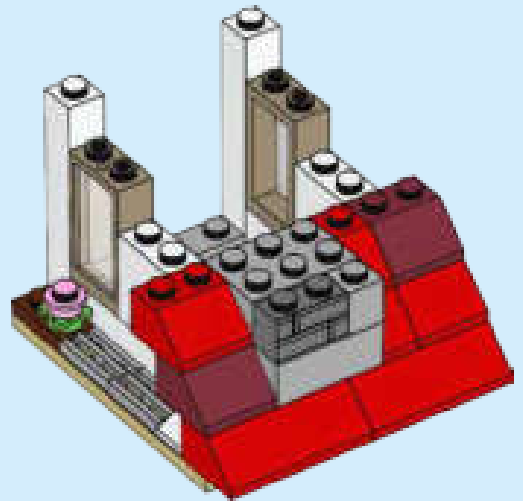

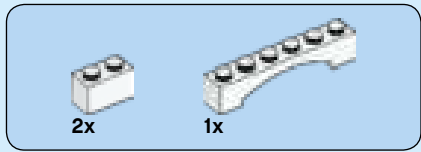

198

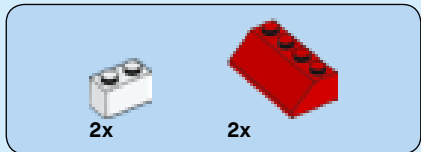
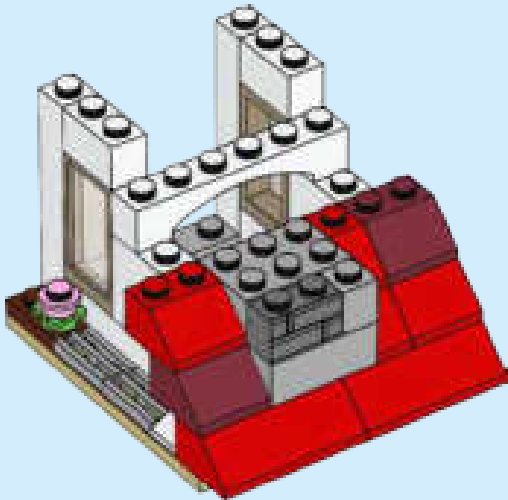

199

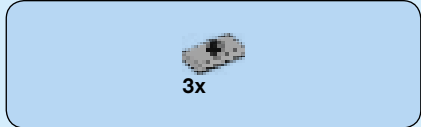
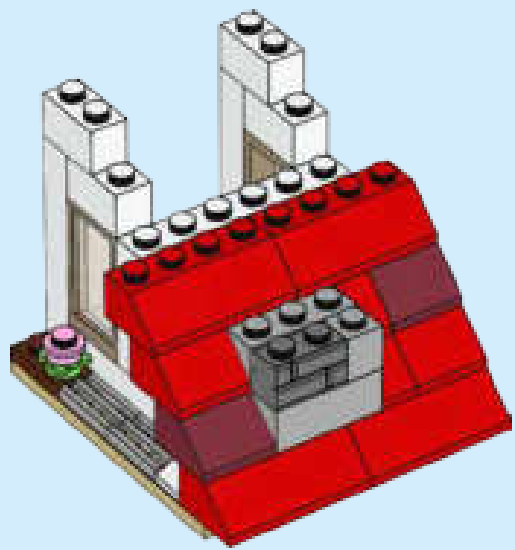

200

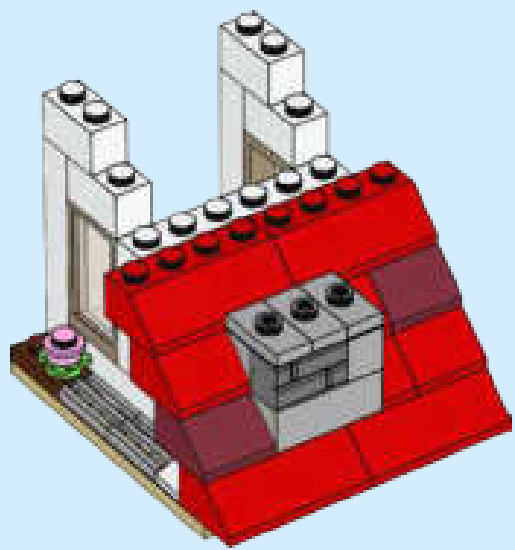

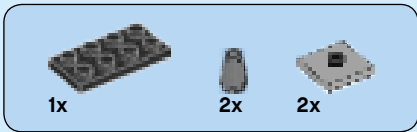

201

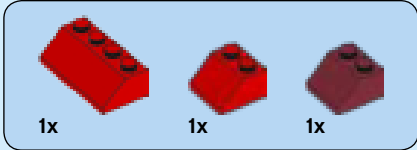
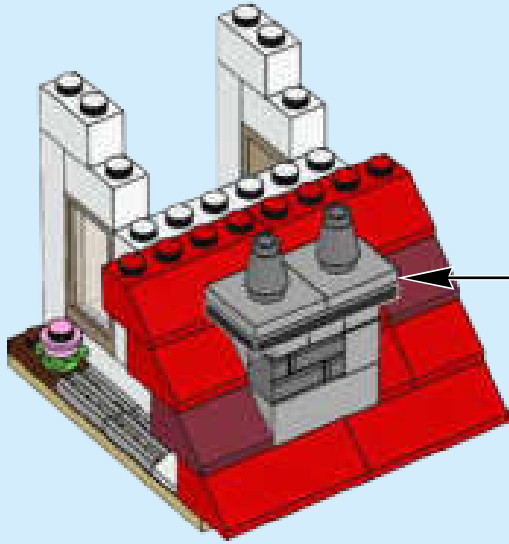
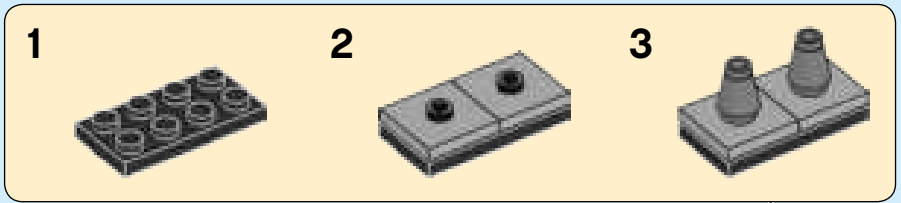

202

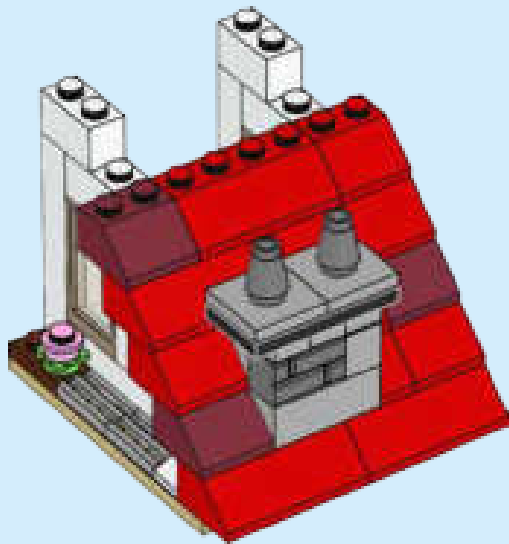

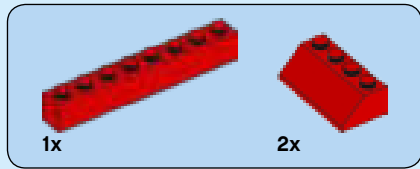

203

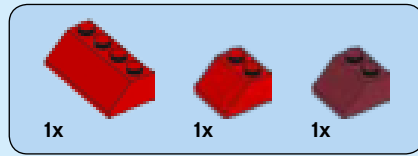
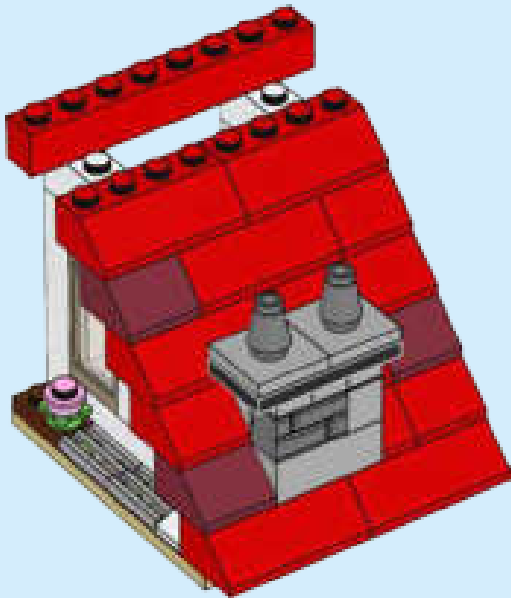

204

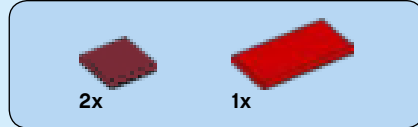
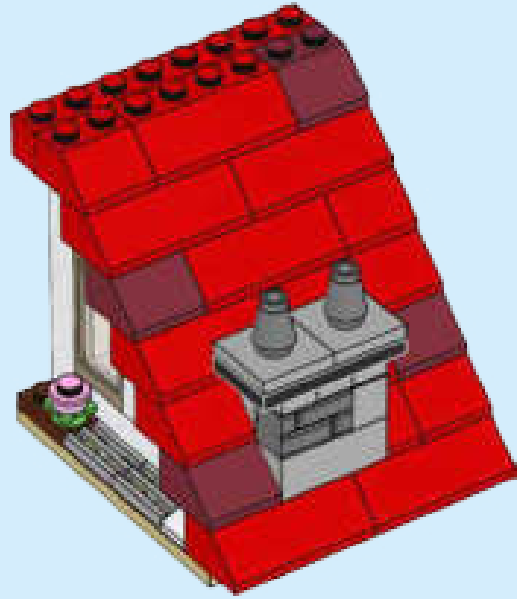

205

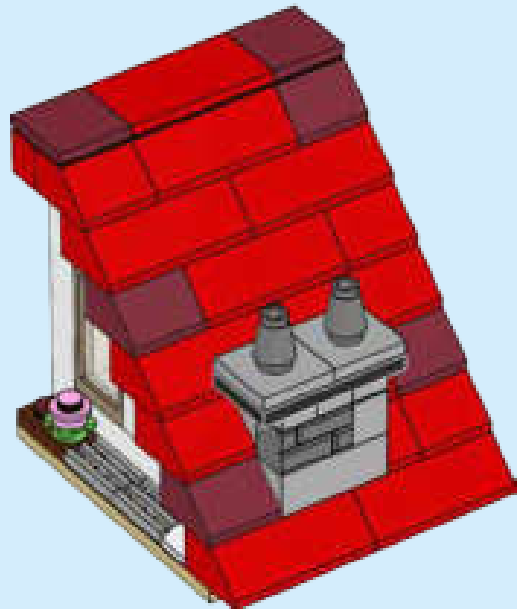



206



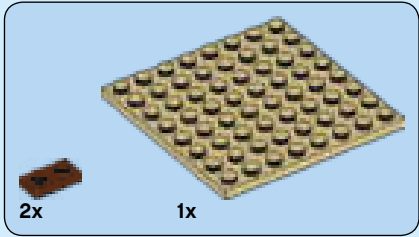

207

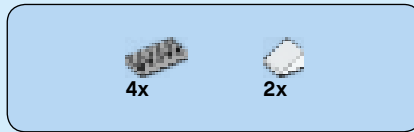

208

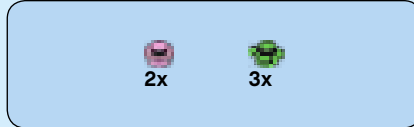
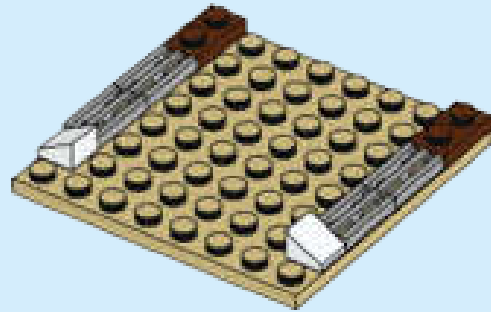

209

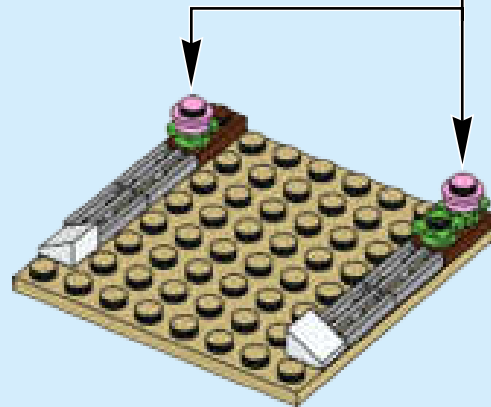

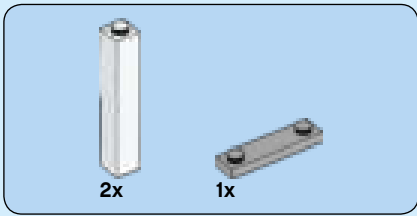

210

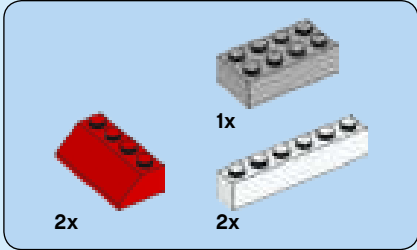
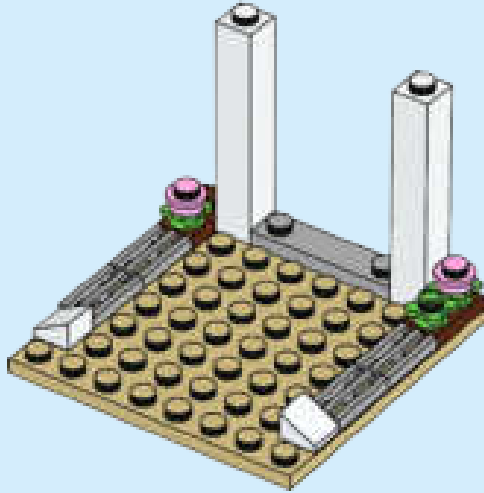

211

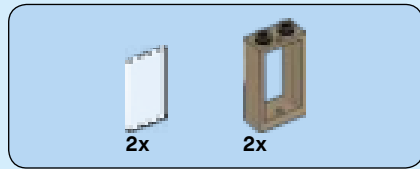
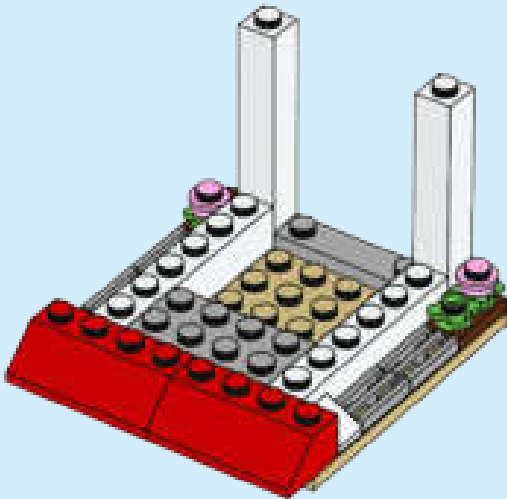

212

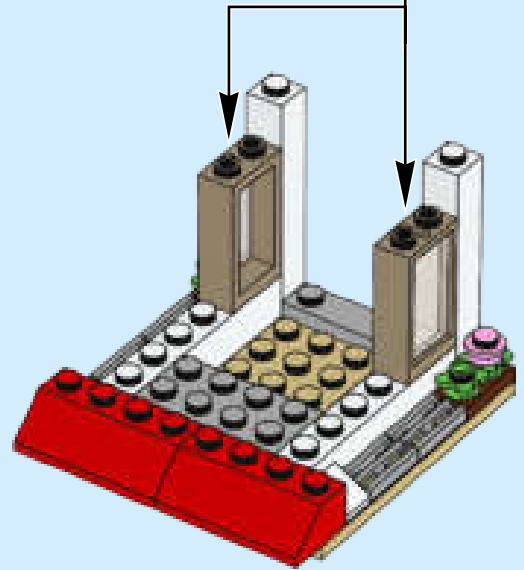
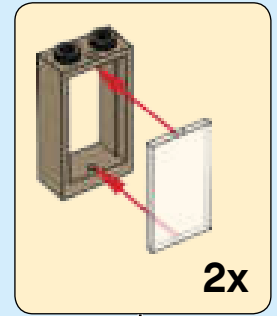

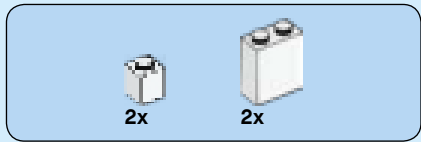

# 213

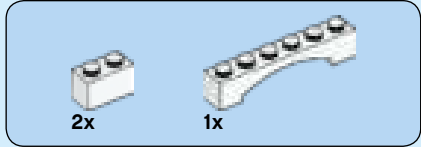
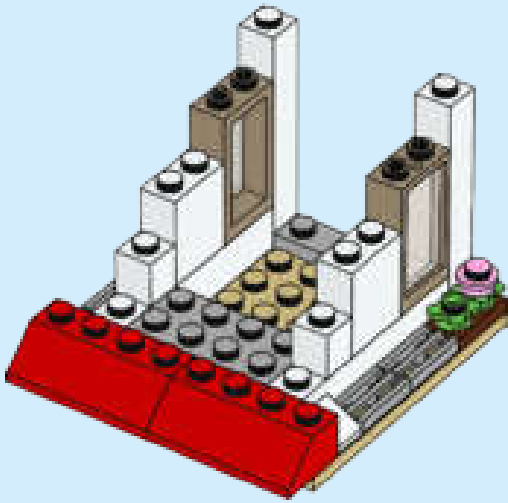

# 214

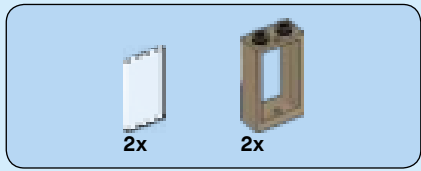
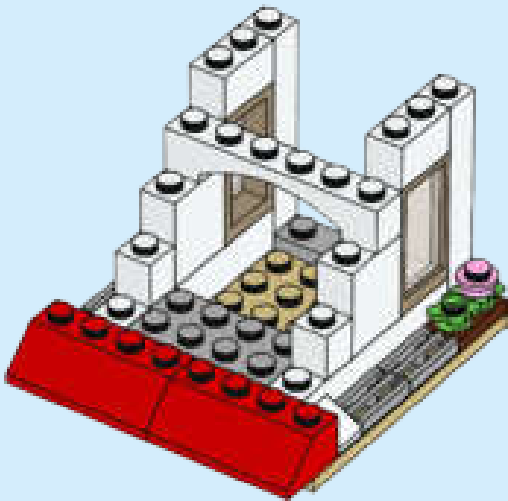

# 215

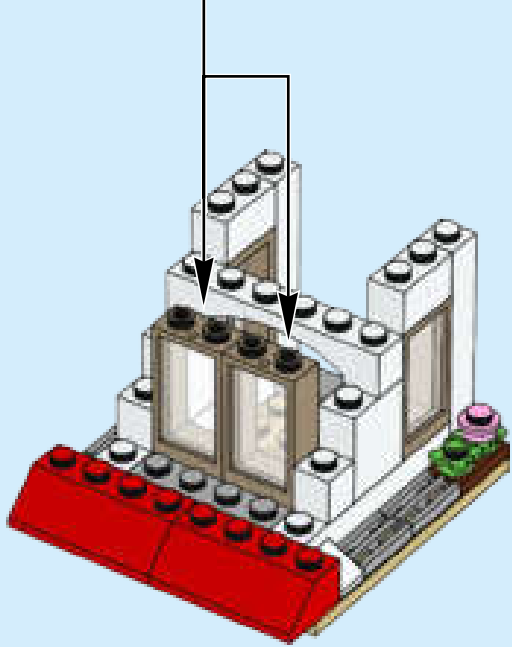
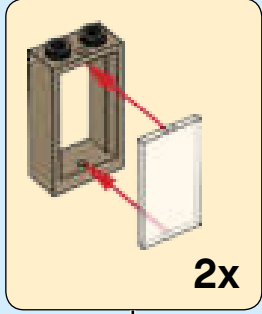

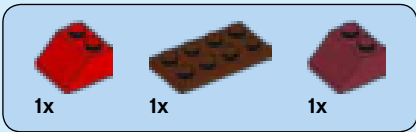

216

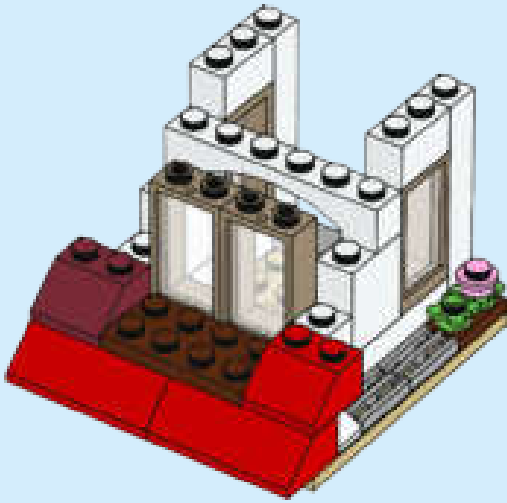

217

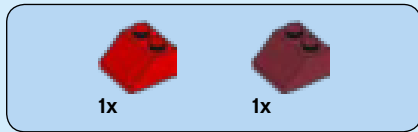
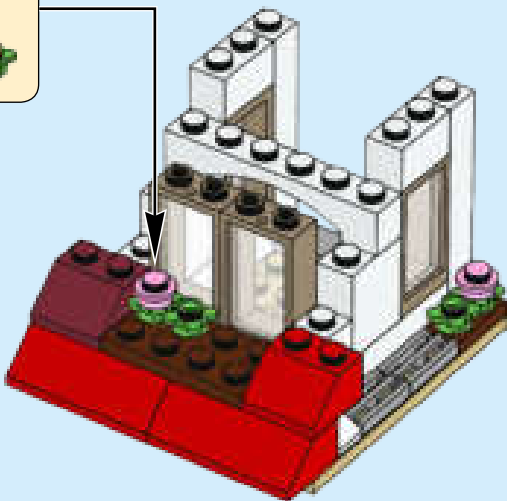

218

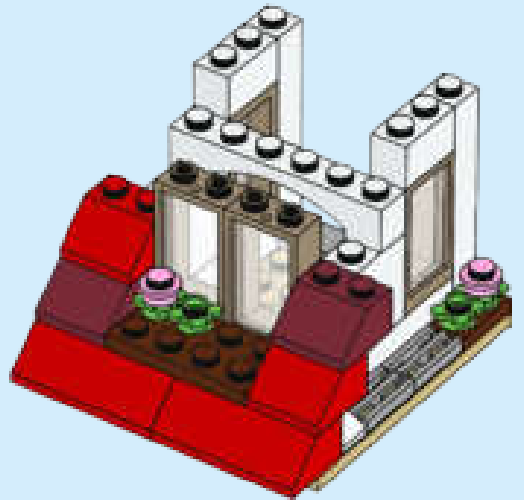

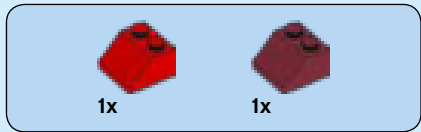

# 219

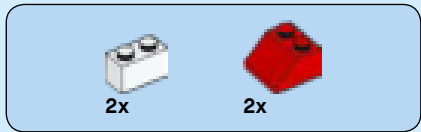
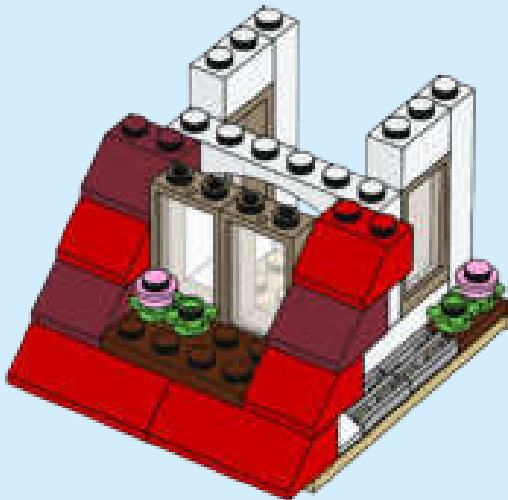

# 220

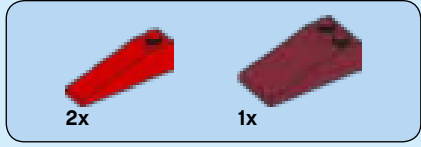
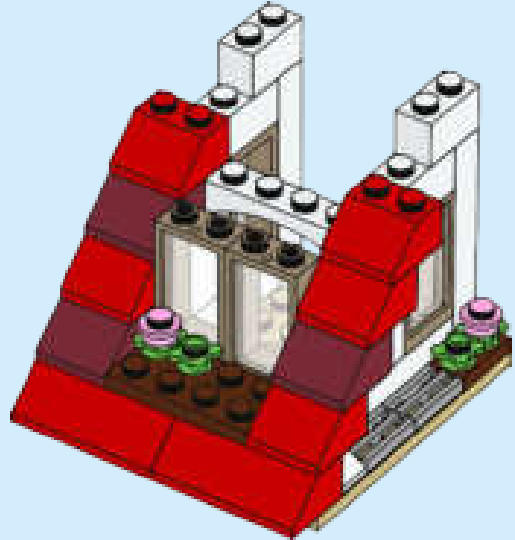

# 221

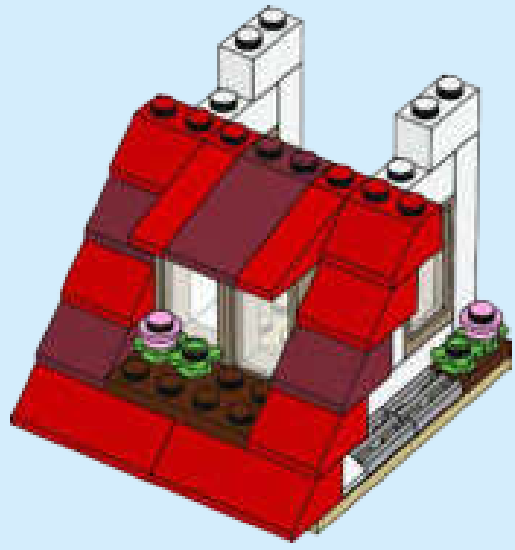

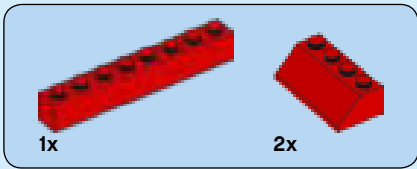

222

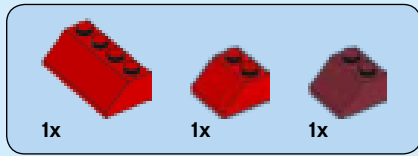
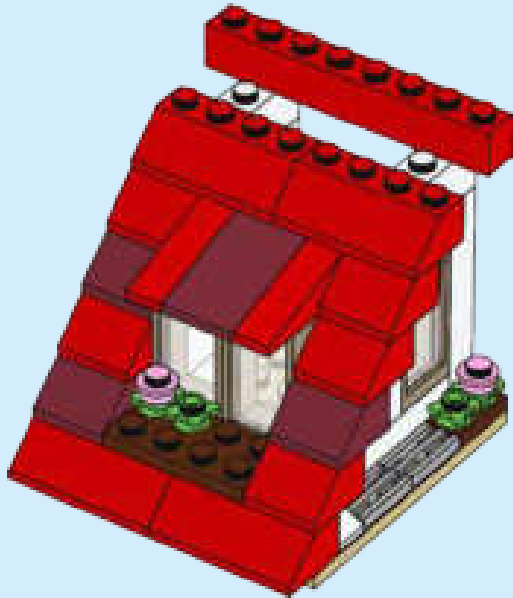

223

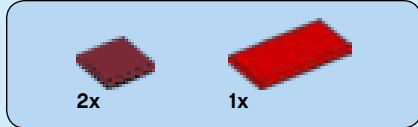
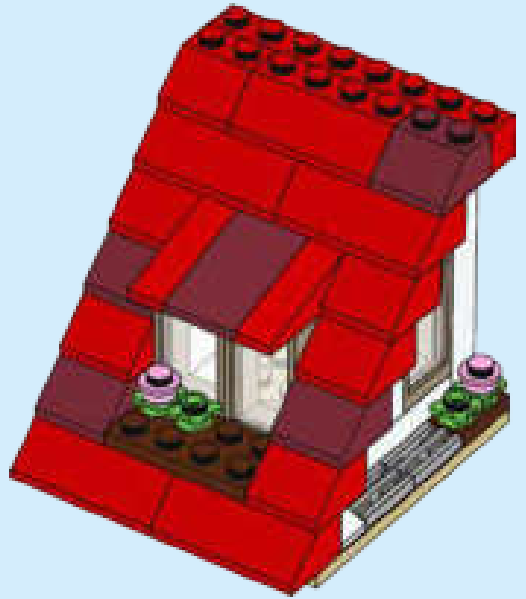

224



225









**CREATOR**

**3 in 1**



**31069**

**=**

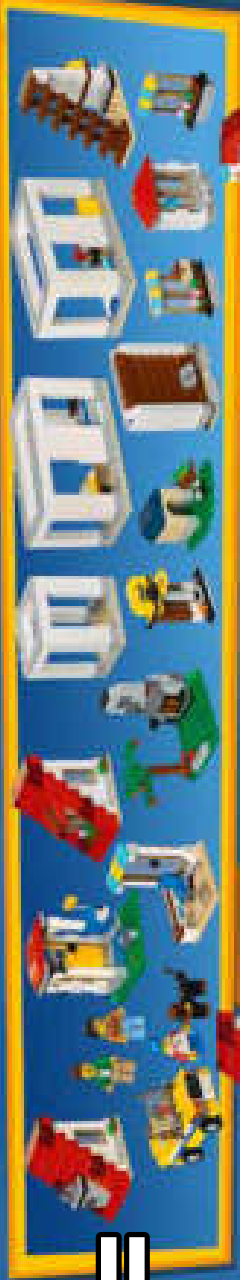

3 in 1  
3 en 1  
3 em 1  
3 az egyben  
3 合 1

MODULAR  
MODULAIRE  
MODULÁRE  
MODULÁRIS  
模块化



+



+



+



+



+





1

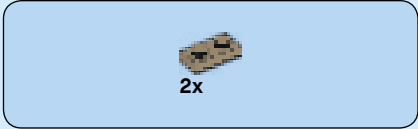
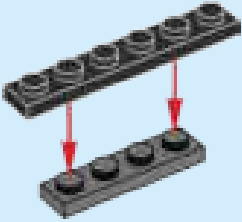

2



3

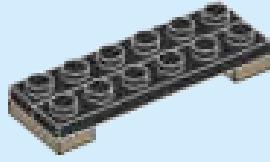

4

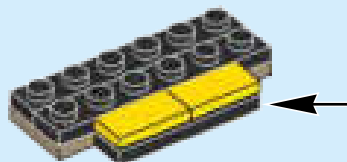
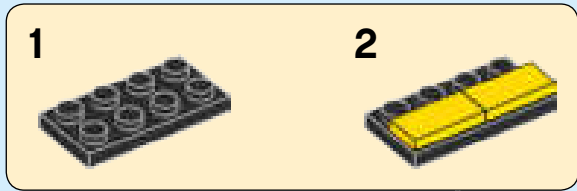

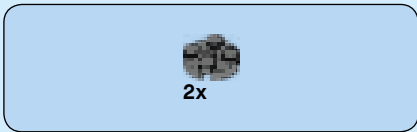

5

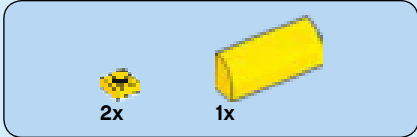
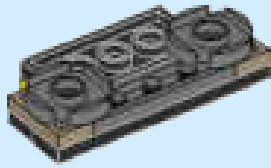

6

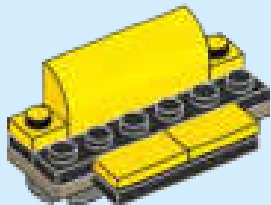
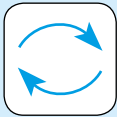

7

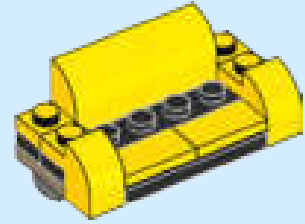

8

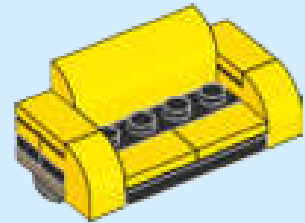

9

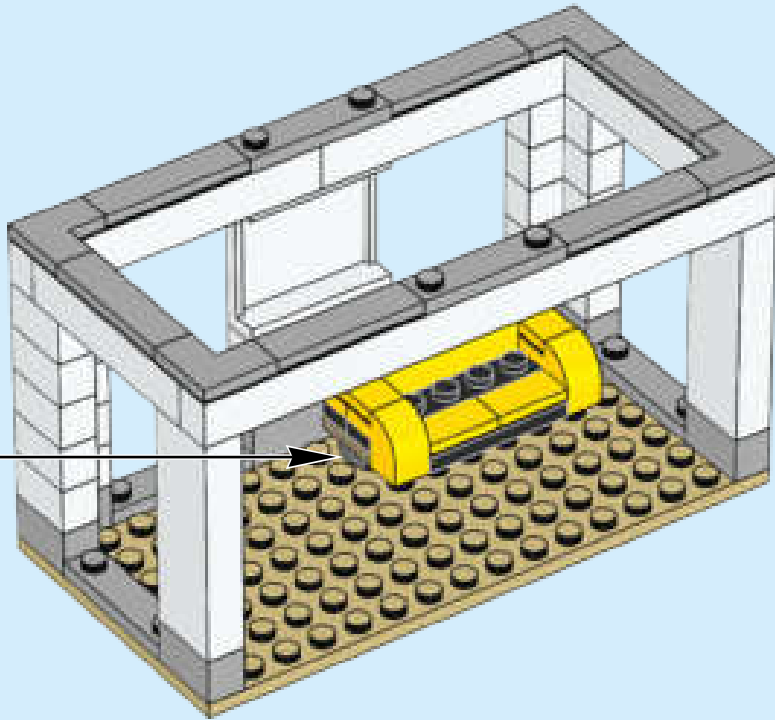

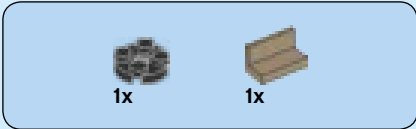

10



11

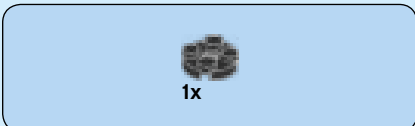

12

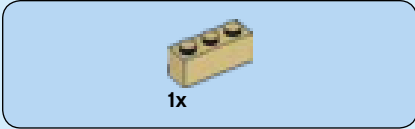
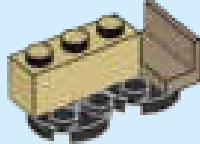

13



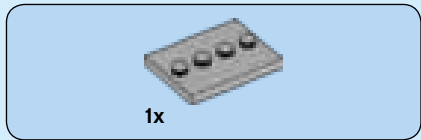

14

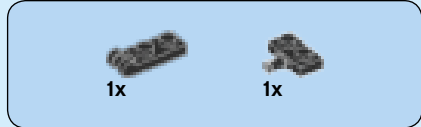
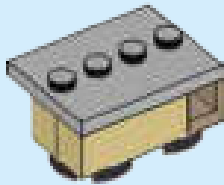

15

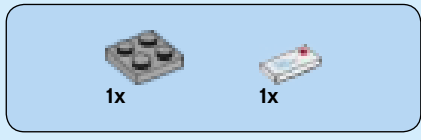
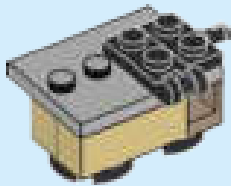

16



17





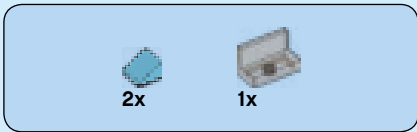

18

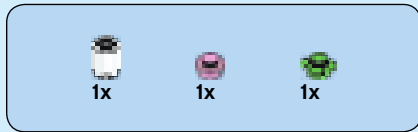
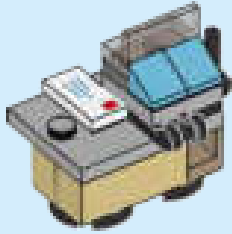

19

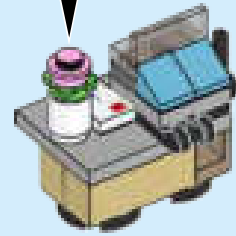

20

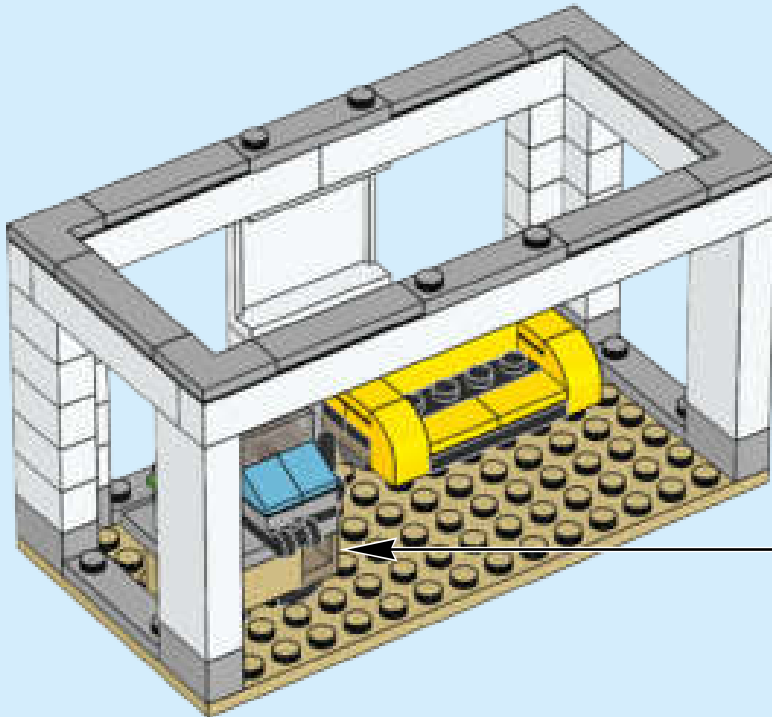

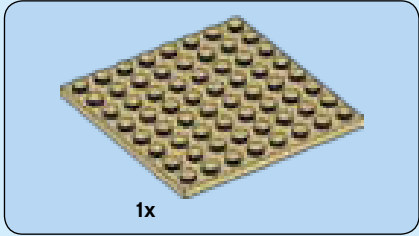

21

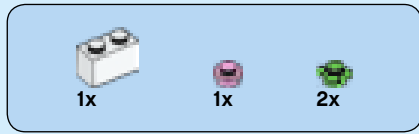
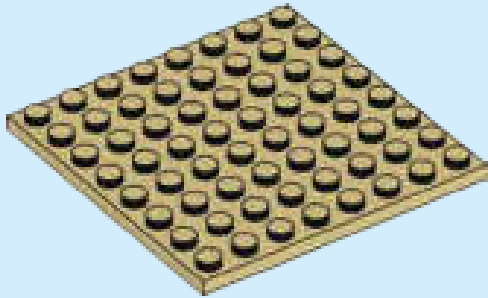

22

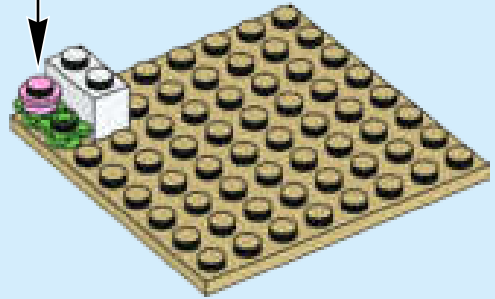
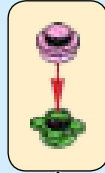

23

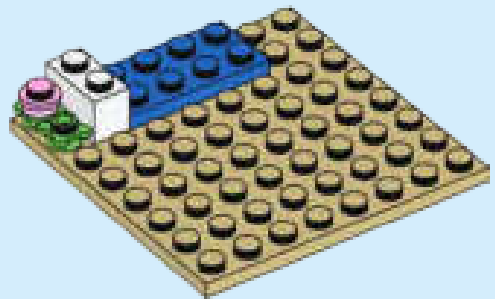

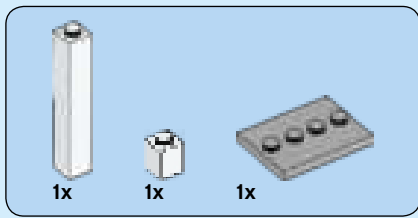

24

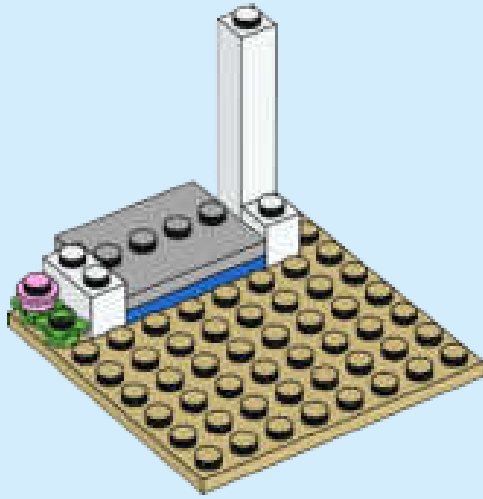

25

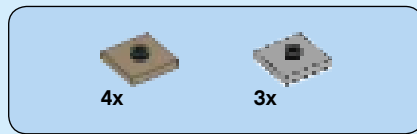
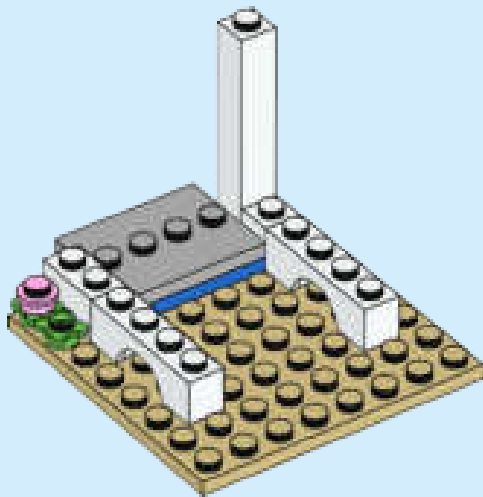

26

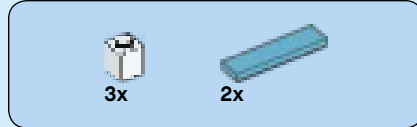
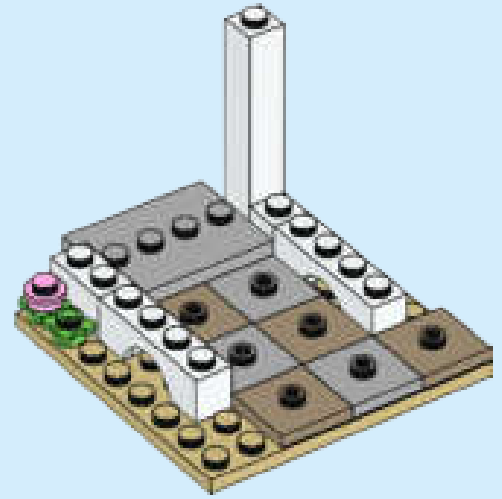

27

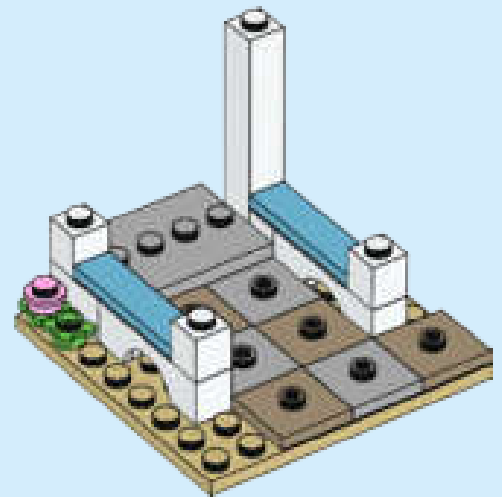

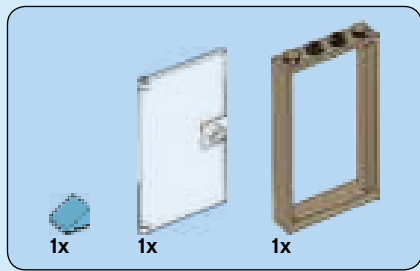

28

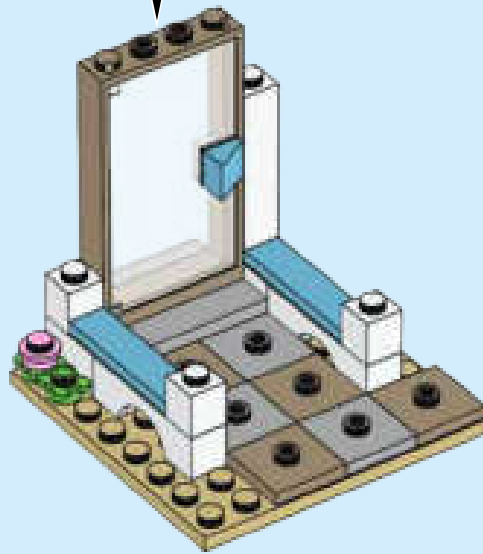
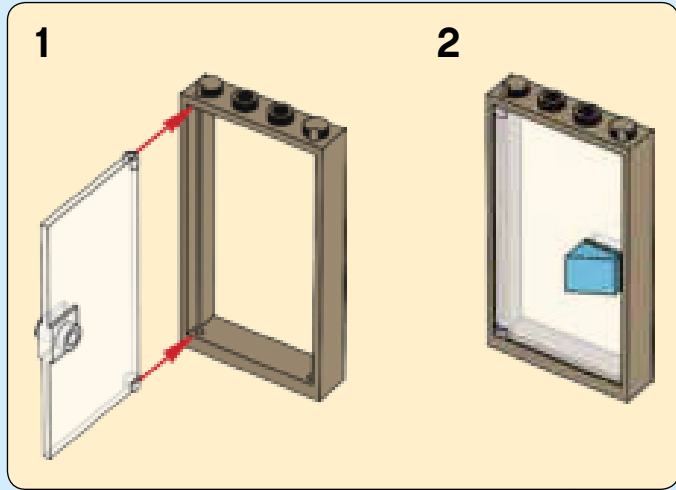

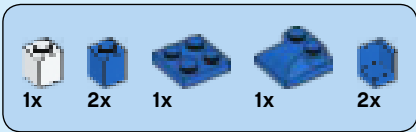

# 29

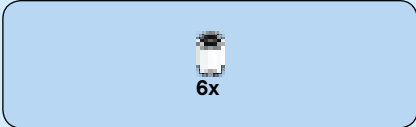
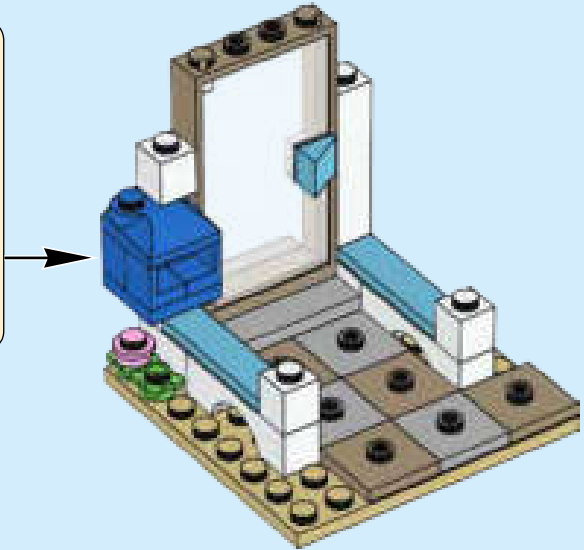
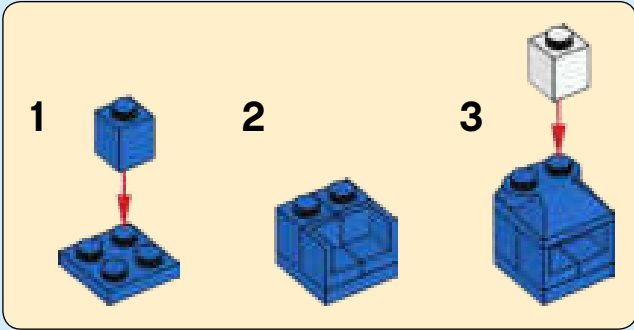

# 30

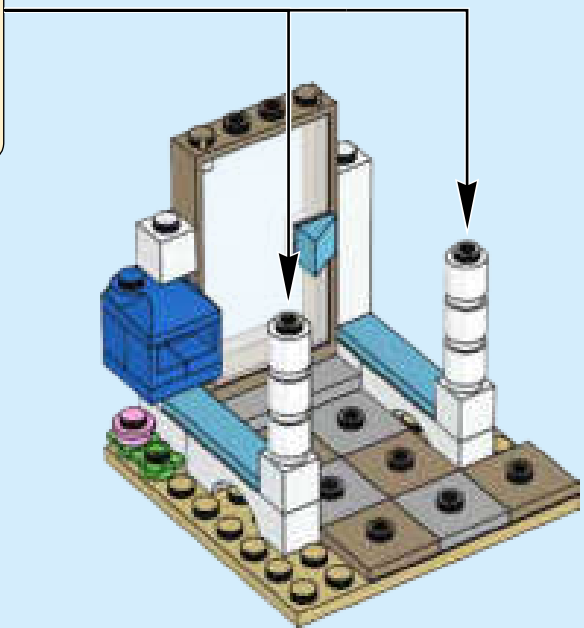
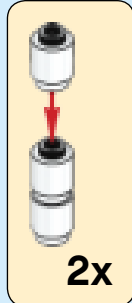

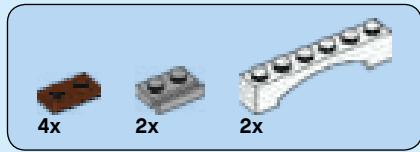

31

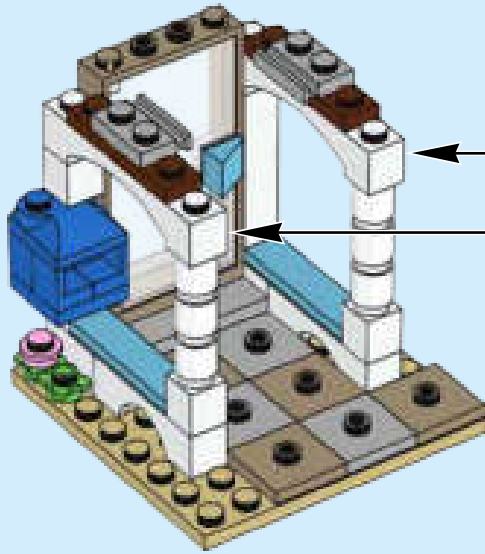
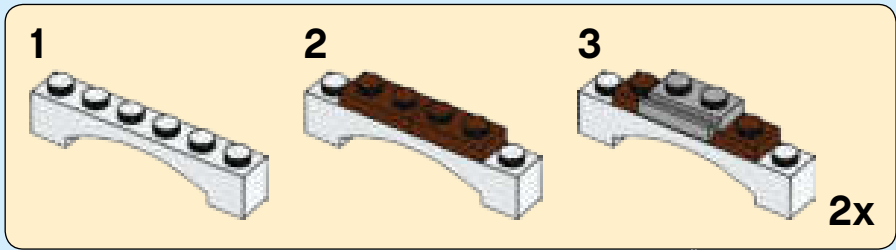

32

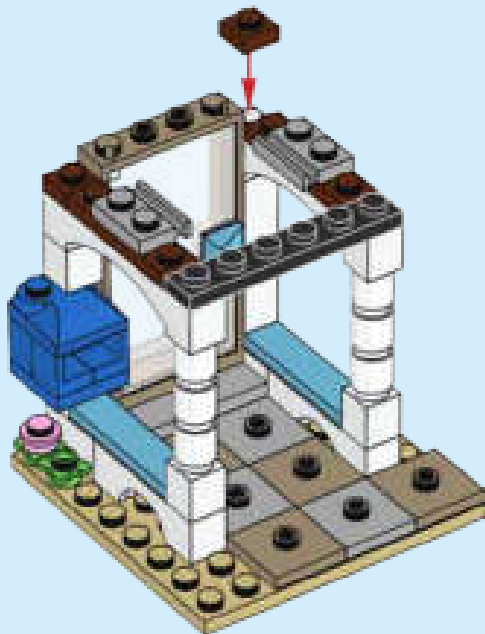

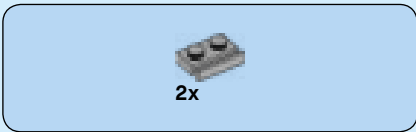

# 33

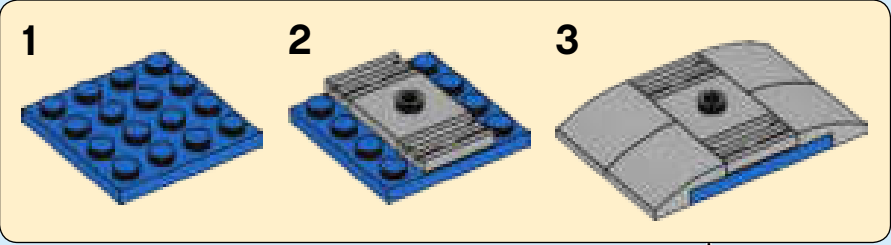
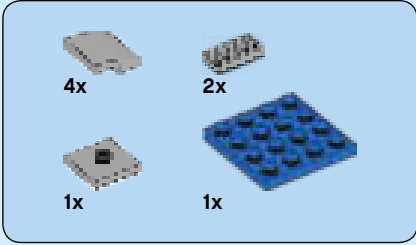
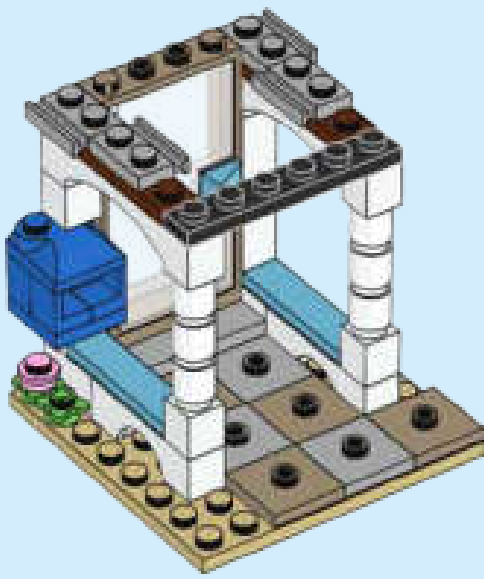

# 34

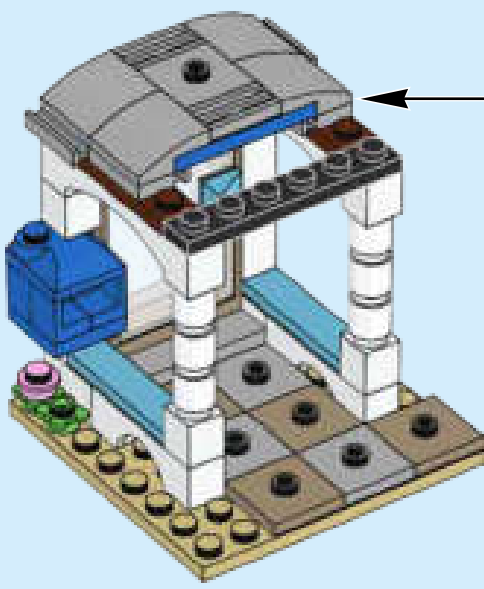

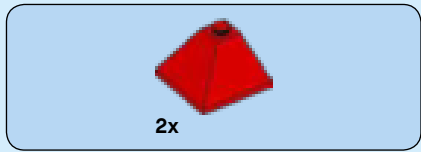

35

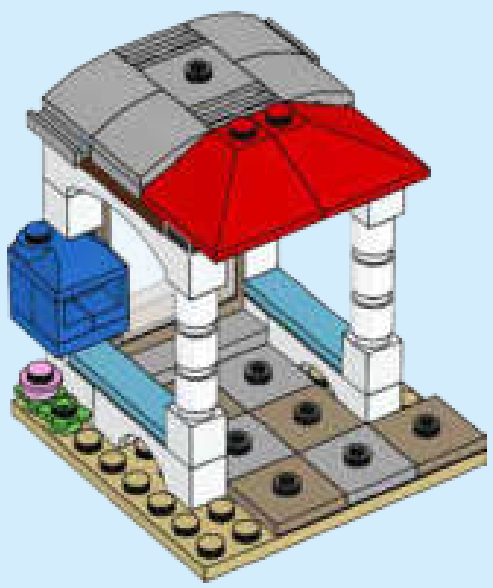

36

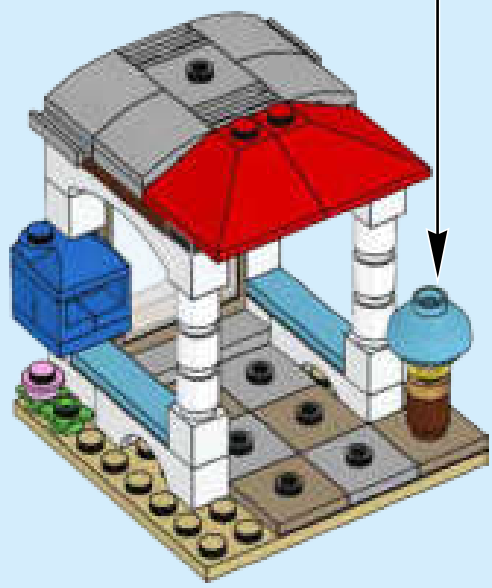



37

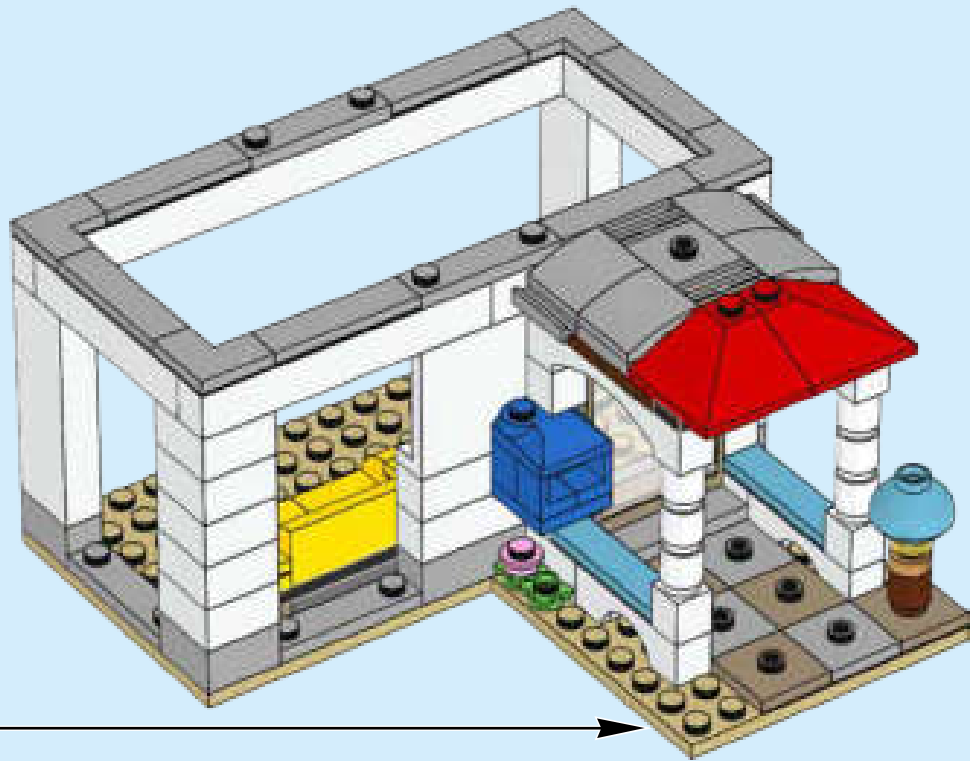
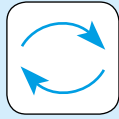

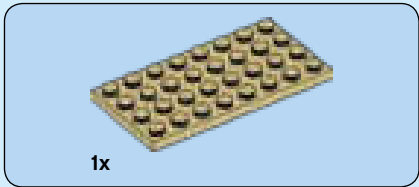

1x

38

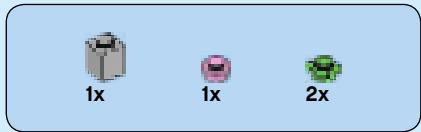
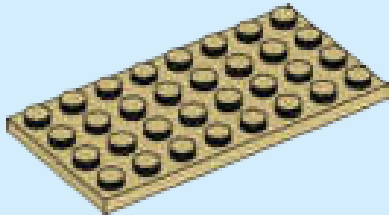

39

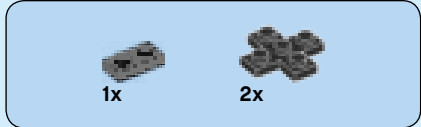
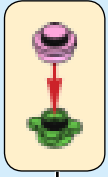

40

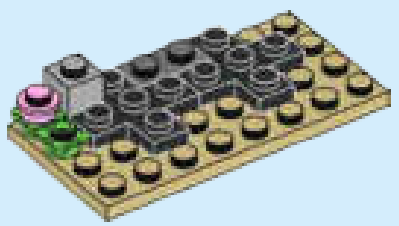



41

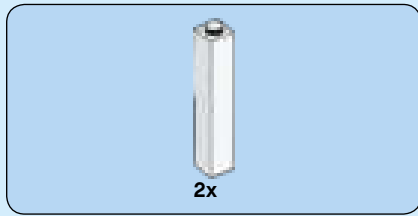

43

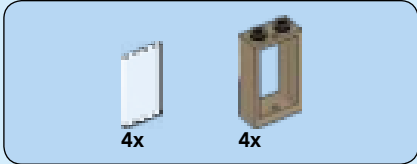

42

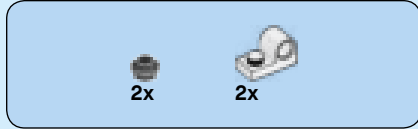
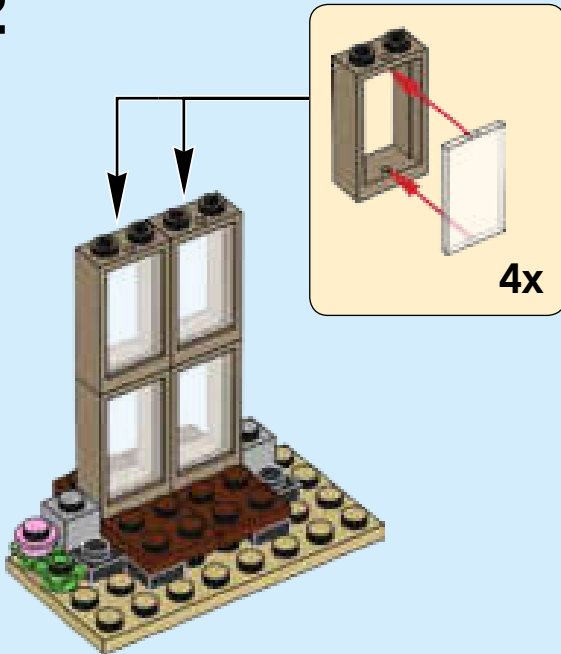

44

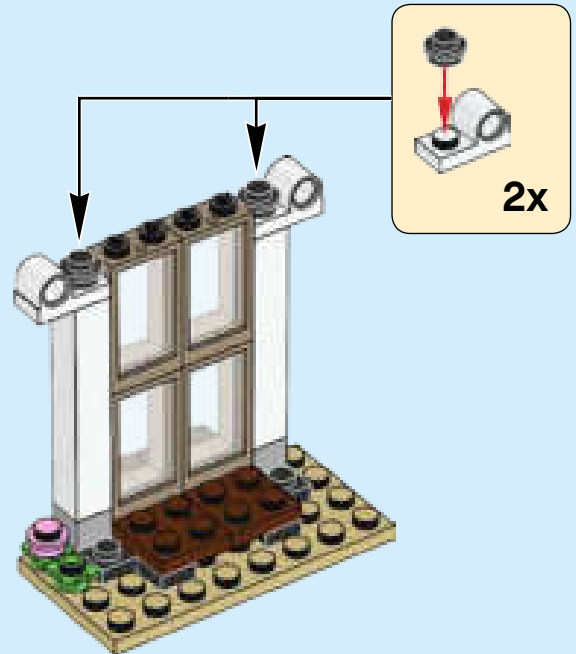

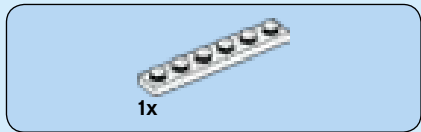

45

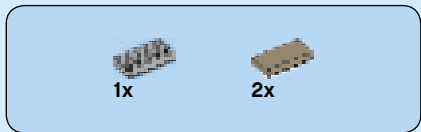

46



47

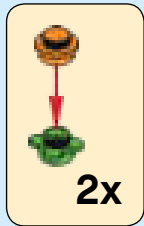

48

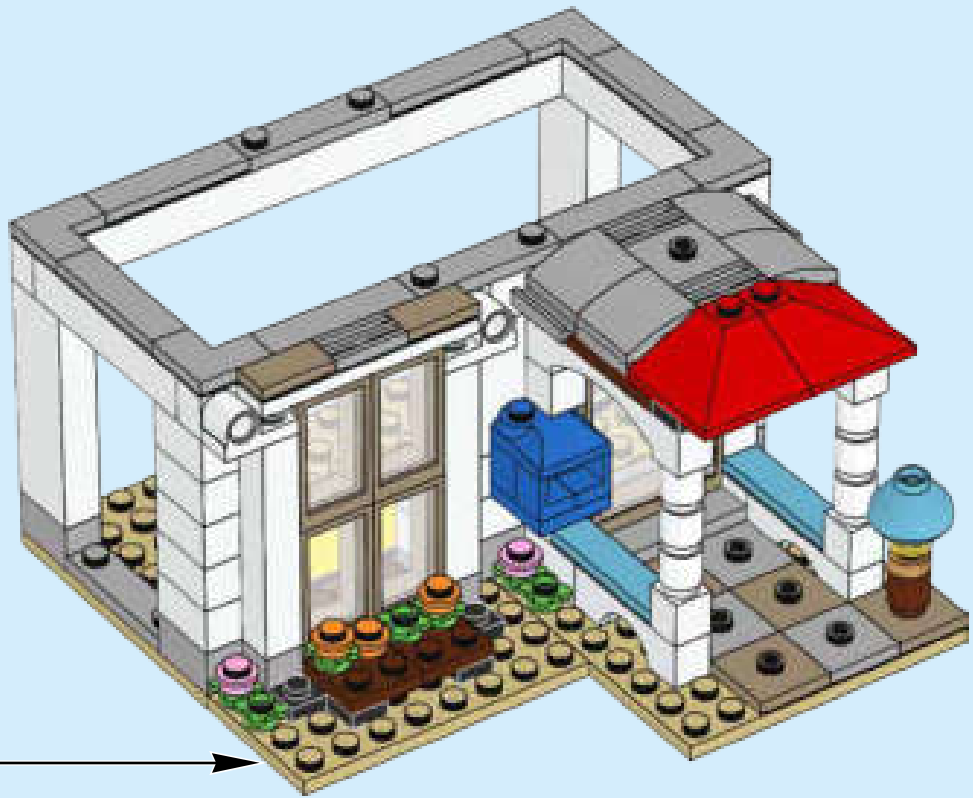

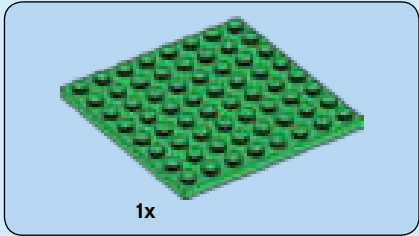
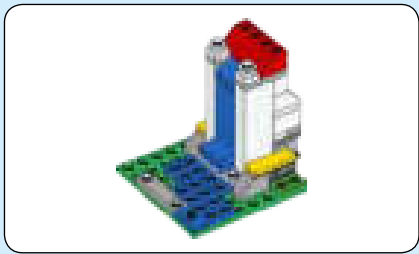

1x

49

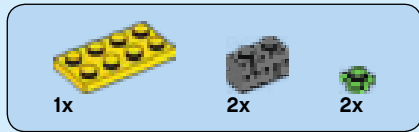
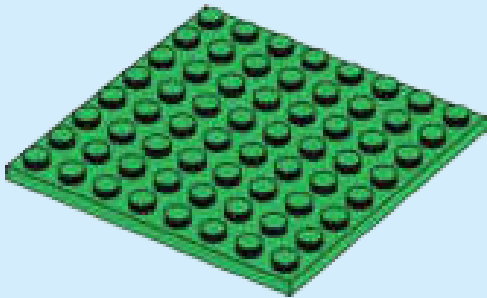

1x

2x

2x

50

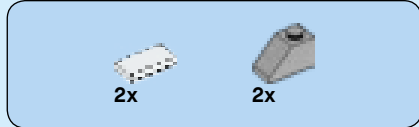
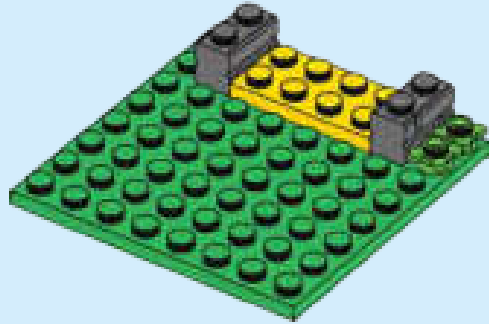

2x

2x

51

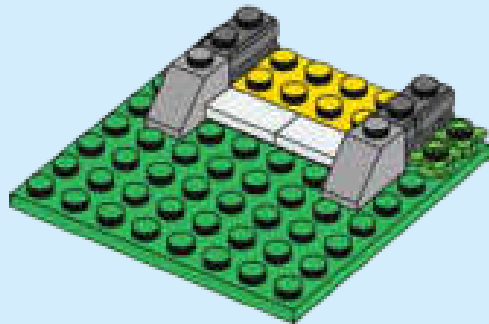



52

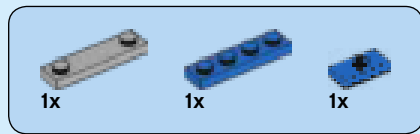
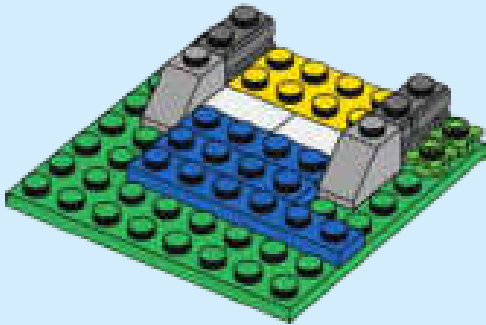

53

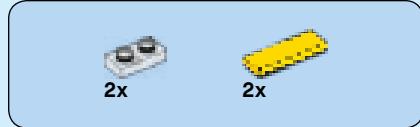
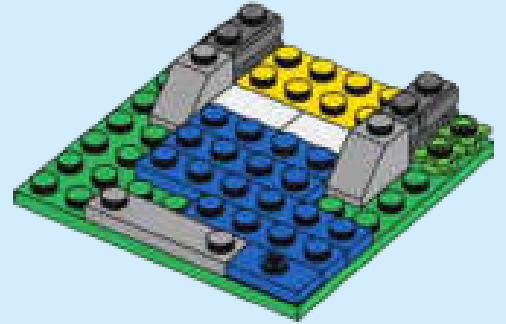

54

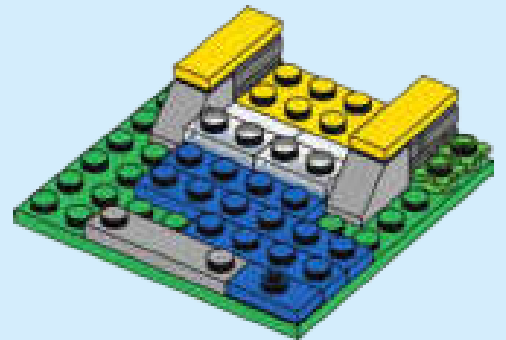



55

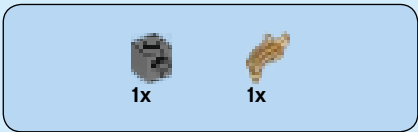
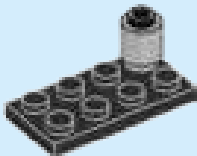

56

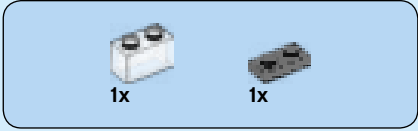
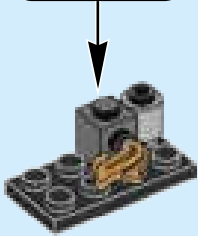
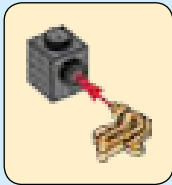

57





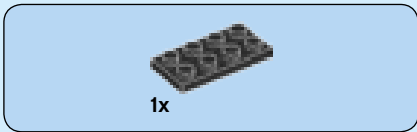

58

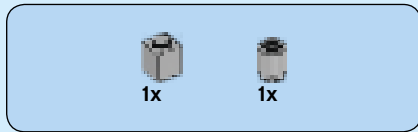
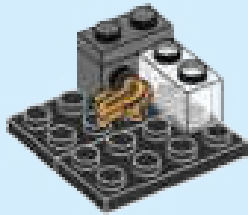

59

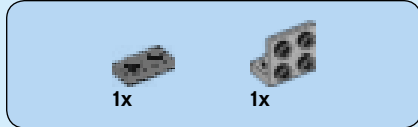
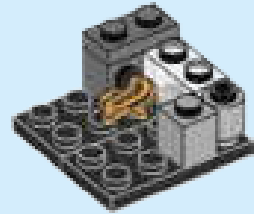

60

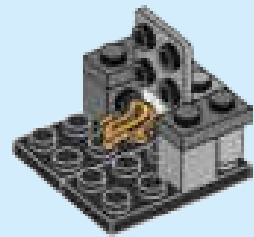

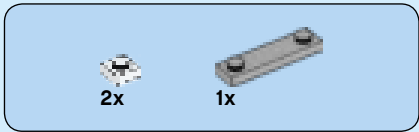

61

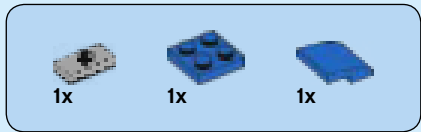
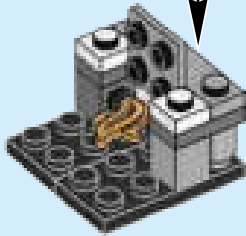
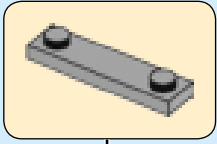

63

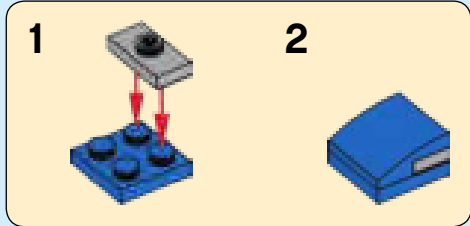

62

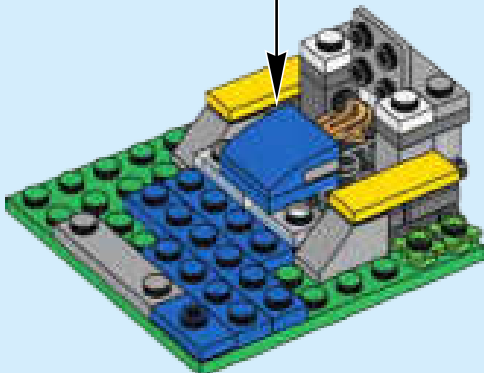
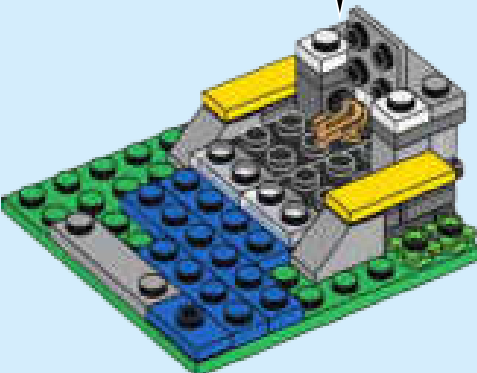

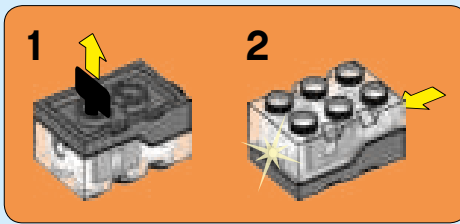
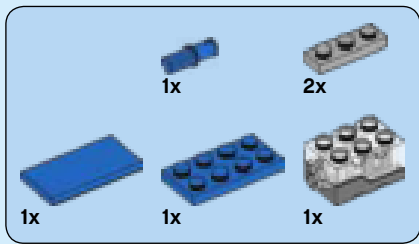

# 64

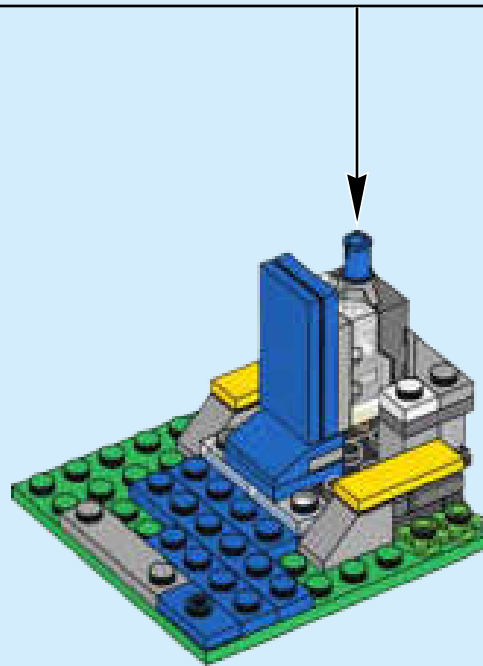
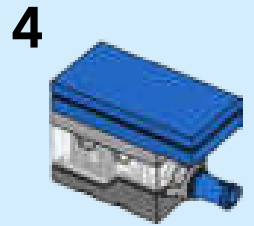
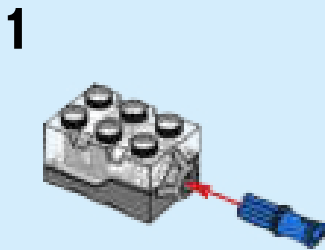



# 65

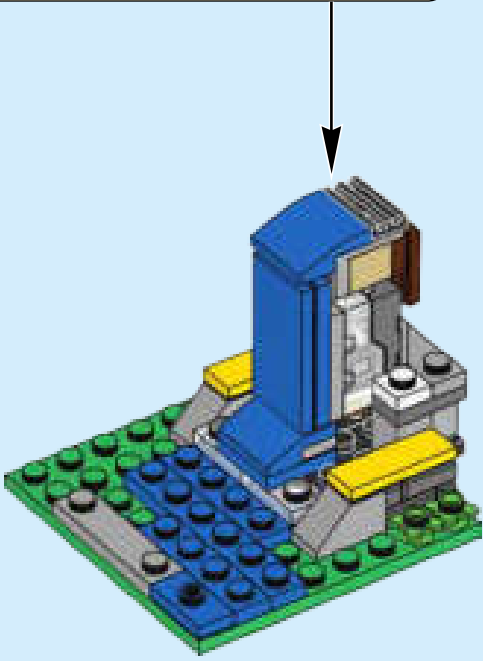
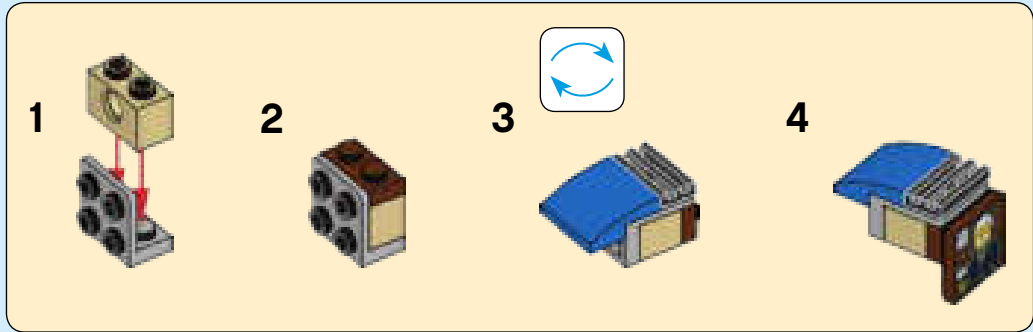

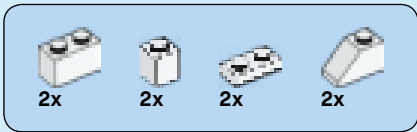

66

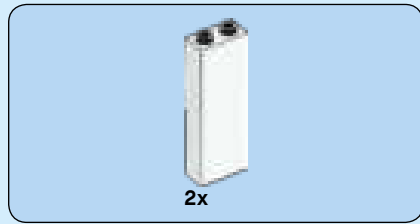
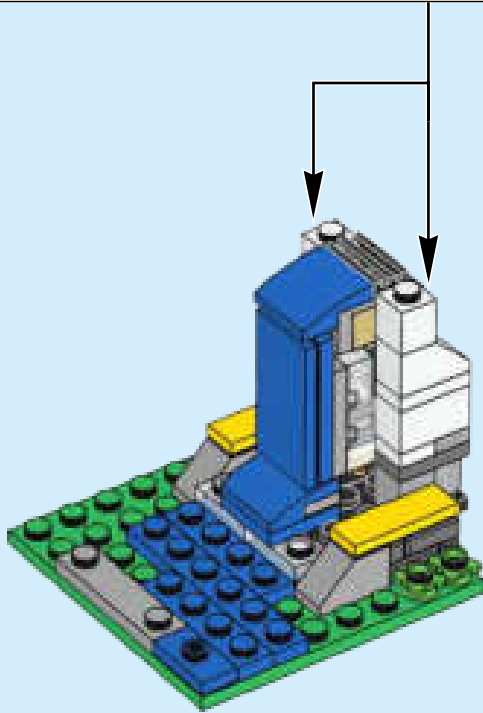
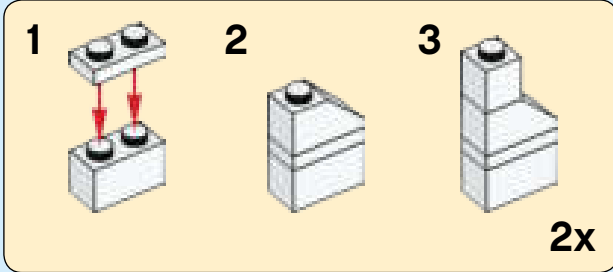

67

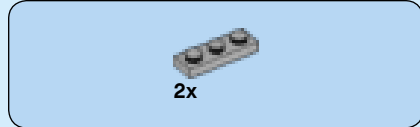
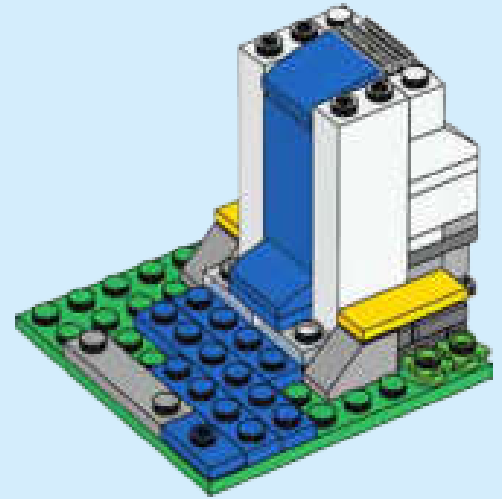

68

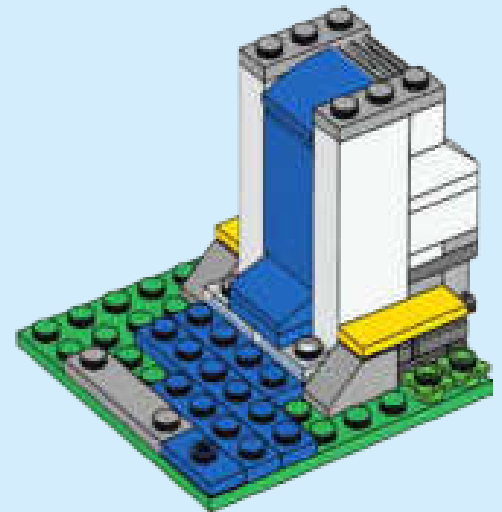

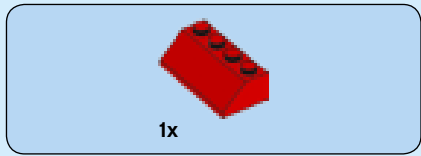

69

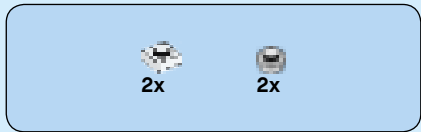
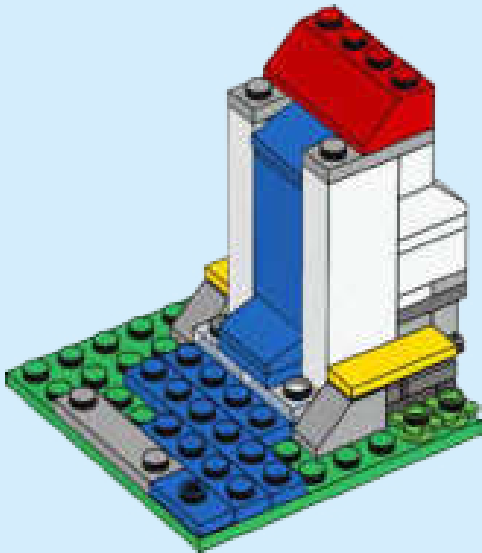

70

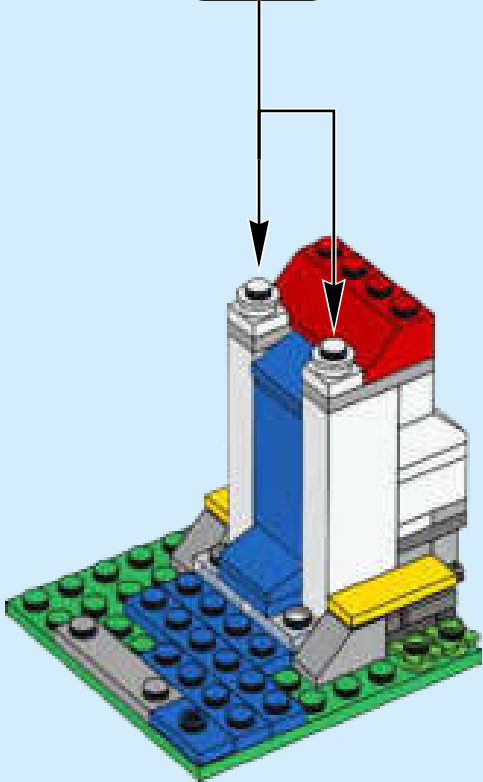
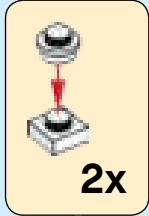

71

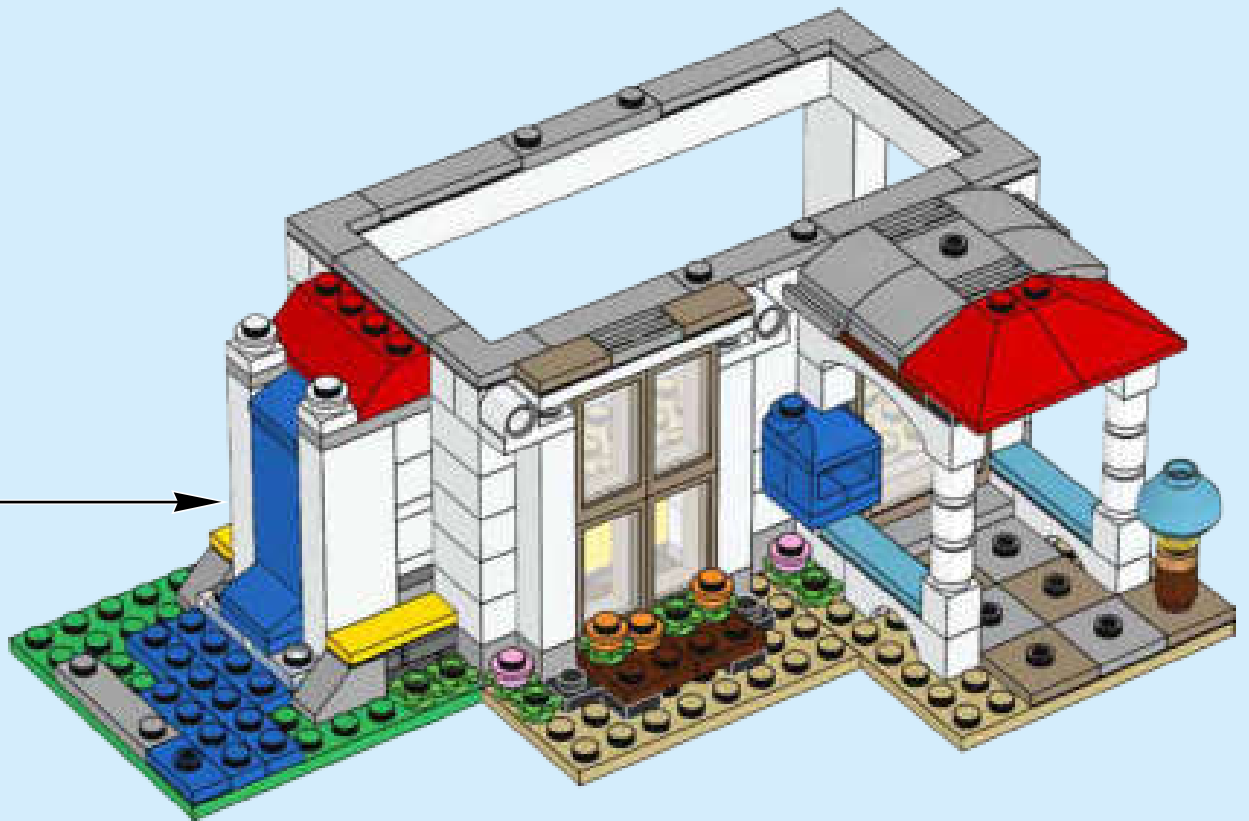

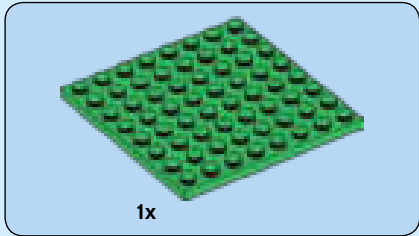
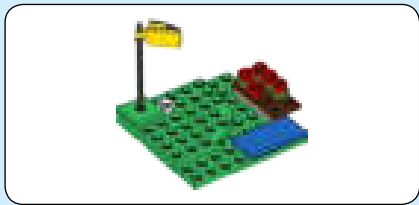

72

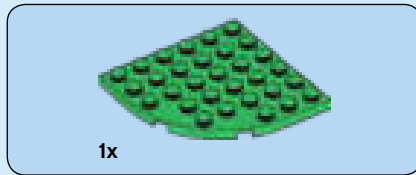
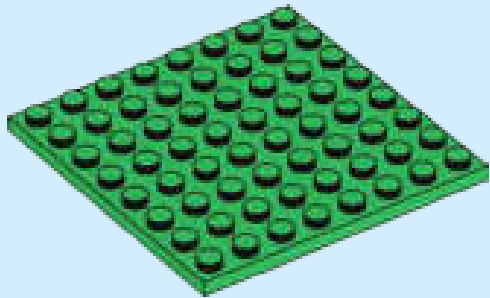

73

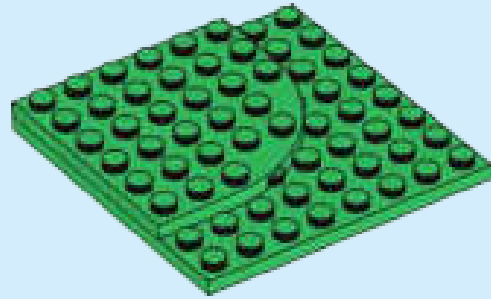

74

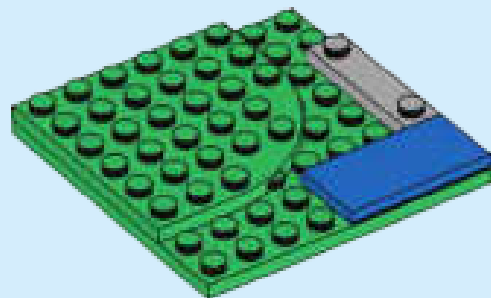



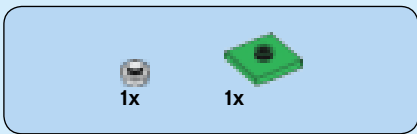

75

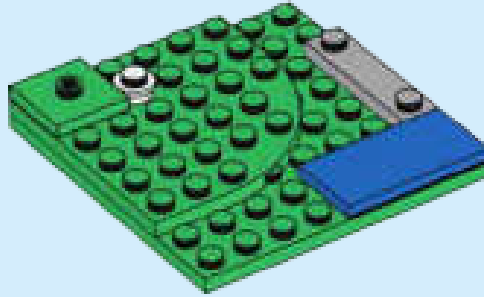

76

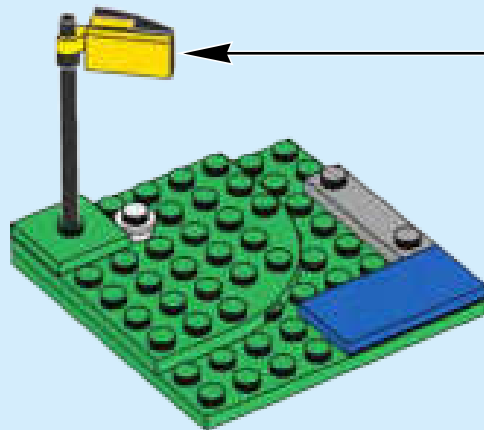

5x 4x 1x

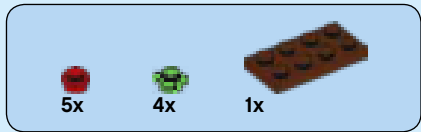

# 77

1 2 3

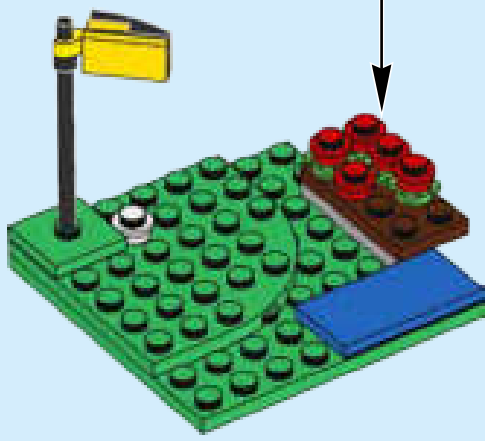

78

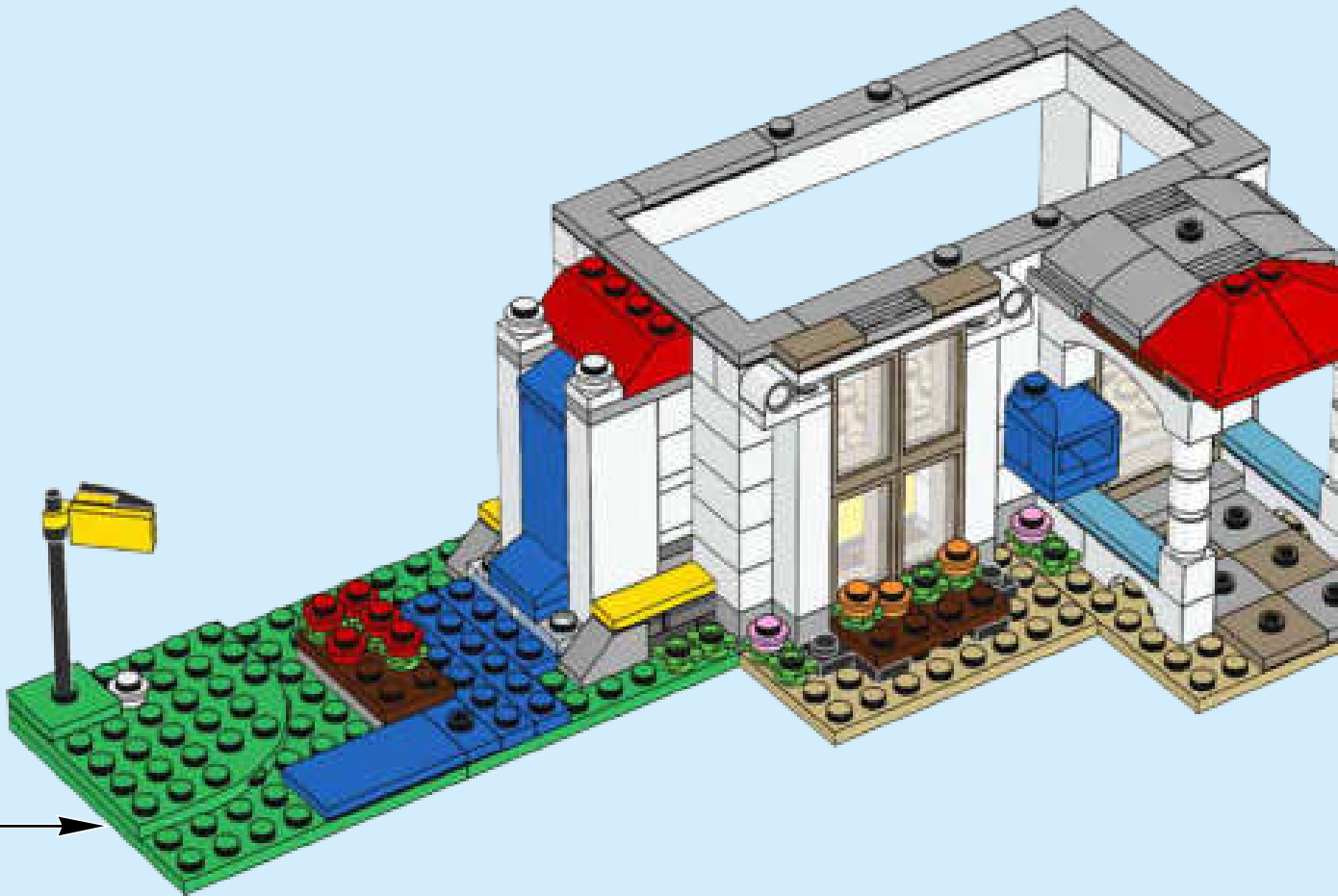

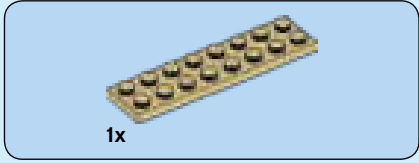

79

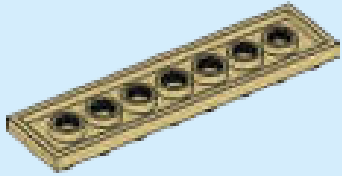

80

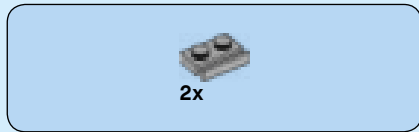
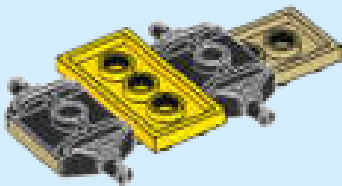

81

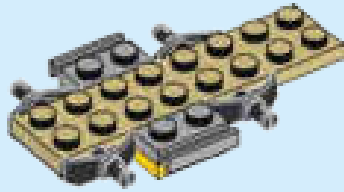
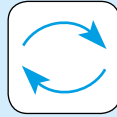

82

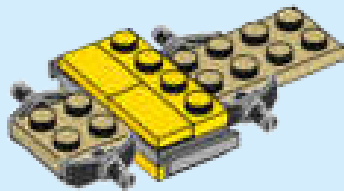

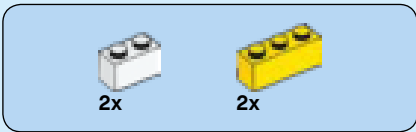

83

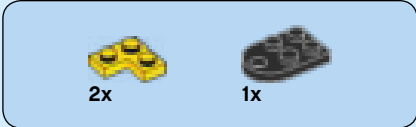
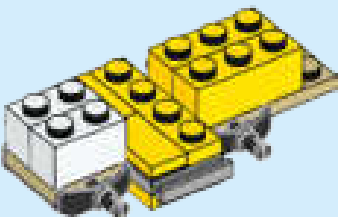

84

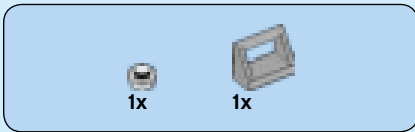
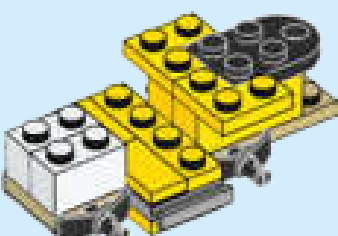

85

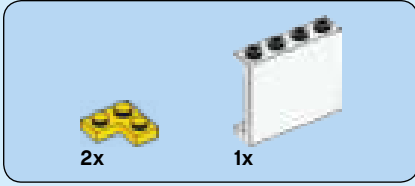
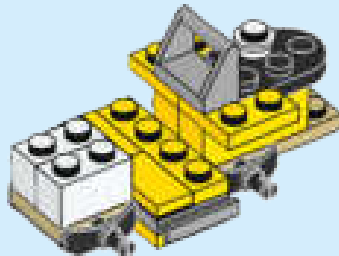

86

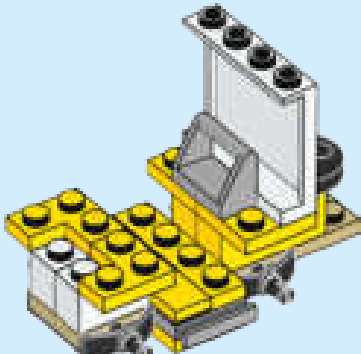



1x

# 87

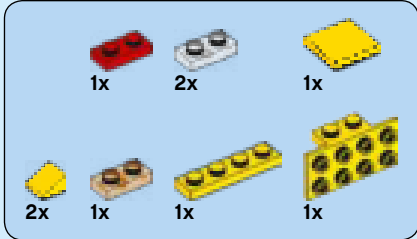
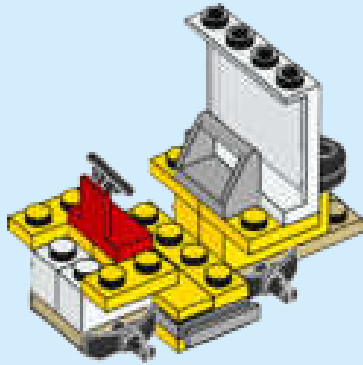

# 88

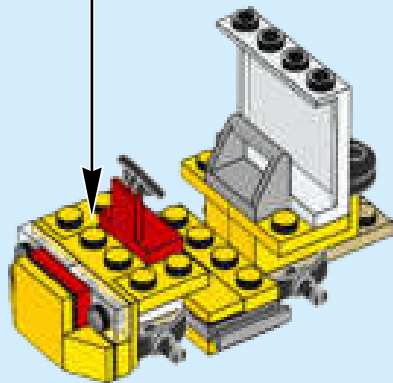
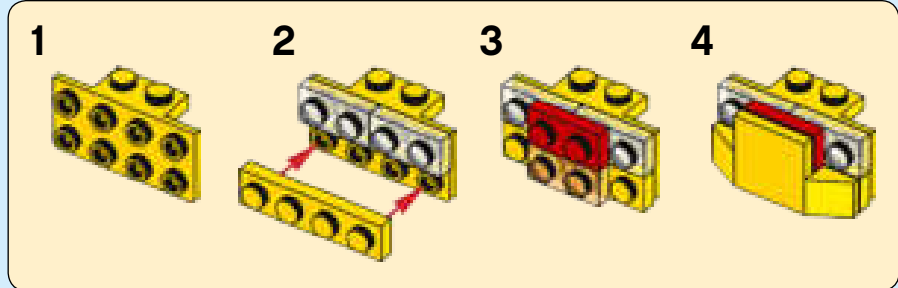

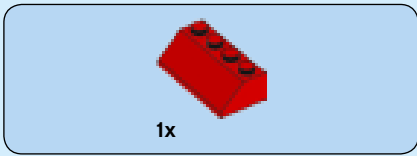

89

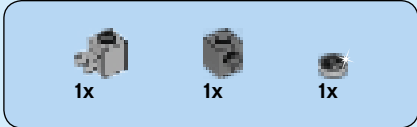
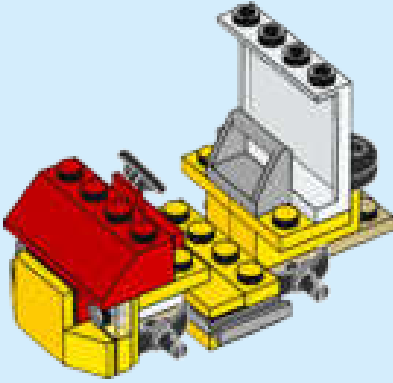

90

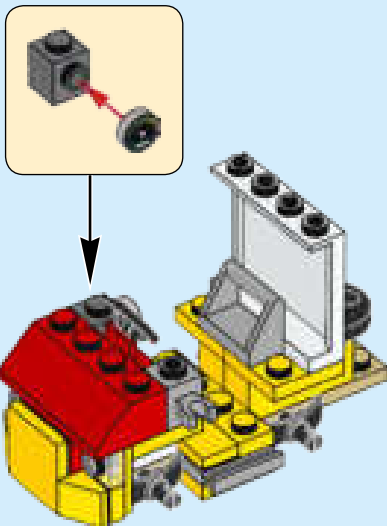

91

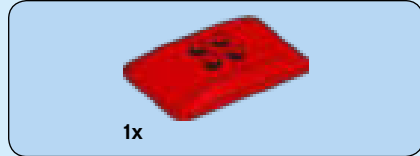
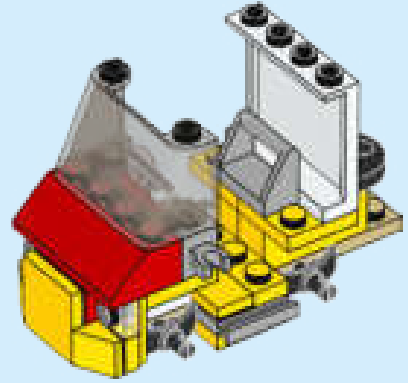

92

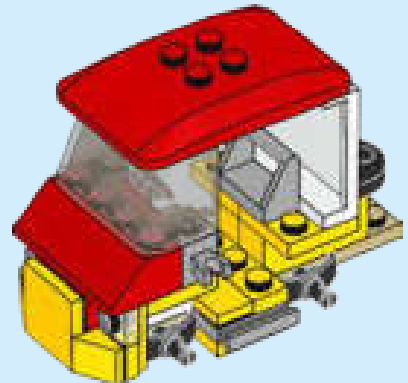



1x



1x

# 93

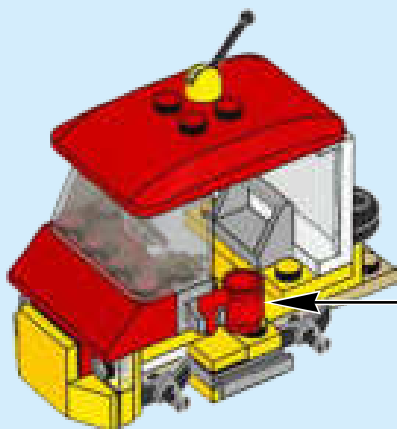

4x



4x

# 94

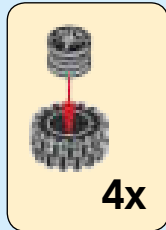

4x

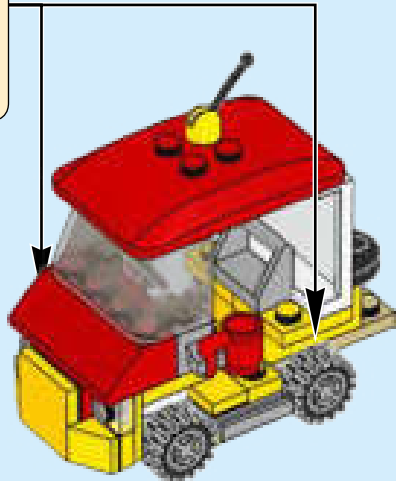

1x



1x

# 95

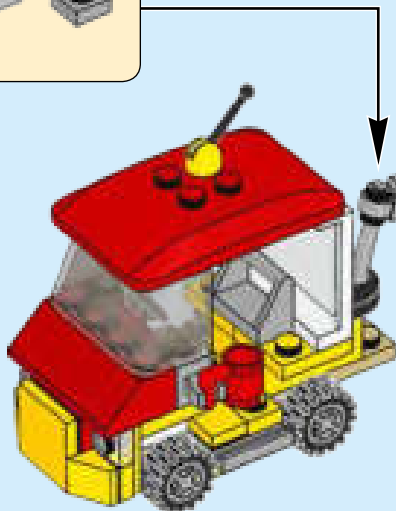
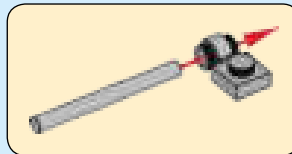



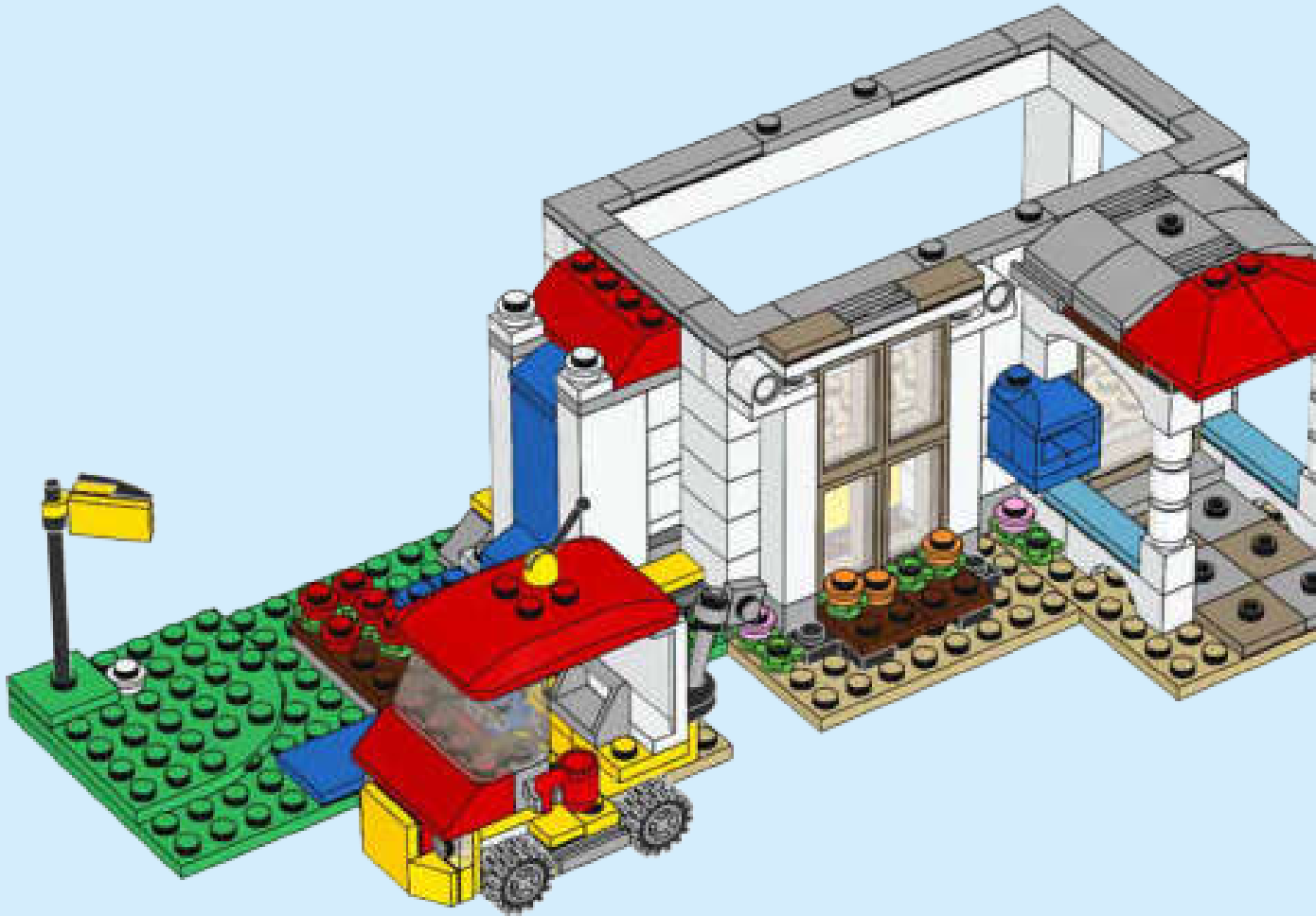

97

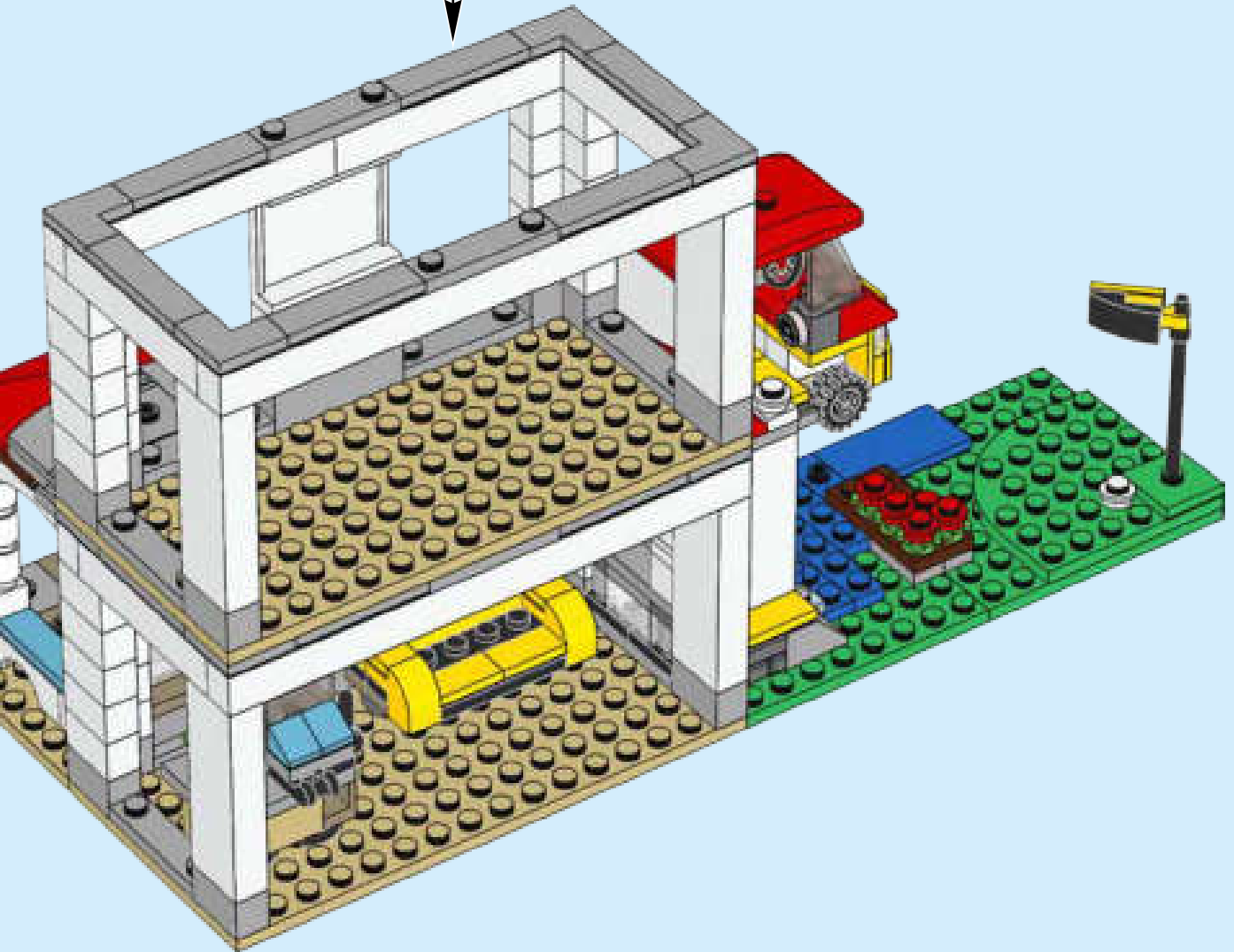
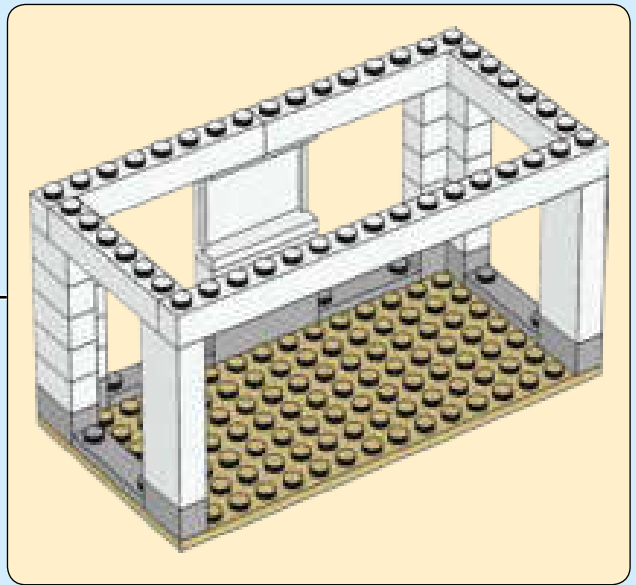

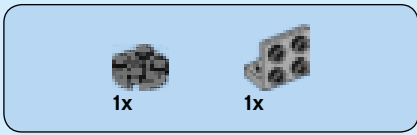

98

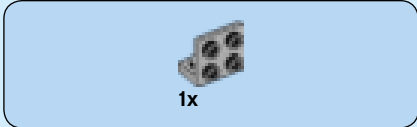
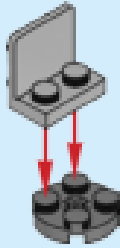

99

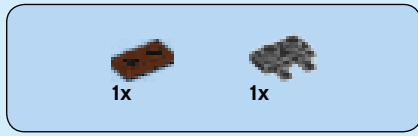
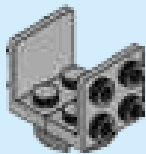

100



101

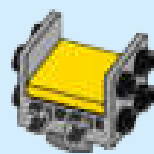

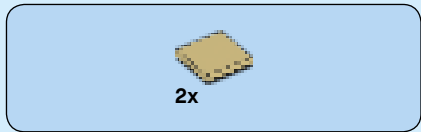

# 102

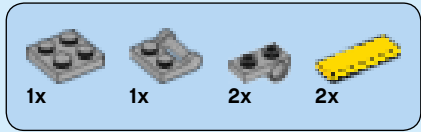
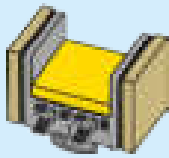

# 103

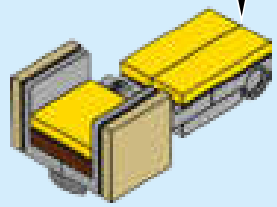
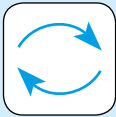
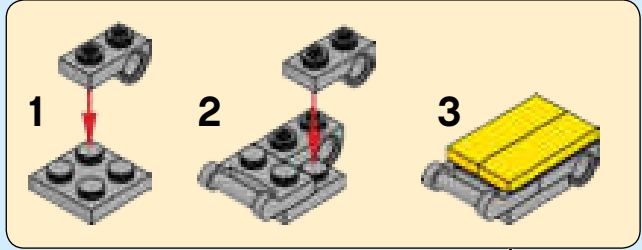

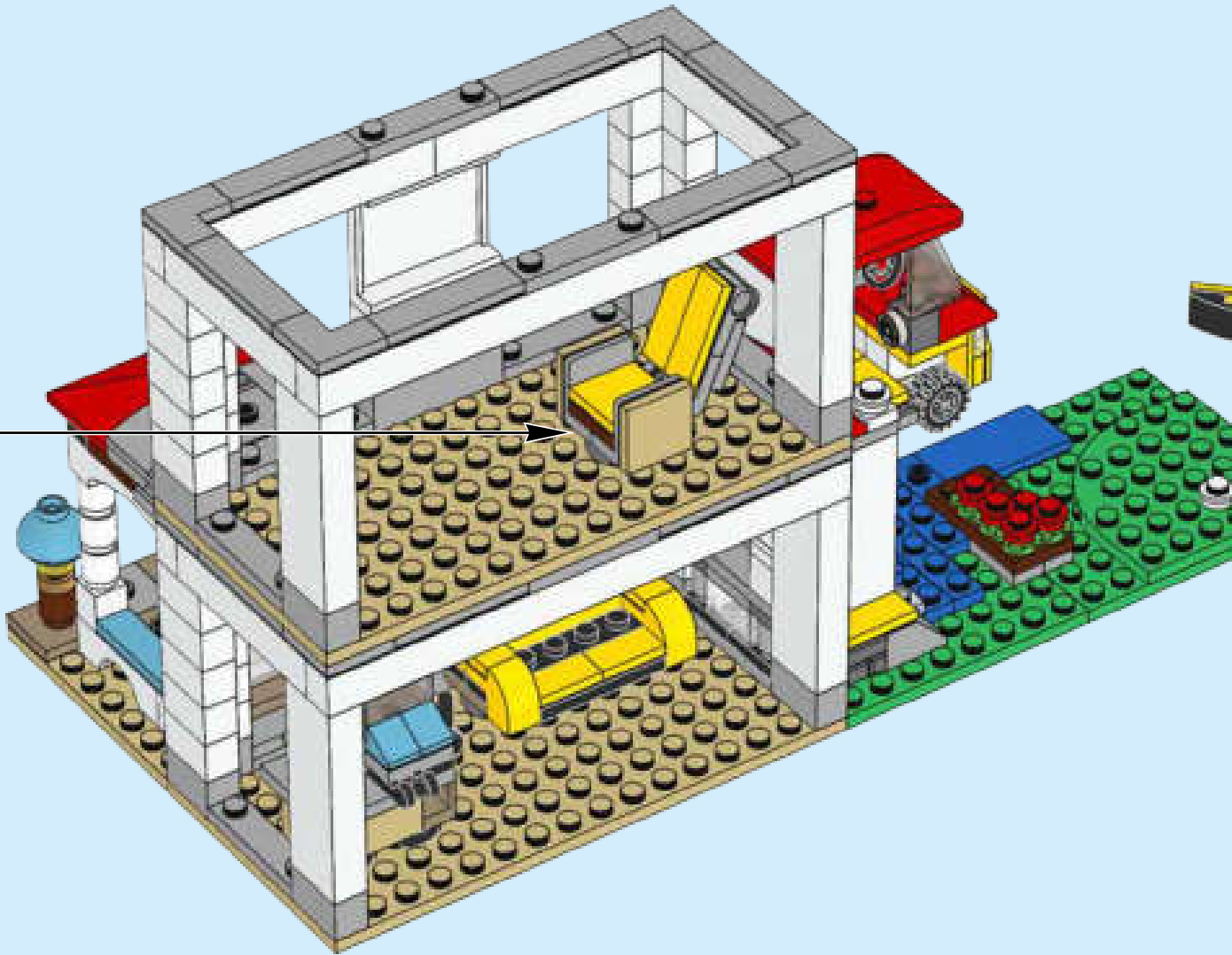

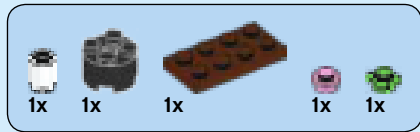

# 105

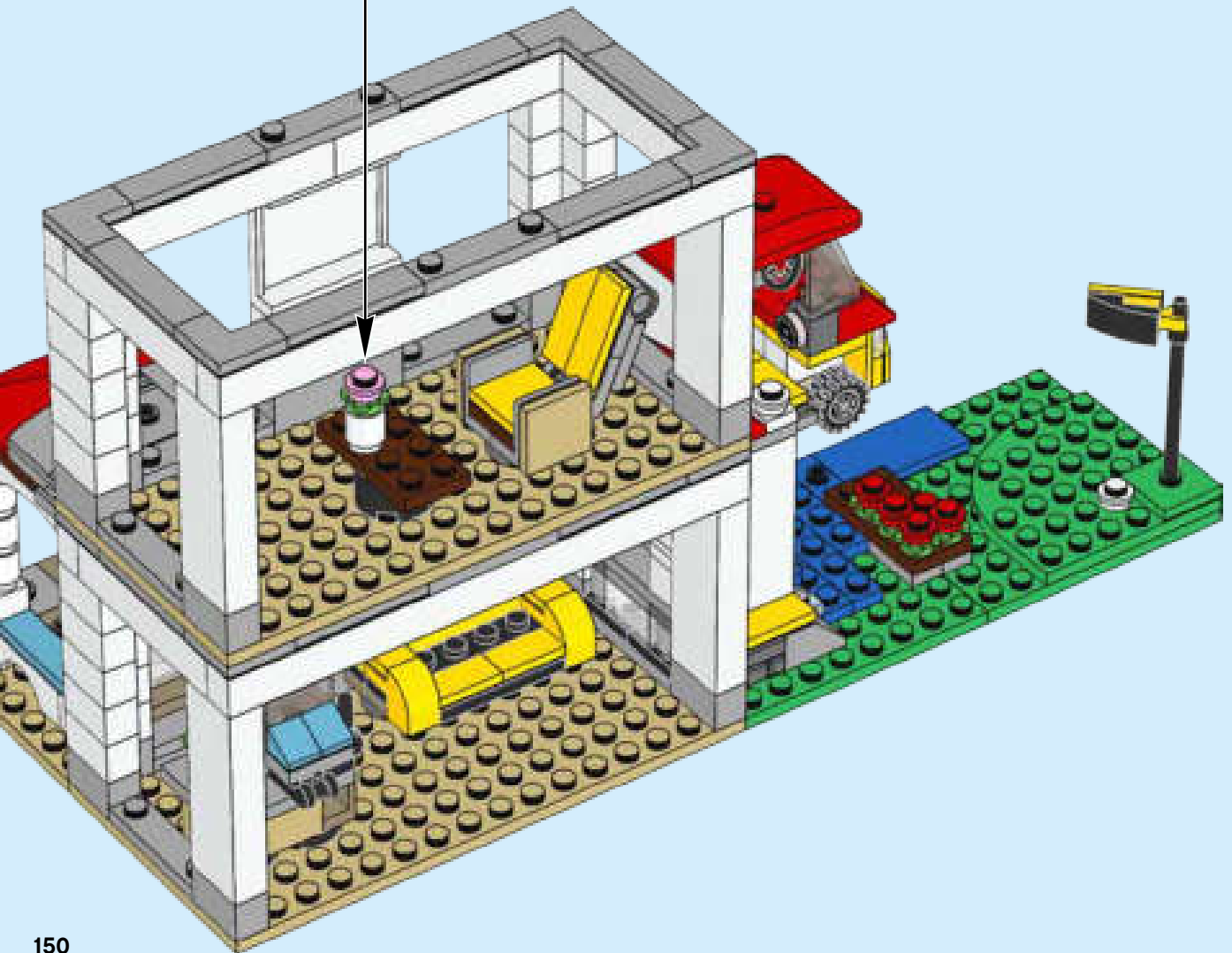

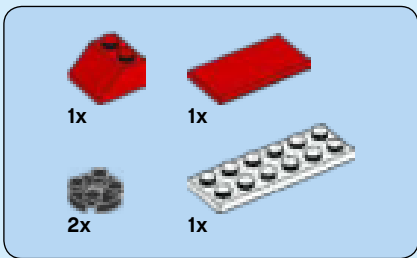

# 106

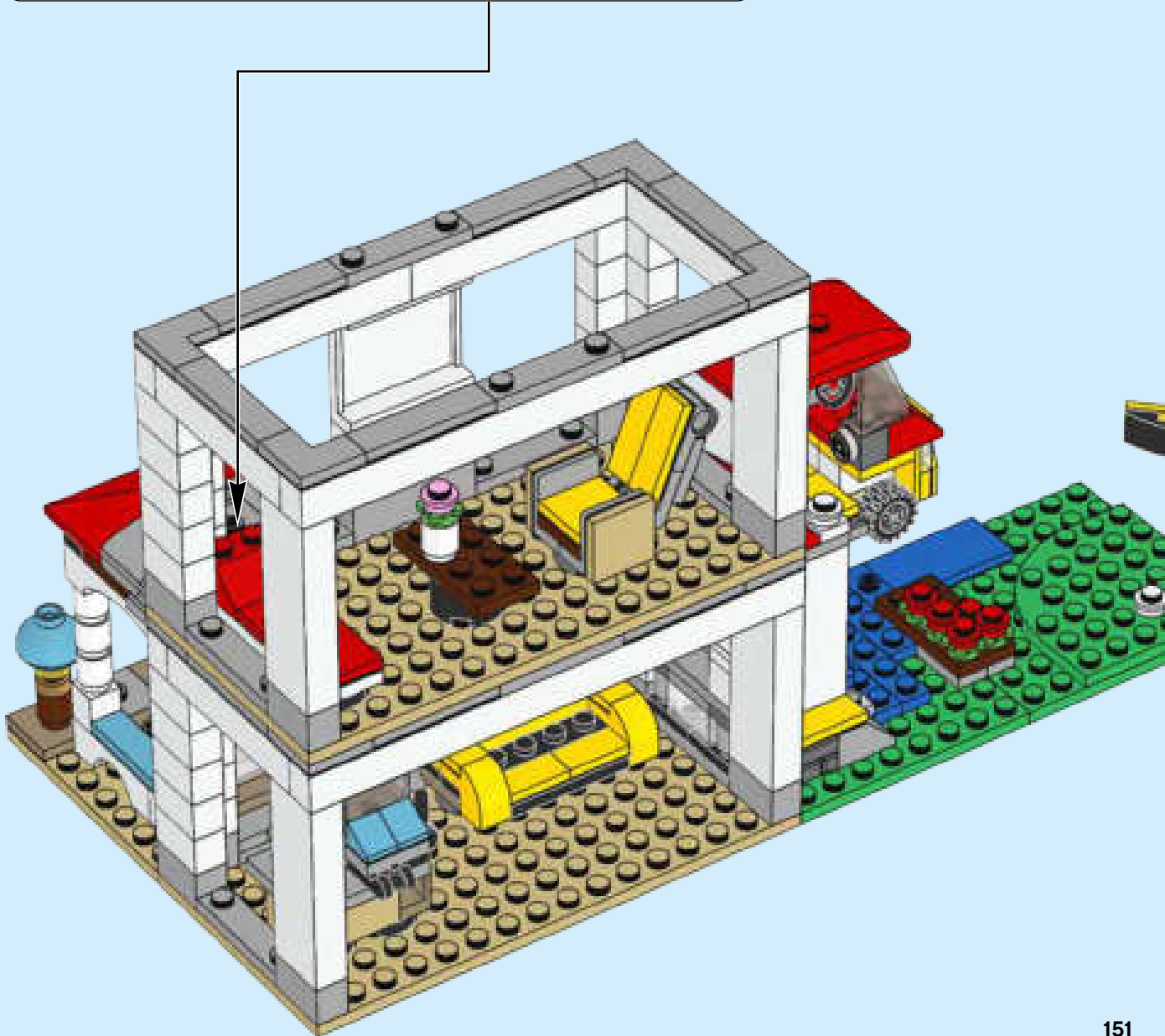
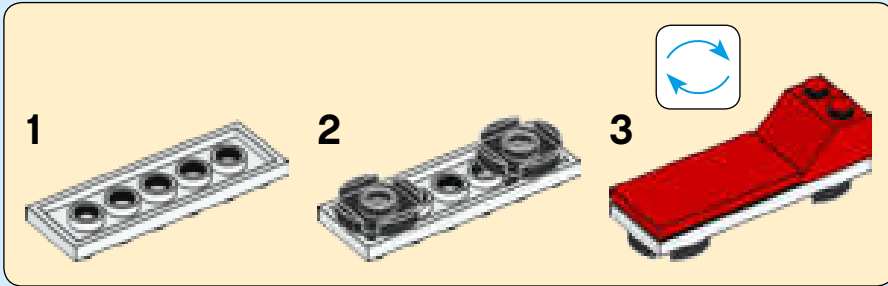

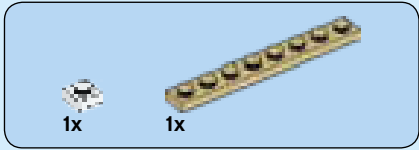
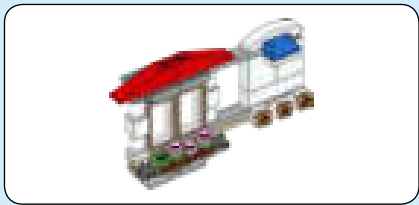

107

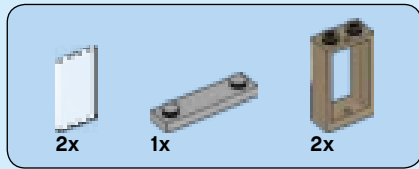
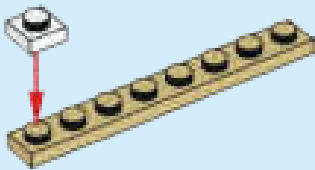

108

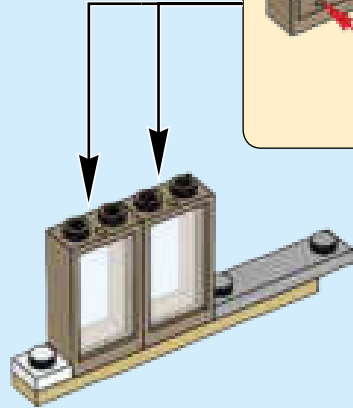
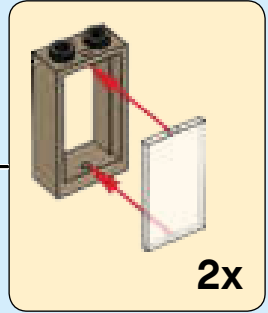

109

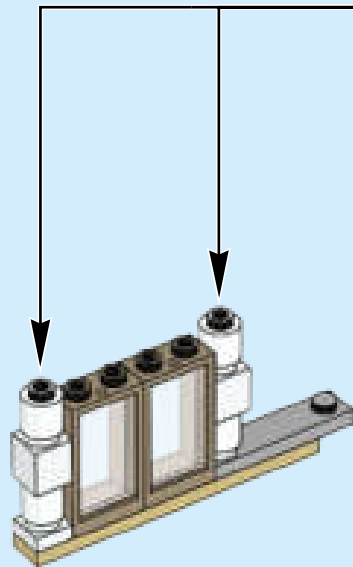
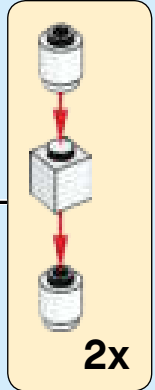



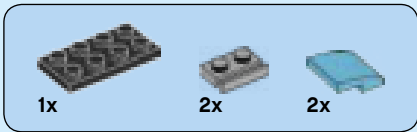

110

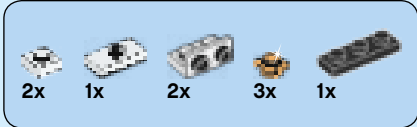
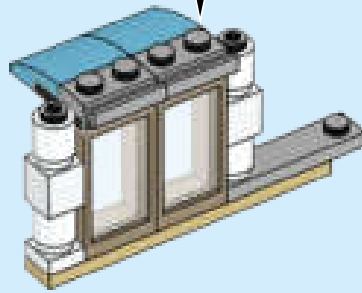
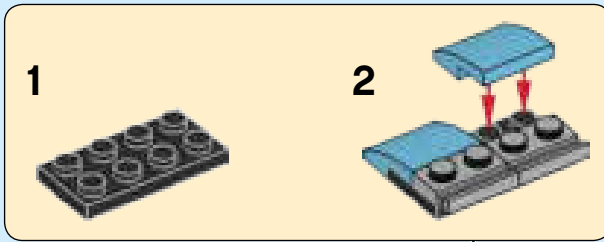

111

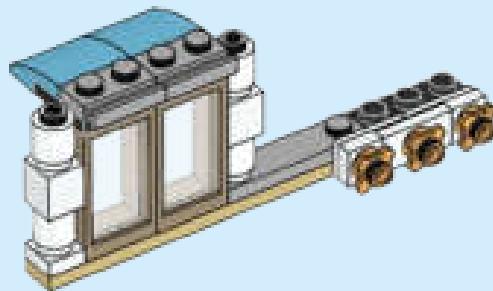
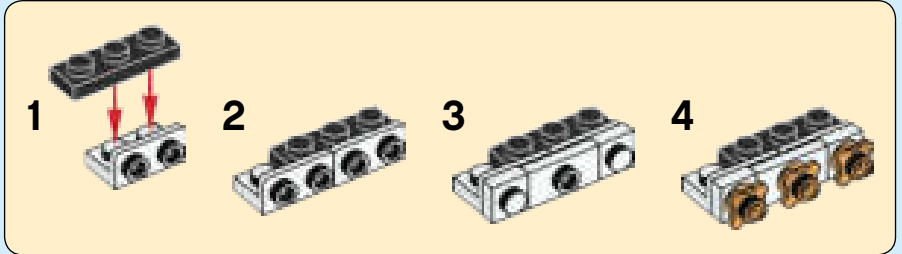

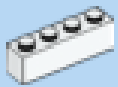

1x

# 112

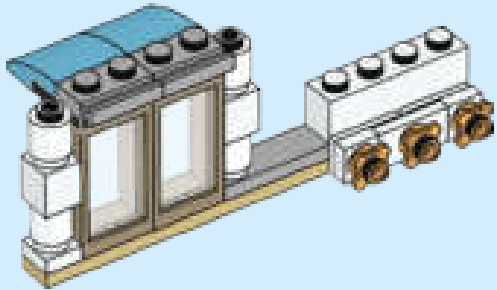

2x

# 113

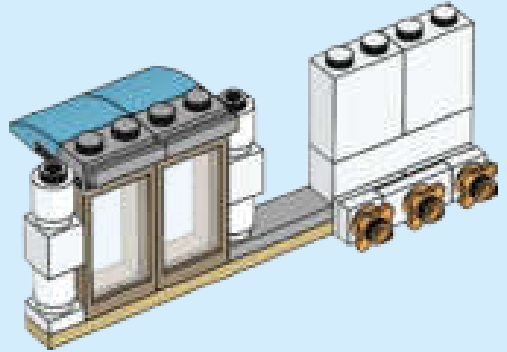

1x



1x

# 114

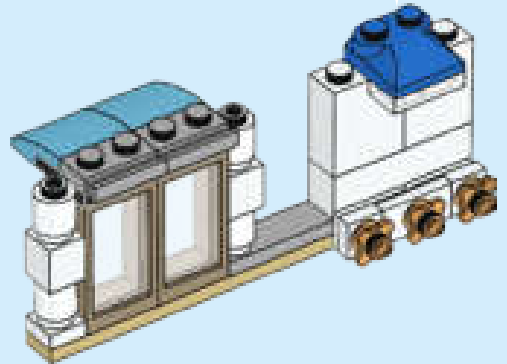
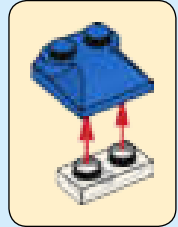

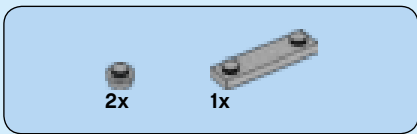

115

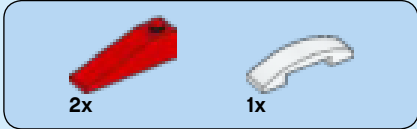
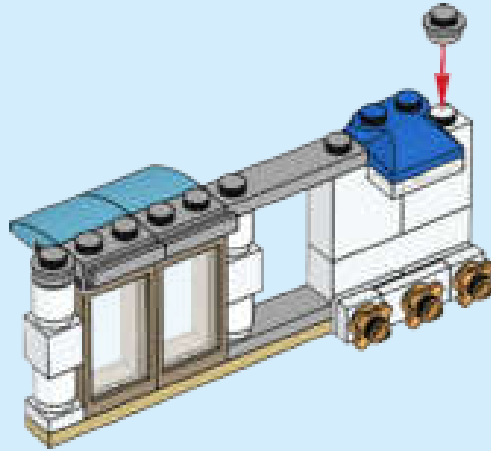

116

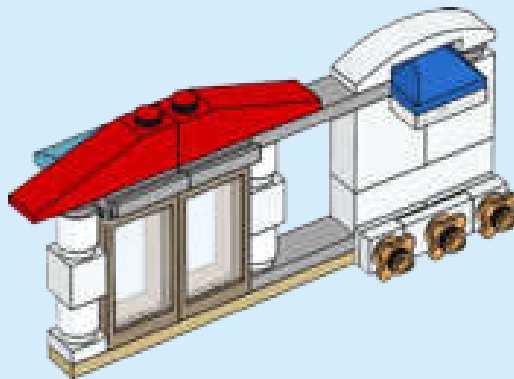

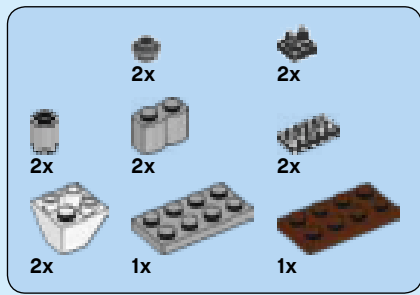

117

1

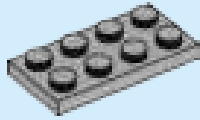

2

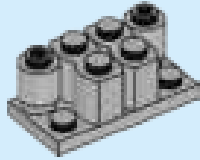

3

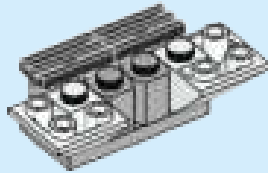

4

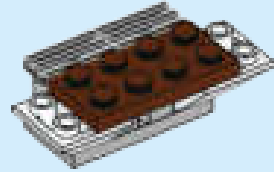

5

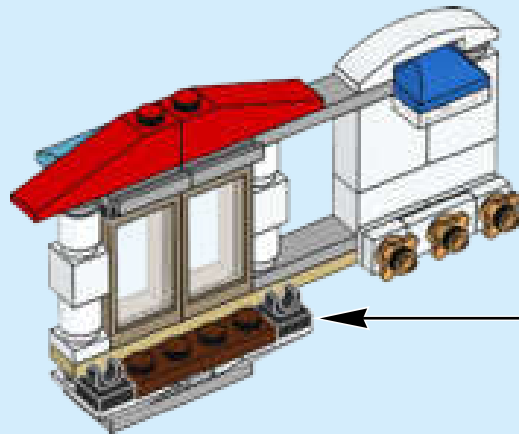
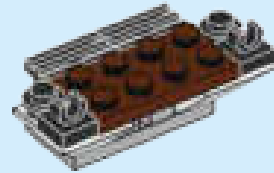

3x 3x

118

2x

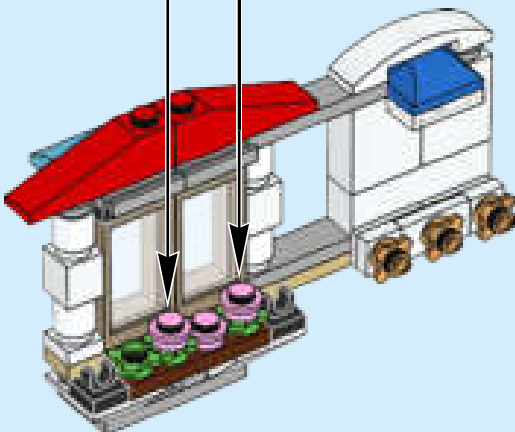

119

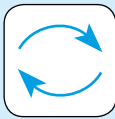

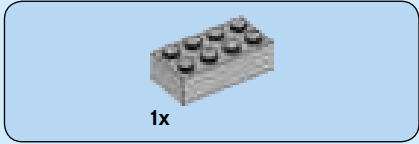

120

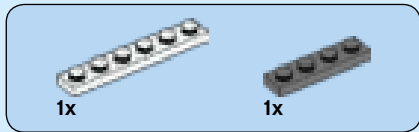
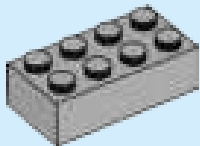

121

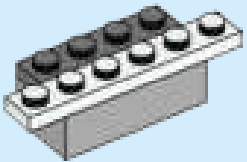

122



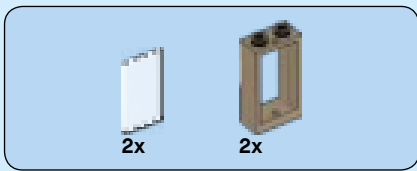

123

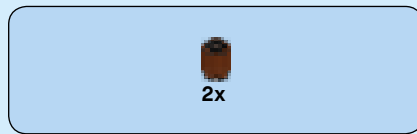
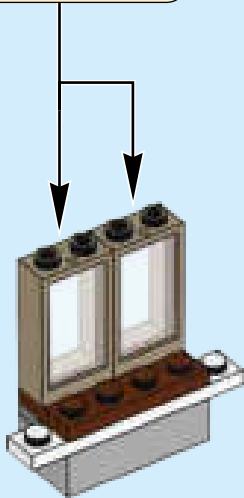
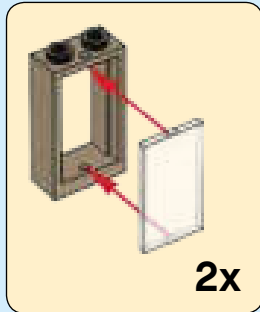

124

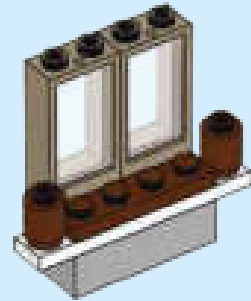

125

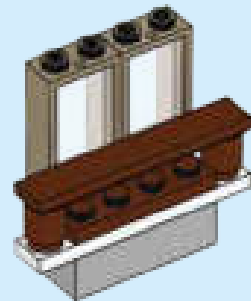

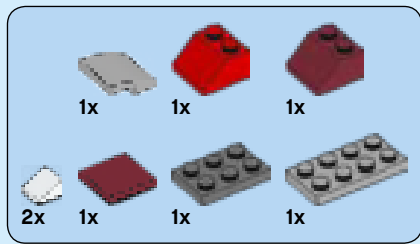

# 126

1



2

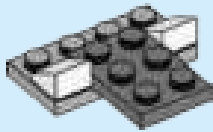

3

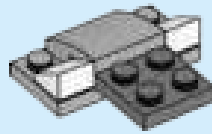

4



5

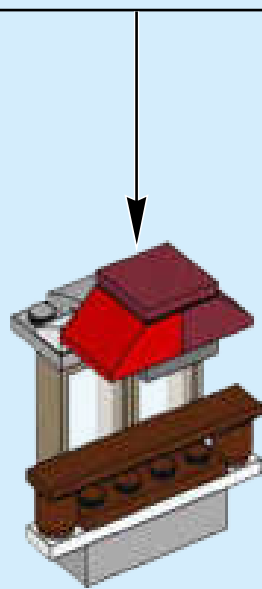
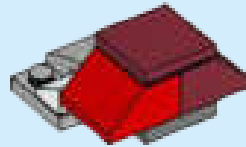

**2x**



127

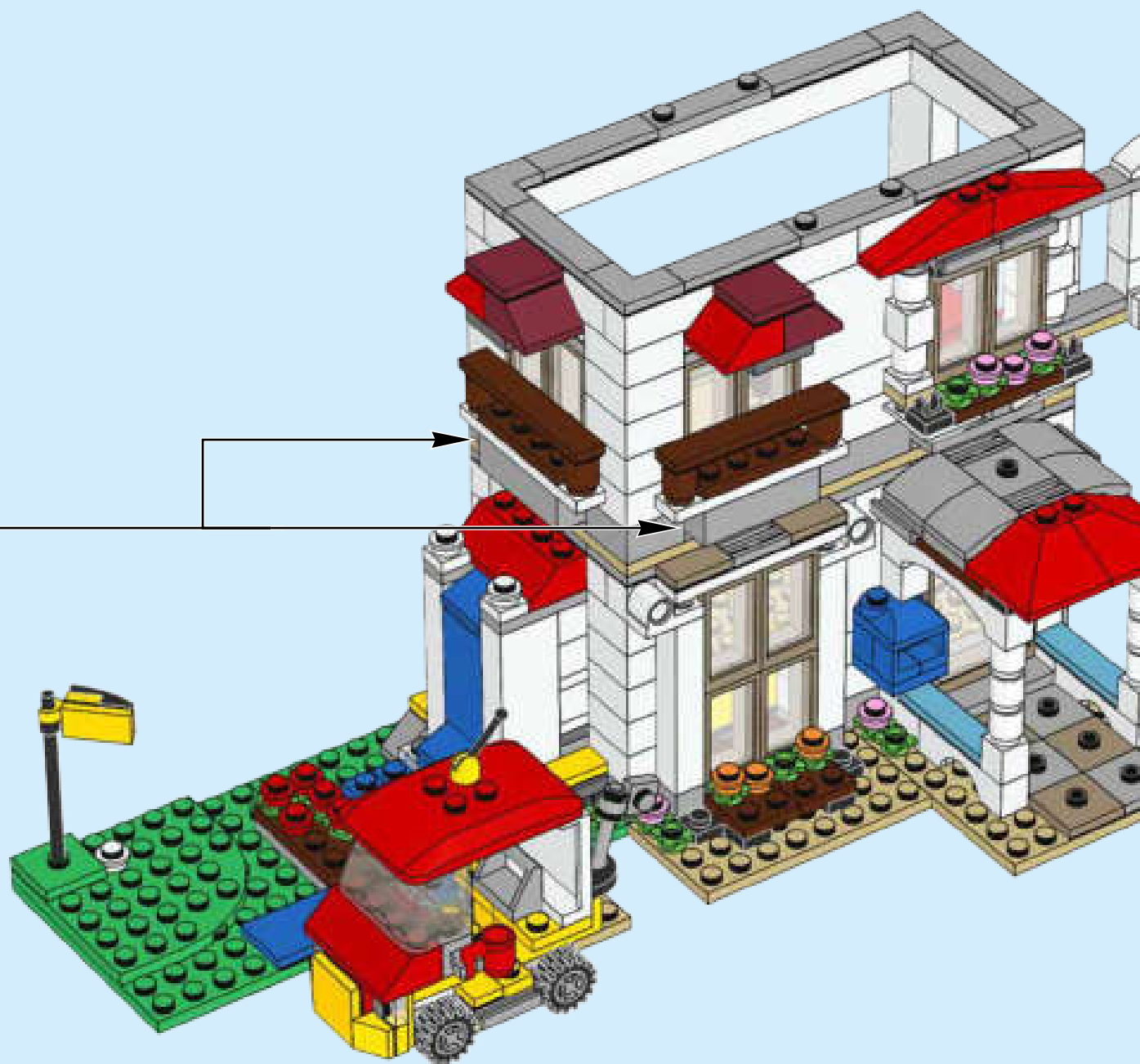

128

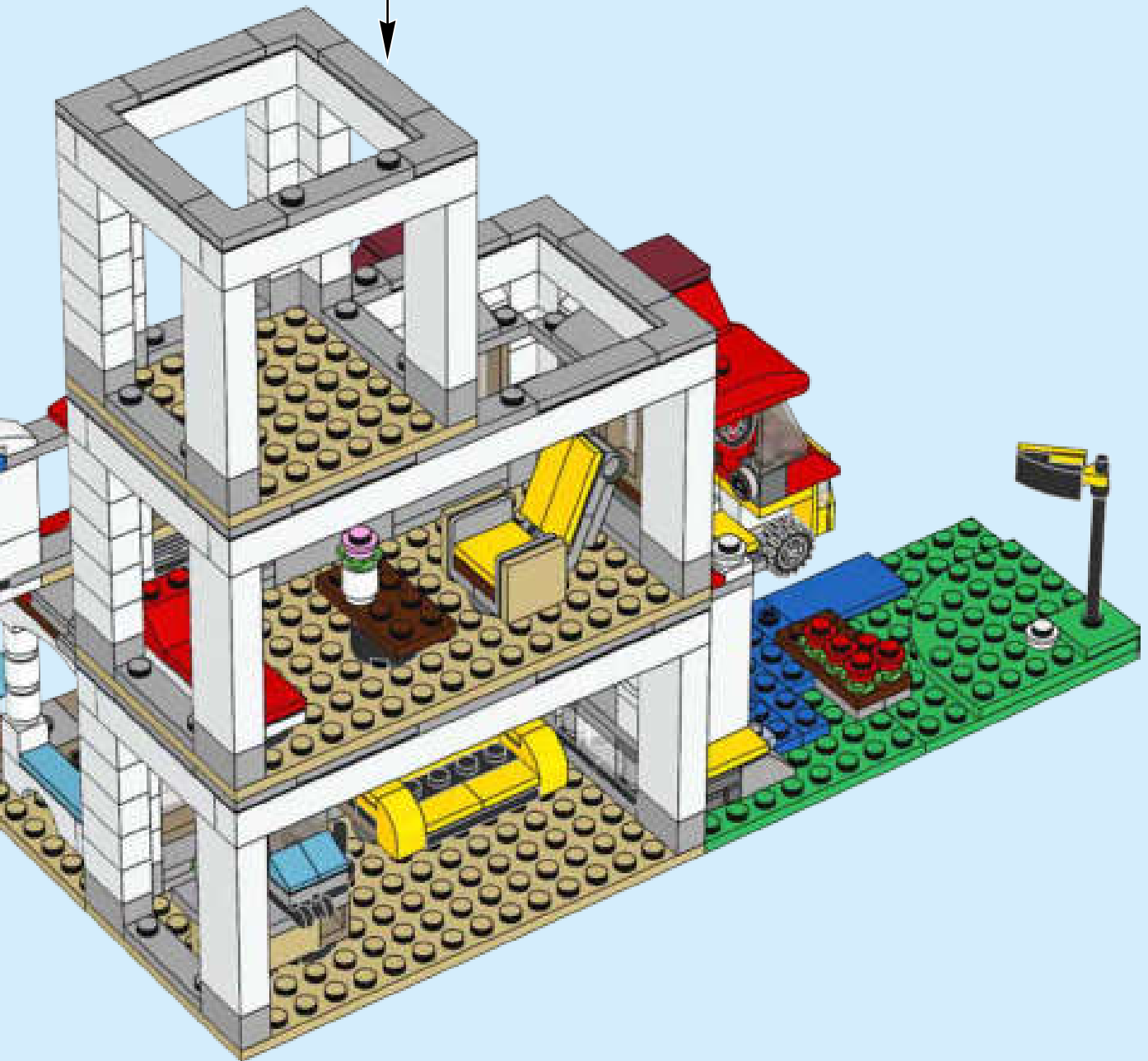
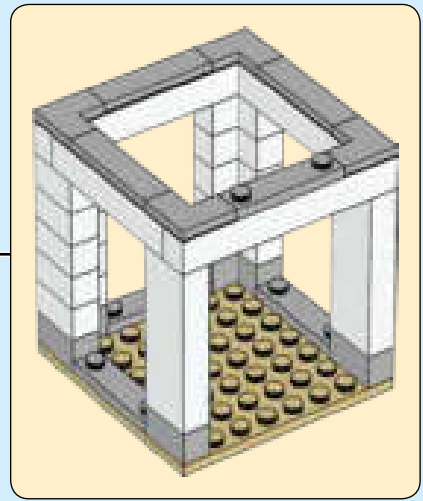
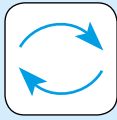

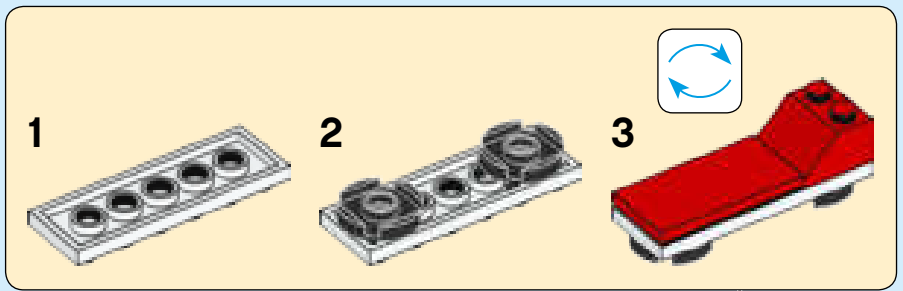
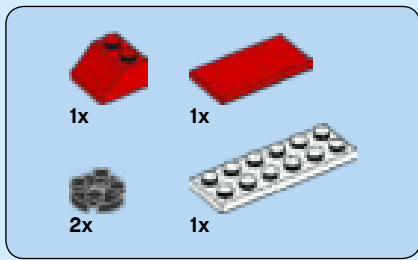

129

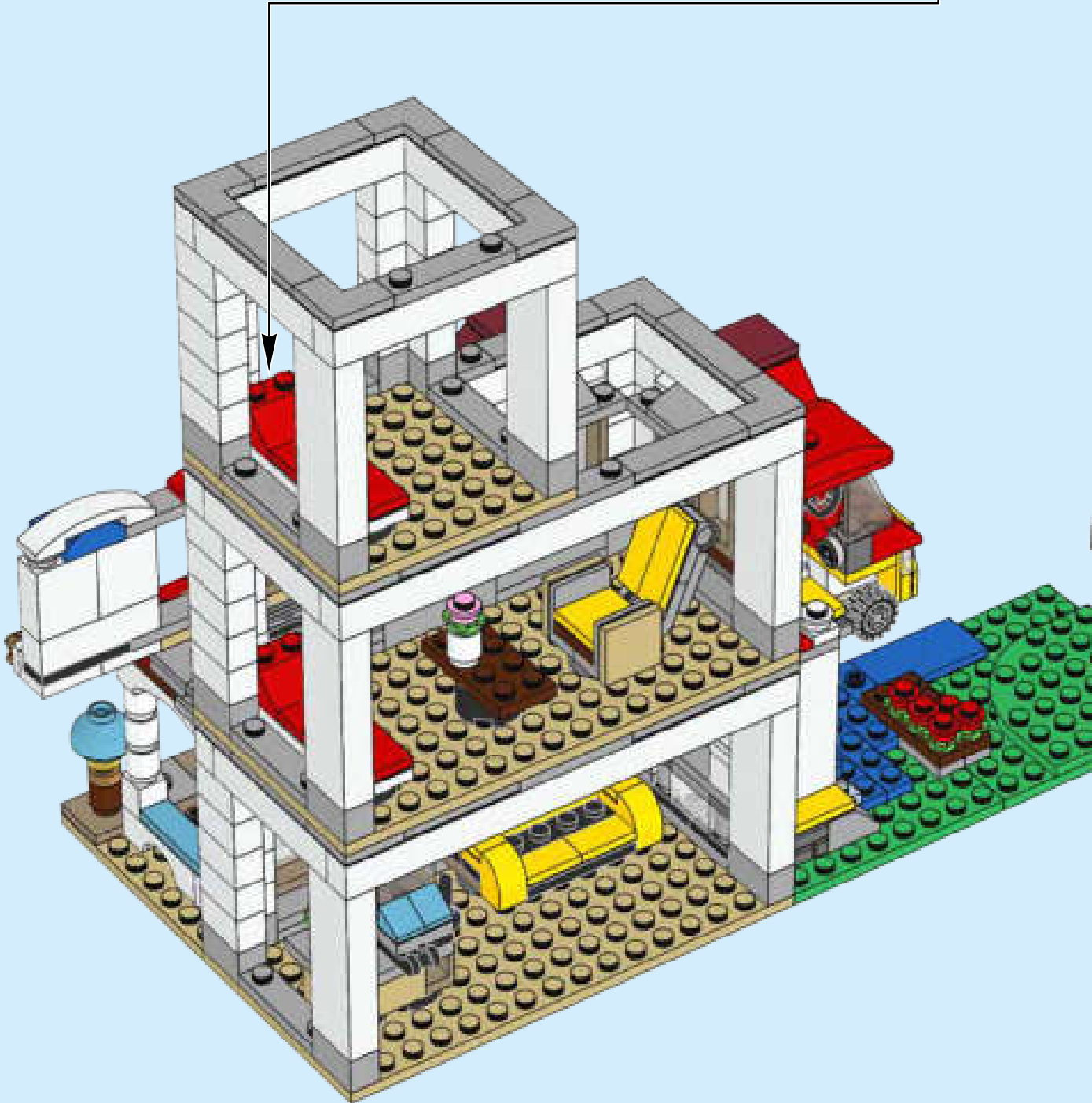

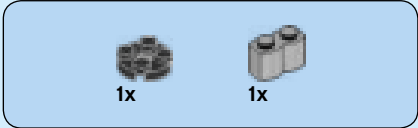
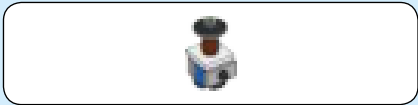

130

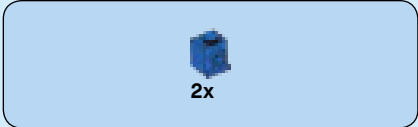

131

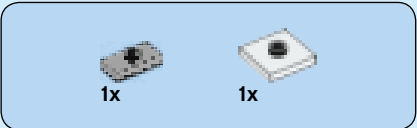

132

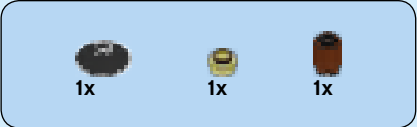

133



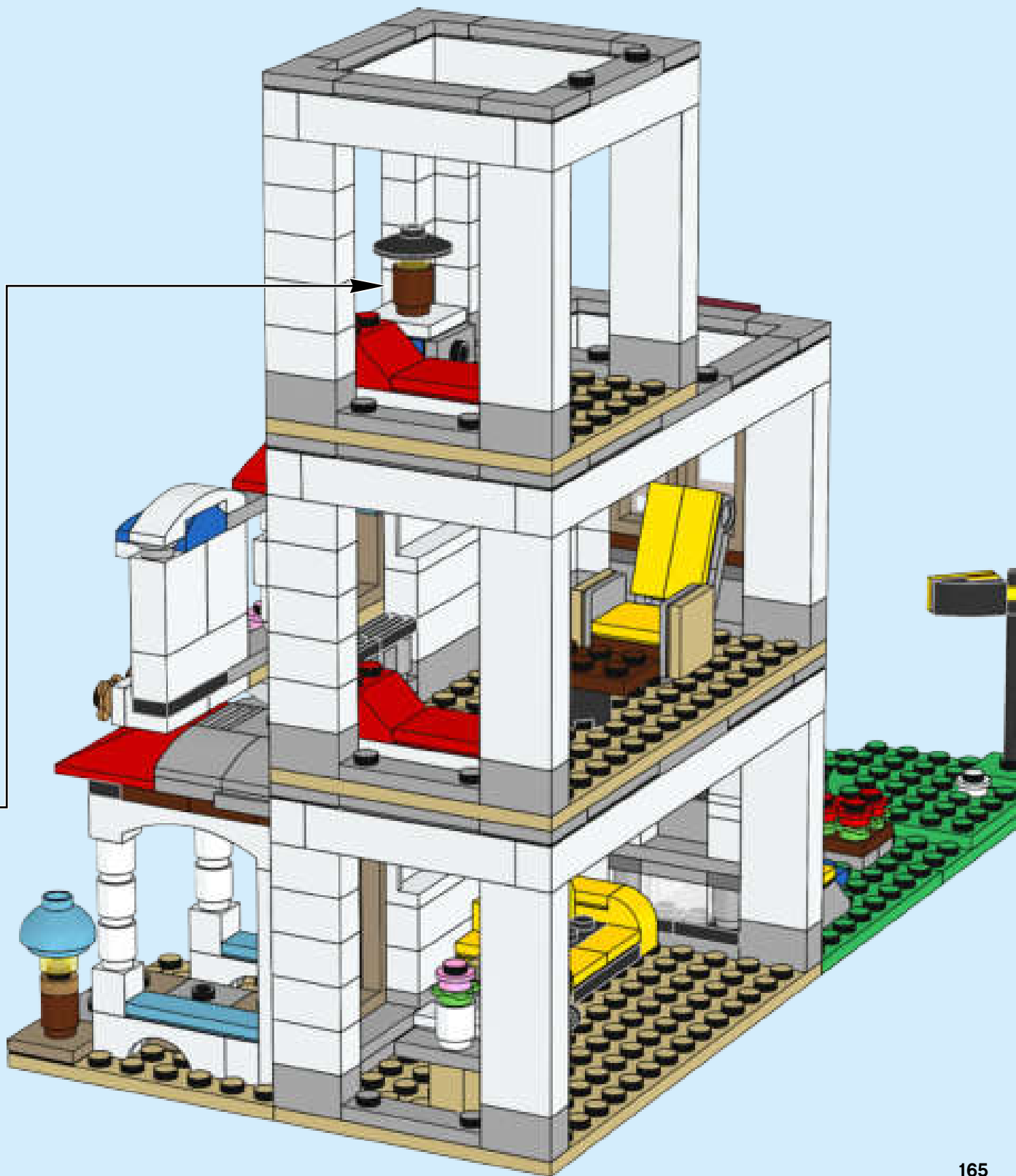

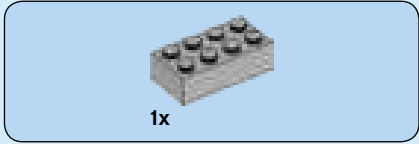

**135**

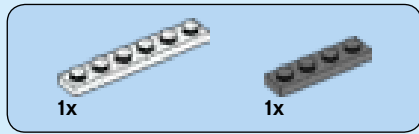
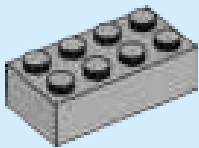

**136**

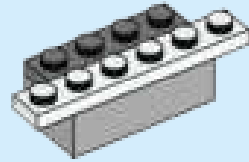

**137**

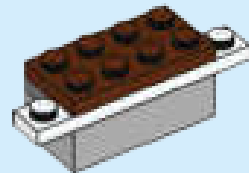

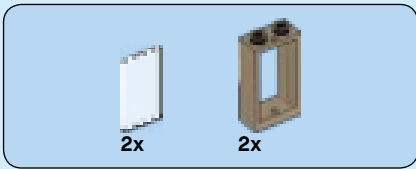

138

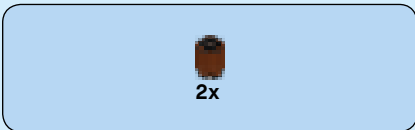
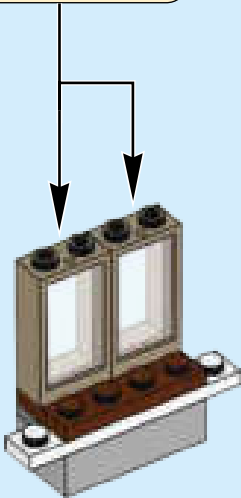
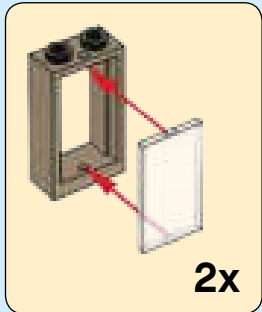

139

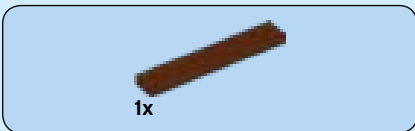
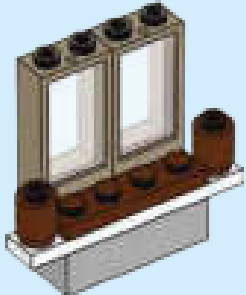

140

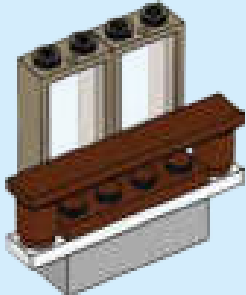

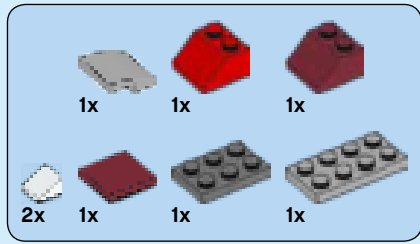

# 141

1

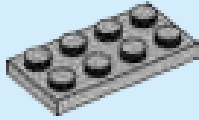

2

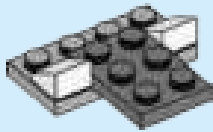

3

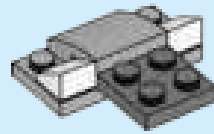

4



5

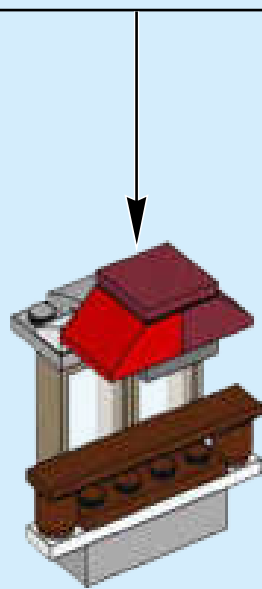
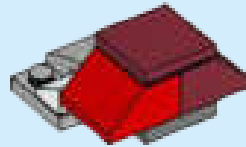



142

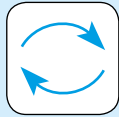

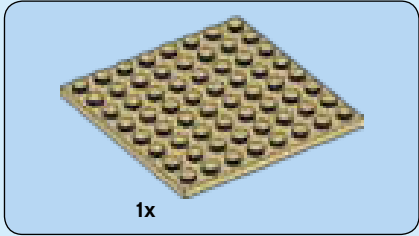

143

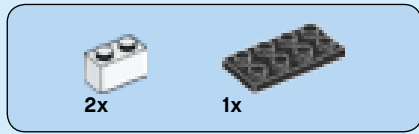
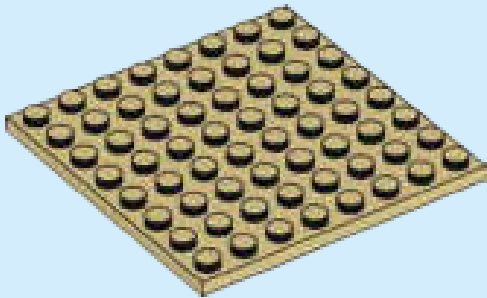

144

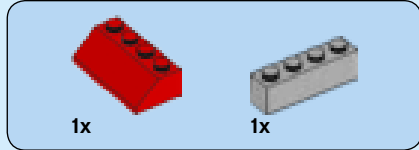
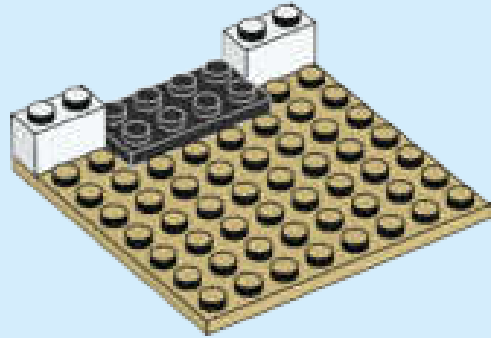

145

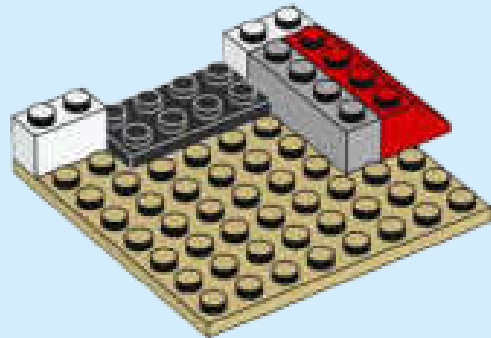

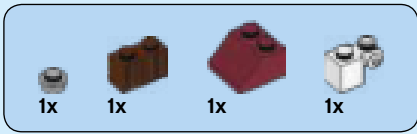

146

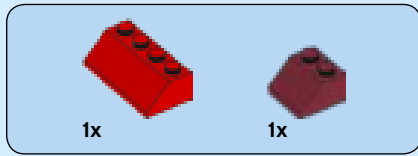
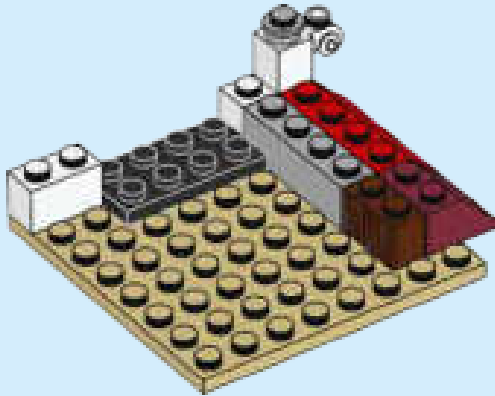
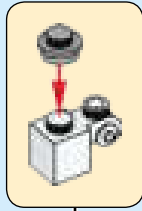

147

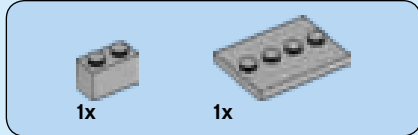
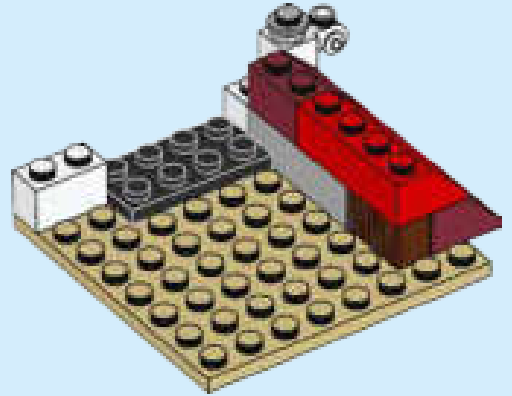

148

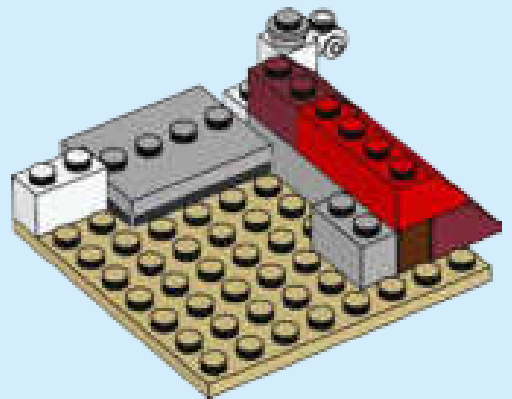

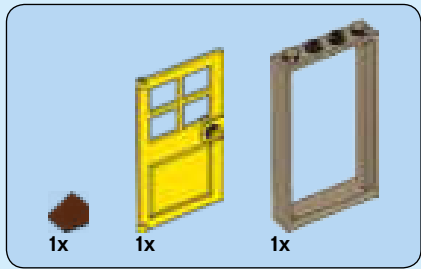

# 149

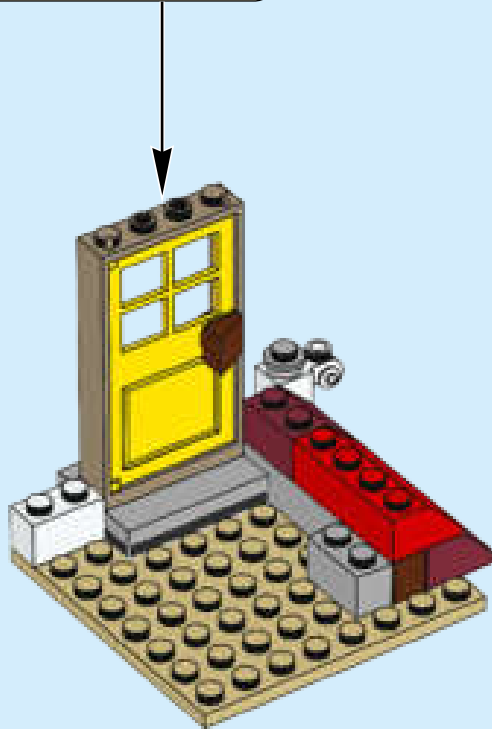
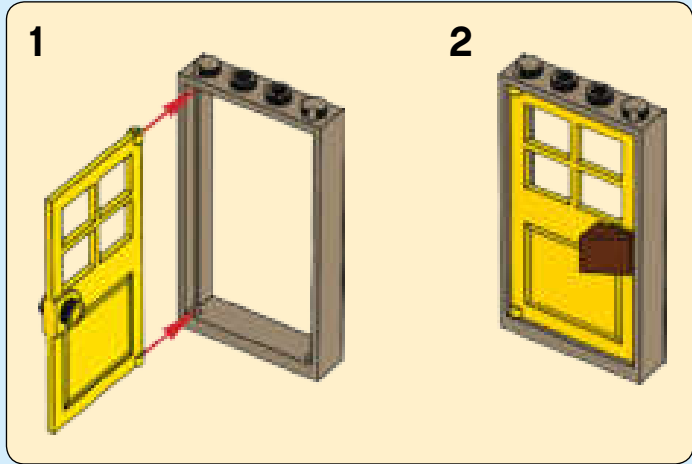

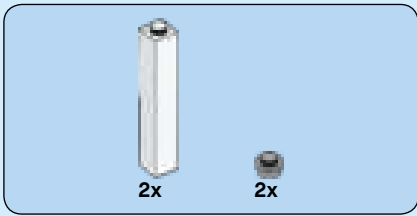

150

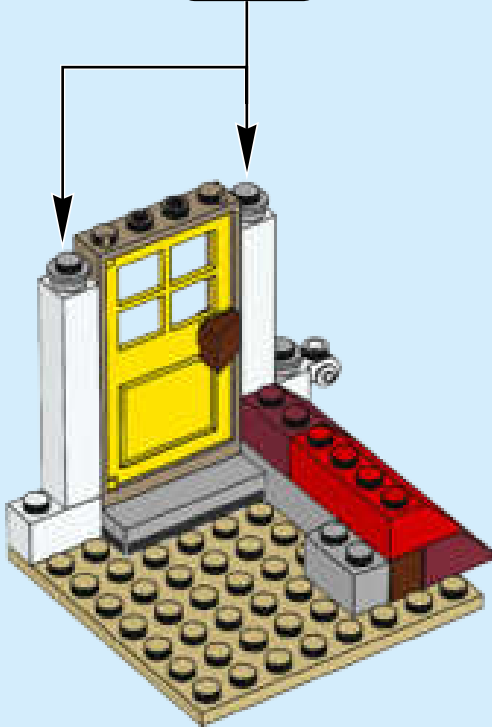
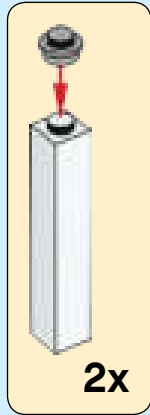

151

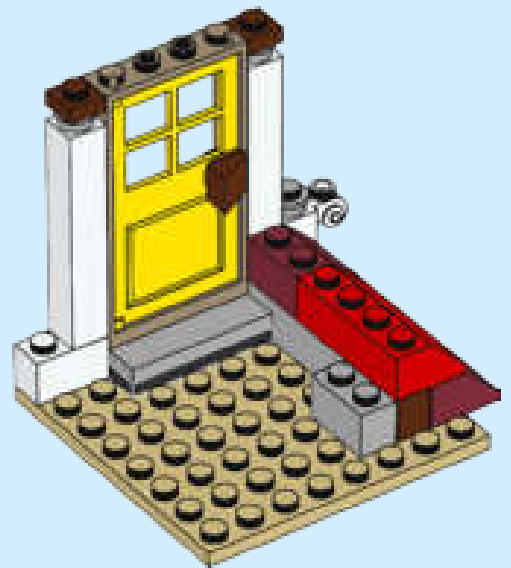

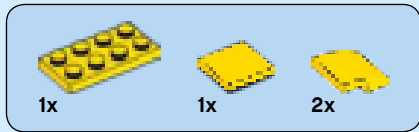

# 152

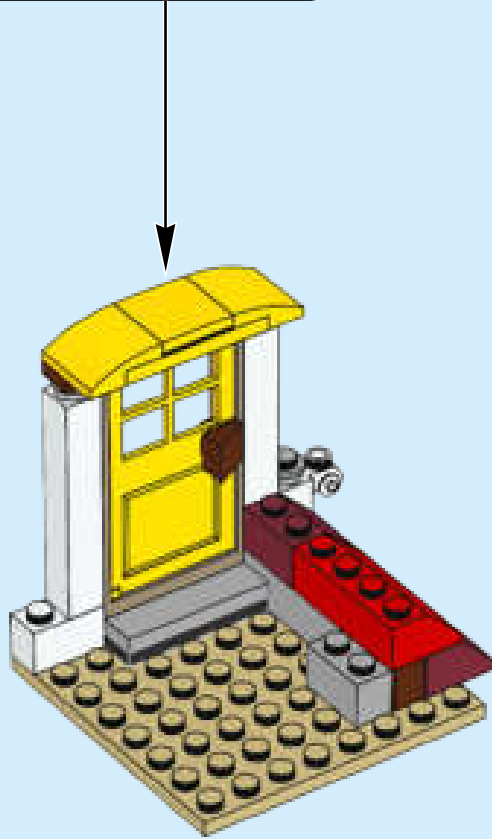

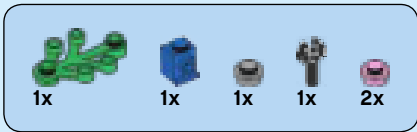

153

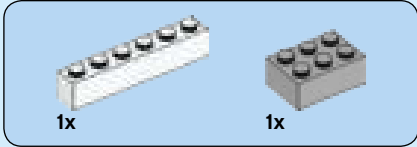
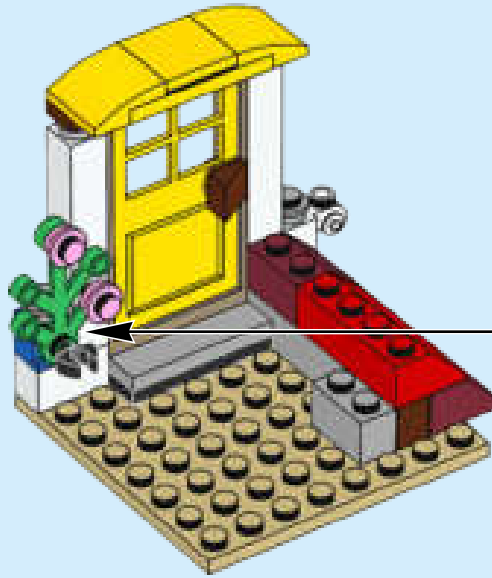
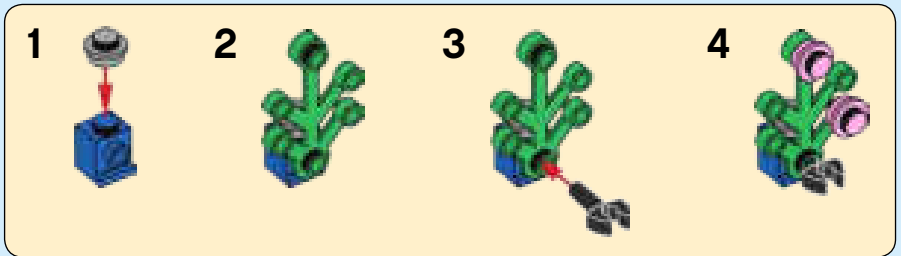

154

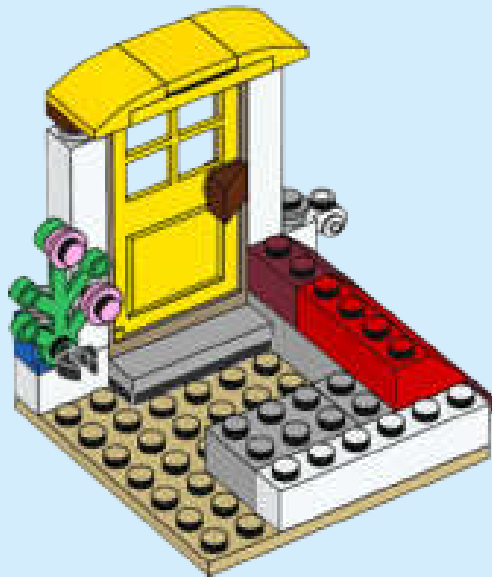

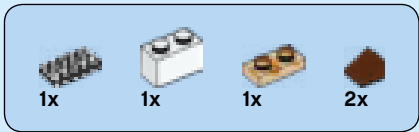

# 155

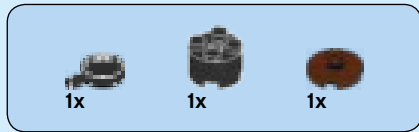
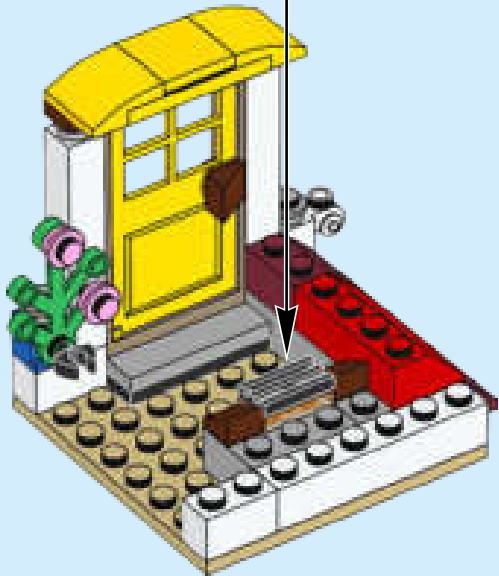

# 156

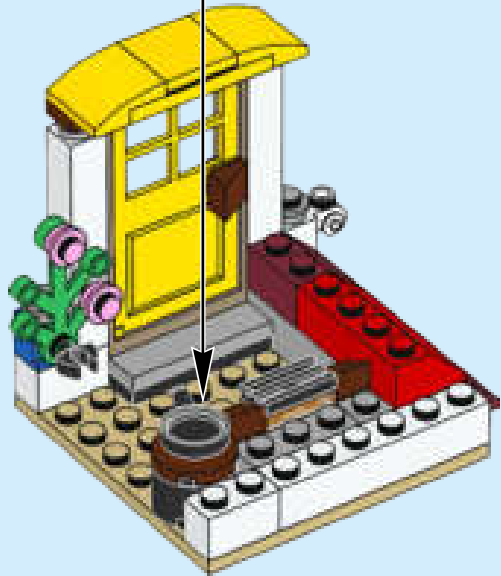
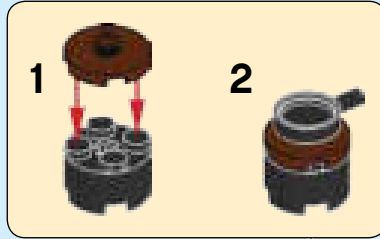



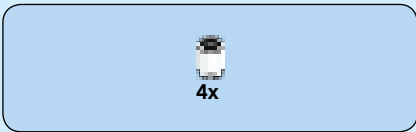

# 157

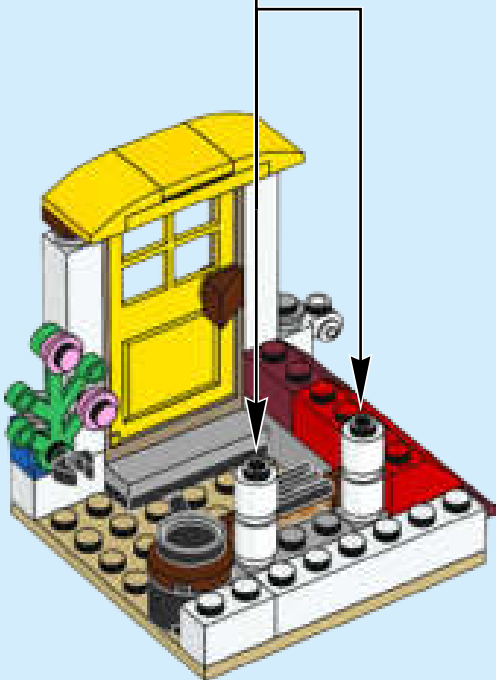
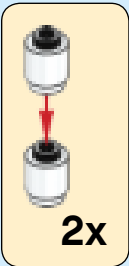

# 158

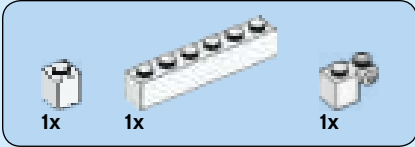
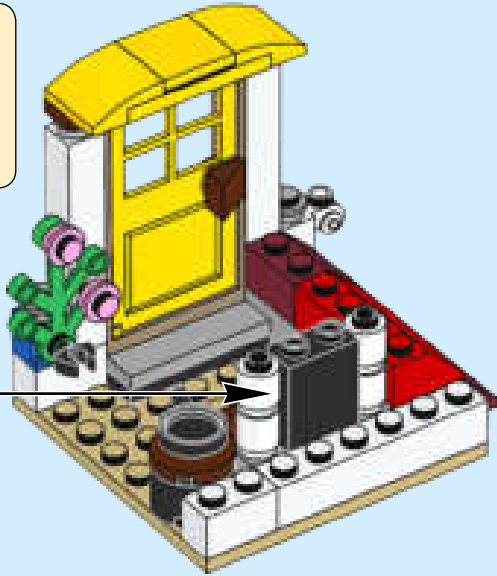

# 159

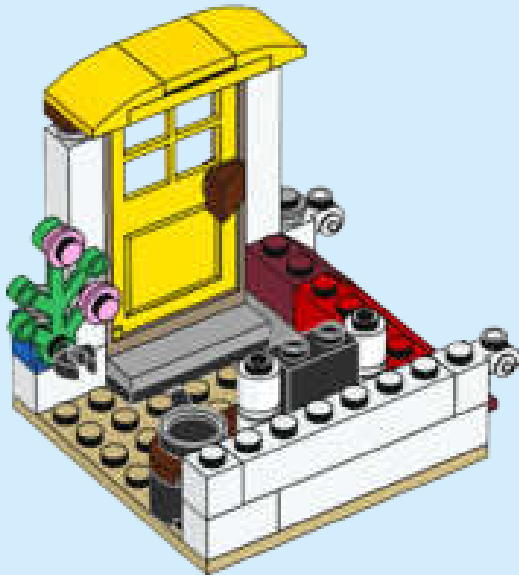

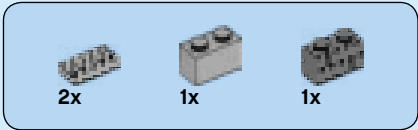

# 160

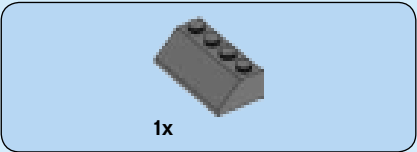
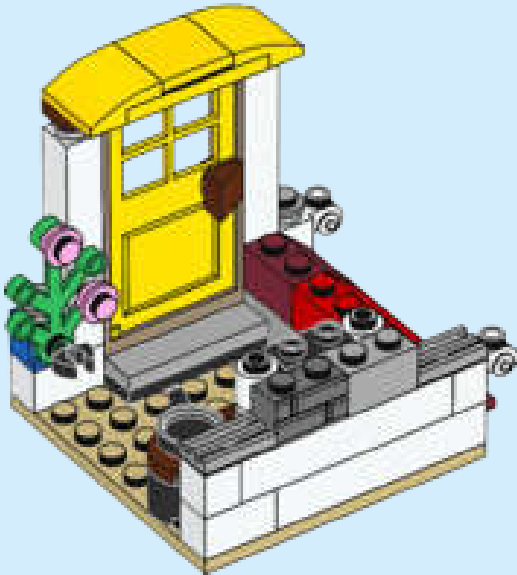

# 161

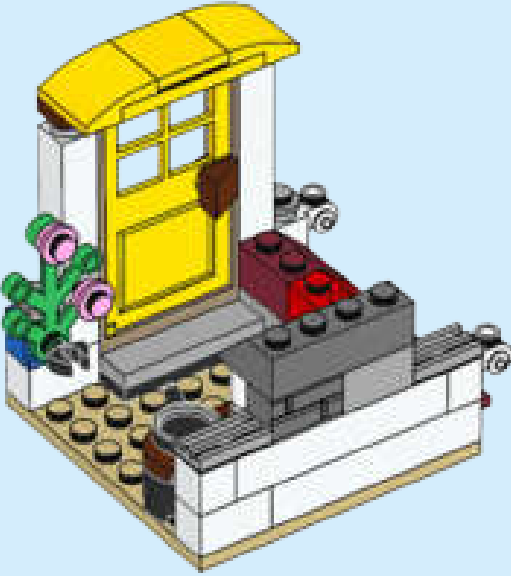

# 162

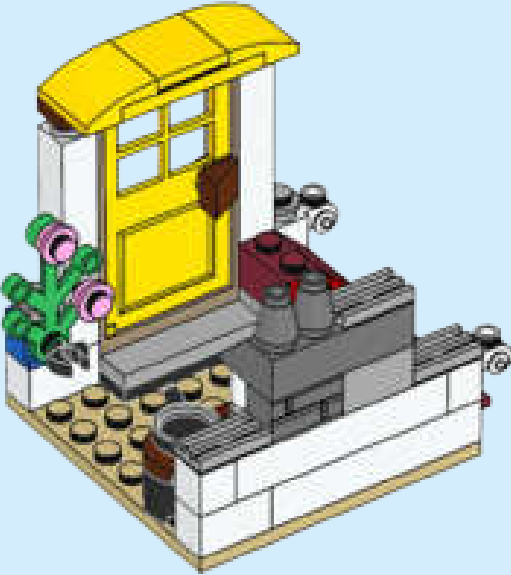

163

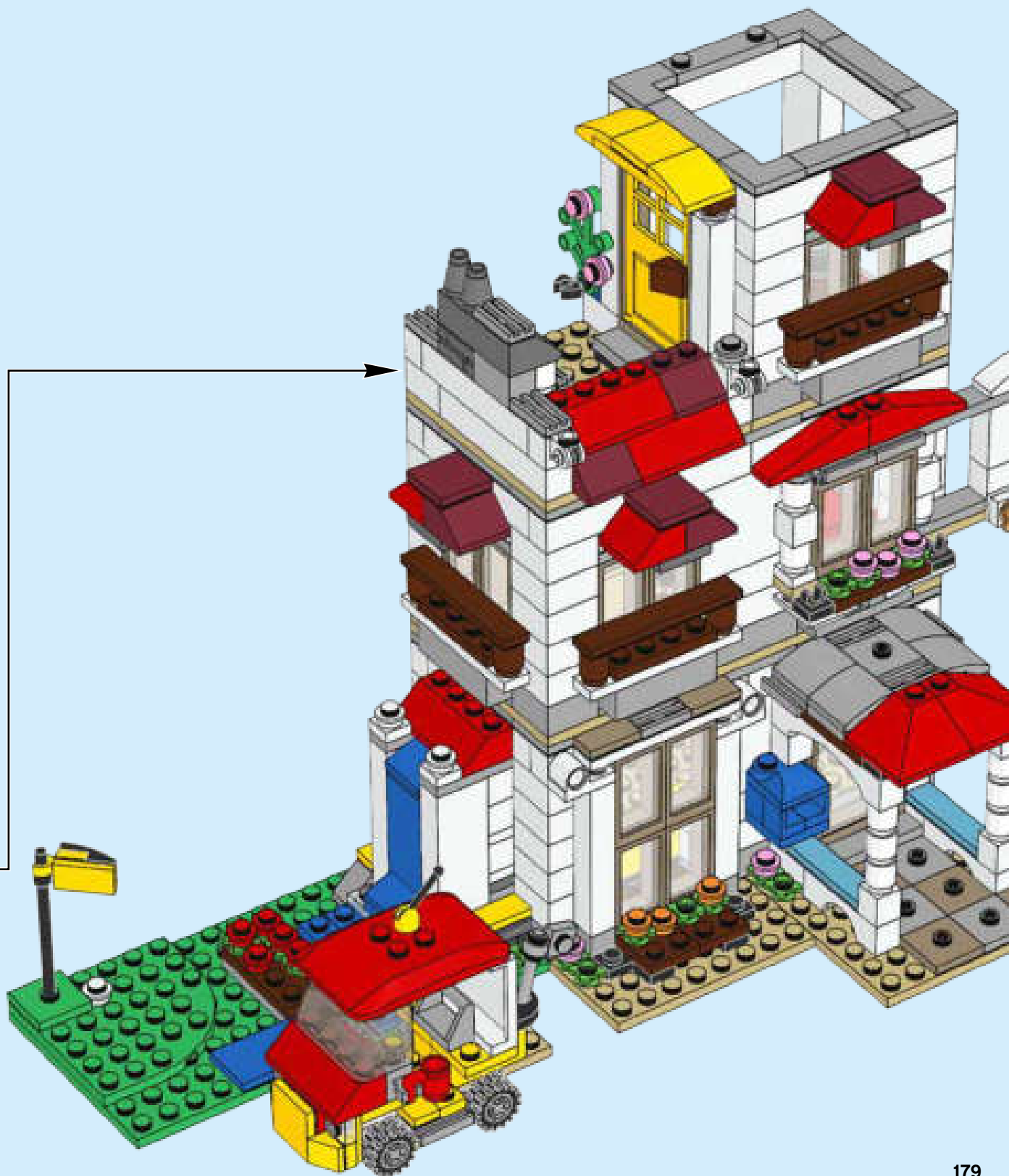

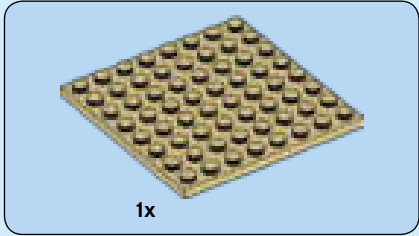
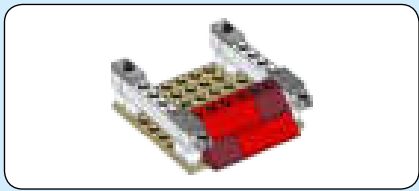

1x

# 164

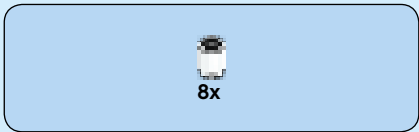
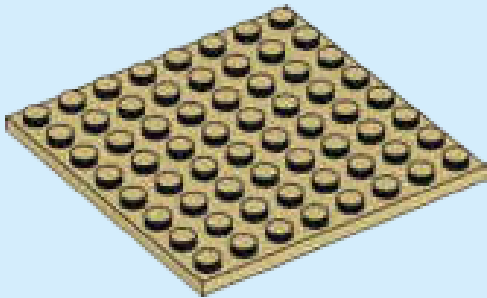

8x

# 165

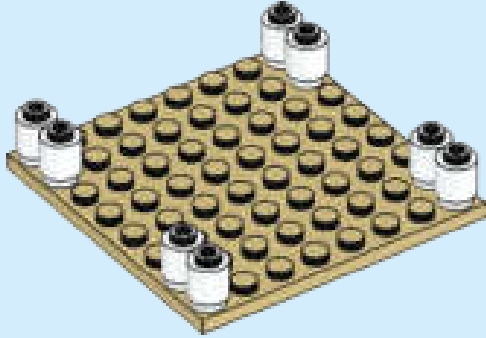

1x

1x

# 166

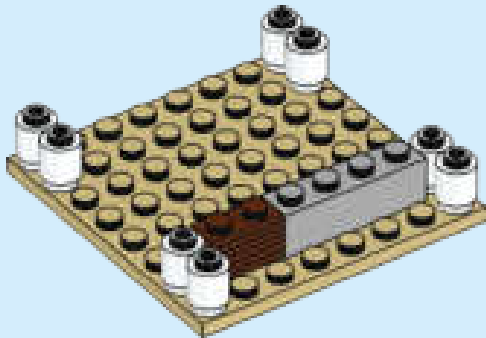

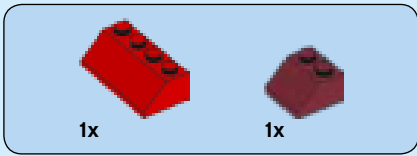

167

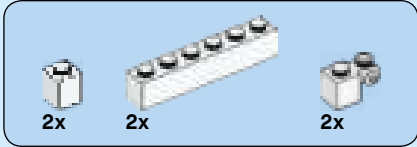
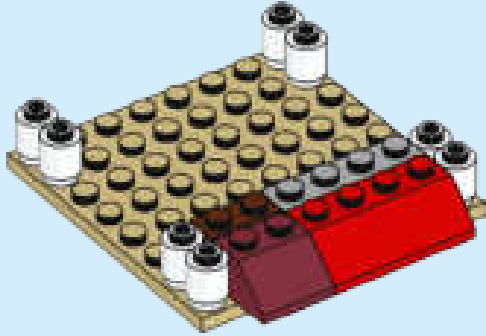

168

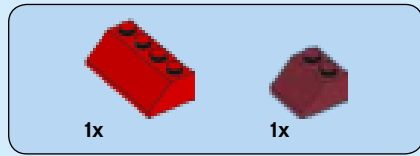
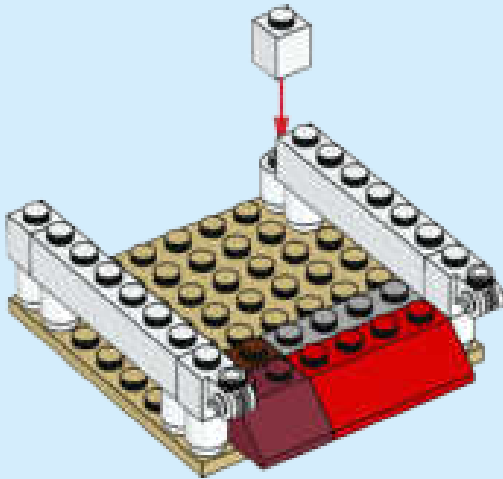

169

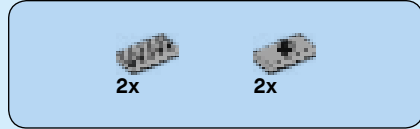
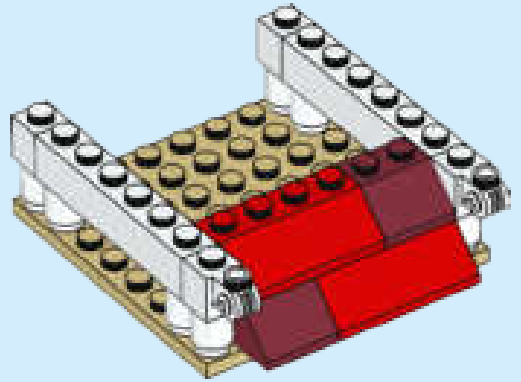

170

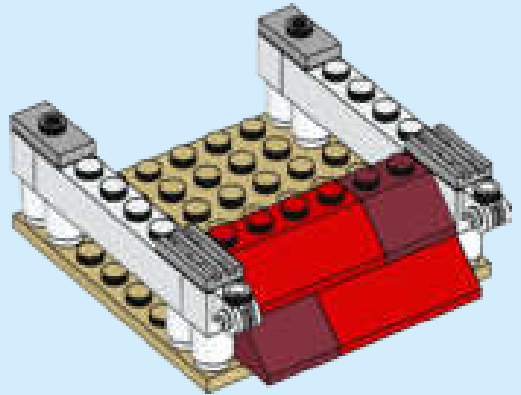







CREATOR

3<sup>IN</sup>1



31068

=



MODULAR  
MODULAIRE  
MODULARE  
MODULÁRIS  
模块化



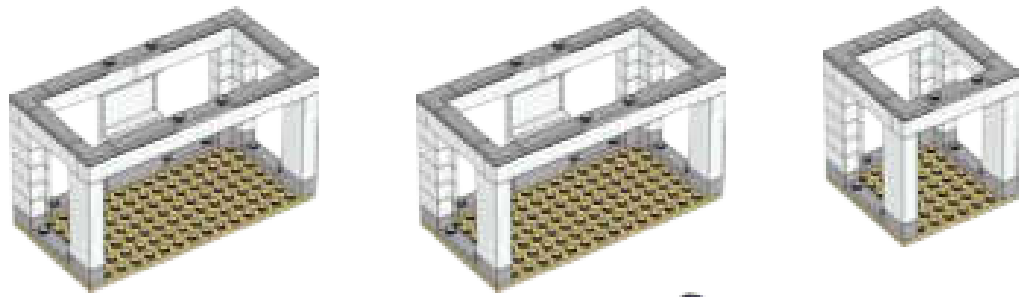

+



+



+



+



+



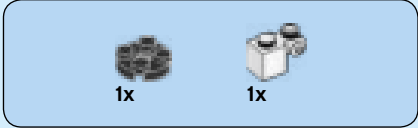
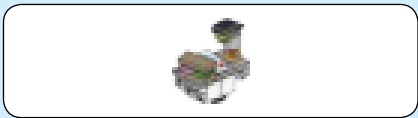

**1**

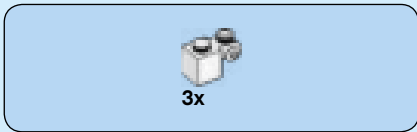

**2**

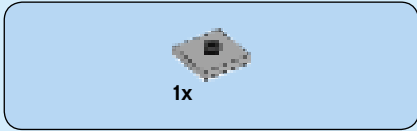
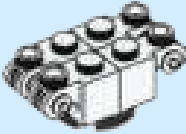

**3**

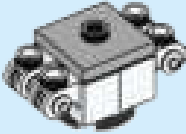

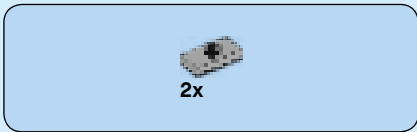

4

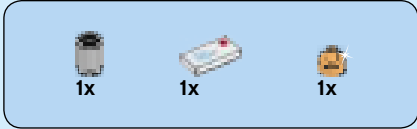
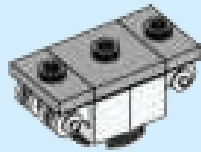

5



6

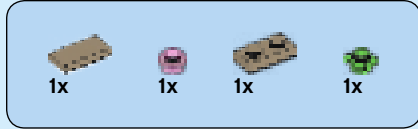
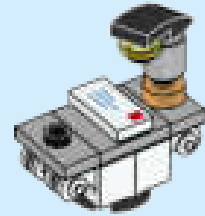
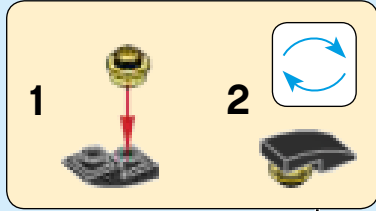

7

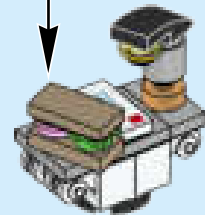

8

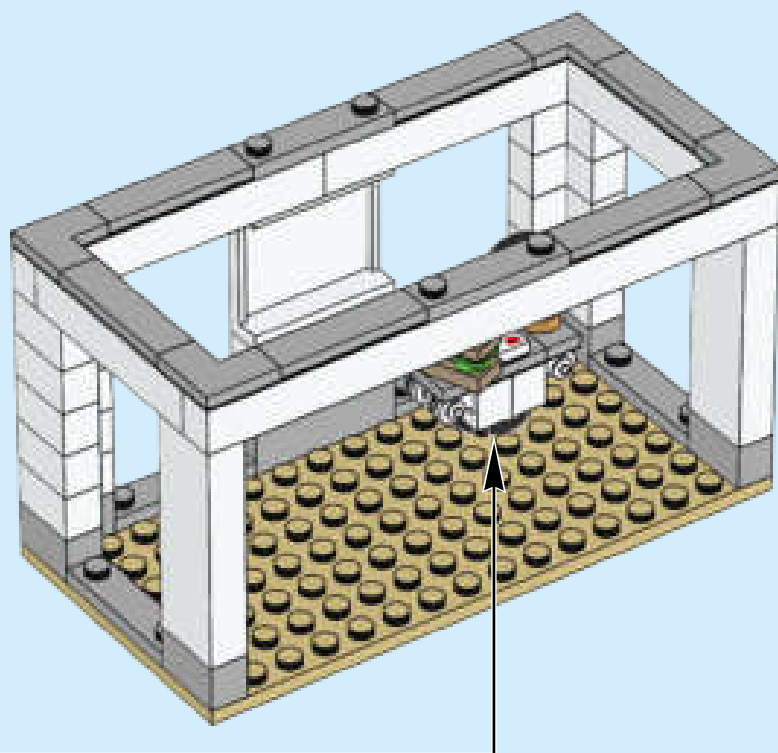

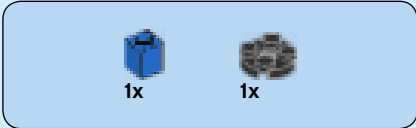

9



10



11



12



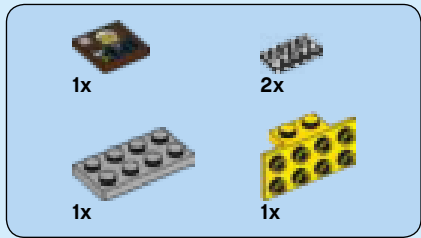

# 13

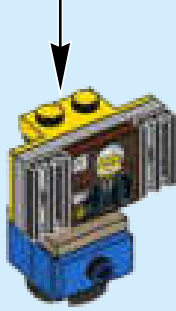
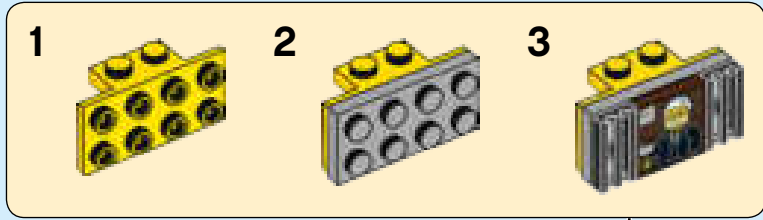

---

# 14

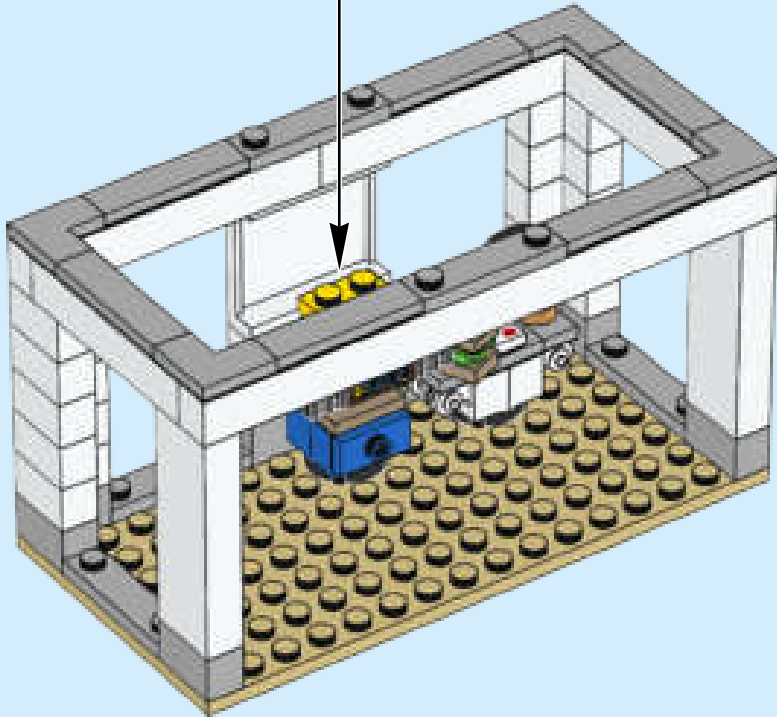



# 15

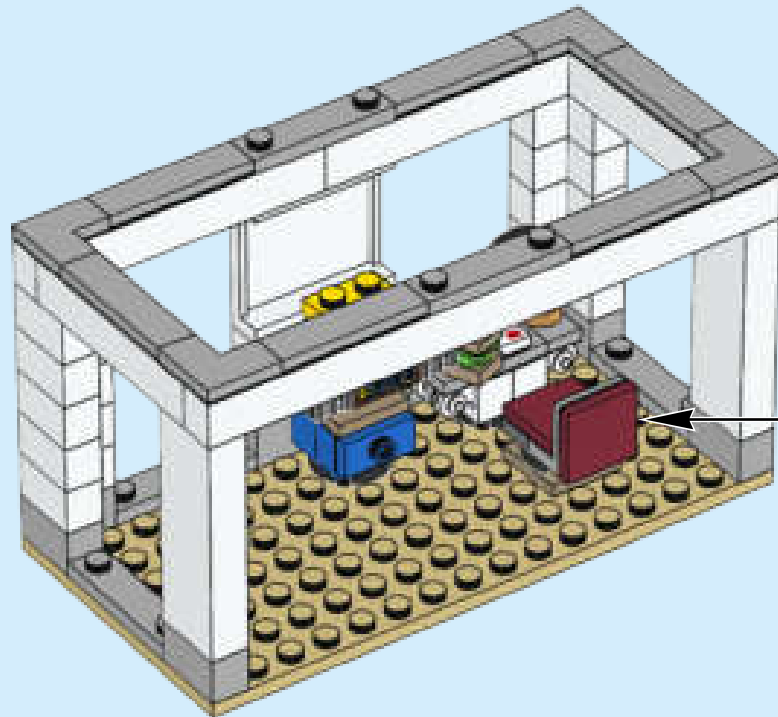

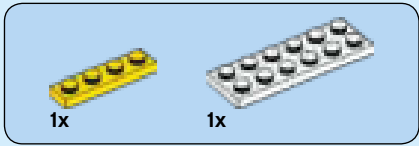

16

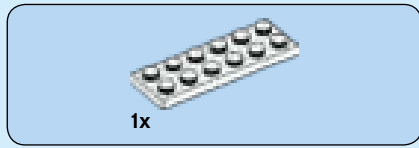
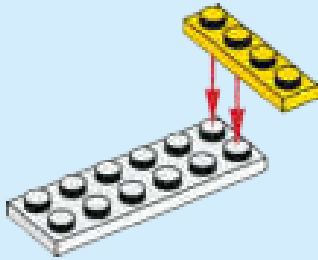

17

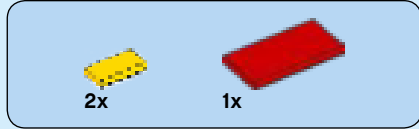
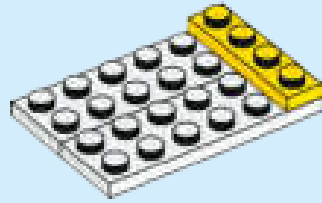

18

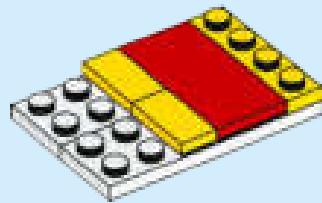



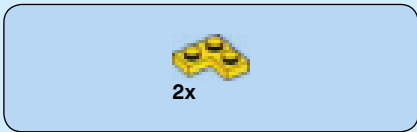

19

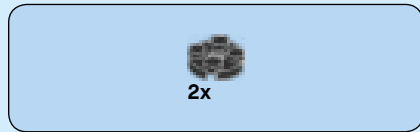
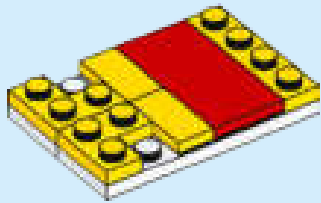

20

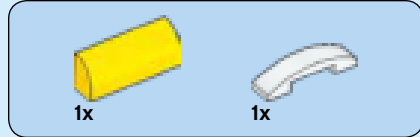
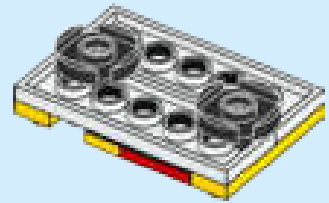
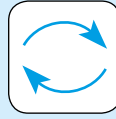

21

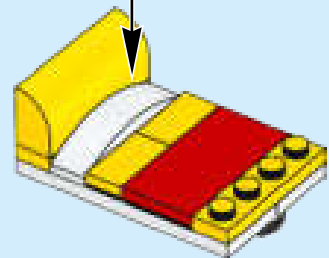
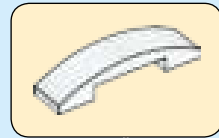
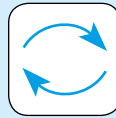

22

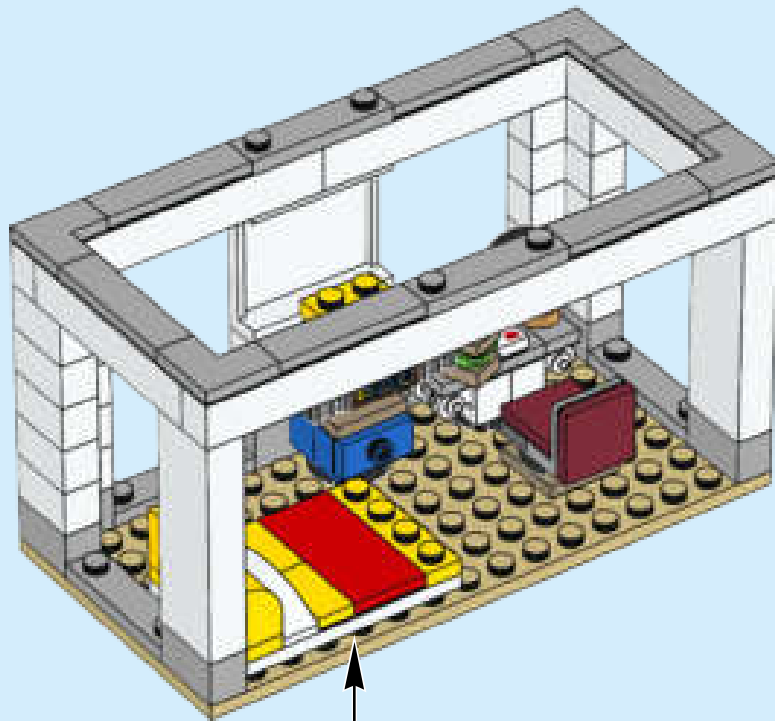

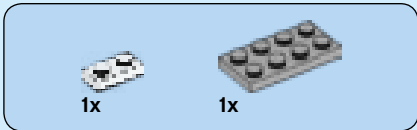

23

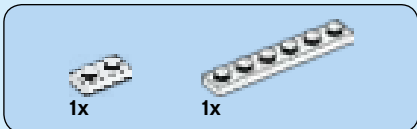
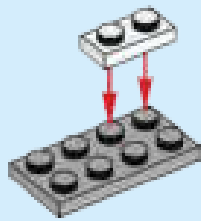

24

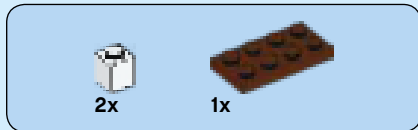
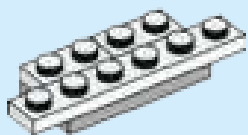

25

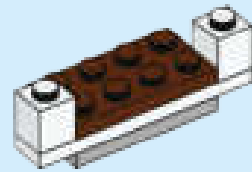

26

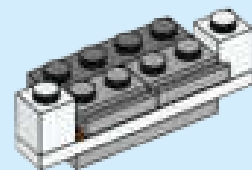

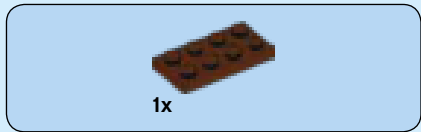

27

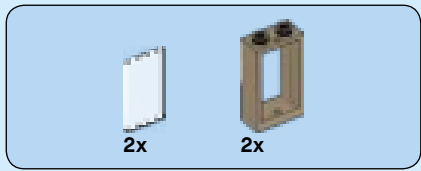
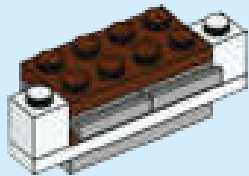

28

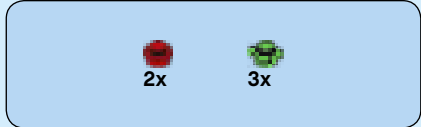
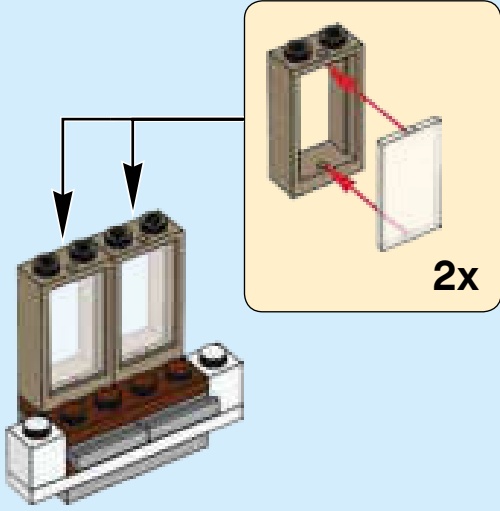

29

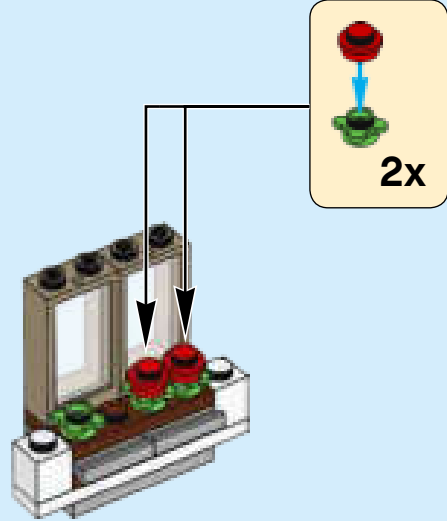

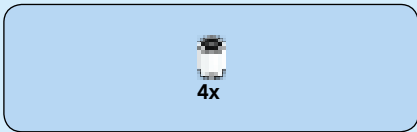

30

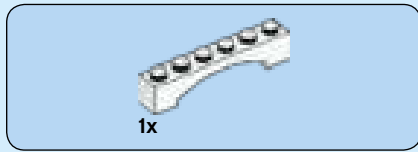
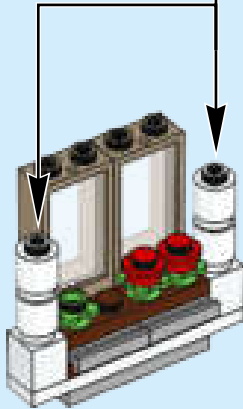

31

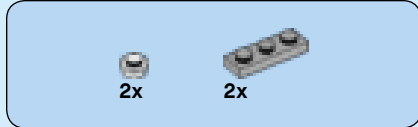
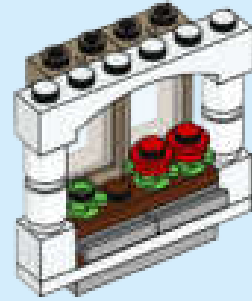

32

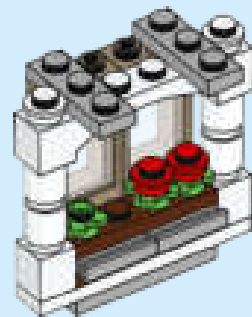

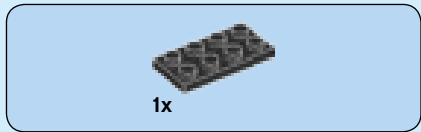

33

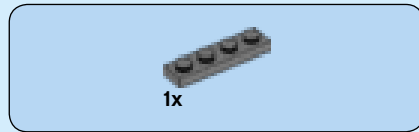
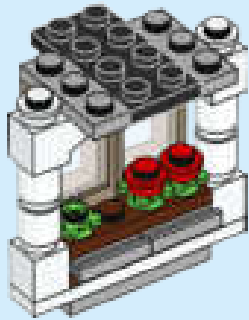

34

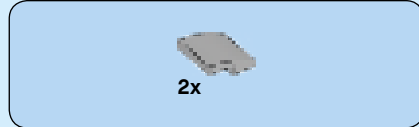
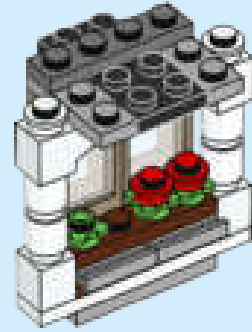

35

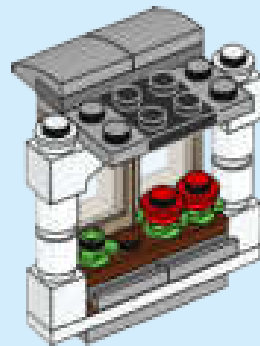

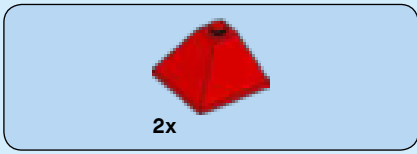

36

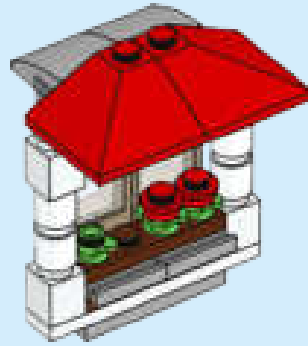

37

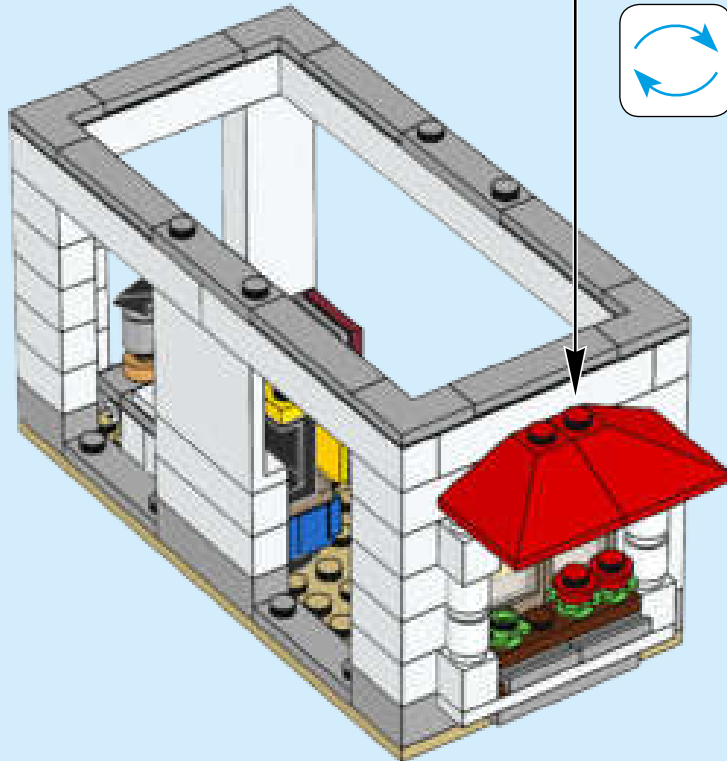

38

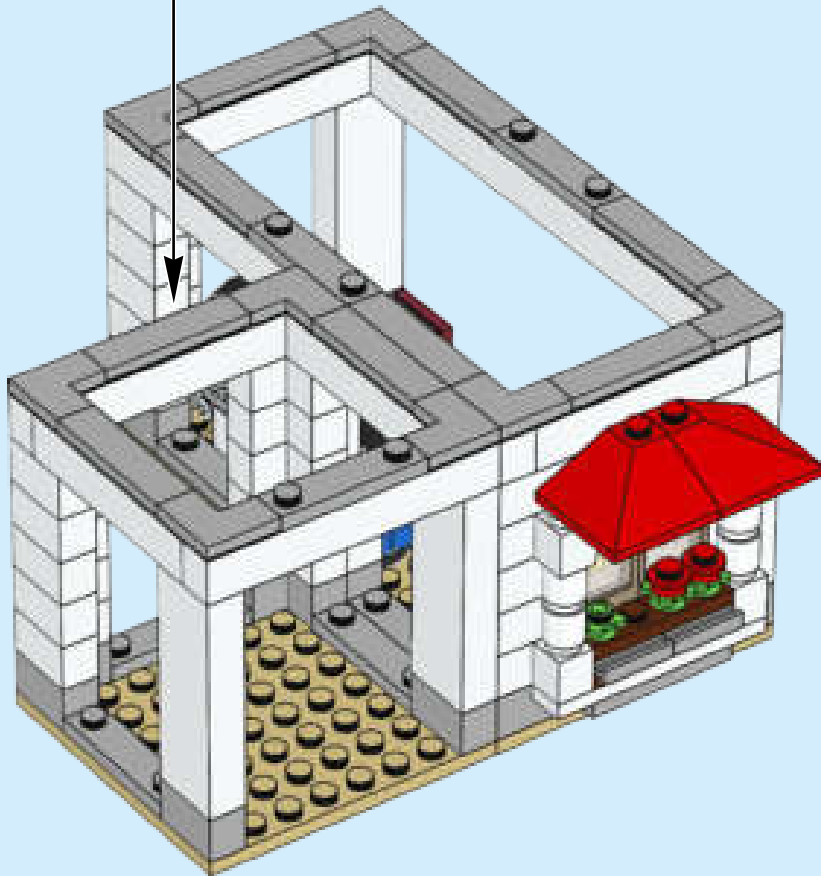
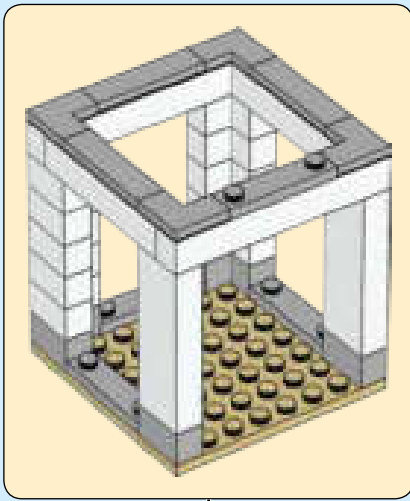



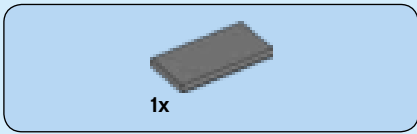

39

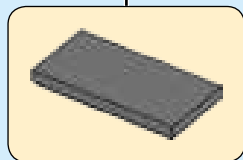
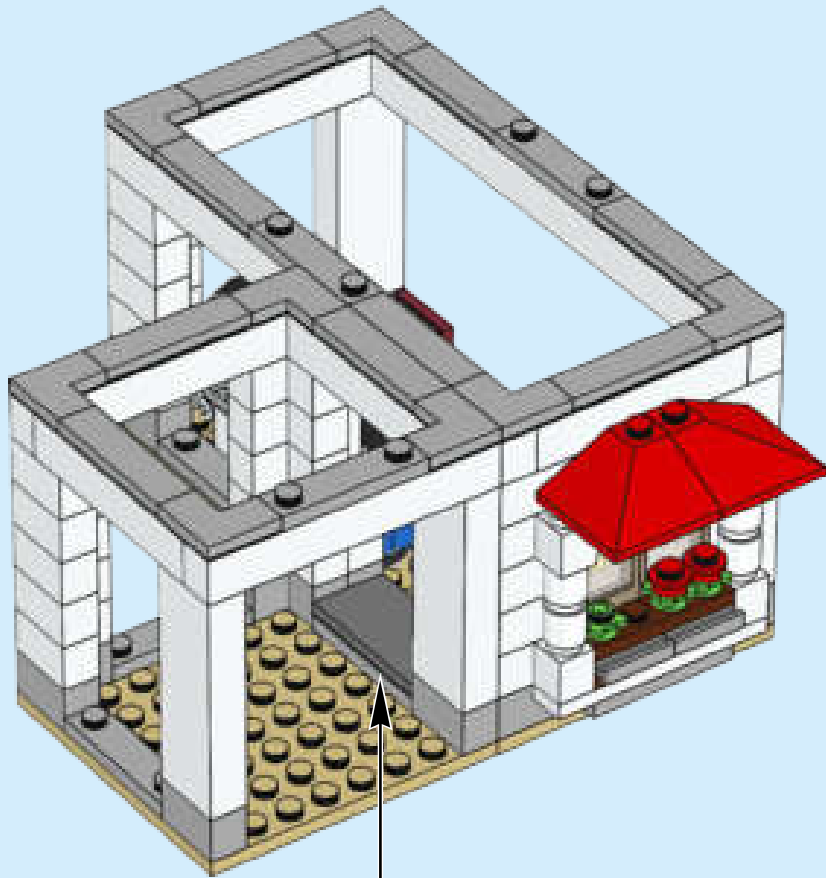

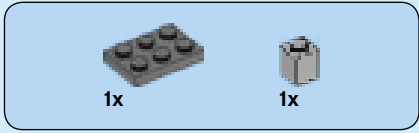

40

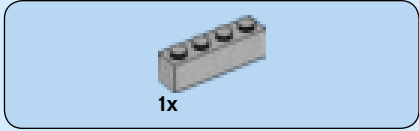
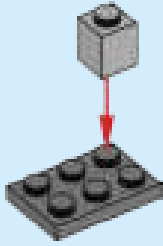

41

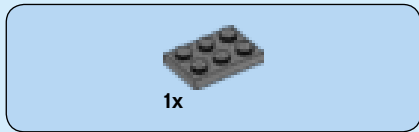
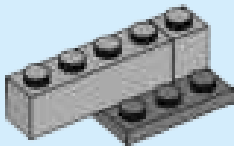

42

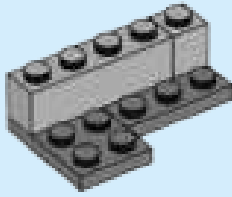

43

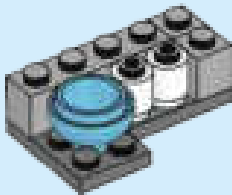

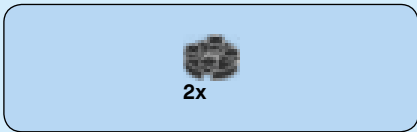

44

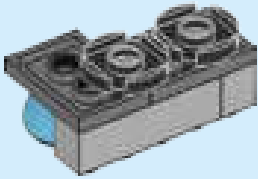
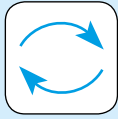

45

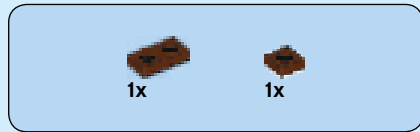
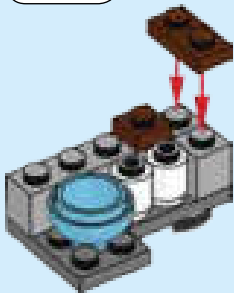
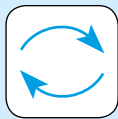

46

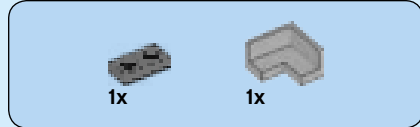

47

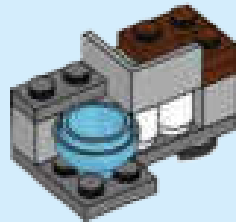

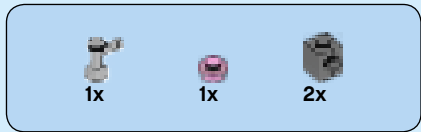

48

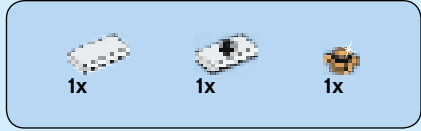
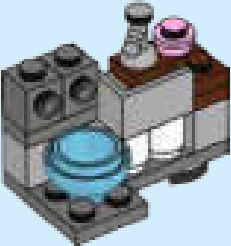

49

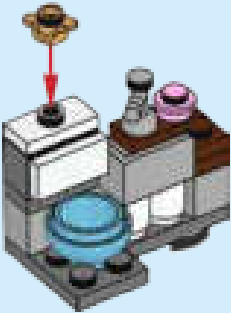

50

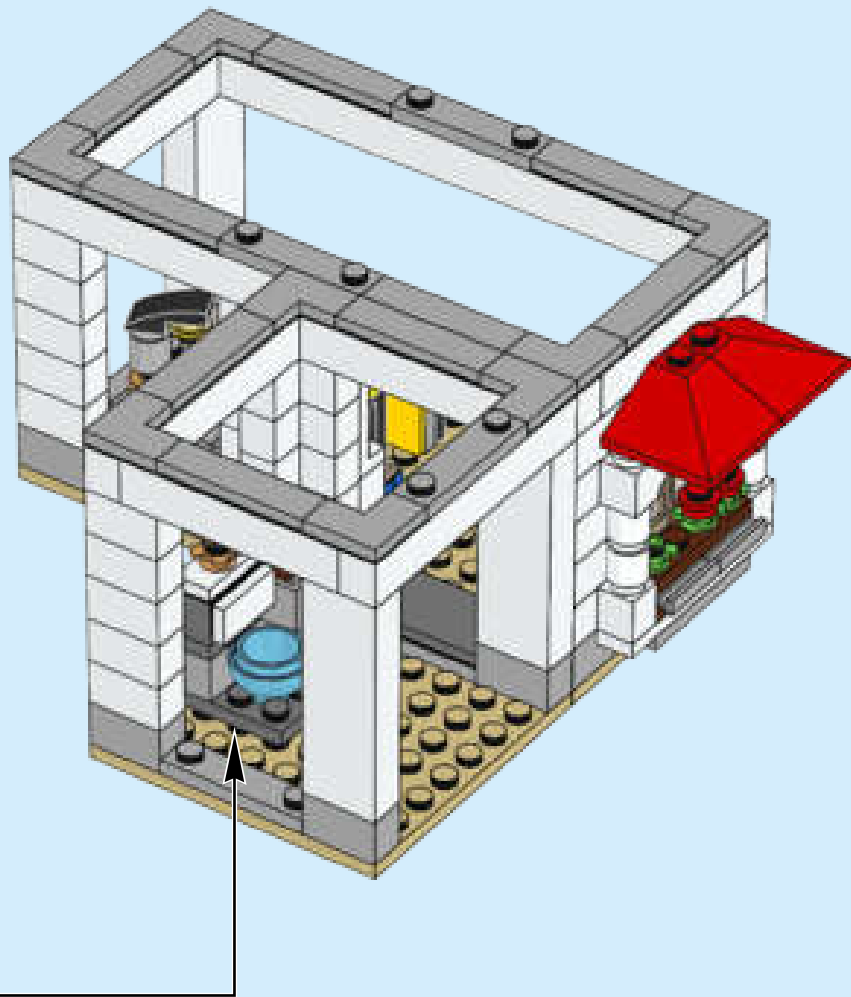

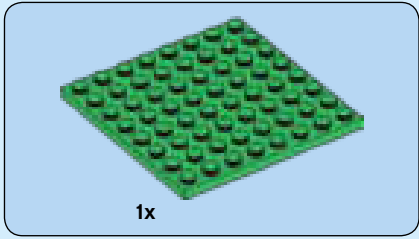
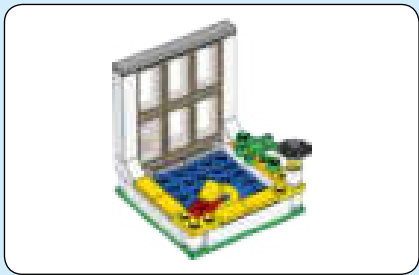

1x

51

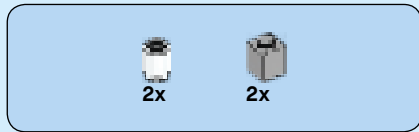
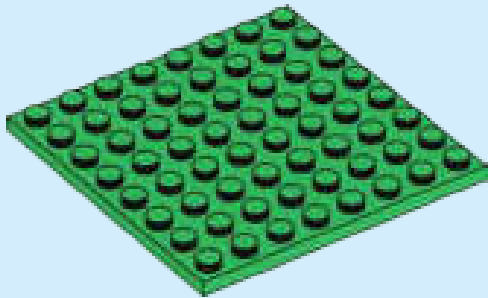

52

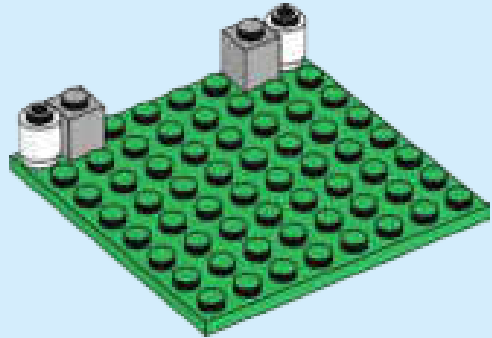

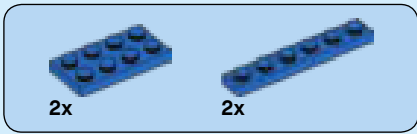

**53**

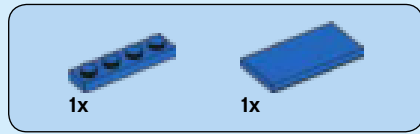
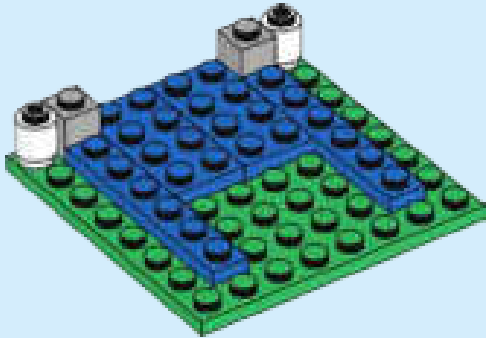

**54**

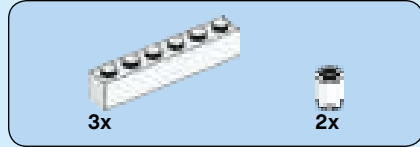
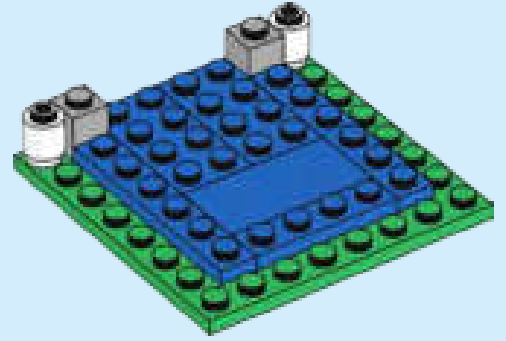

**55**

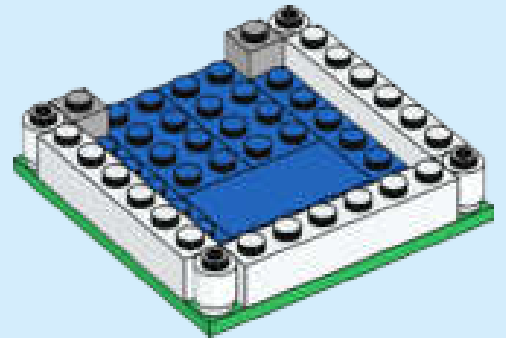

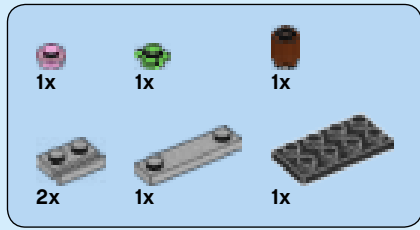

56

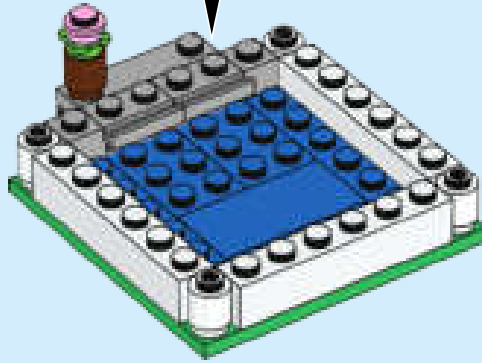
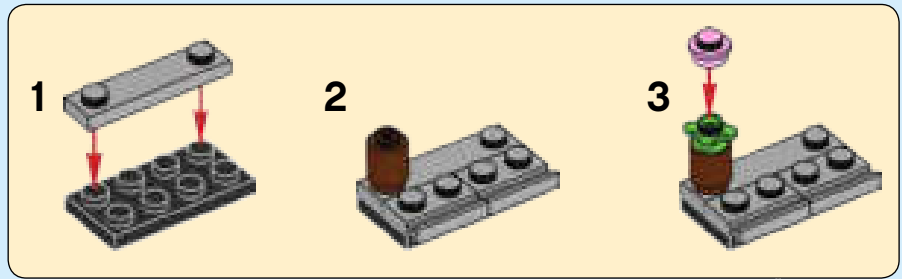

57

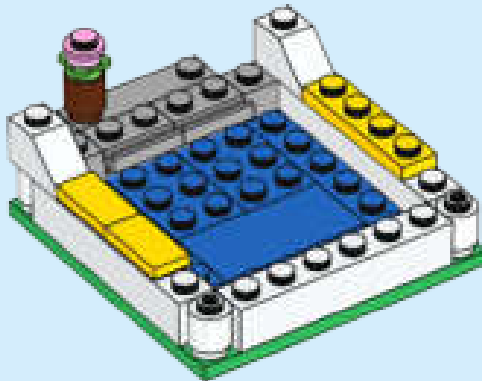



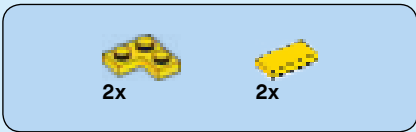

58

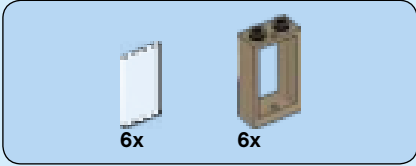
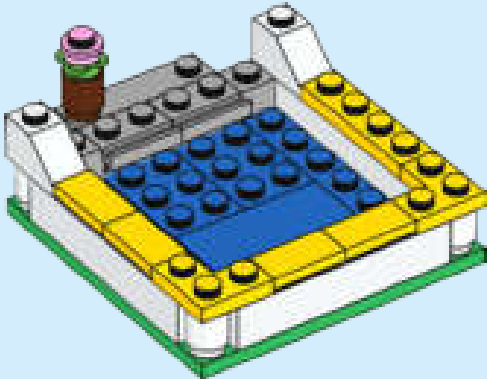

59

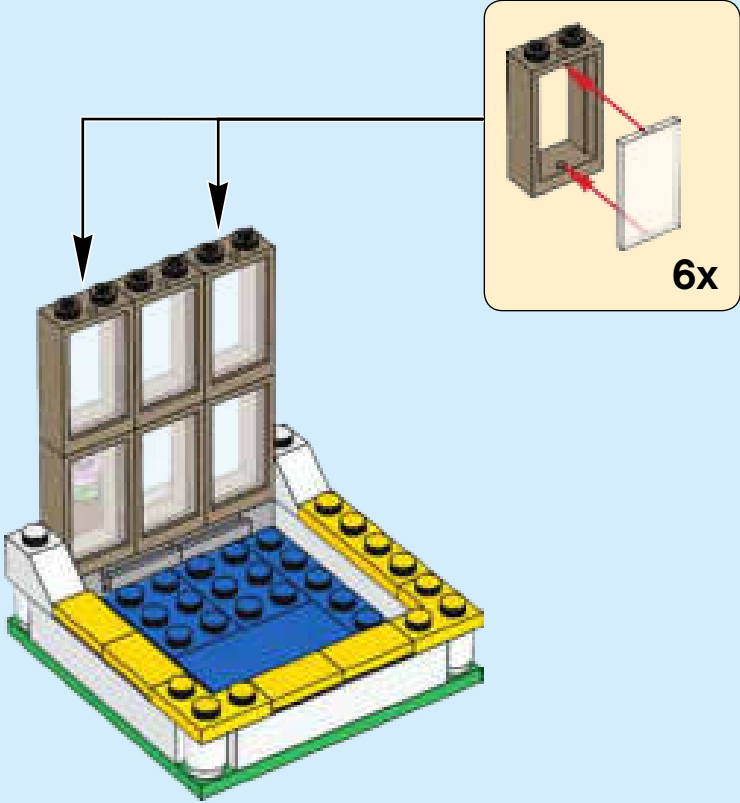

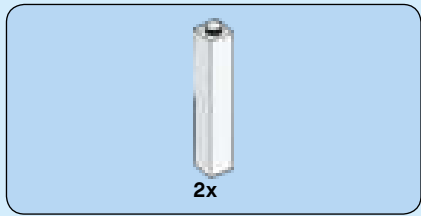

60

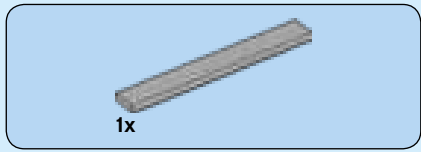
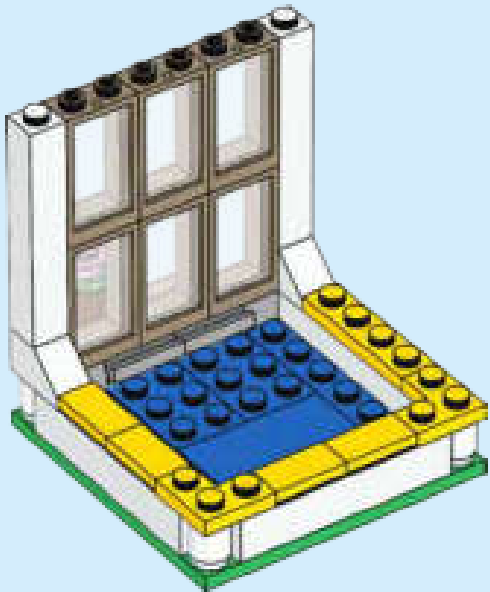

61

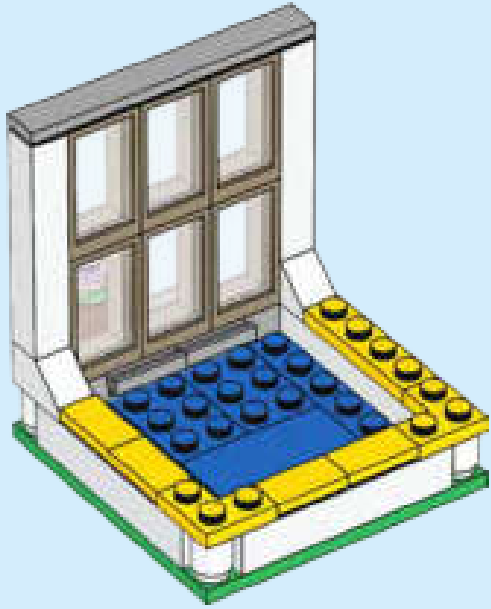

62

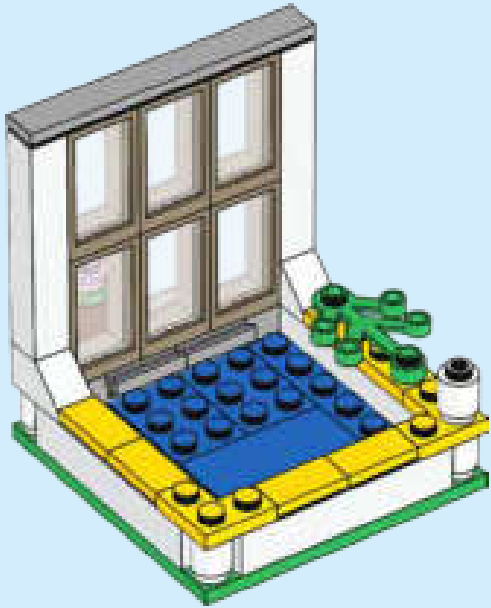



63

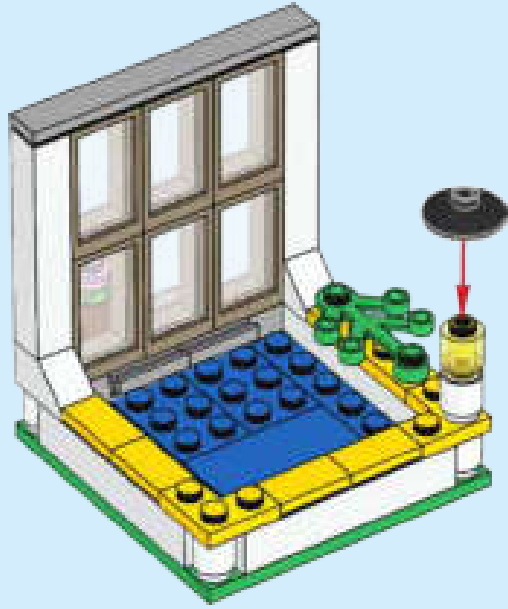

64

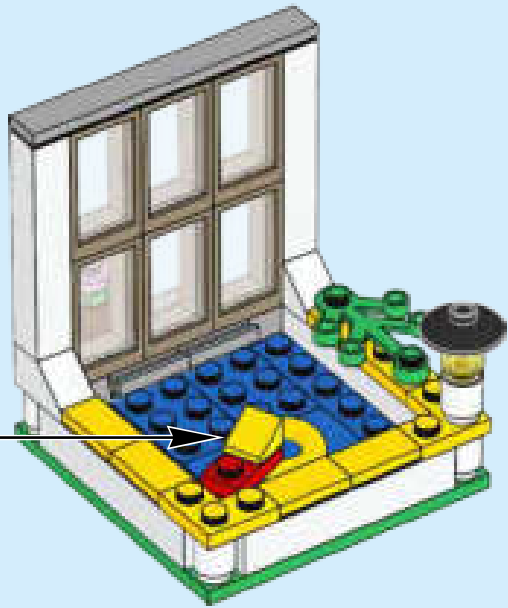
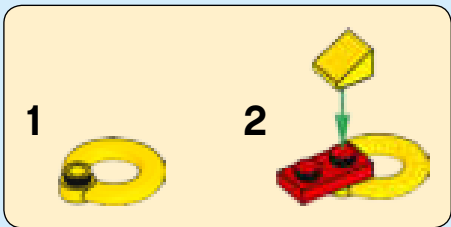

65

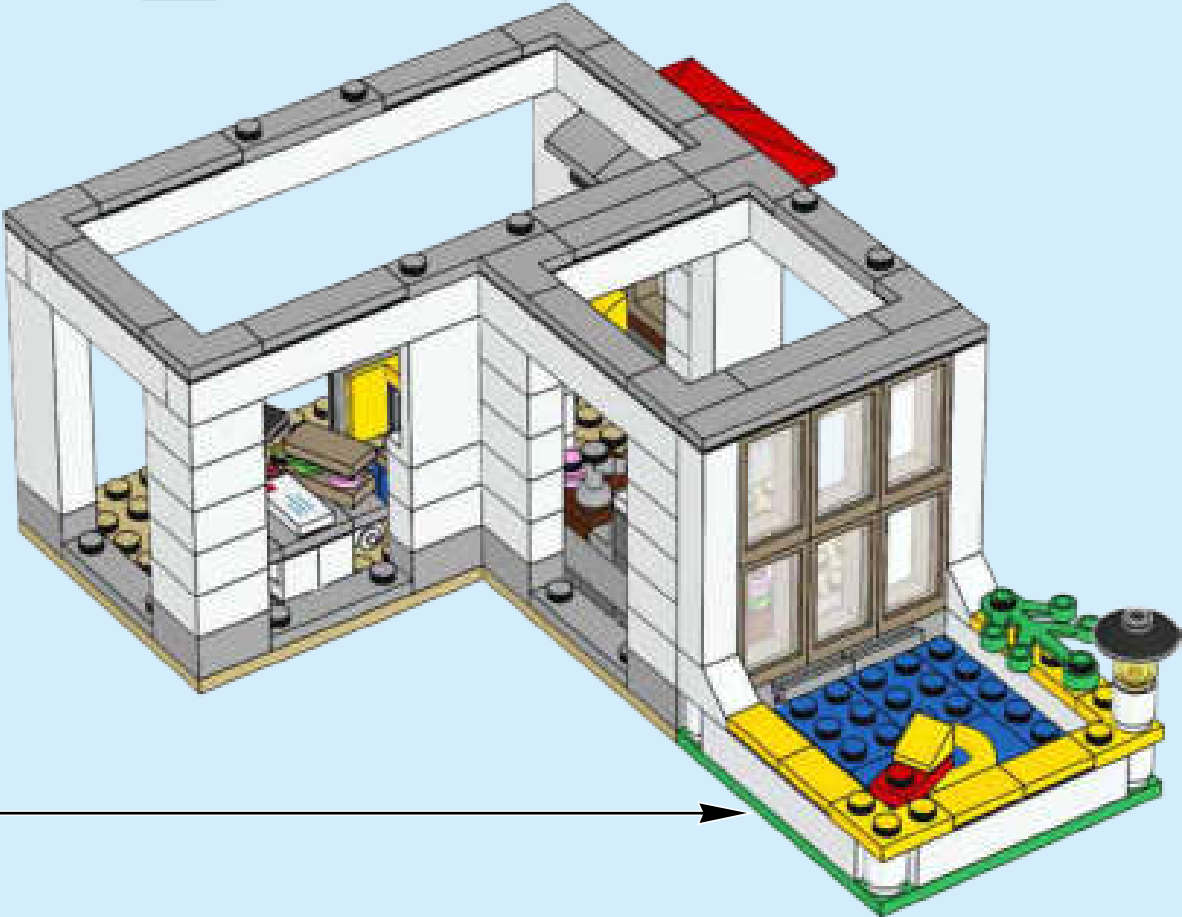
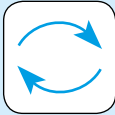

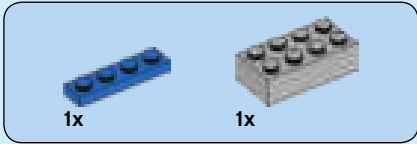

66

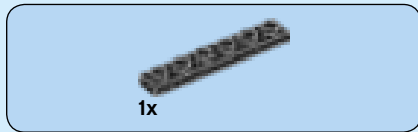
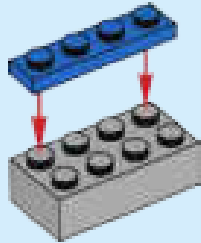

67



68



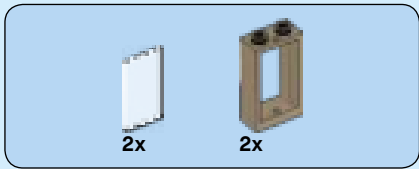

69

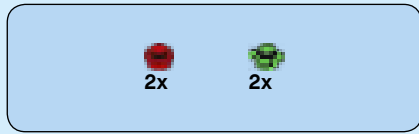
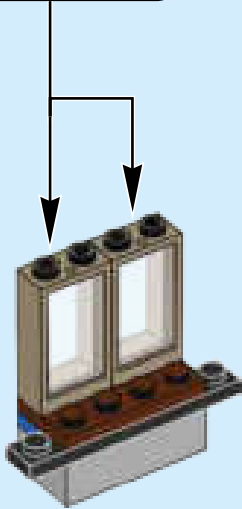
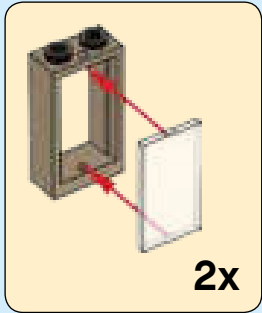

70

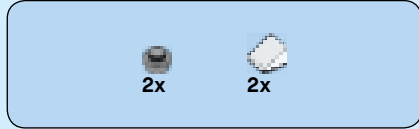
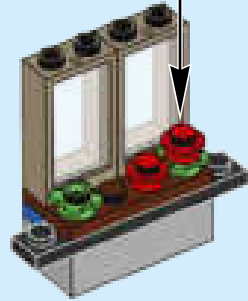
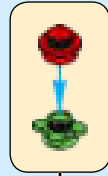

71

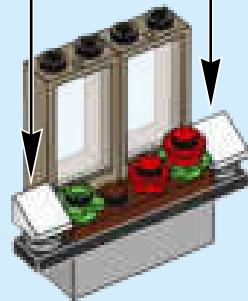
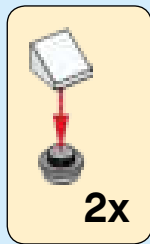

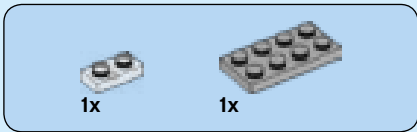

72

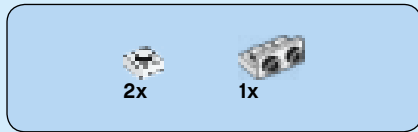
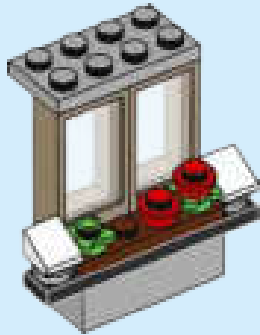
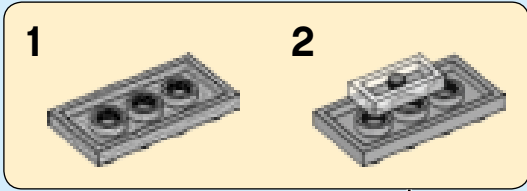

73

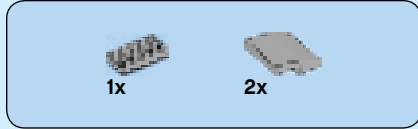
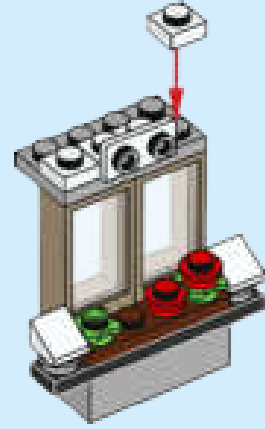

74

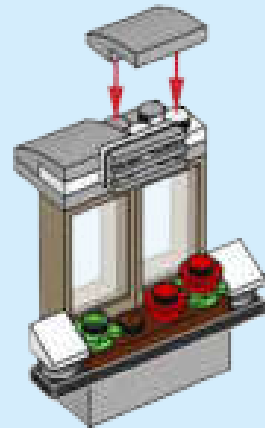

2x

75

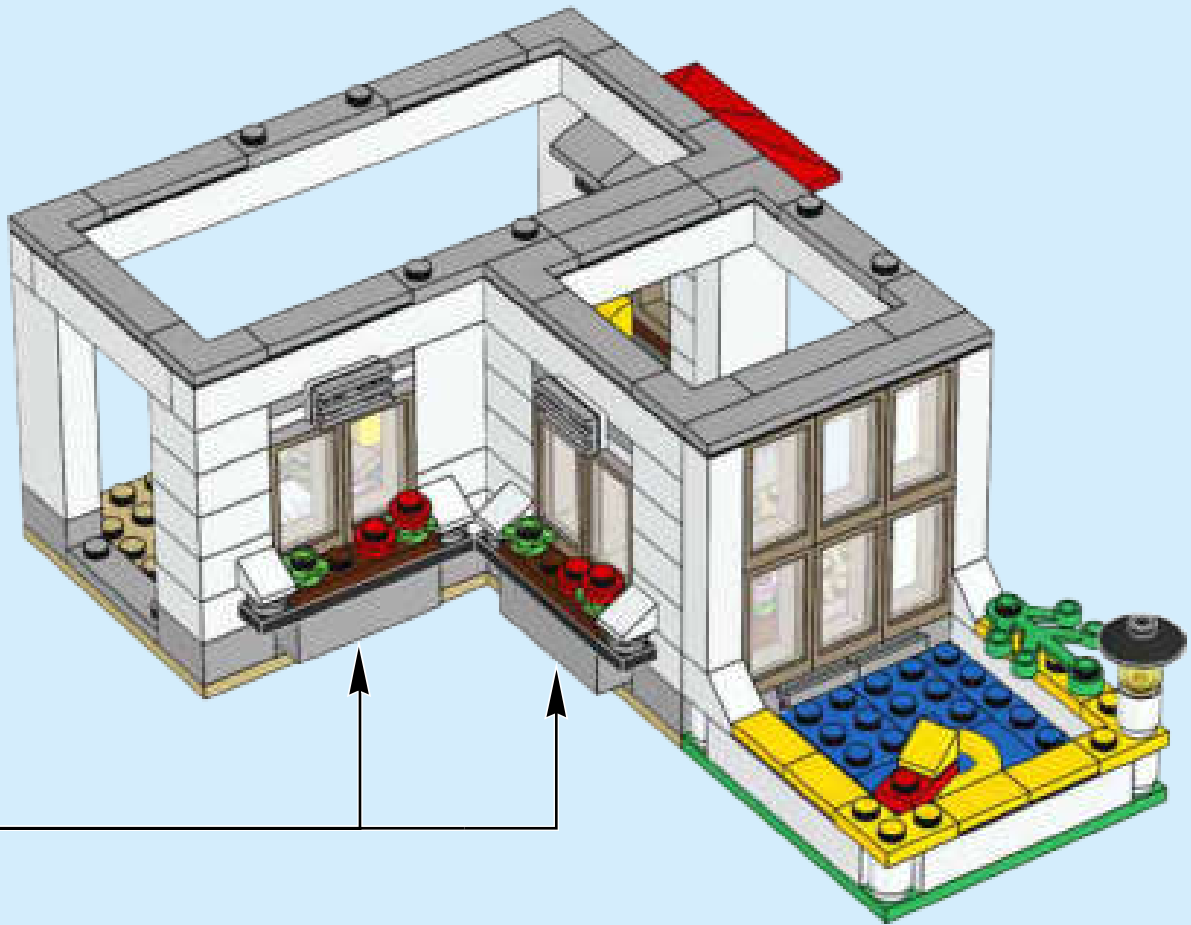



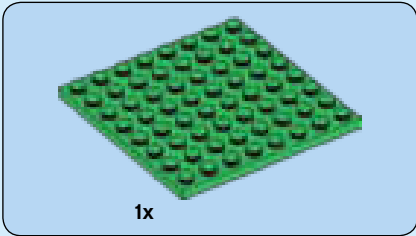
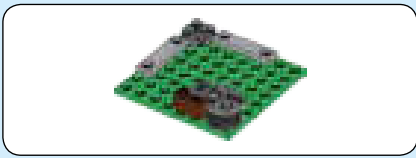

76

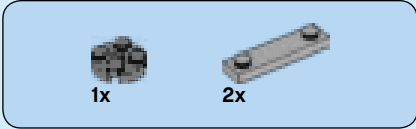
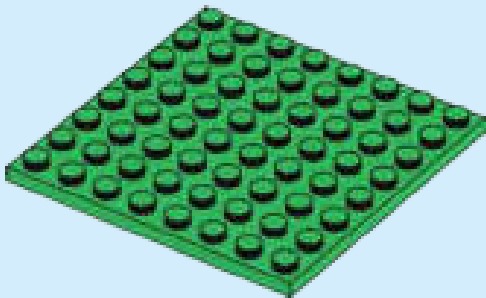

77

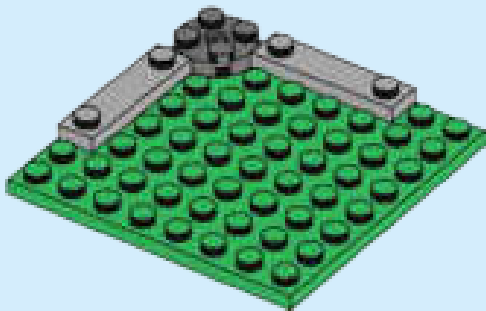

78

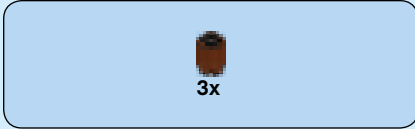
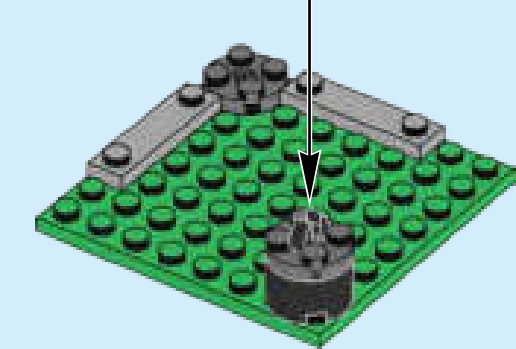
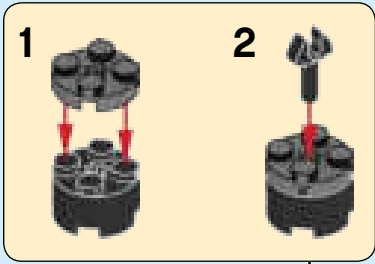

79

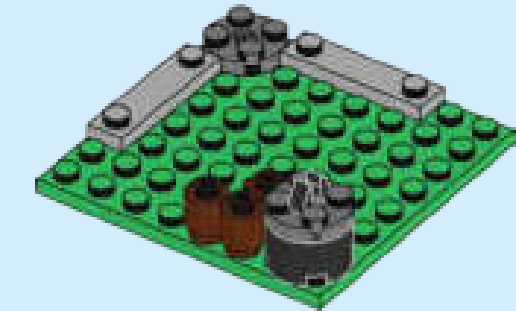



1x

80



81

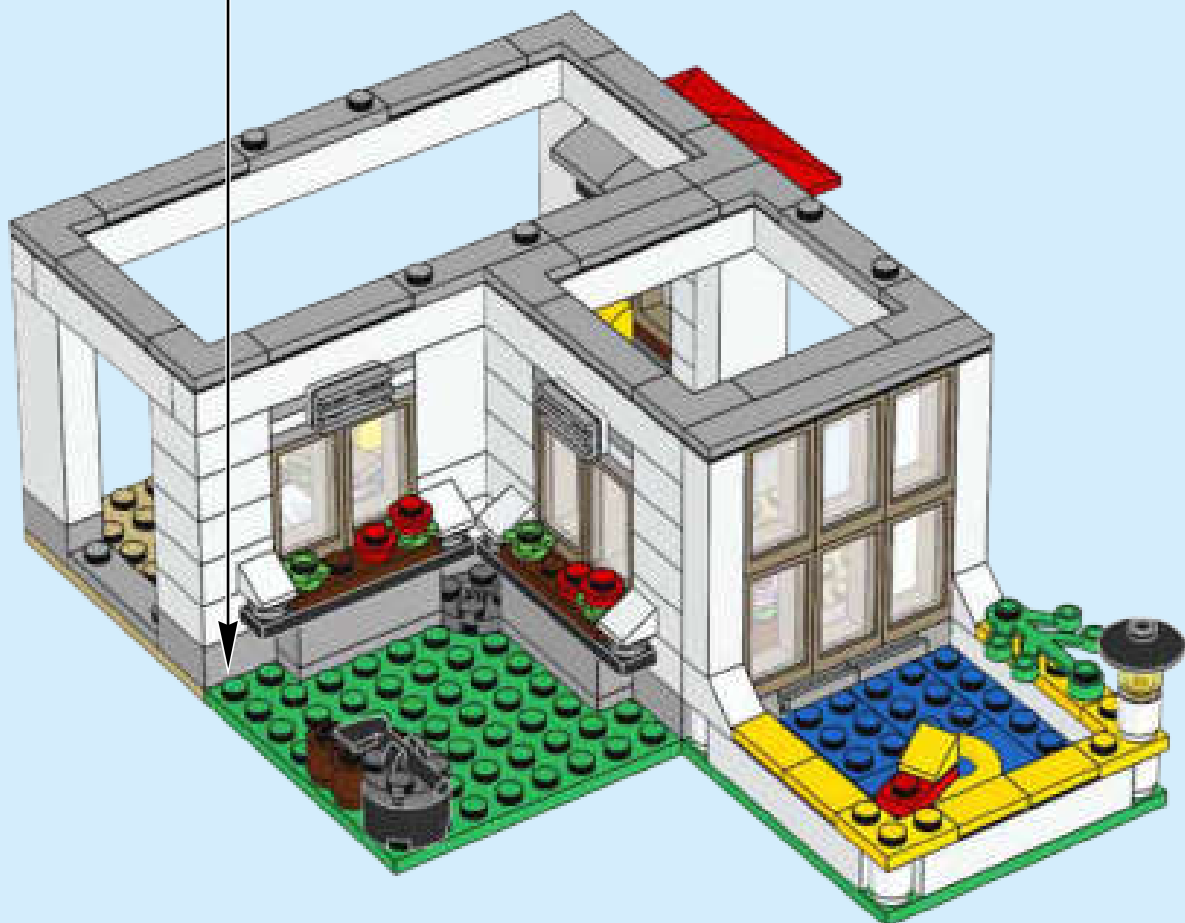

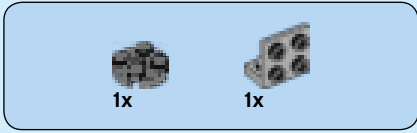

82



83

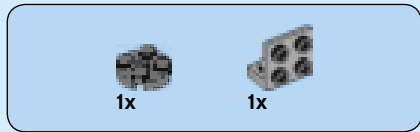

84

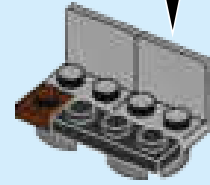
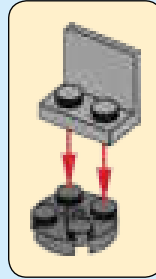

85

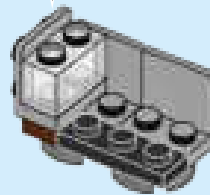
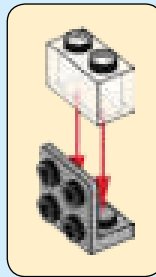

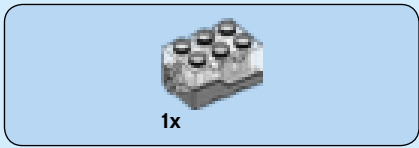

86

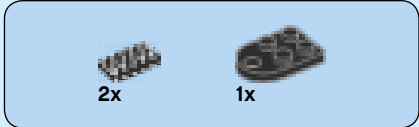
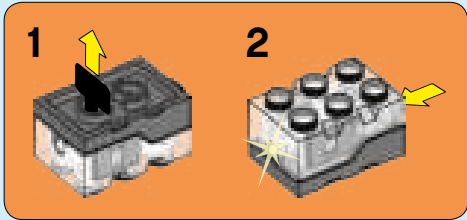

87

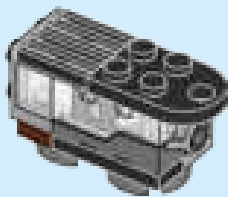

88

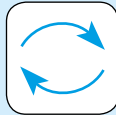

89

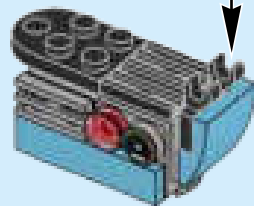

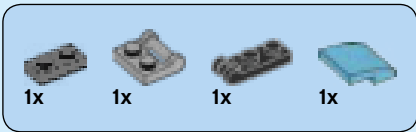

# 90

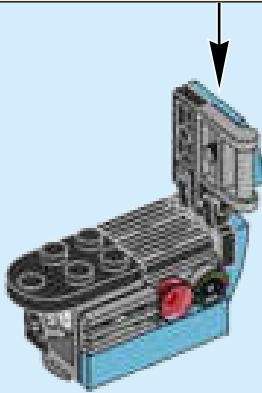
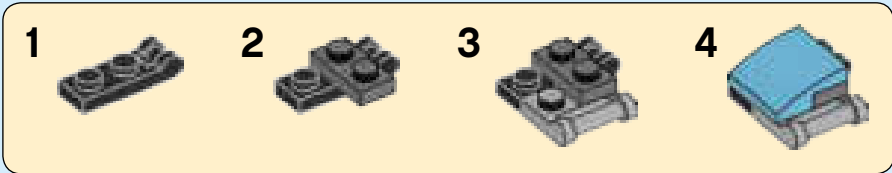

# 91

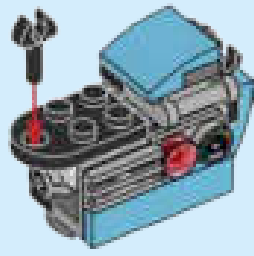

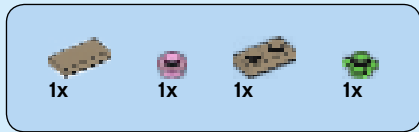

# 92

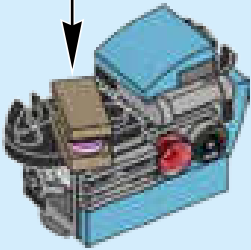

# 93

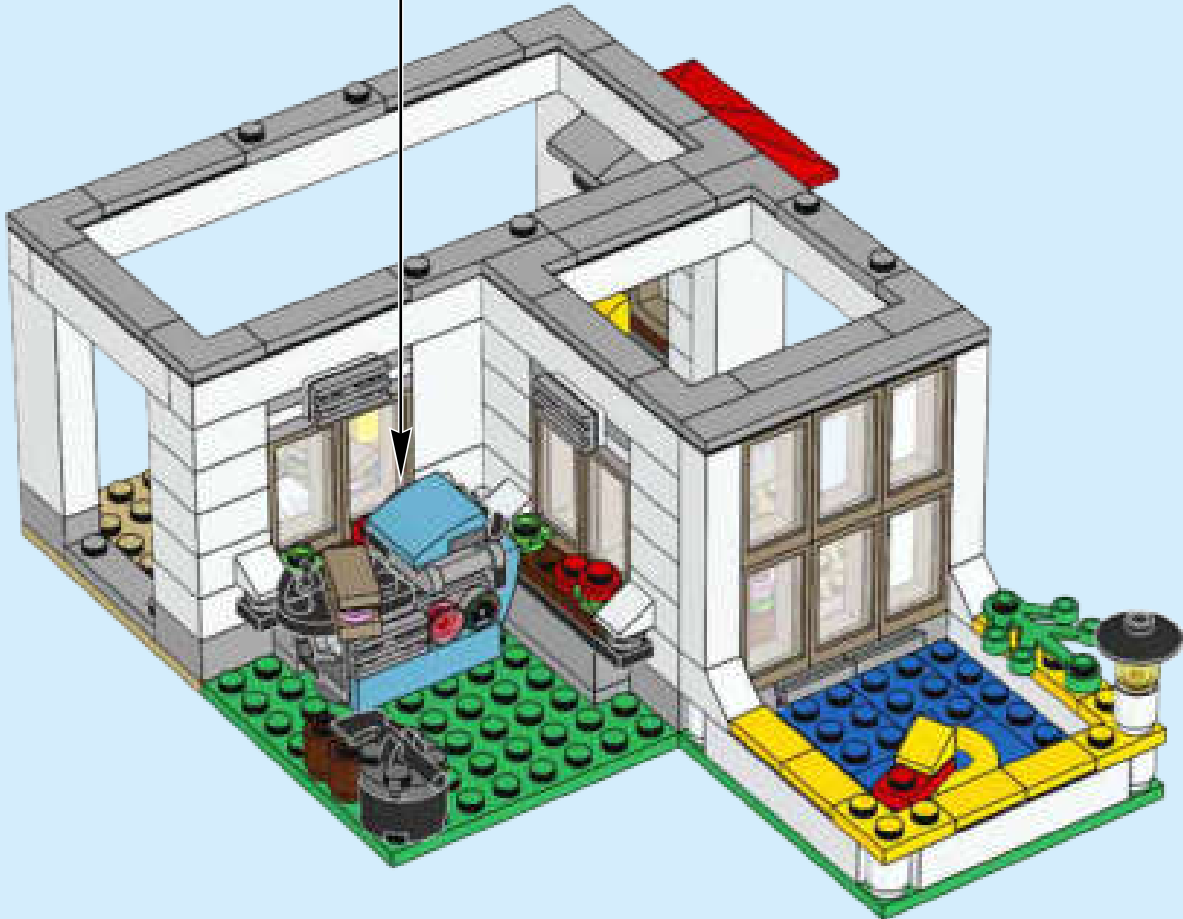

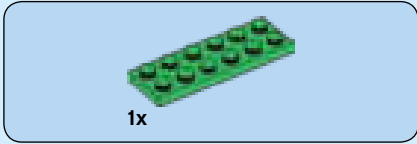

94

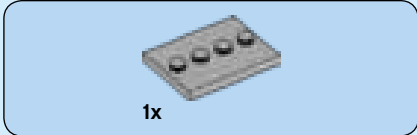

95

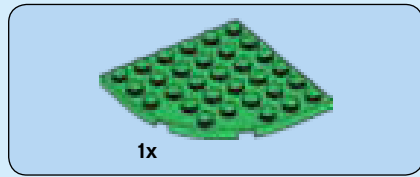
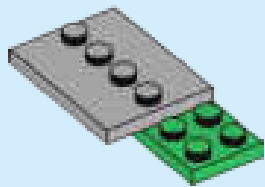

96

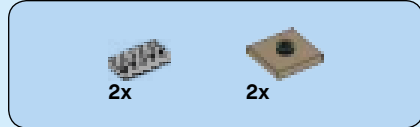
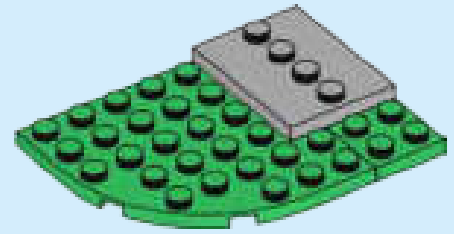

97

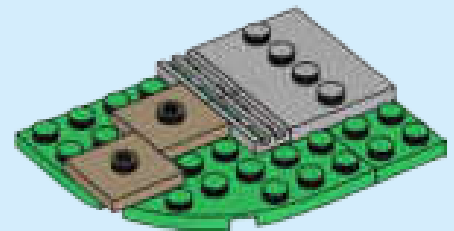

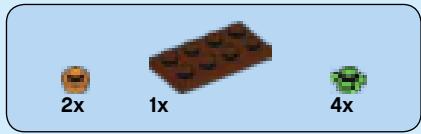

98

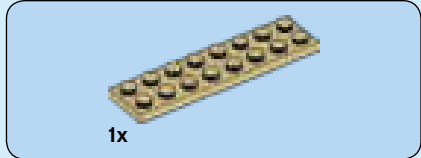
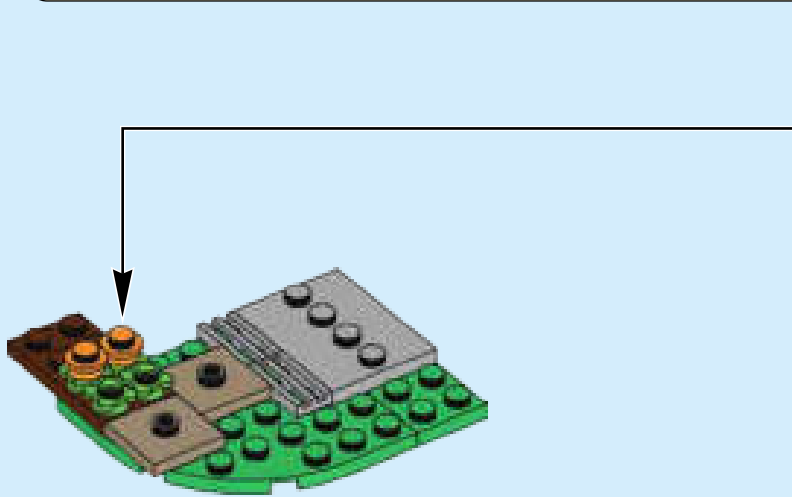

99

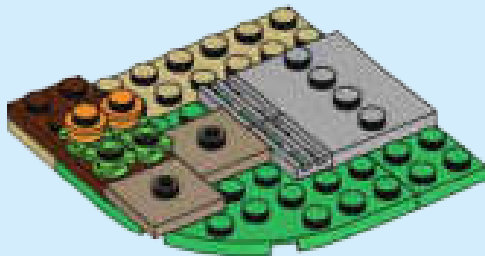



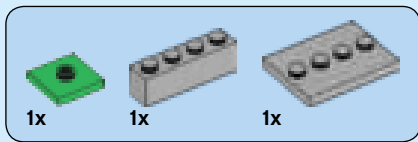

100

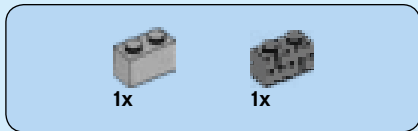
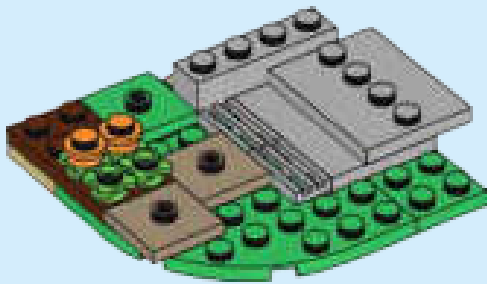

101

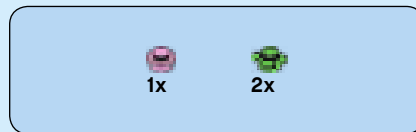
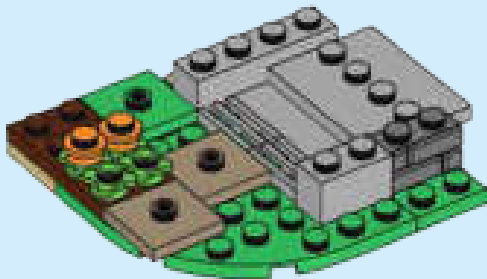

102

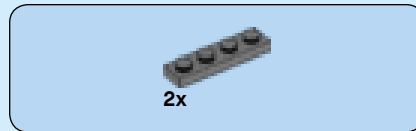
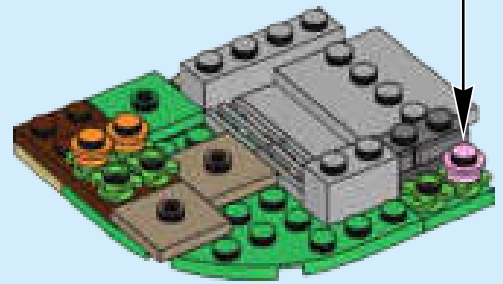

103

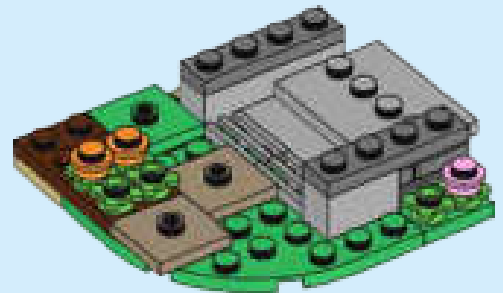

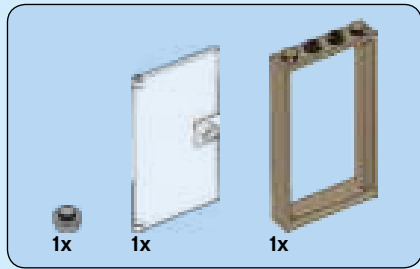

104

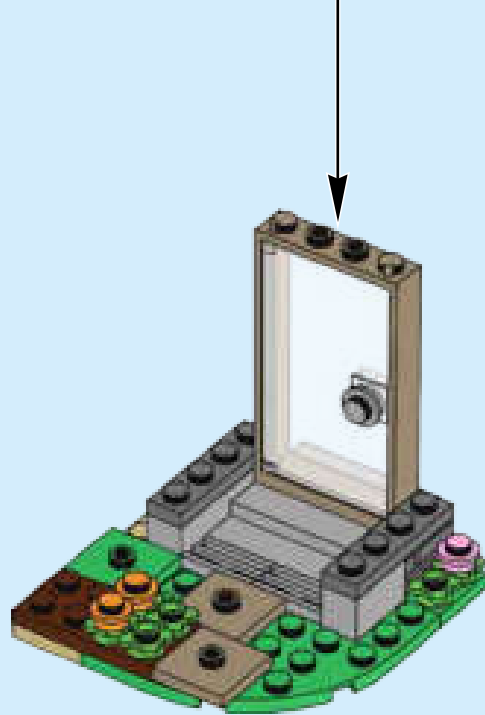
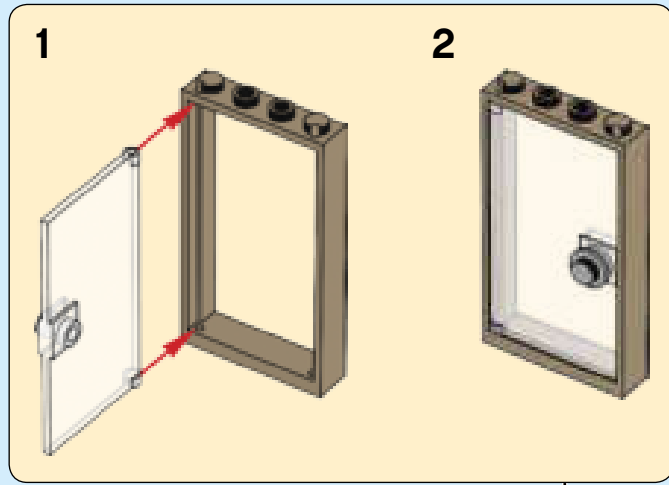

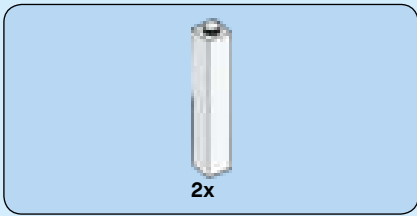

105

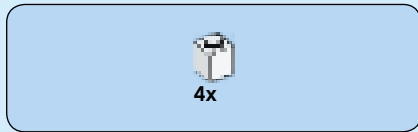
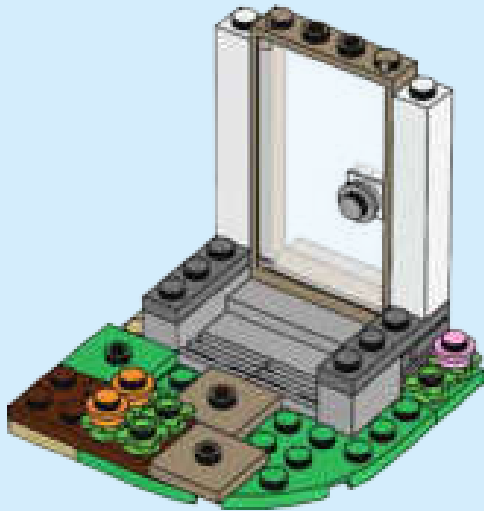

106

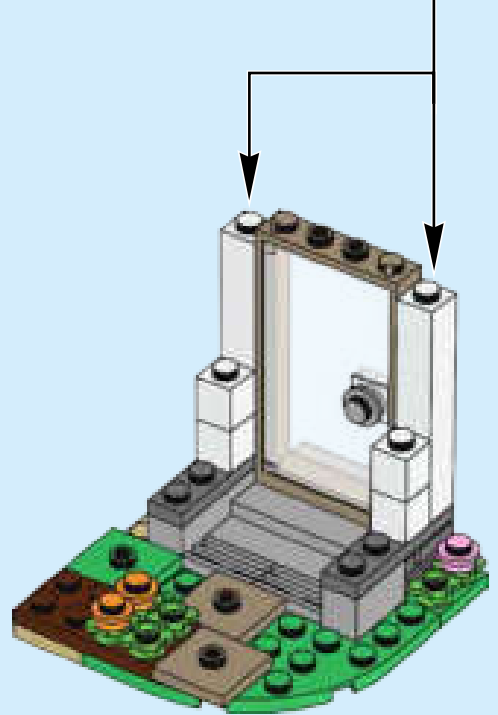
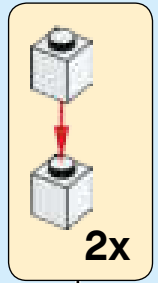



6x

# 107

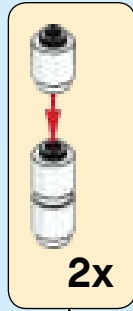

2x

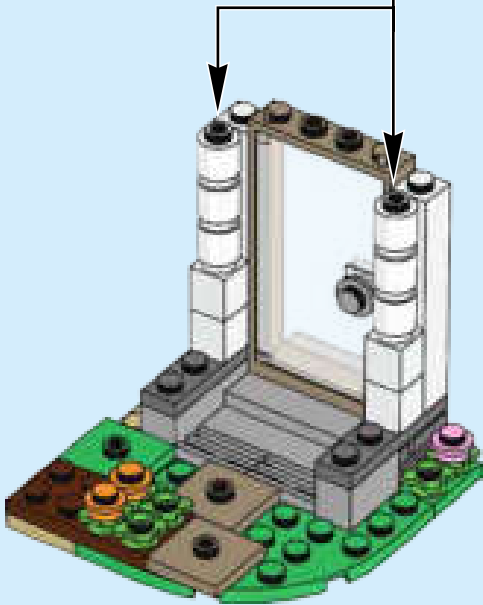

4x



2x

# 108

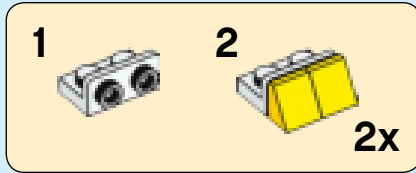

1

2

2x

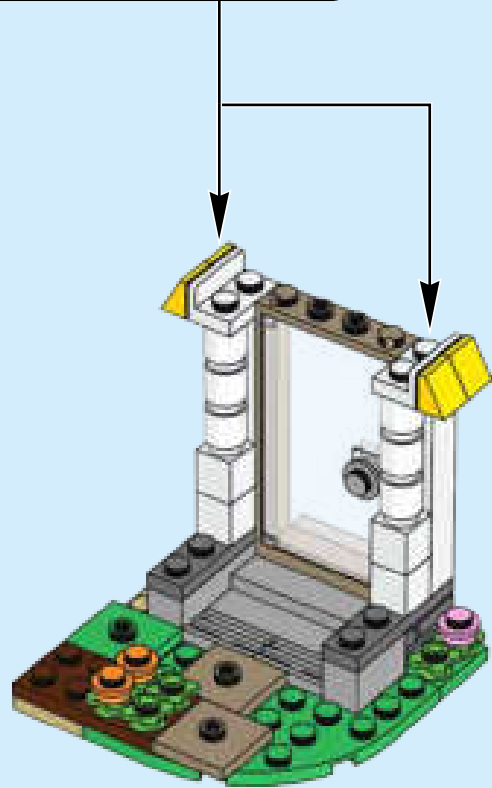

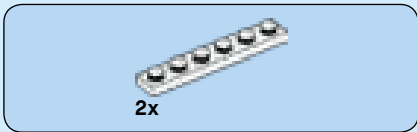

109

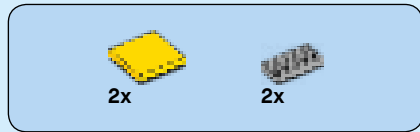

110

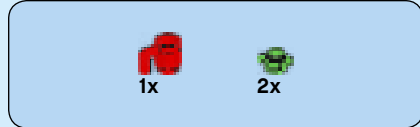
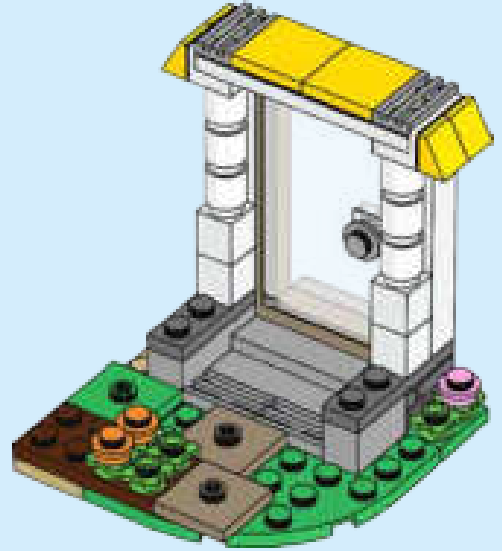

111





112

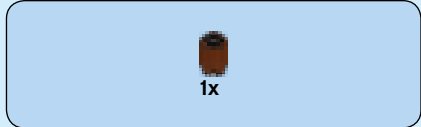

113

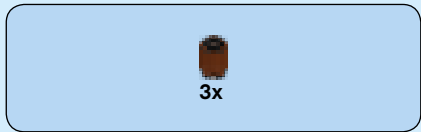

114

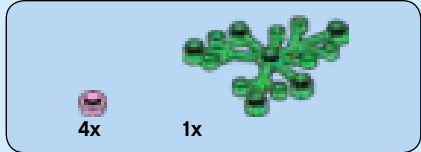

115

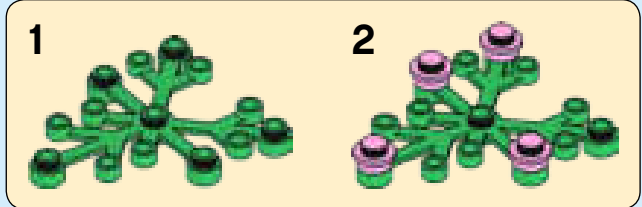

116

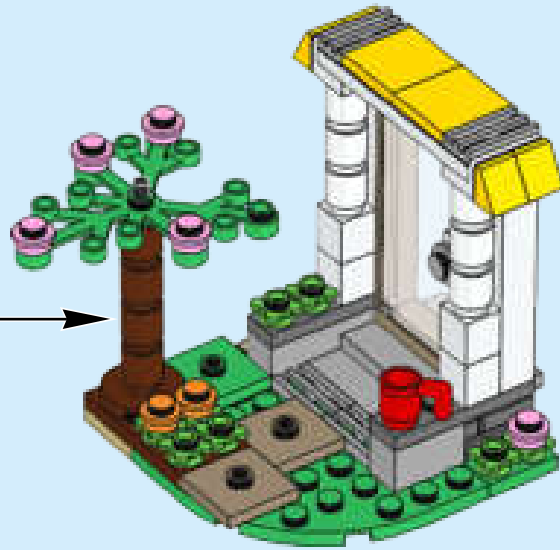

117



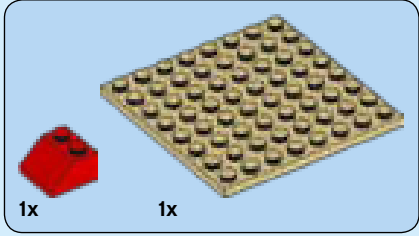

118

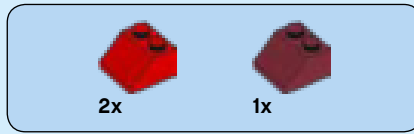
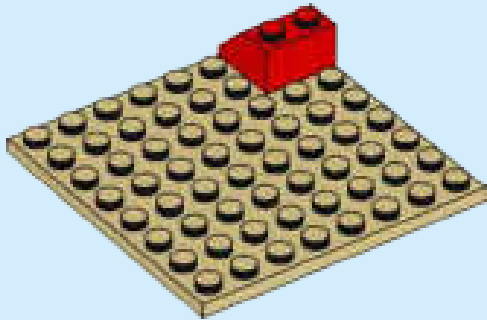

119

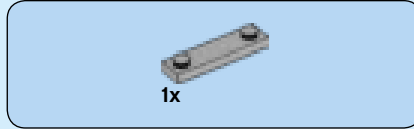
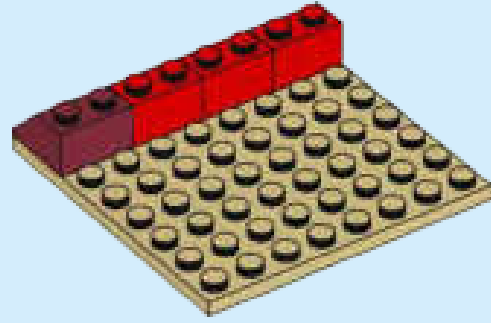

120

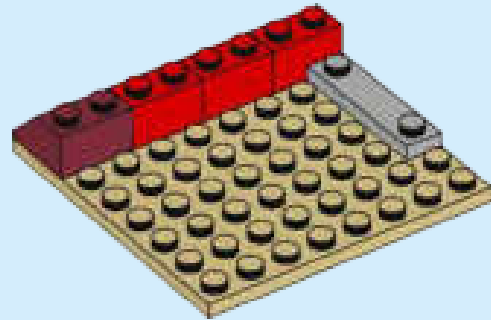



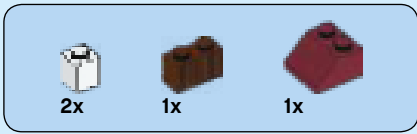

121

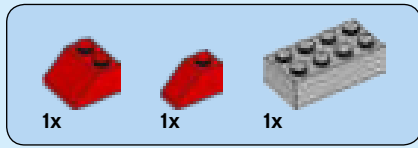
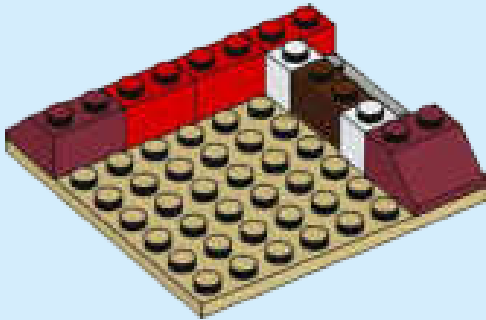

122

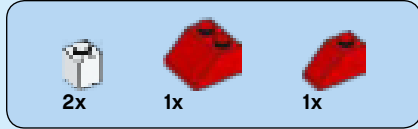
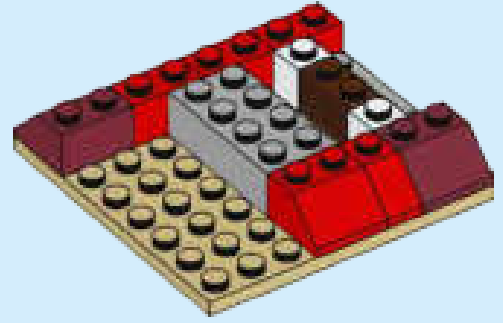

123

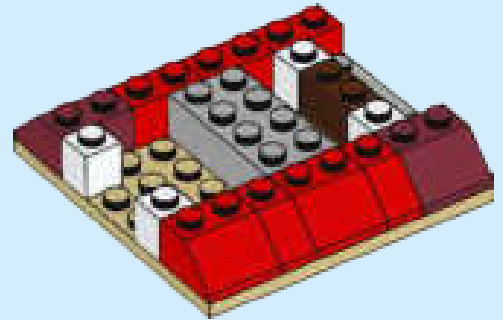

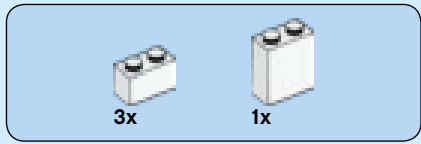

124

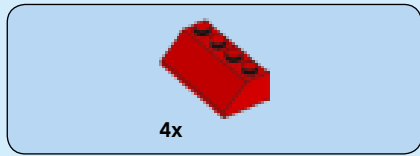
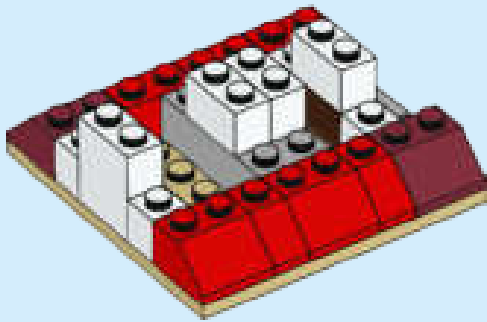

125

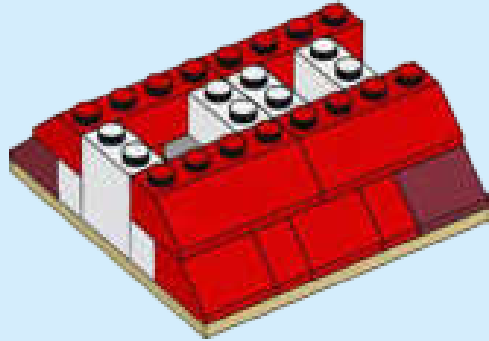

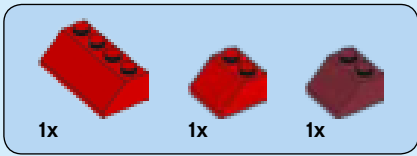

126

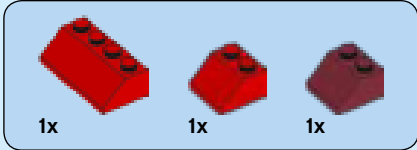
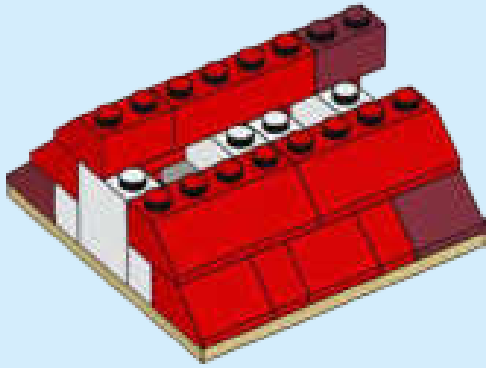

127

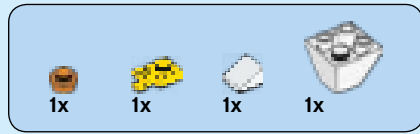
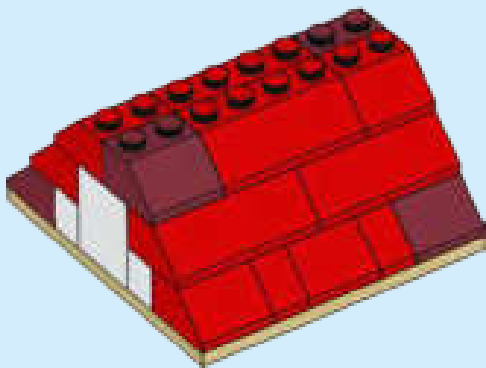

128

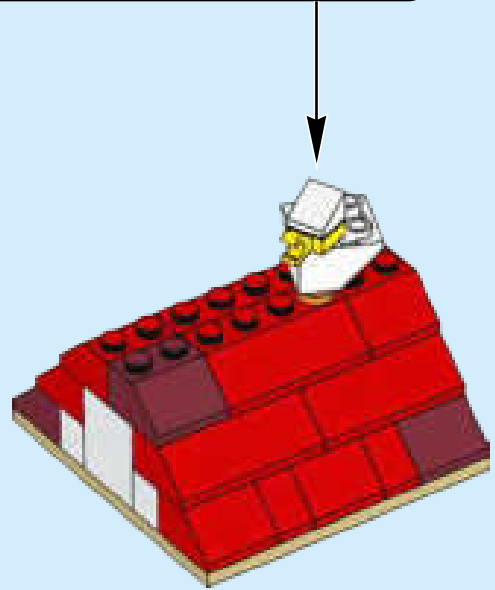
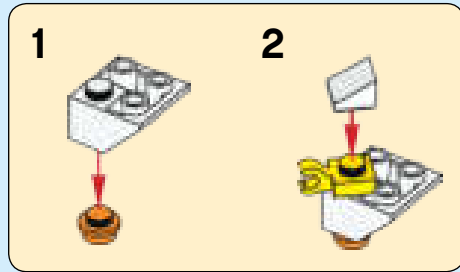

129

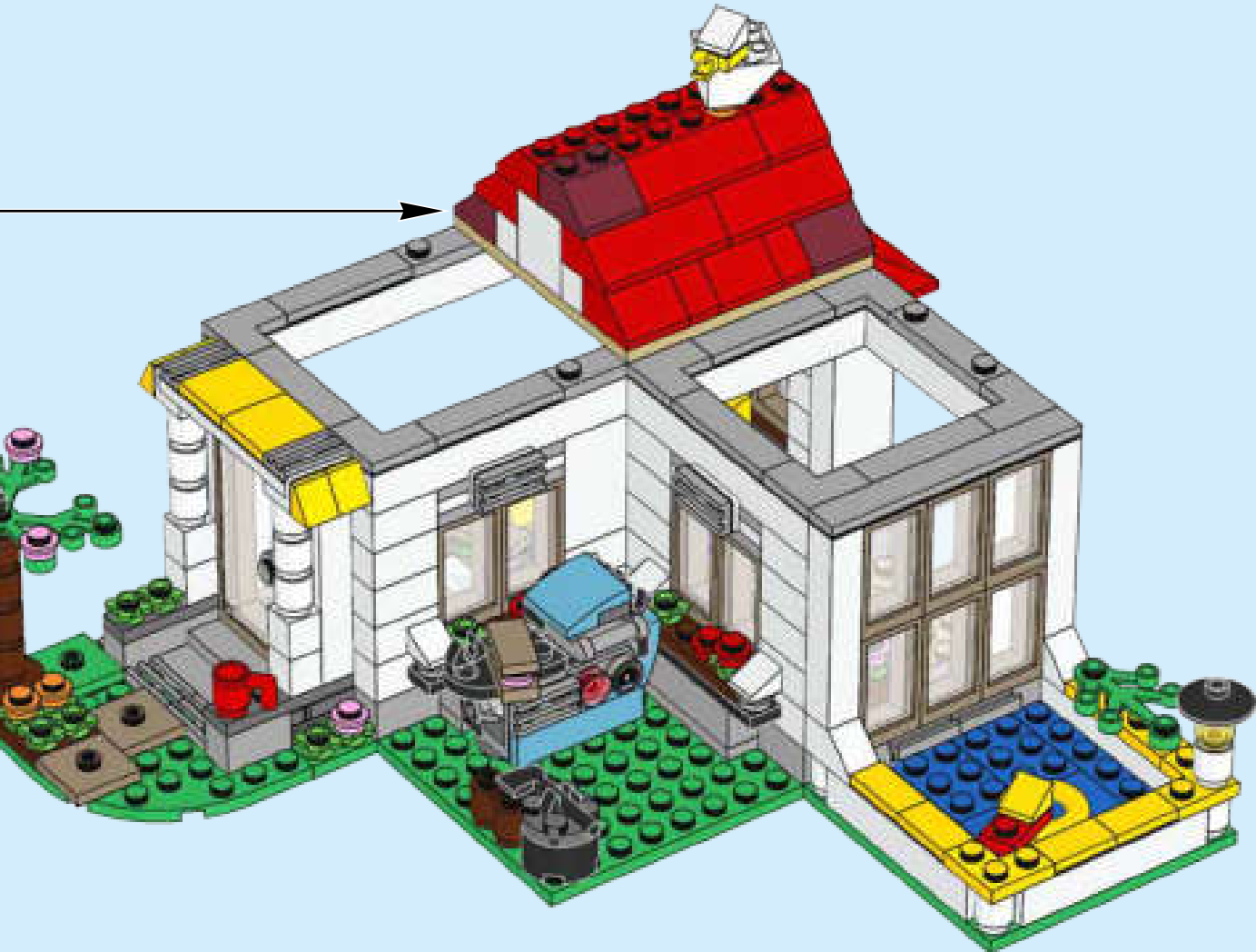

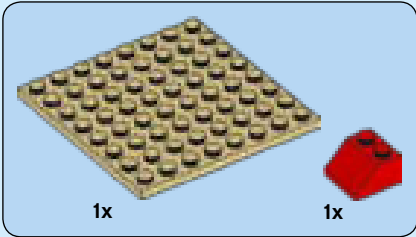

130

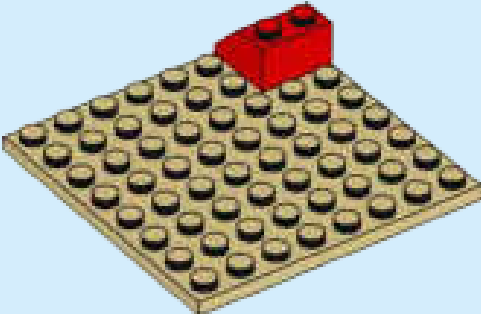

131

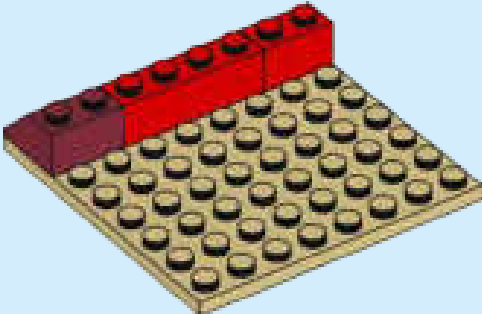

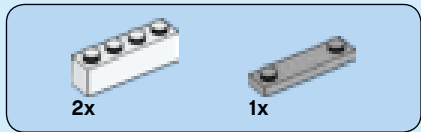

132

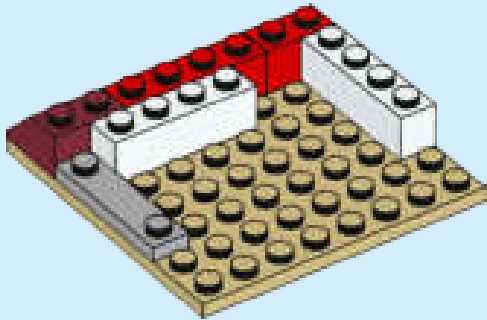

133

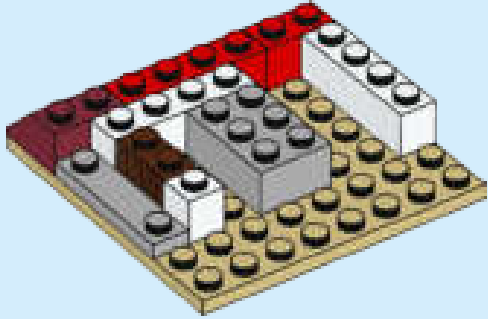

134

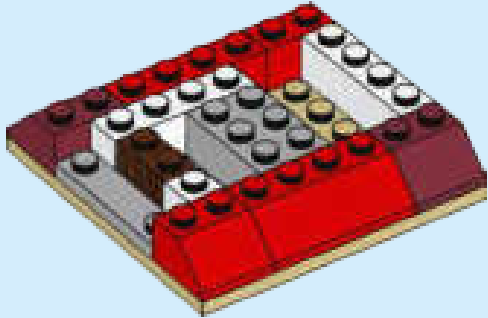

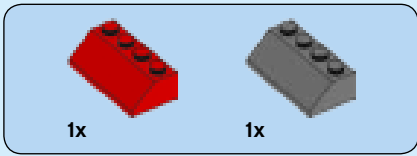

135

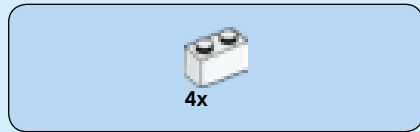
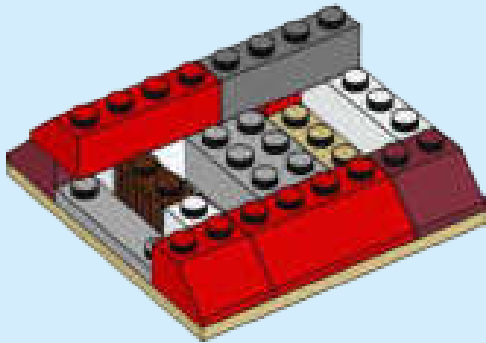

136

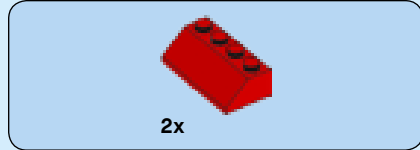
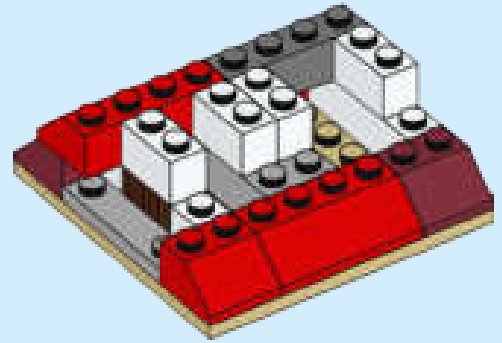

137

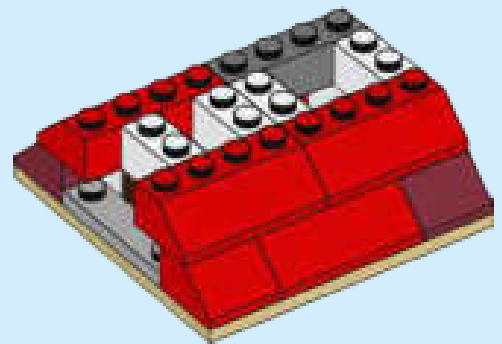

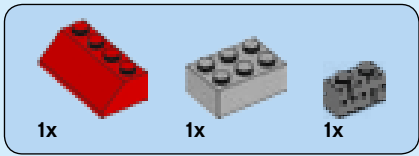

138

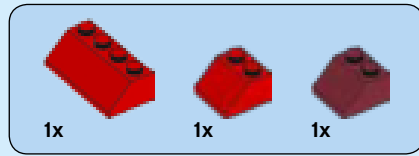
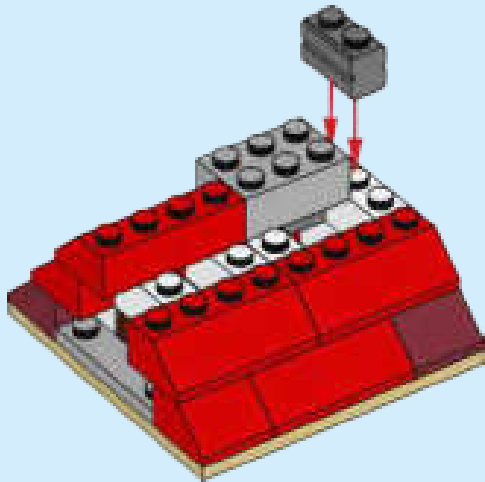

139

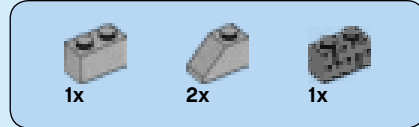
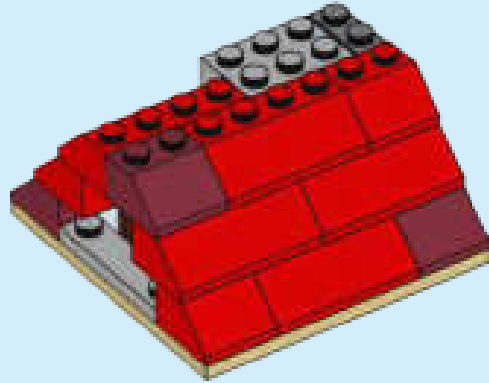

140

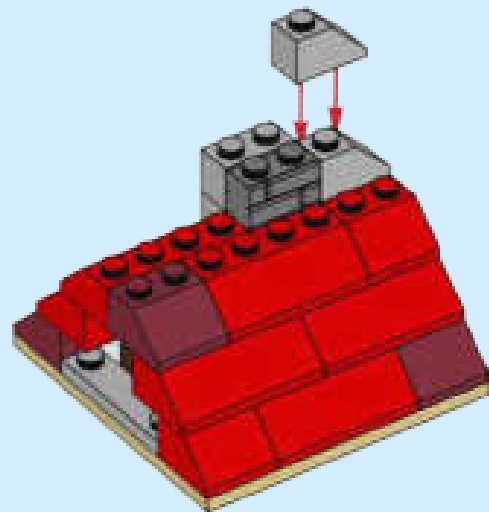



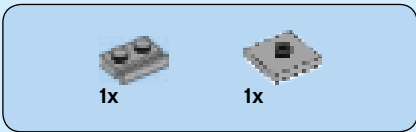

# 141

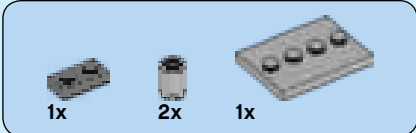
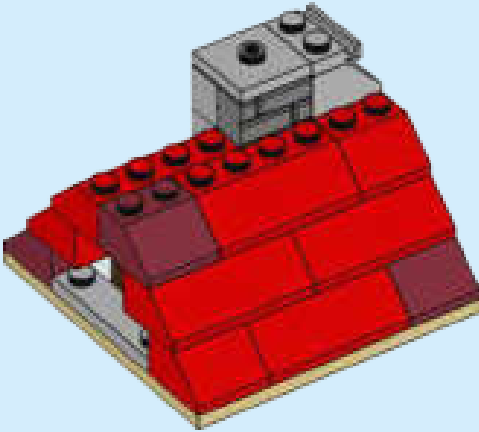

# 142

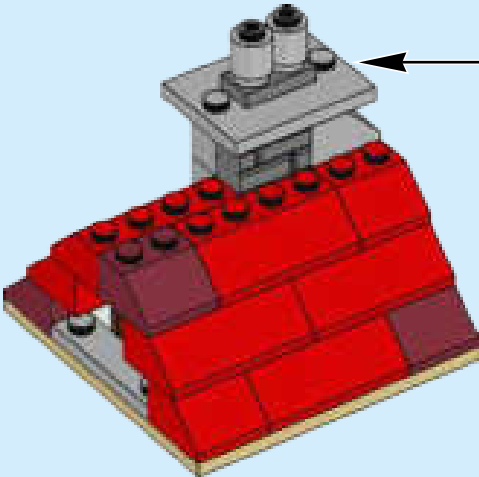
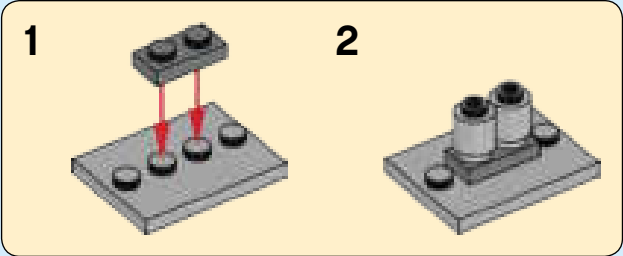

143

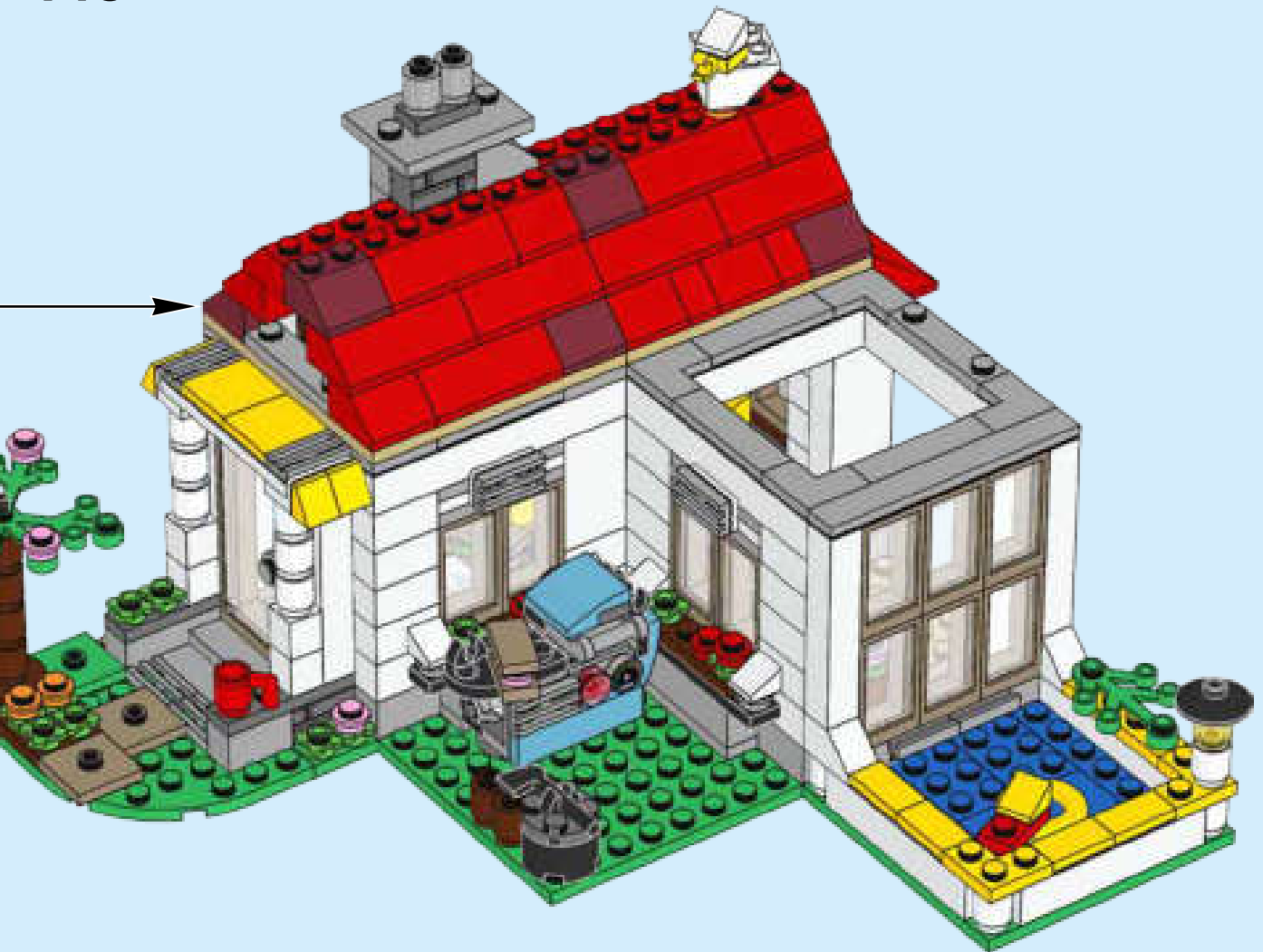

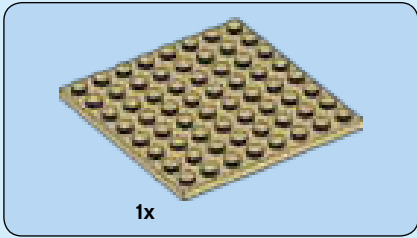

144

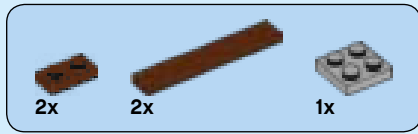
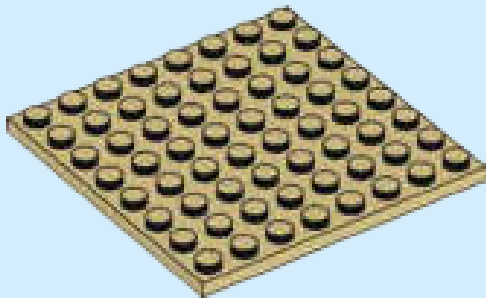

145

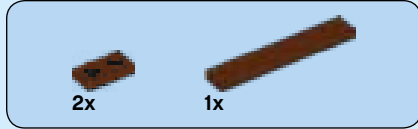
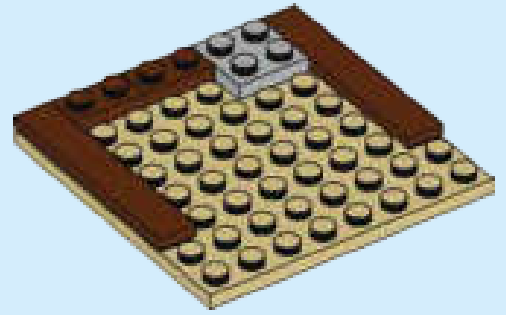

146

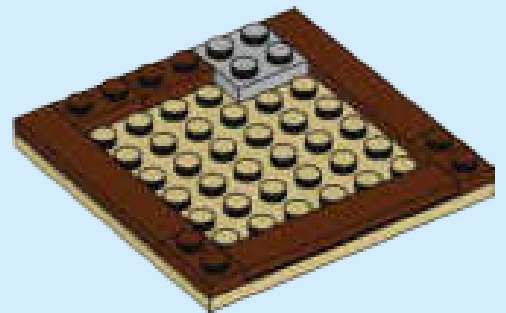

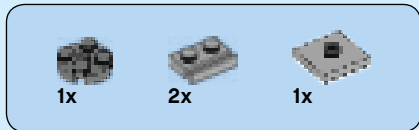

147



148

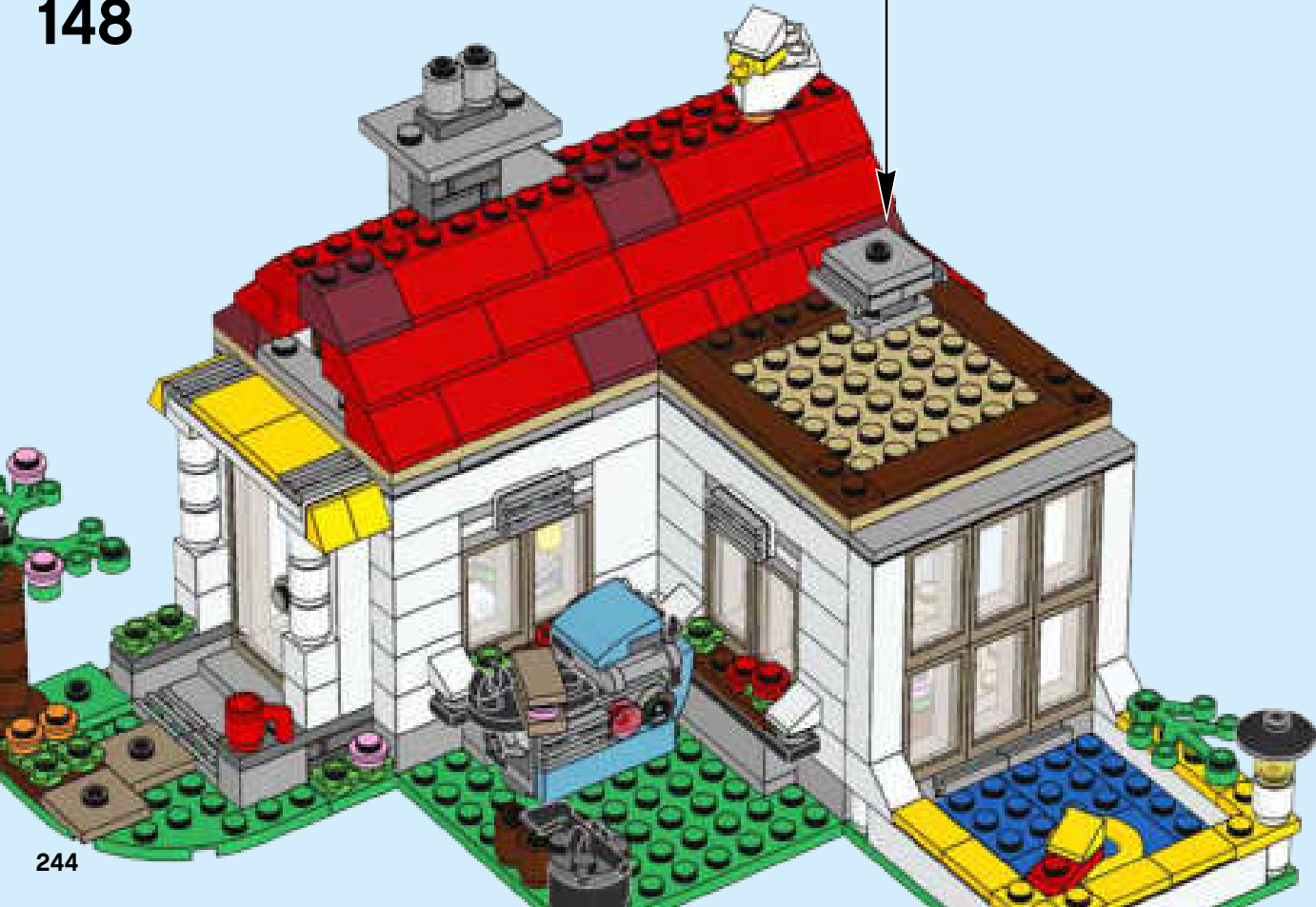



**149**

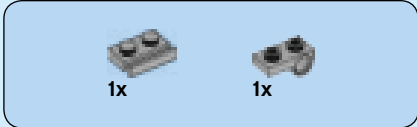
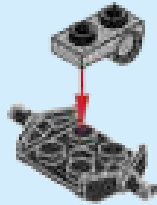

**150**



**151**



**152**





# 153

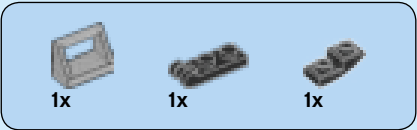



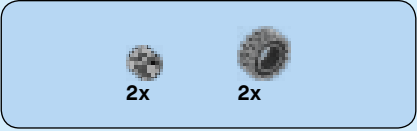
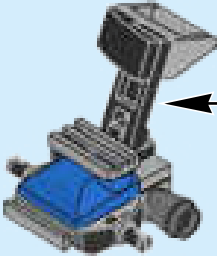

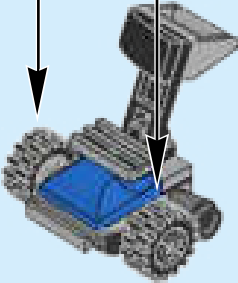
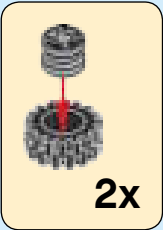

# 154

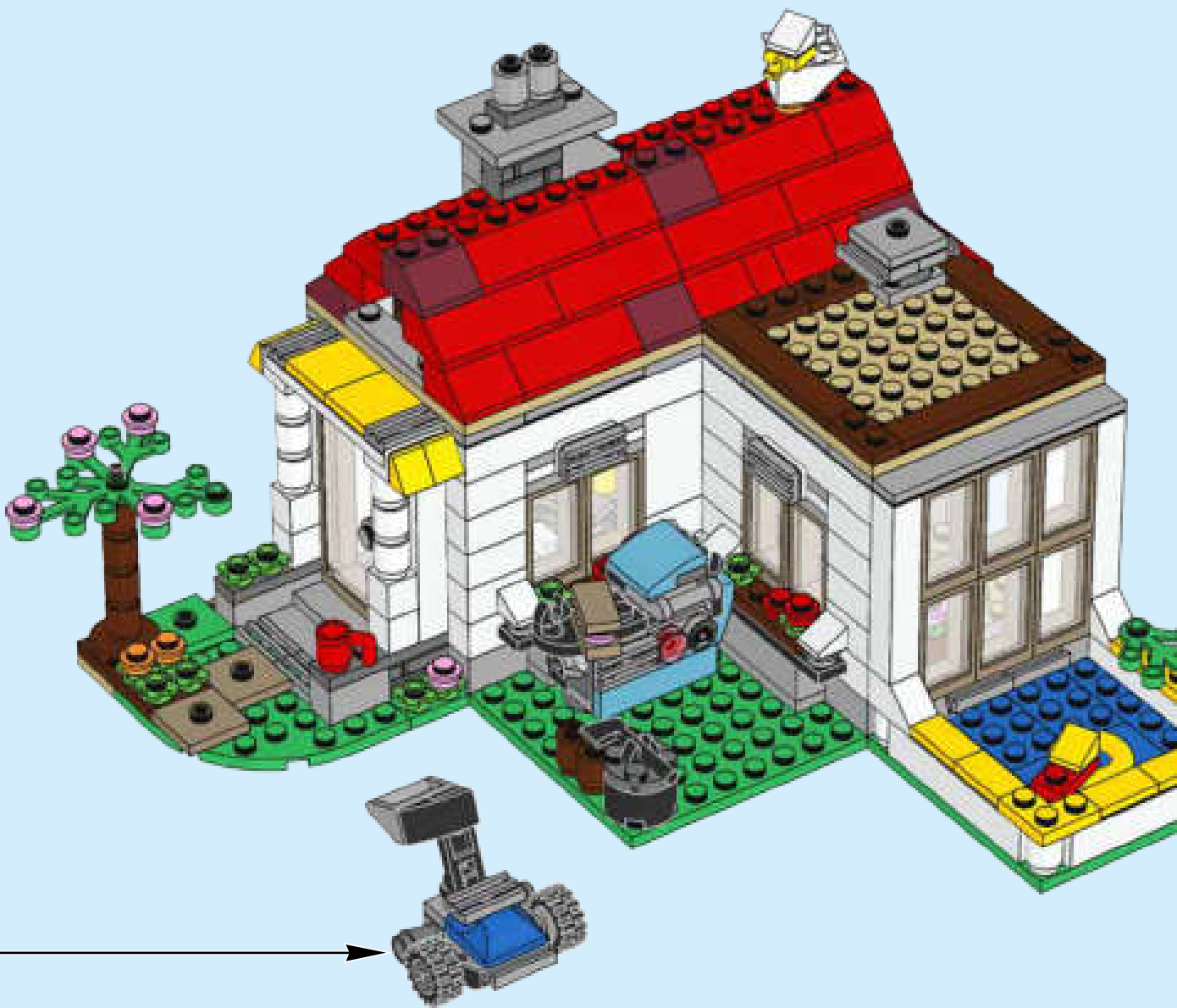

# 155





-  1x
-  4x
-  1x
-  2x
-  1x

# 157

1



2



3



4





5







		
1x	1x	1x

# 158

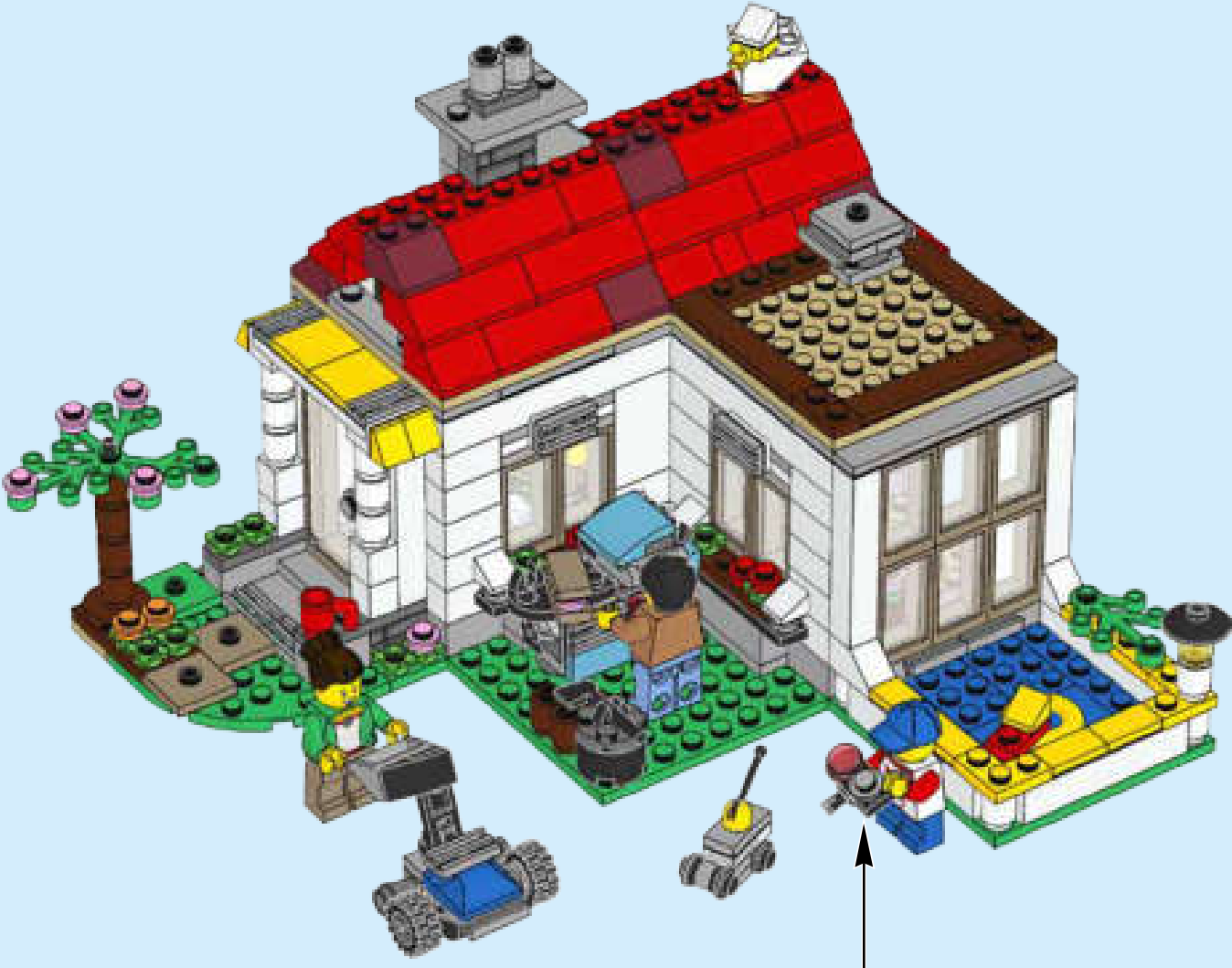

1		2	
---	---	---	---

1x 6121787	2x 4121932	4x 4211412	4x 6126082	2x 4529240	2x 6147050	1x 3006844
27x 306201	4x 6070698	6x 4211525	3x 4211397	2x 4558955	1x 4556158	1x 3005744
4x 614101	1x 6126046	4x 4211506	8x 6102357	5x 4211042	2x 4515368	2x 4646864
6x 4504369	30x 235701	1x 4211503	6x 4211349	4x 4211063	2x 6097283	1x 4649066
7x 302401	2x 6138740	4x 4211389	12x 6065824	3x 6000311	3x 362326	2x 4280341
6x 245301	6x 301001	1x 4533772	1x 6181755	4x 4211043	1x 4512727	3x 4157103
12x 300501	2x 365901	2x 4550325	4x 4211429	4x 4211001	1x 383526	6x 614121
1x 4600294	1x 6023806	2x 4632575	1x 6116608	1x 317626	1x 317626	1x 389921
4x 6133766	3x 4558208	8x 4211350	2x 4211386	1x 4560184	5x 302026	1x 302321
1x 6051511	5x 366601	2x 4211357	15x 4211356	4x 614126	1x 6081988	1x 9552
2x 6057414	3x 4620761	2x 6066097	7x 4211394	2x 4289538	1x 366626	10x 4121934
2x 306901	10x 300901	8x 6089147	21x 4599498	2x 6066102	4x 4578677	2x 303921
2x 302301	2x 379501	8x 4211388	4x 4211395	1x 474026	7x 403226	2x 4515360
4x 4113261	3x 6079461	2x 4211614	3x 4211385	2x 614326	1x 474026	13x 303721
10x 300401	1x 4244627	4x 4654580	3x 6079461	1x 4121715	5x 4167842	2x 367521
1x 4521848	6x 300801	8x 4211568	1x 4211481	2x 452826	2x 306540	2x 4560179
8x 245401	2x 246501	1x 4244627		1x 6122656	1x 4521504	1x 6143263
				1x 4593678	1x 6069068	2x 300821
				4x 241226	1x 4167504	

4x 4619520  
 1x 6132411  
 2x 6119126  
 2x 4624705  
 1x 4625036  
 3x 407023  
 2x 6055424  
 2x 300523  
 1x 4206482  
 1x 6092582  
 3x 302223  
 3x 6116786  
 2x 4496366  
 3x 371023  
 2x 302023  
 2x 4560180  
 2x 366623  
 1x 4243815  
 4x 4153653

1x 74156  
 6x 4504381  
 3x 302424  
 1x 4540040  
 1x 287724  
 2x 4188357  
 7x 306924  
 1x 4527354  
 2x 6079007  
 3x 306824  
 4x 242024  
 4x 4558172  
 2x 362224  
 1x 4528550  
 1x 6118828  
 1x 6019725  
 2x 371024  
 3x 302024

1x 6146234  
 2x 4496699  
 2x 4528604  
 13x 6151557  
 5x 6126075  
 2x 6188109  
 18x 6170300  
 1x 4565321  
 1x 242328  
 1x 4613823  
 1x 379528  
 1x 6021999  
 2x 4161677  
 4x 4539105  
 8x 4609925  
 1x 6030360

8x 4211183  
 6x 4221744  
 3x 4504376  
 1x 6102360  
 3x 4223303  
 1x 4595814  
 6x 4211150  
 1x 6142949  
 8x 4211186  
 3x 4211204  
 1x 4277751  
 1x 4223729

1x 4205107  
 3x 4185177  
 4x 4162465  
 1x 6031057  
 1x 4114324  
 1x 4113988  
 1x 4509897  
 4x 4624223  
 2x 4609726  
 1x 4654448

9x 4517996  
 1x 6126113  
 3x 6170577  
 1x 6030333  
 1x 4653226  
 1x 6158322  
 1x 6032176  
 1x 6021844  
 1x 6116616  
 1x 4584727  
 1x 6152800  
 1x 6100844  
 1x 6153139  
 1x 6047056  
 1x 4524098  
 1x 4543857



**Customer Service**  
 Kundenservice  
 Service Consommateurs  
 Servicio Al Consumidor  
 LEGO.com/service or dial

 : 00800 5346 5555  
 : 1-800-422-5346



CREATOR

3<sup>IN</sup>1



31067



31068



31069



**CREATOR**

31070

**3<sup>IN</sup>1**





# BOOST

BUILD | CODE | PLAY



LEGO  
BOOST



17101



# WORLDS

OUT NOW / MAINTENANT DISPONIBLE / JETZT ERSCHIENEN  
YA DISPONIBLE / JÁ DISPONÍVEL / MEGJELENT / 现已上市  
OFFERT DÈS MAINTENANT / YA ESTÁ DISPONIBLE



[LEGO.com/worlds](http://LEGO.com/worlds)

LEGO WORLDS software © 2017 TT Games Ltd. Produced by TT Games under license from the LEGO Group. LEGO, the LEGO logo, the Brick and the Knob configurations and the Minifigure are trademarks of the LEGO Group. © 2017 The LEGO group. All other trademarks and copyrights are the property of their respective owners. All rights reserved. WB GAMES LOGO, WB SHIELD.™ & © Warner Bros. Entertainment Inc. (s17) Separate purchase required.



# WIN

GO TO [WWW.LEGO.COM/PRODUCTFEEDBACK](http://WWW.LEGO.COM/PRODUCTFEEDBACK)  
AND GIVE US YOUR SHORT **FEEDBACK**  
ABOUT THIS LEGO® SET FOR A CHANCE  
TO WIN A COOL LEGO PRIZE.

Terms & Conditions apply

## LEGO.com/productfeedback

### GEWINNE

Erzähle uns auf  
[www.LEGO.com/productfeedback](http://www.LEGO.com/productfeedback)

etwas über die Erfahrungen, die du mit  
diesem LEGO® Set gemacht hast, und  
sichere dir die Chance auf einen coolen  
LEGO Preis!

Es gelten die Teilnahmebedingungen

### GAGNE

Rends-toi sur  
[www.LEGO.com/productfeedback](http://www.LEGO.com/productfeedback)

et donne-nous quelques commentaires  
sur ce produit LEGO® pour avoir une  
chance de gagner un prix LEGO !

Voir Conditions Générales

### GANAN

Visita  
[www.LEGO.com/productfeedback](http://www.LEGO.com/productfeedback)

y envíanos tu opinión acerca de este  
set LEGO®. ¡Participarás en el sorteo  
de un premio LEGO!

Términos y Condiciones aplicables

### 获取奖品

登录  
[www.LEGO.com/productfeedback](http://www.LEGO.com/productfeedback)

给出关于此乐高®套装的简短反馈，  
就有机会获得炫酷乐高奖品

《条款及条件》适用

### 경품 당첨 기회

[www.LEGO.com/productfeedback](http://www.LEGO.com/productfeedback)

페이지로 이동하여 이 레고® 세트에 대한  
간략한 피드백을 보내 주시고 멋진 레고  
경품을 탈 수 있는 기회도 잡으십시오

약관 적용

### ЗАПОЛНИ АНКЕТУ И ПОЛУЧИ ПРИЗ

Перейди по ссылке  
[www.LEGO.com/productfeedback](http://www.LEGO.com/productfeedback)

ответь всего на несколько вопросов  
об этом наборе LEGO®, и у тебя появ-  
вится шанс выиграть замечательный  
приз от компании LEGO.

Применяются Условия и правила  
участия