



1

X1 X1 X1

2

X1 X1 X1 X1 X1 X1 X1 X1 X1 X1 X1 X1 X1 X2 X5

3

X1 X3 X6 X6 X2 X2

X6

X2

4

X1 X1 X2 X2

5

X2 X1 X1

6

X1 X2 X1 X1 X1

7

X1 X1 X1

8

X1 X1

9

X12

X6

10

X2 X1 X1

11

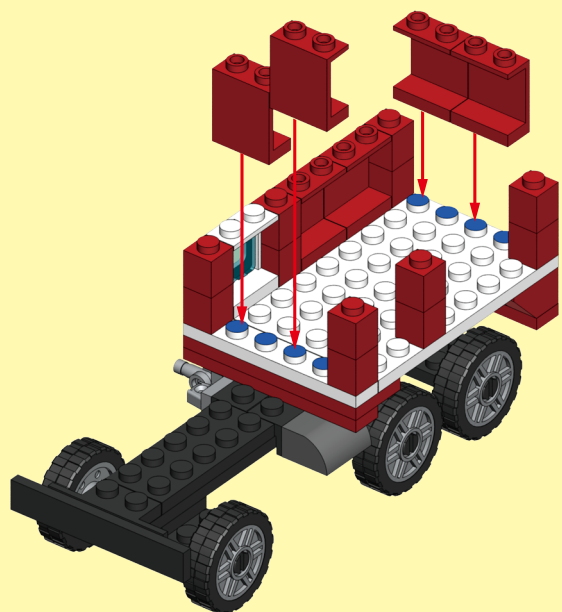
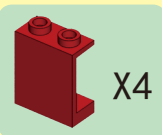

12

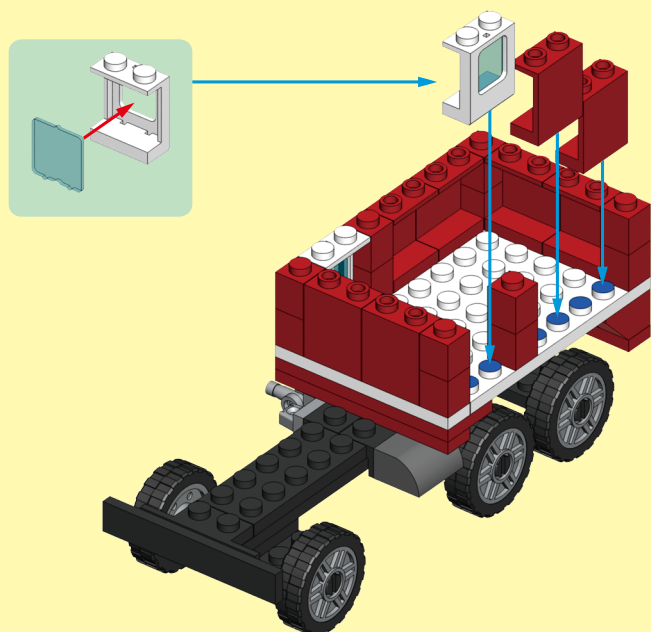
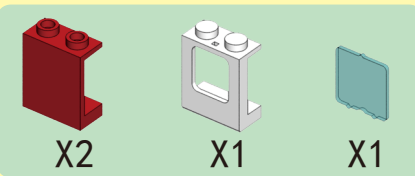

13

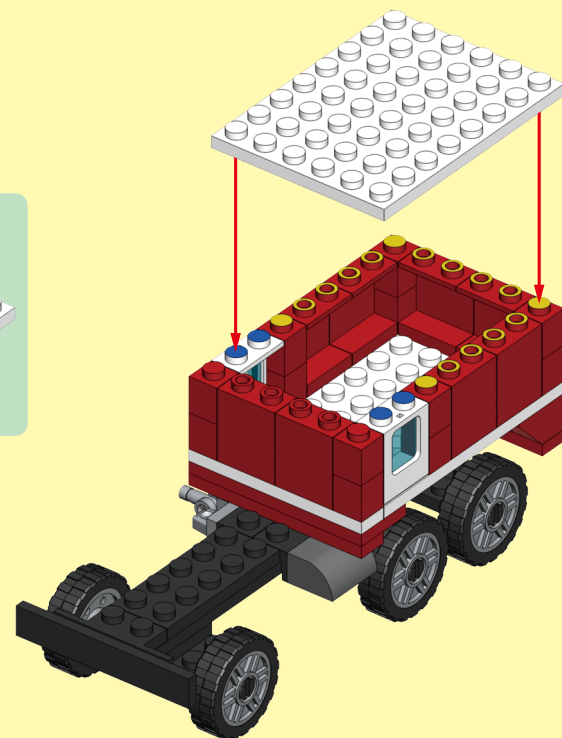
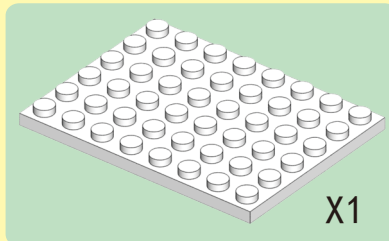

14

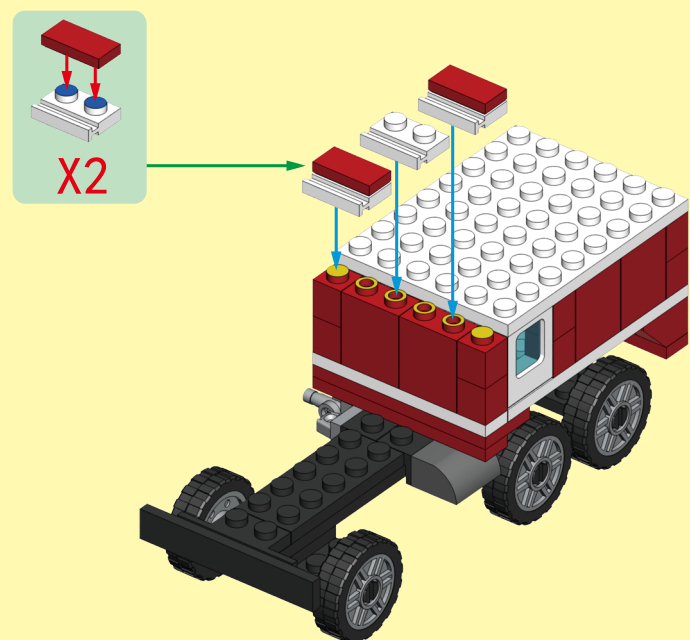
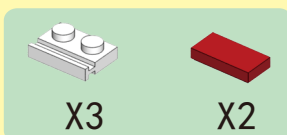

15

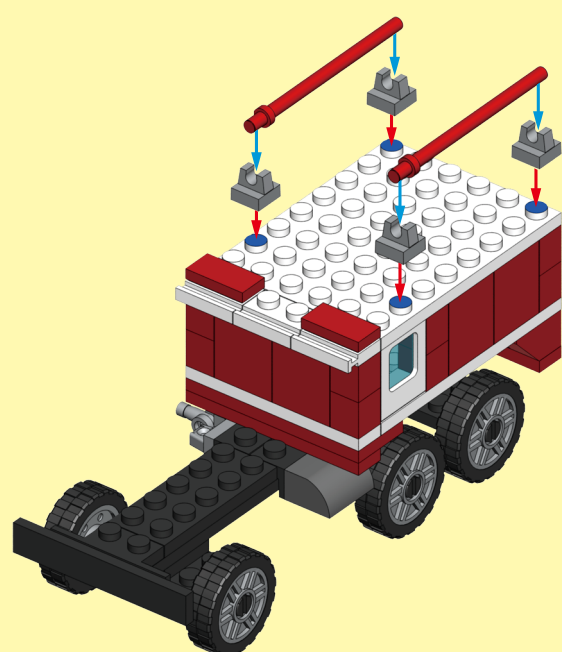
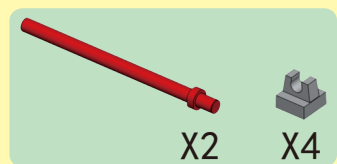

16

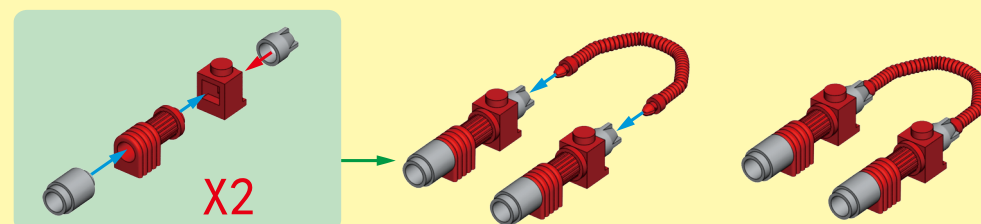
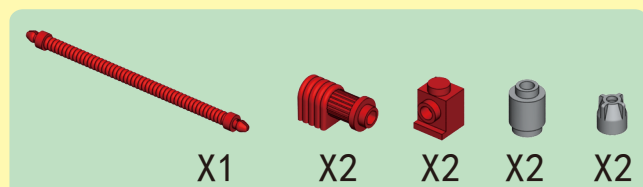

17

15 + 16

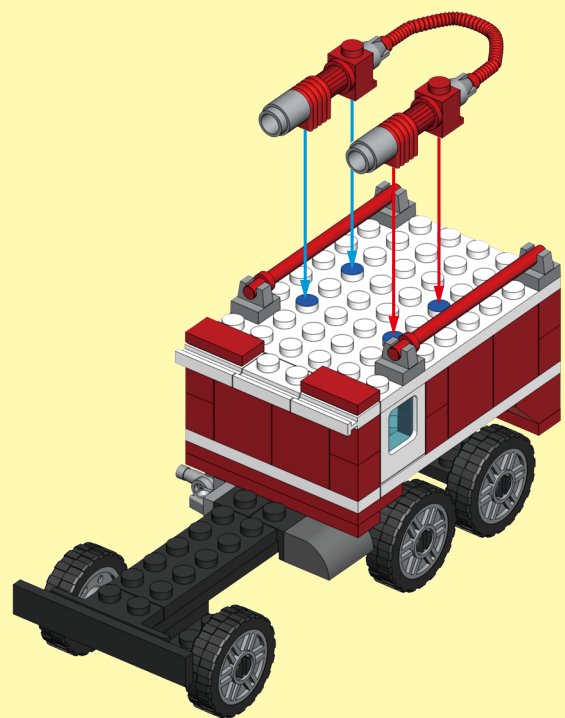

18

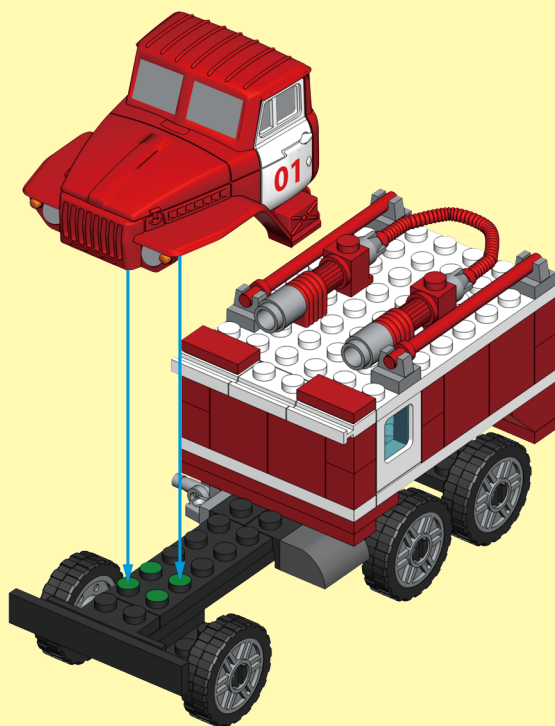
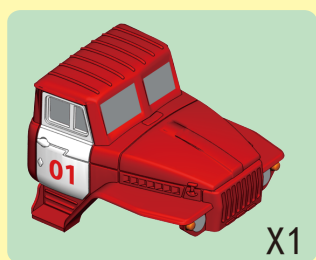

19

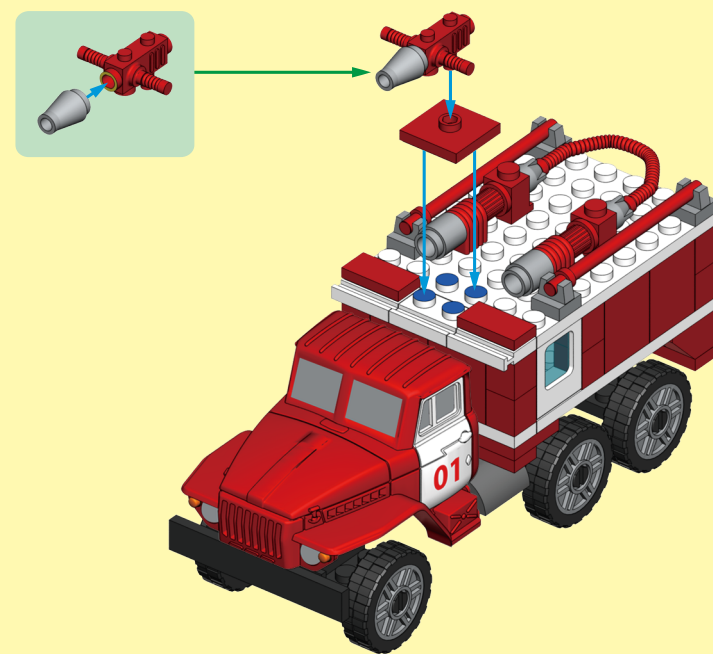
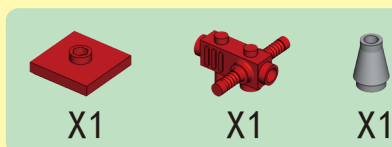

20

1 + 2 + 19

