

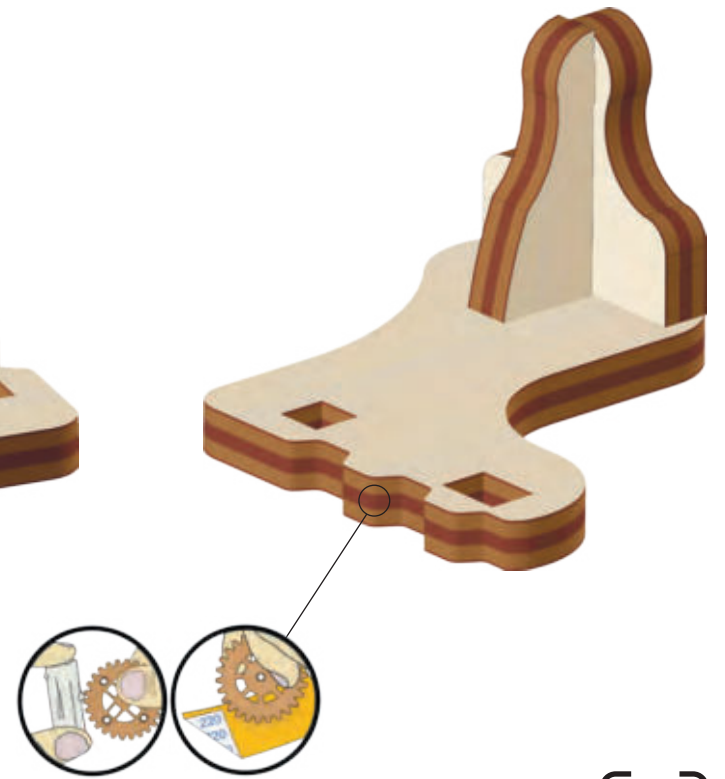

Wood Trick®

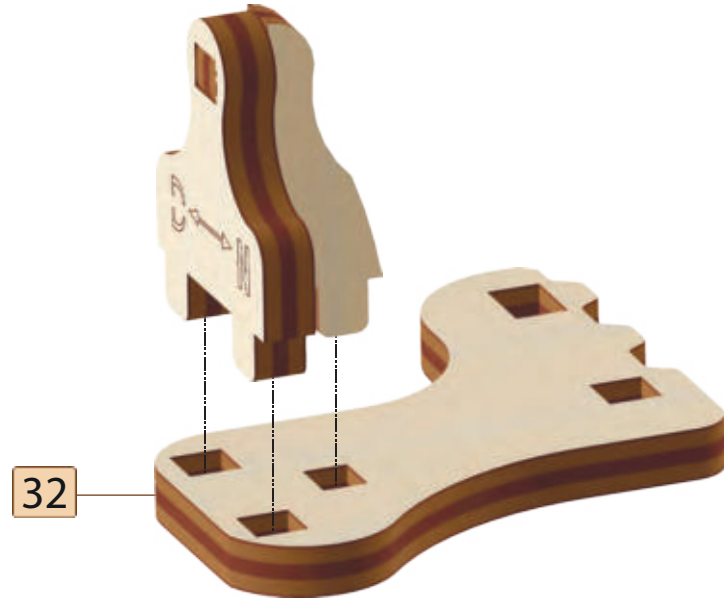

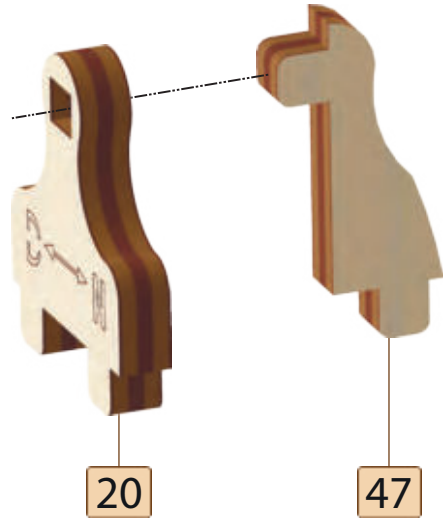
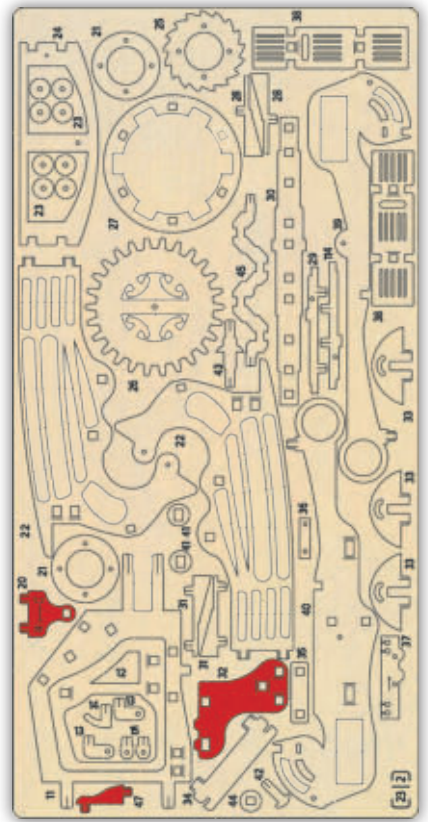
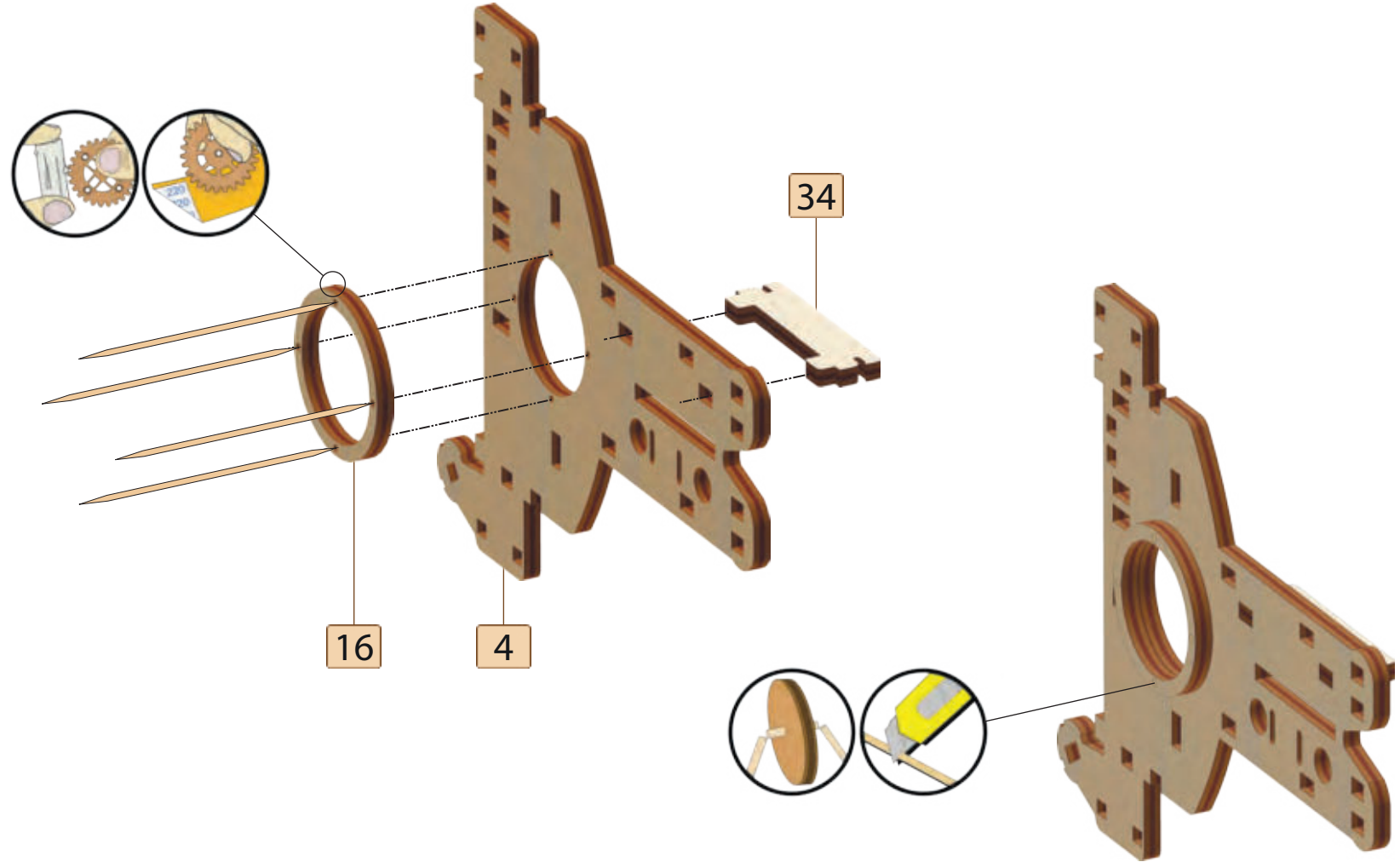
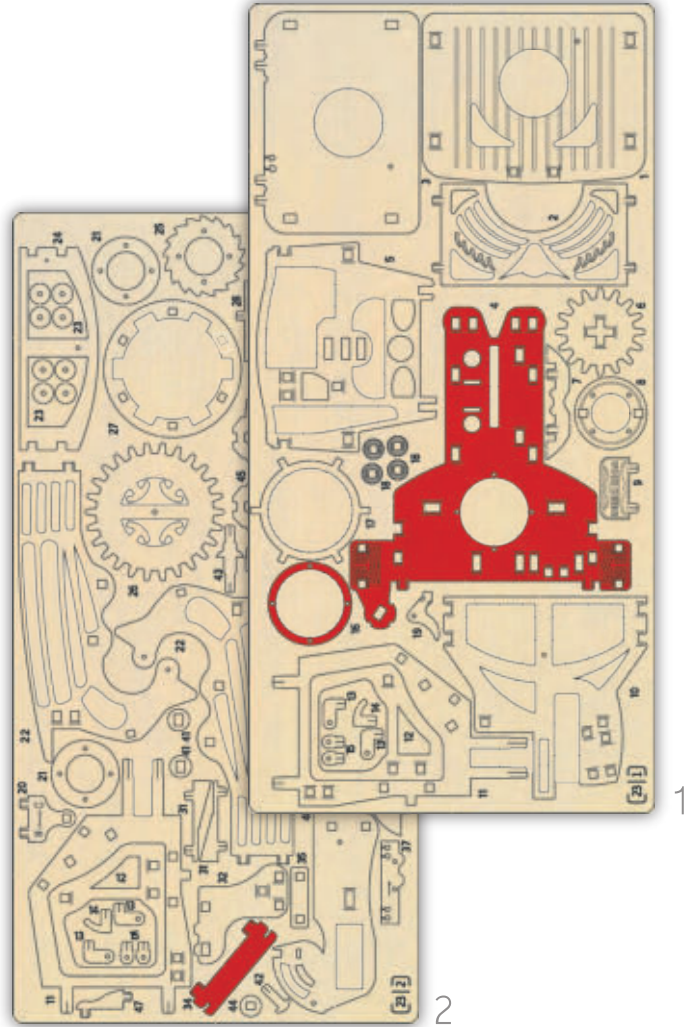

[2]

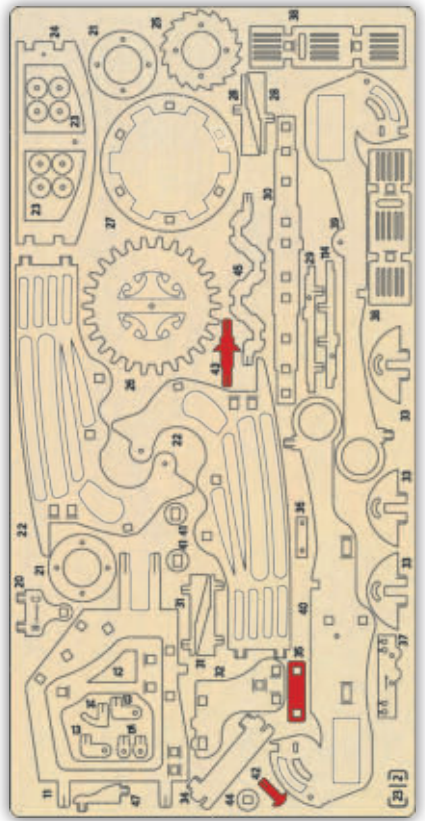

2

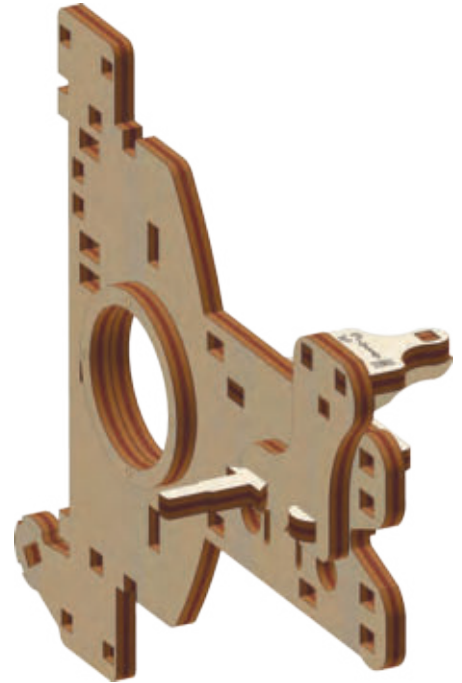
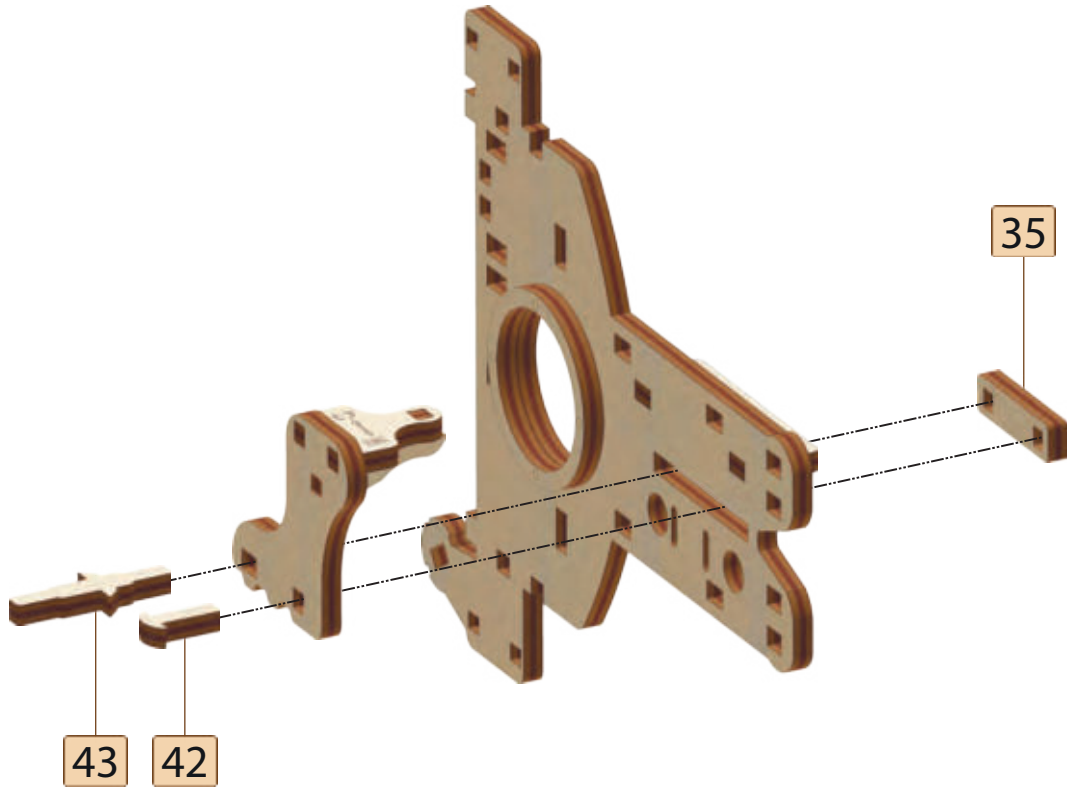

[3]

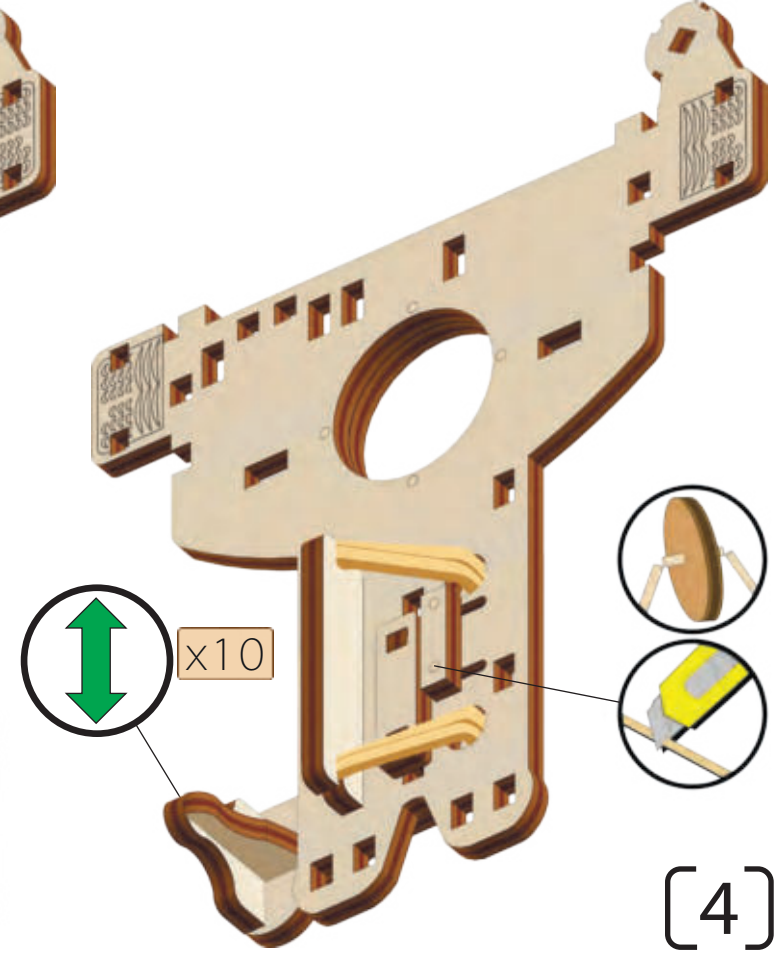
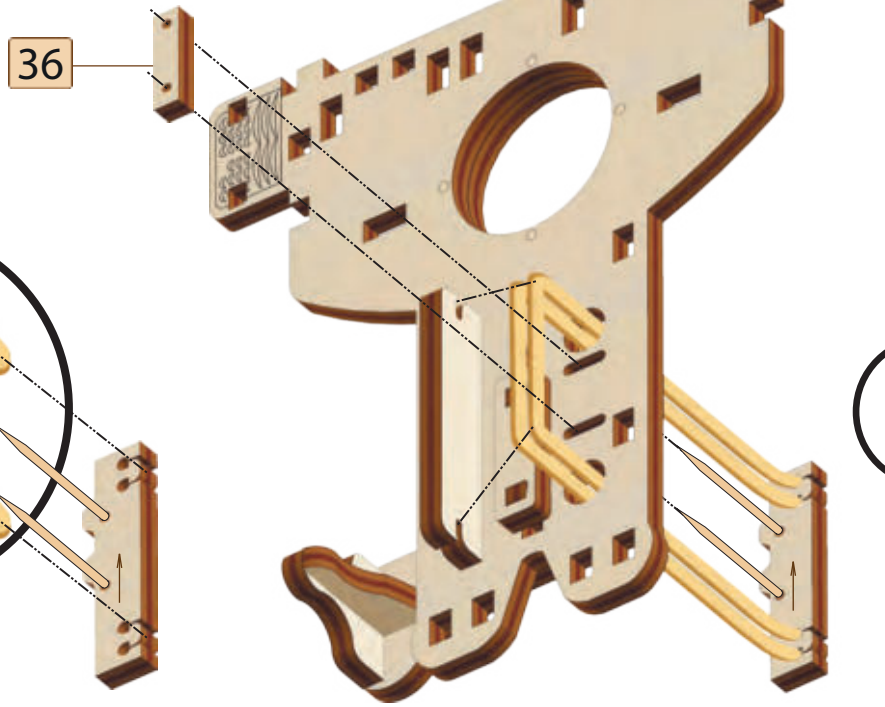
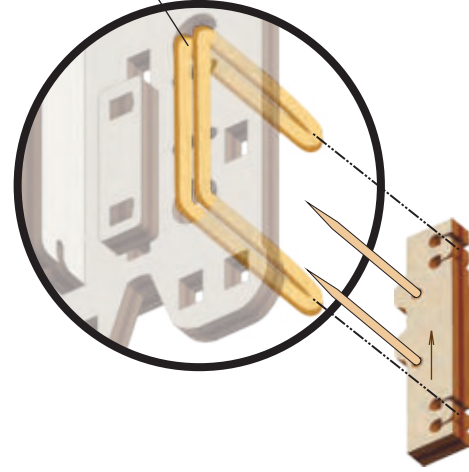
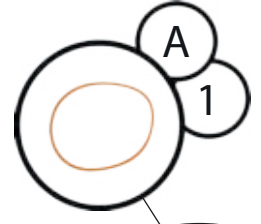
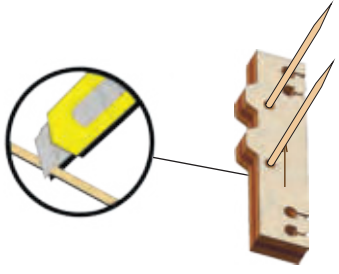
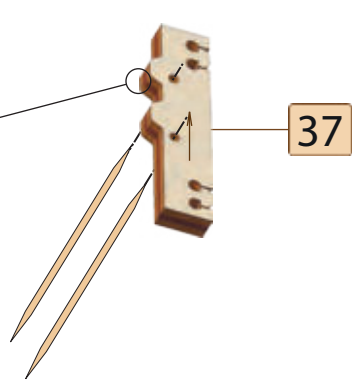
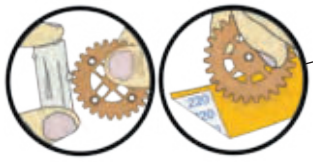
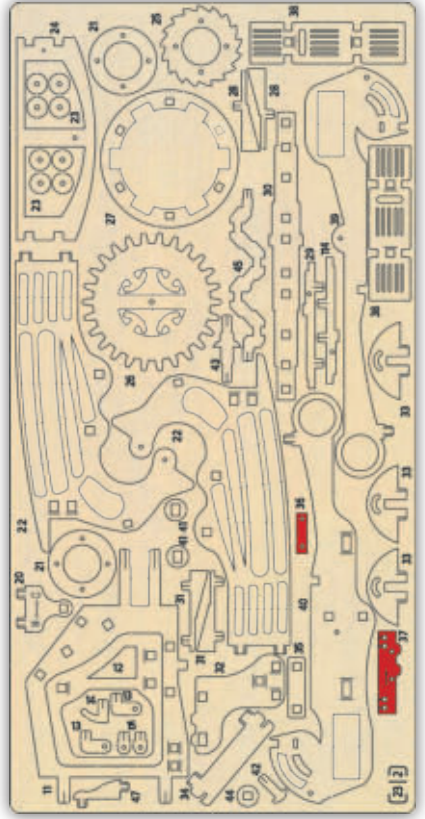

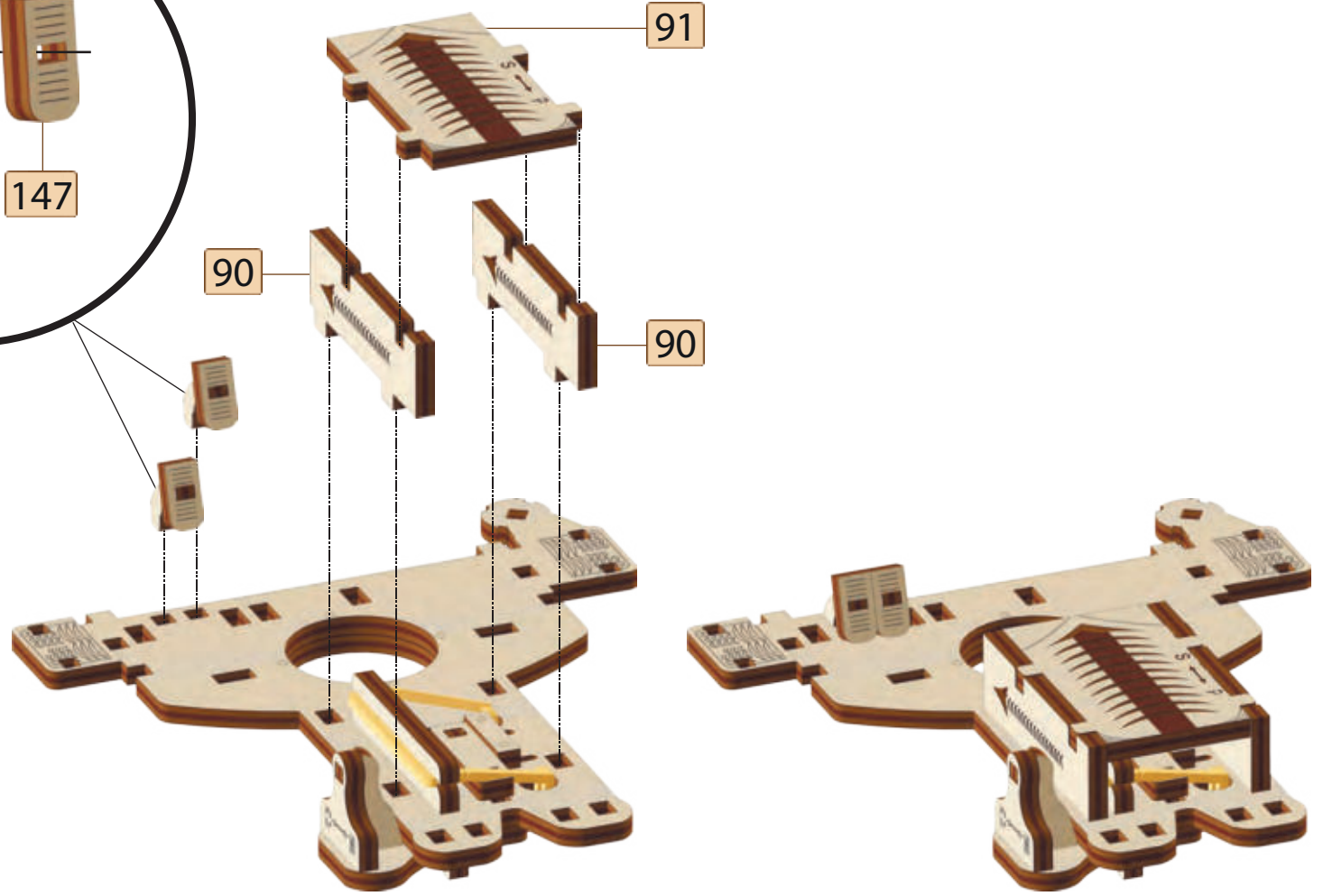
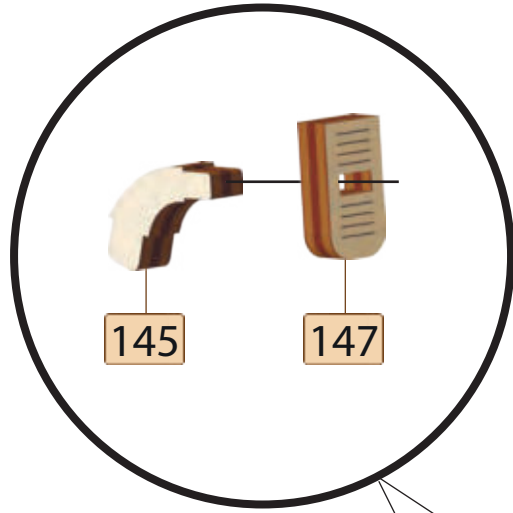
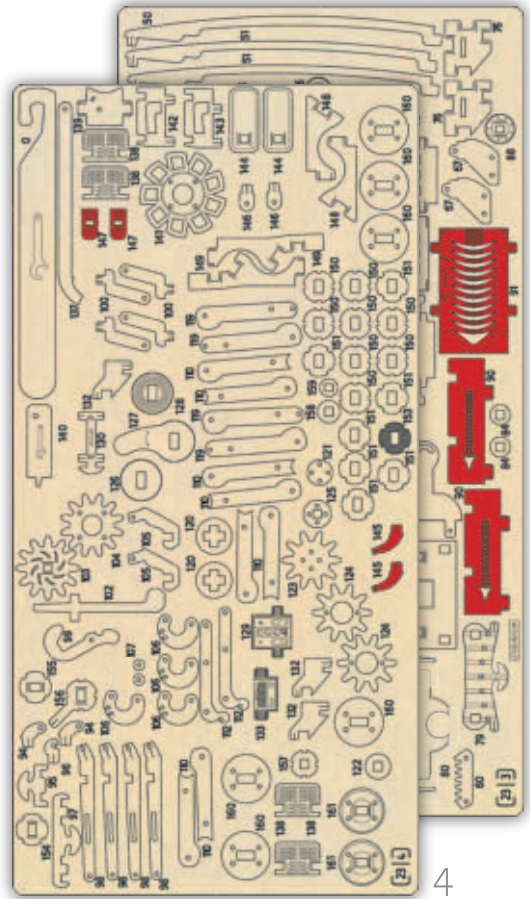

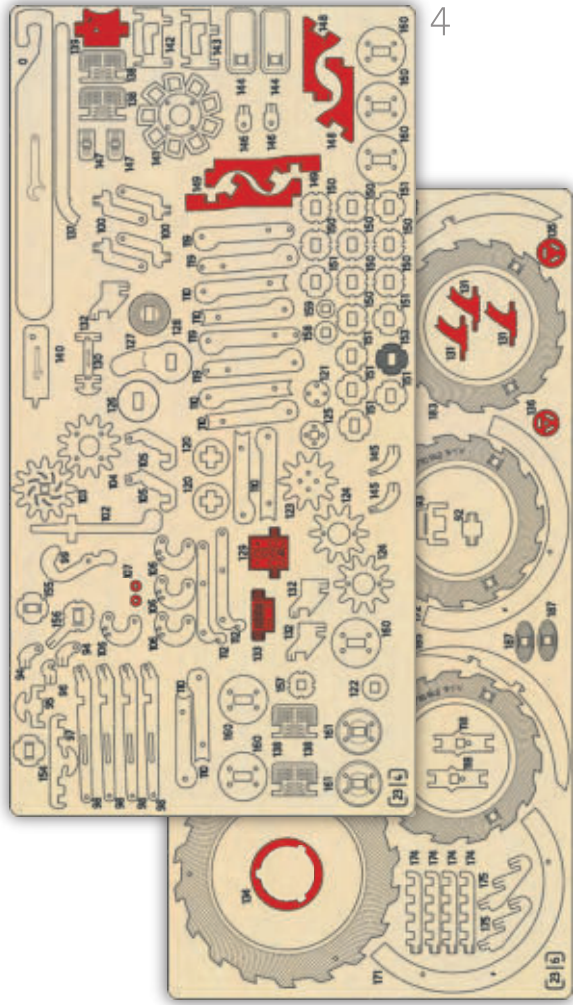

4

6

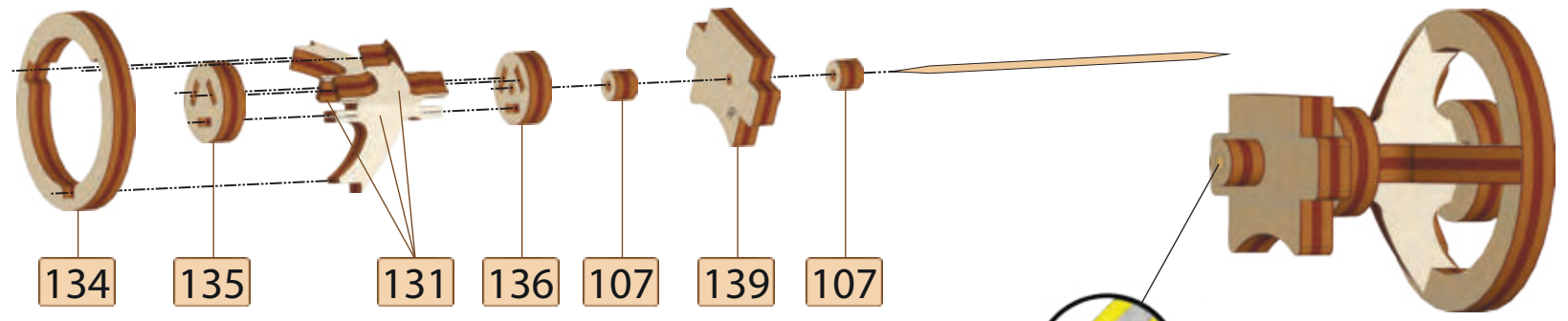

134

135

131

136

107

139

107

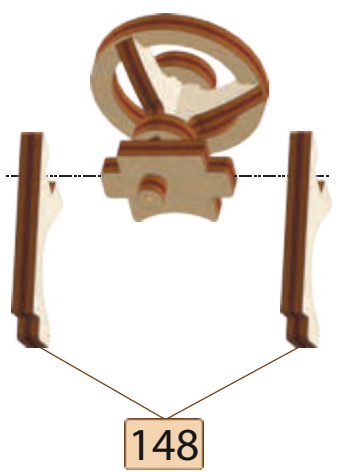

148

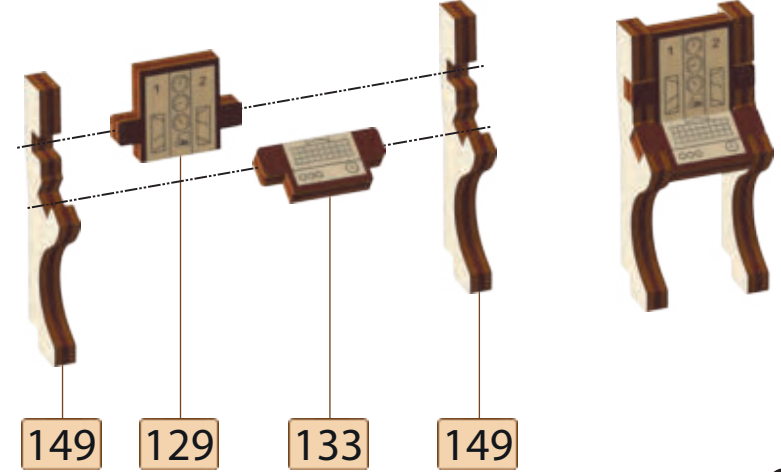

149

129

133

149

[6]





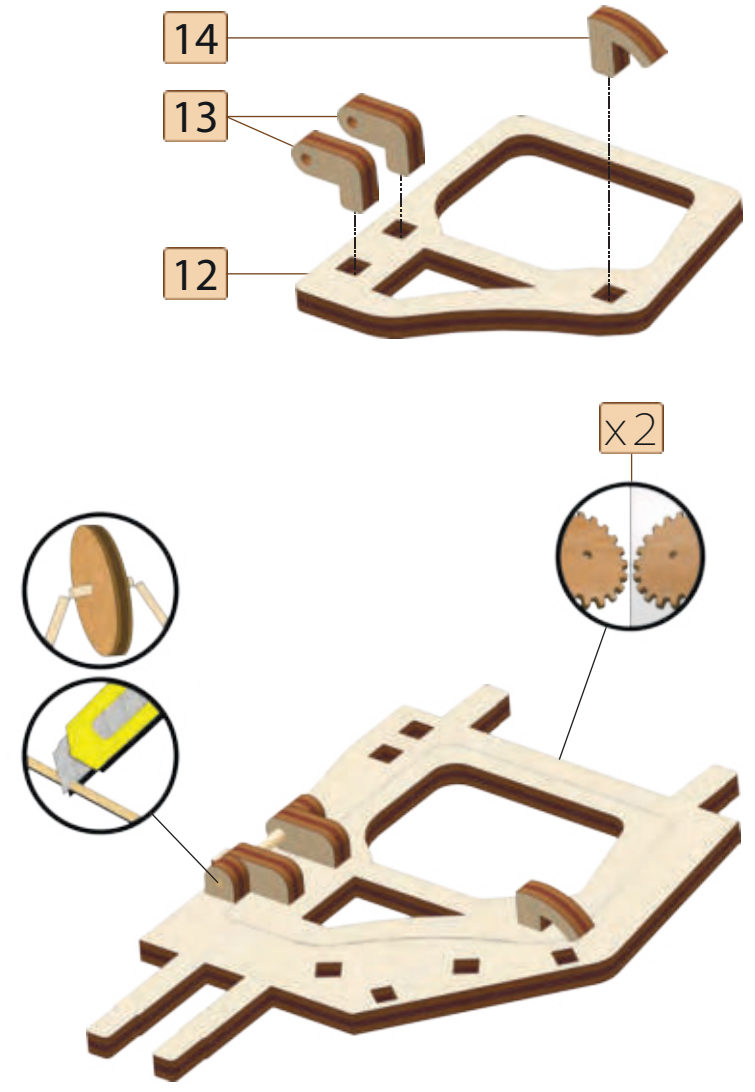
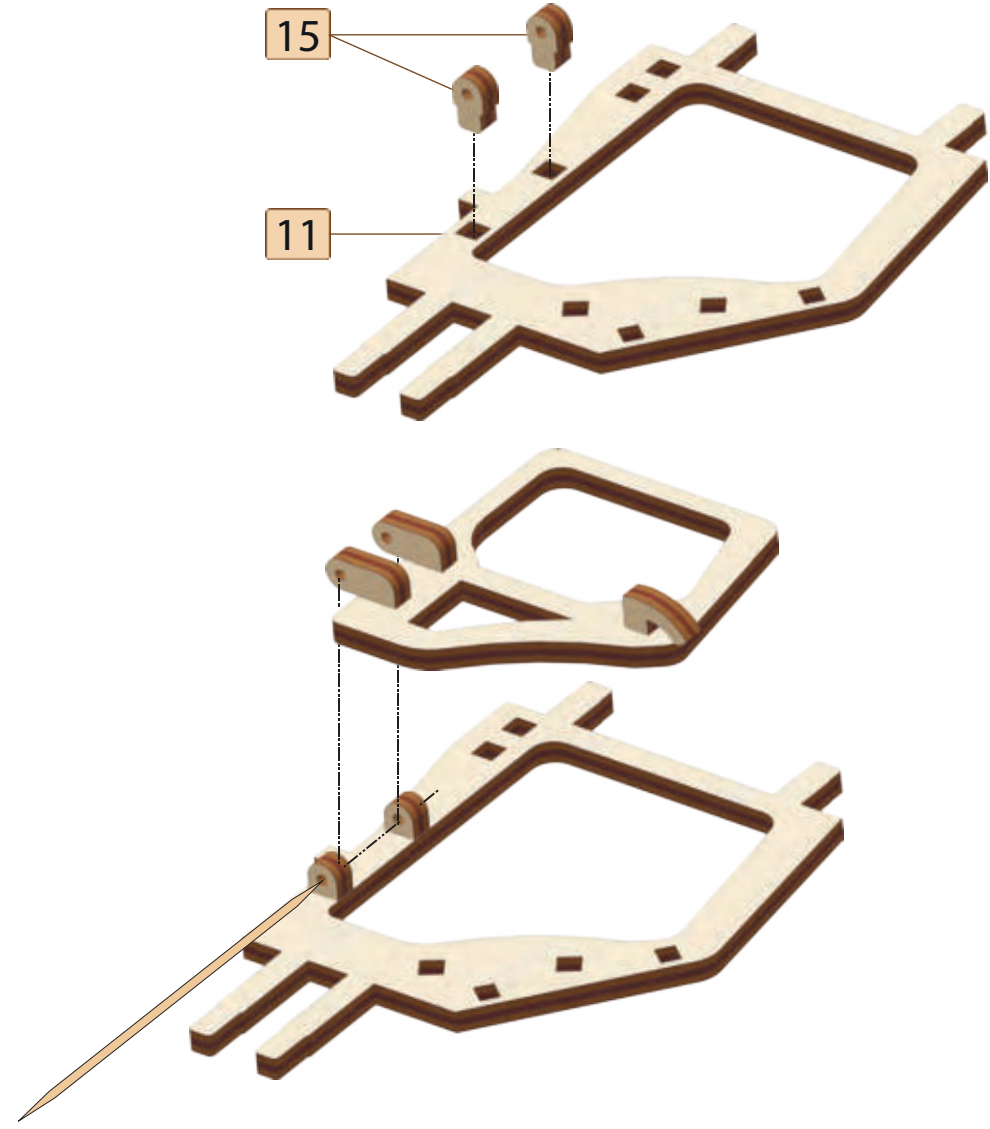
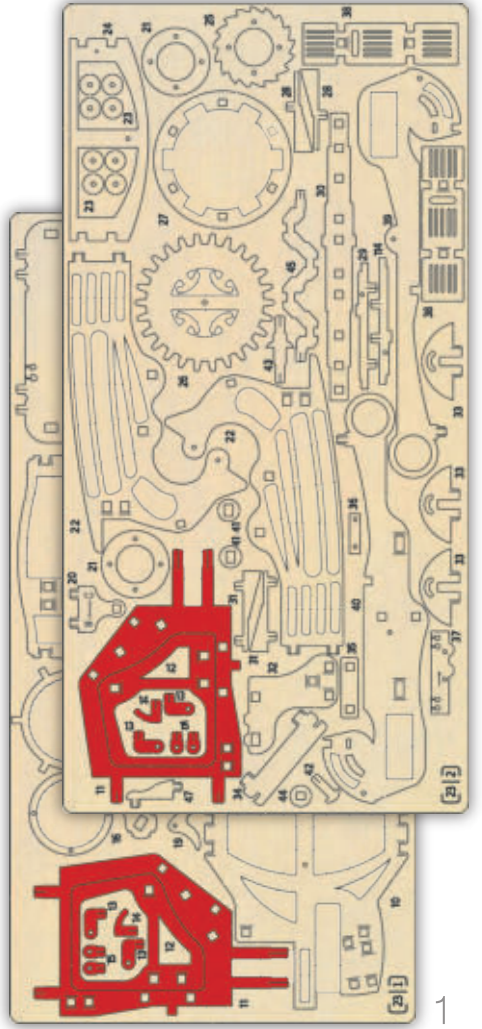

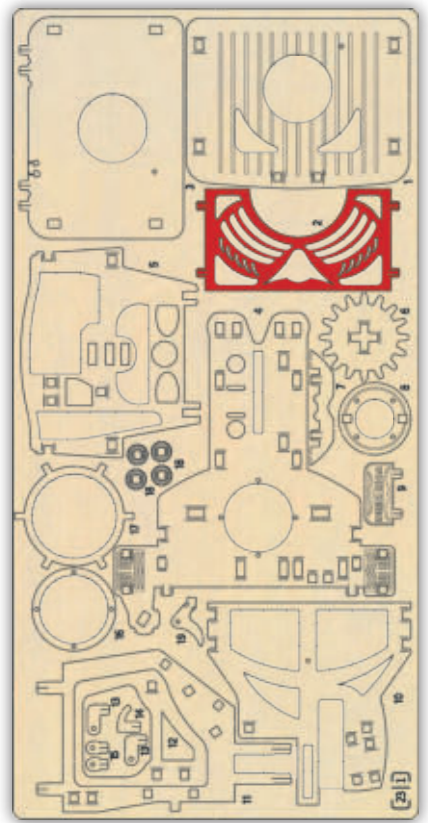

1

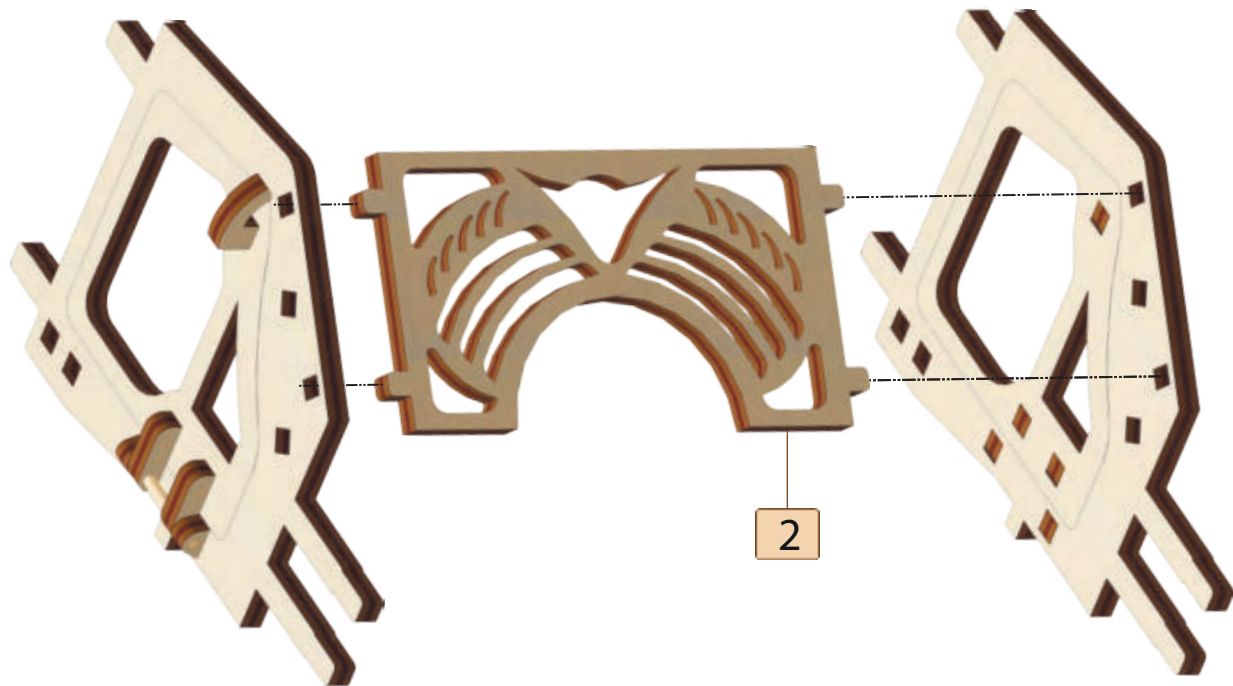

2



[9]

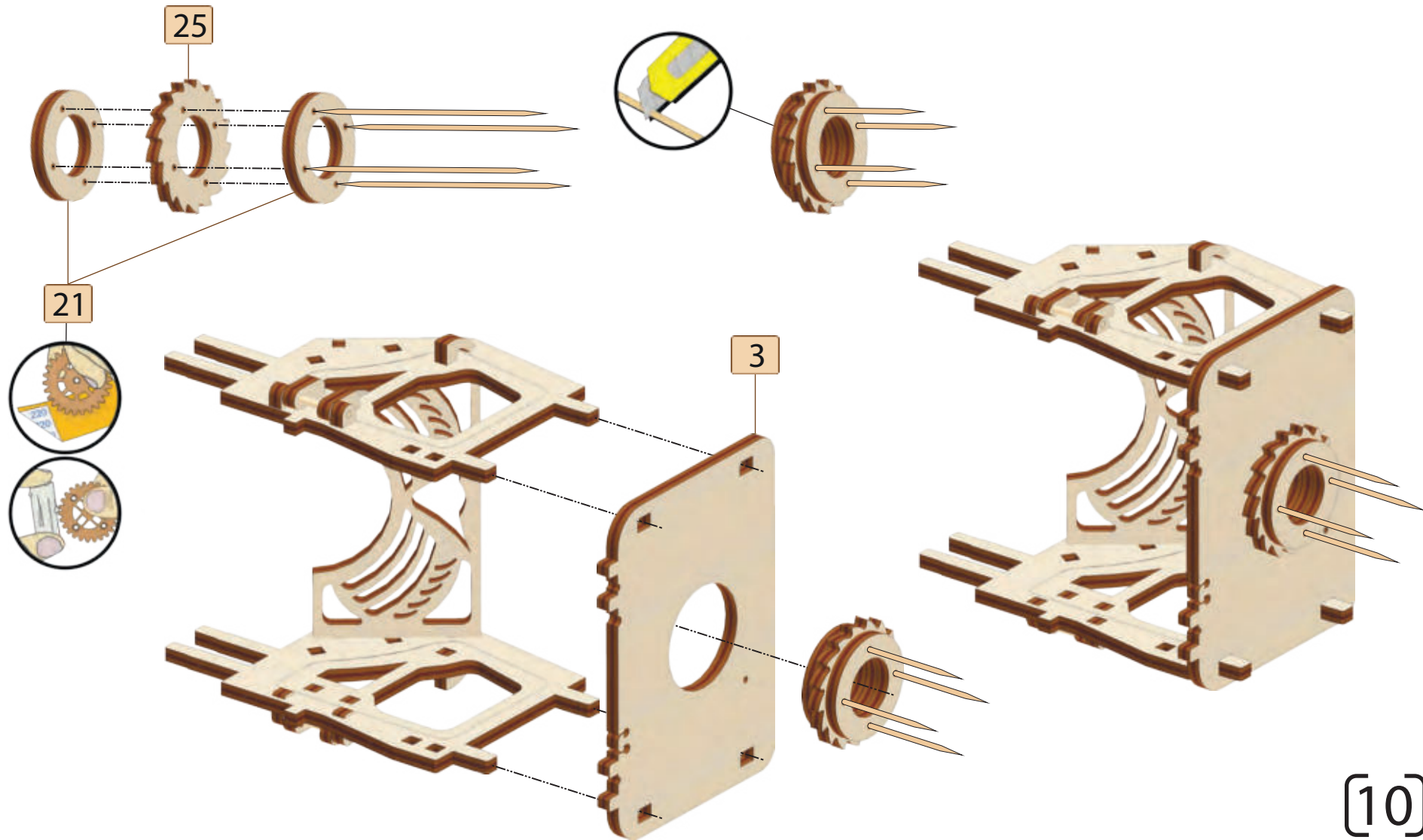
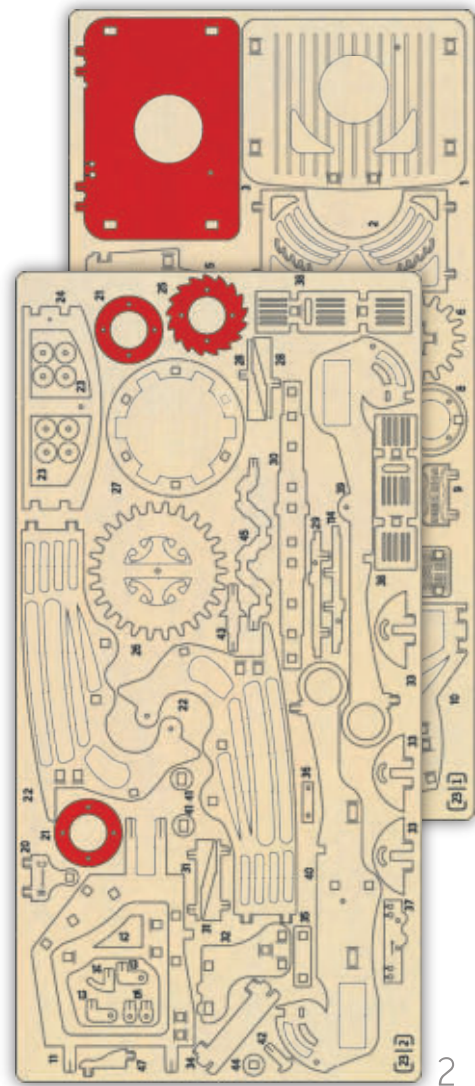

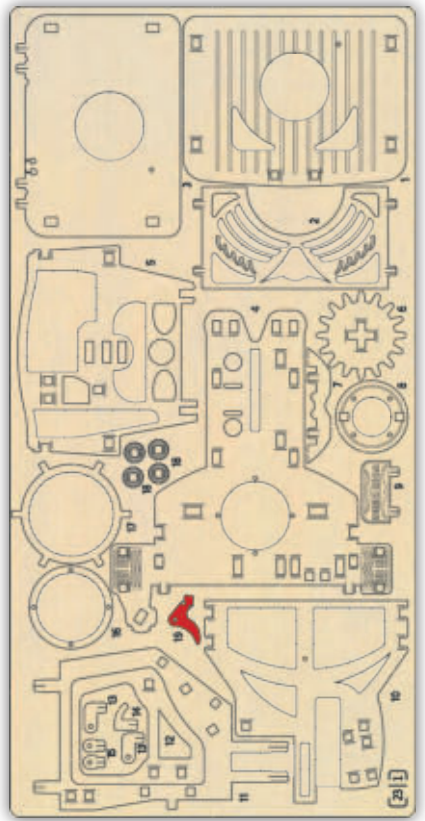

1

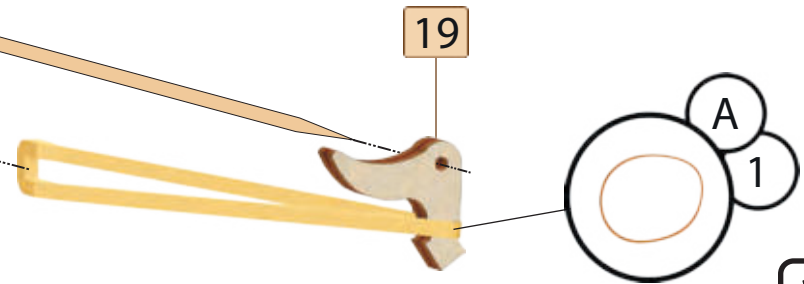
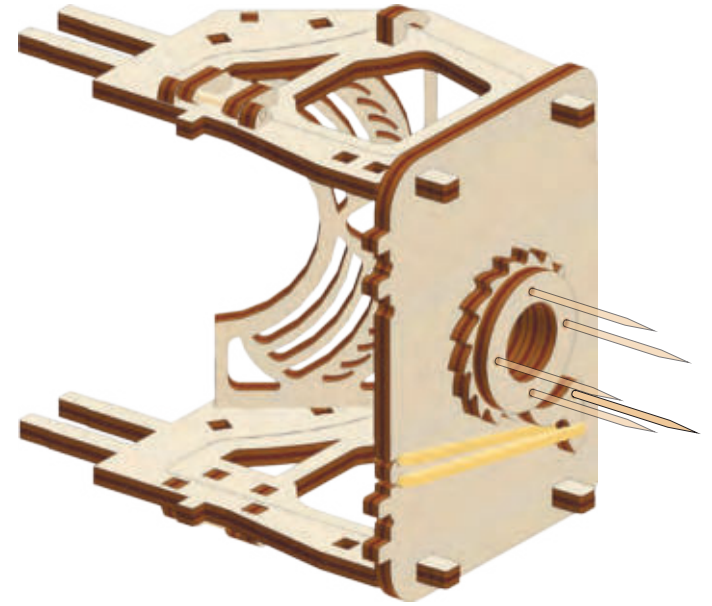
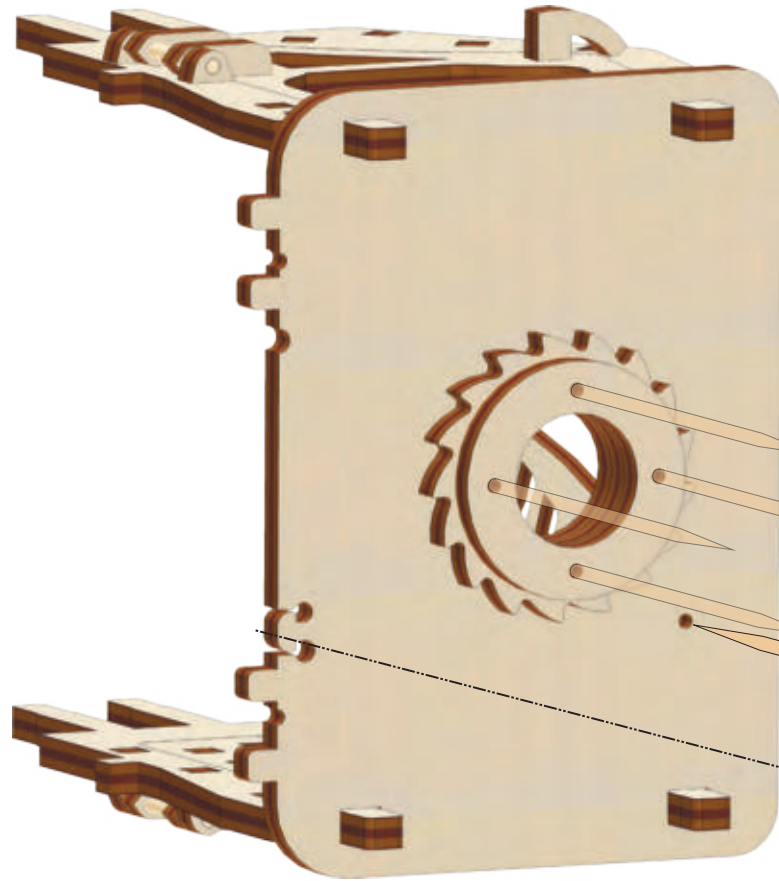

[11]

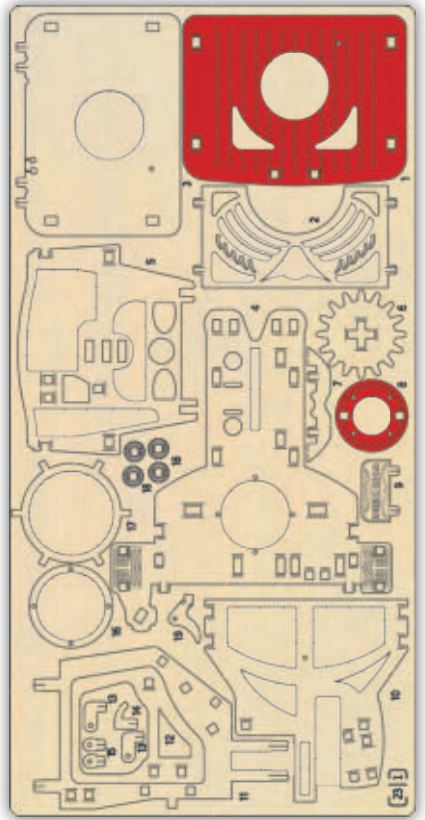

1

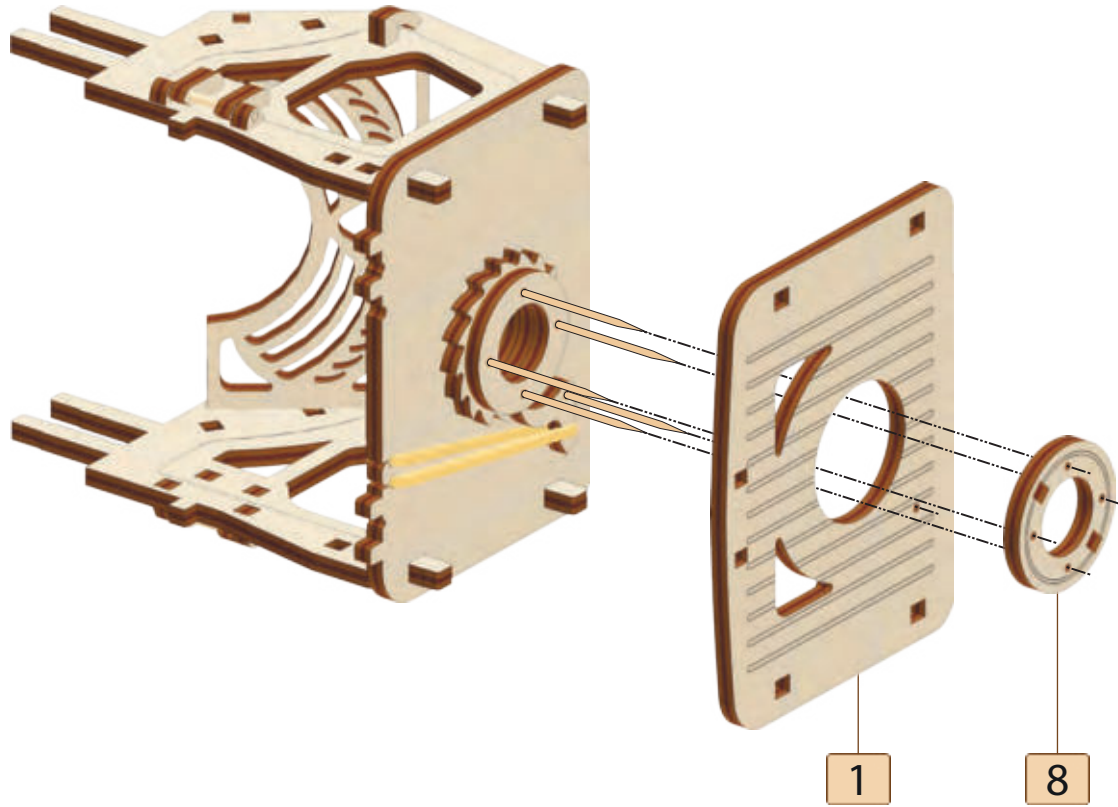

1

8

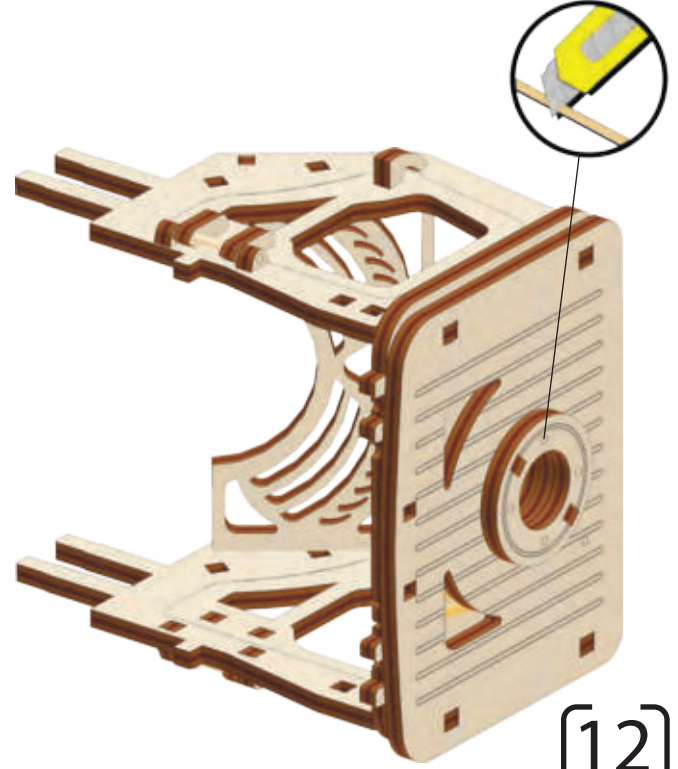

[12]



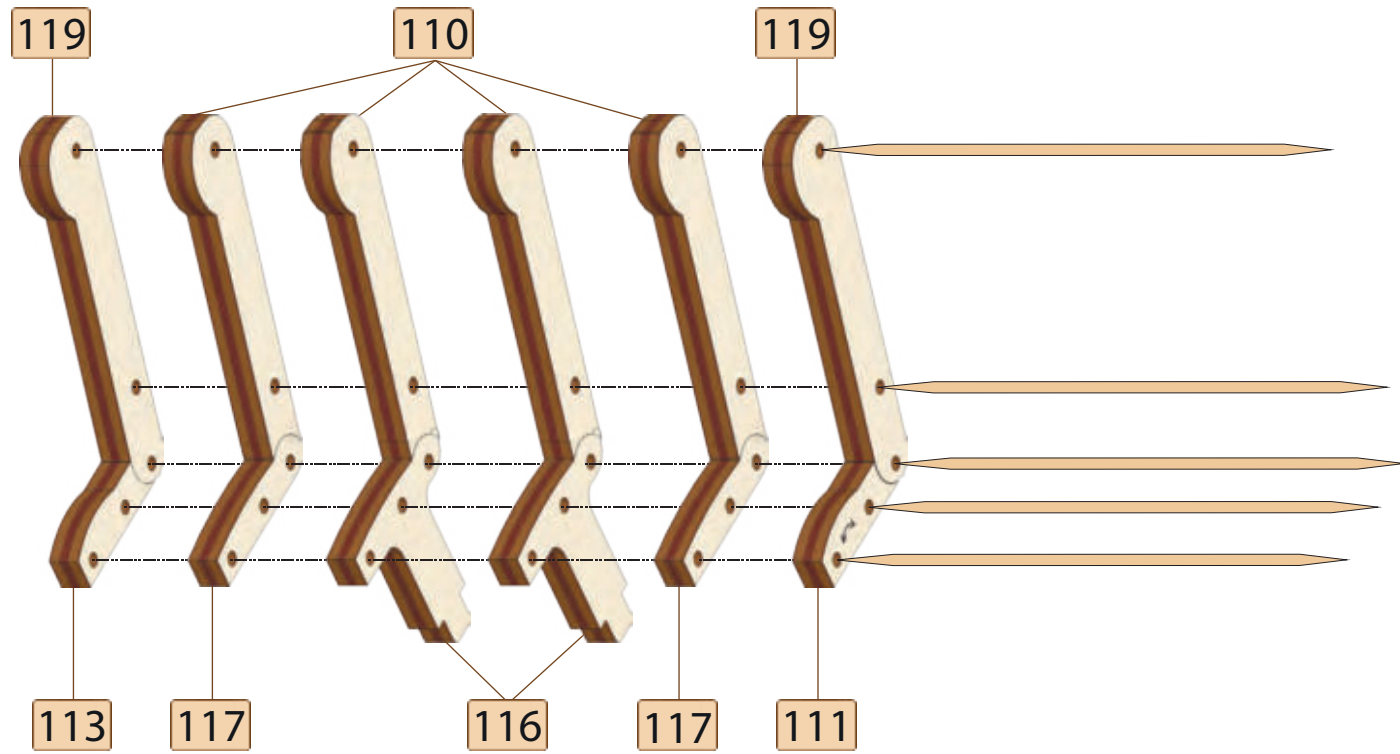
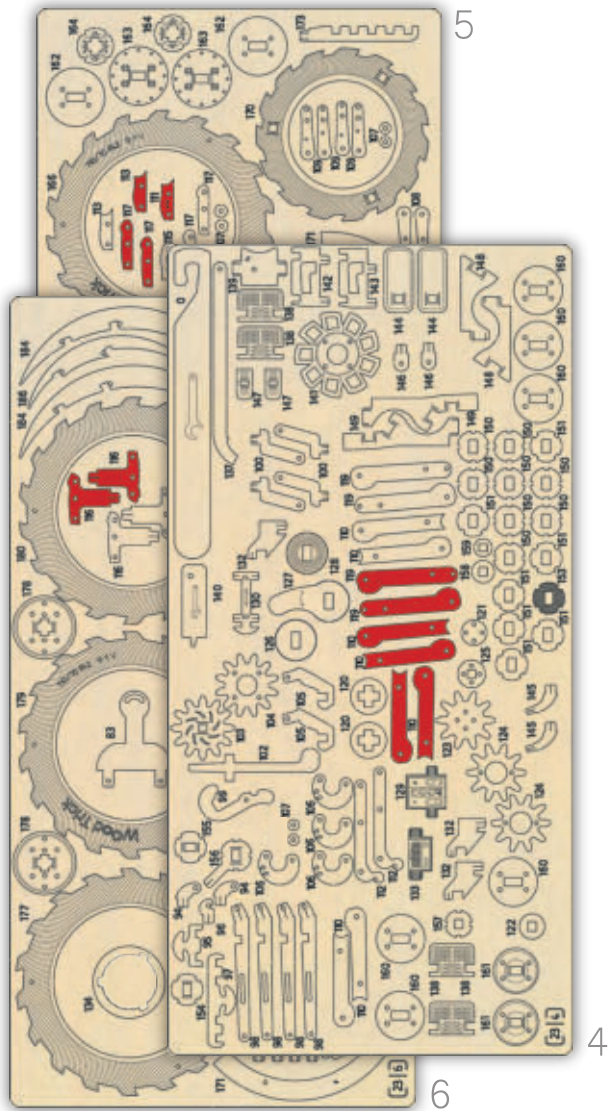

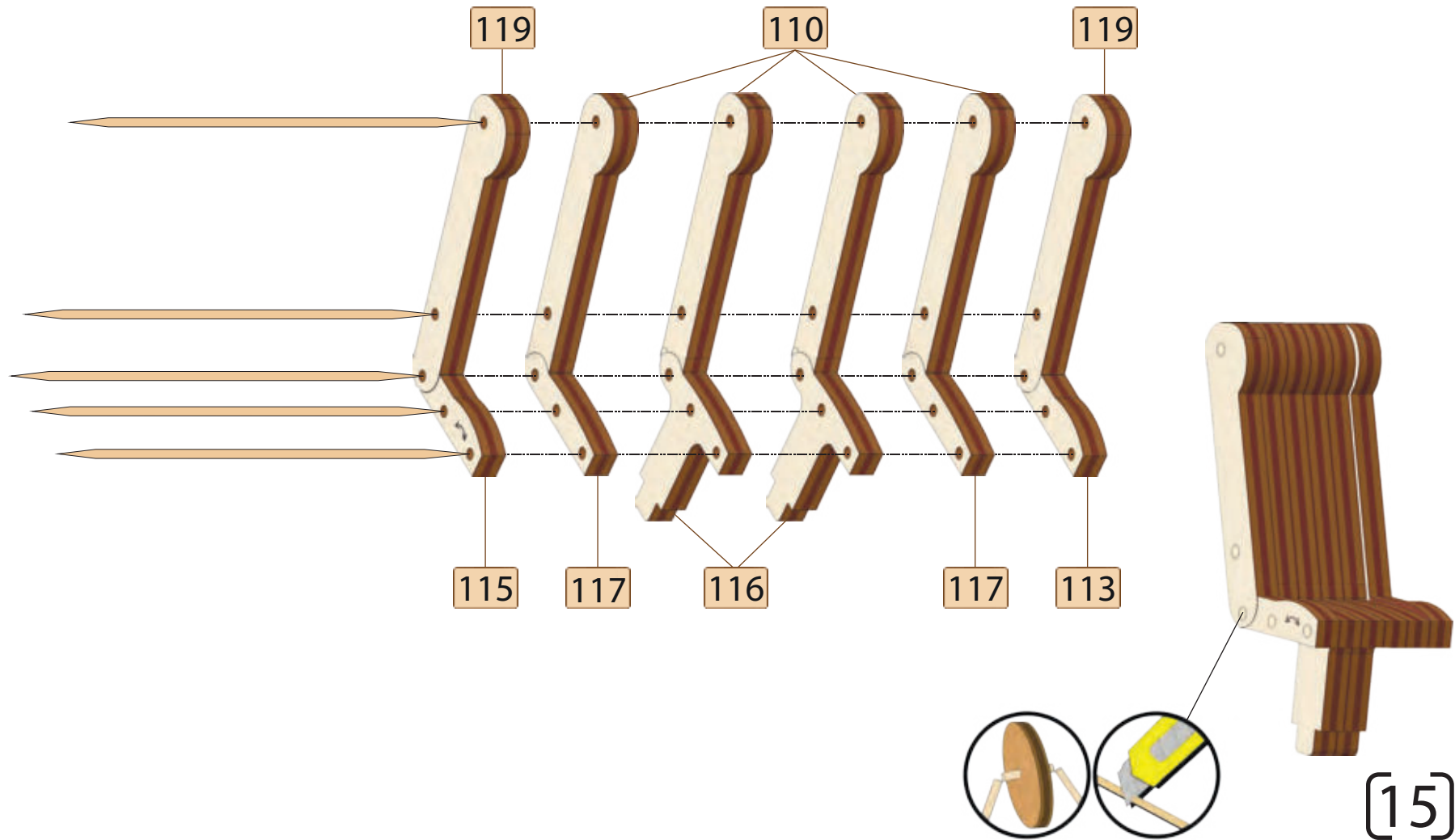
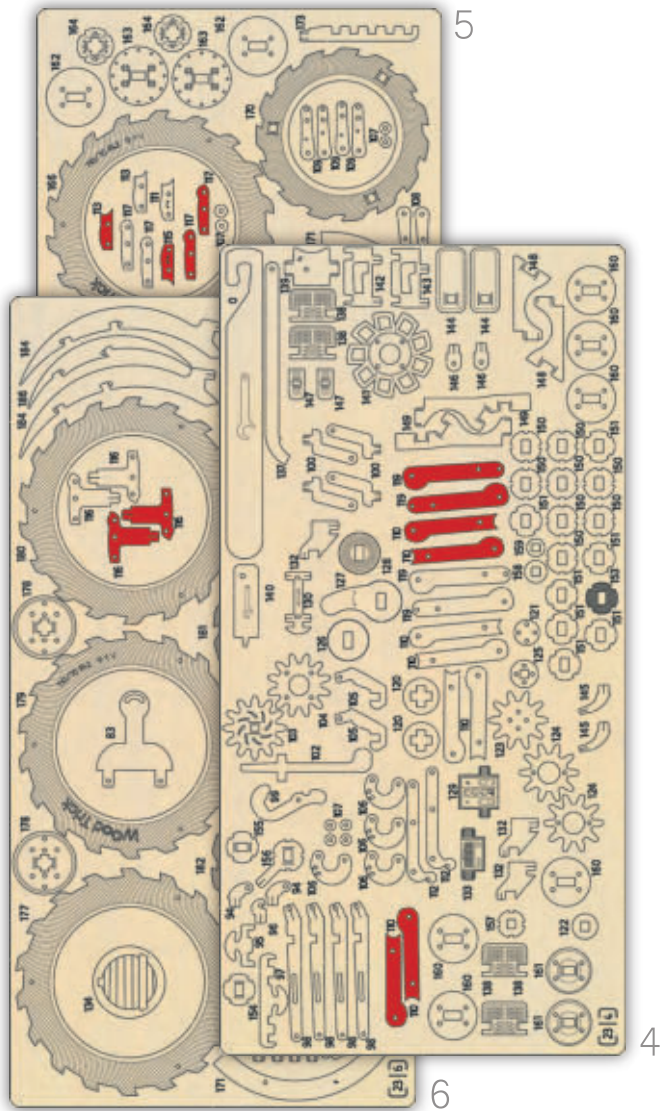



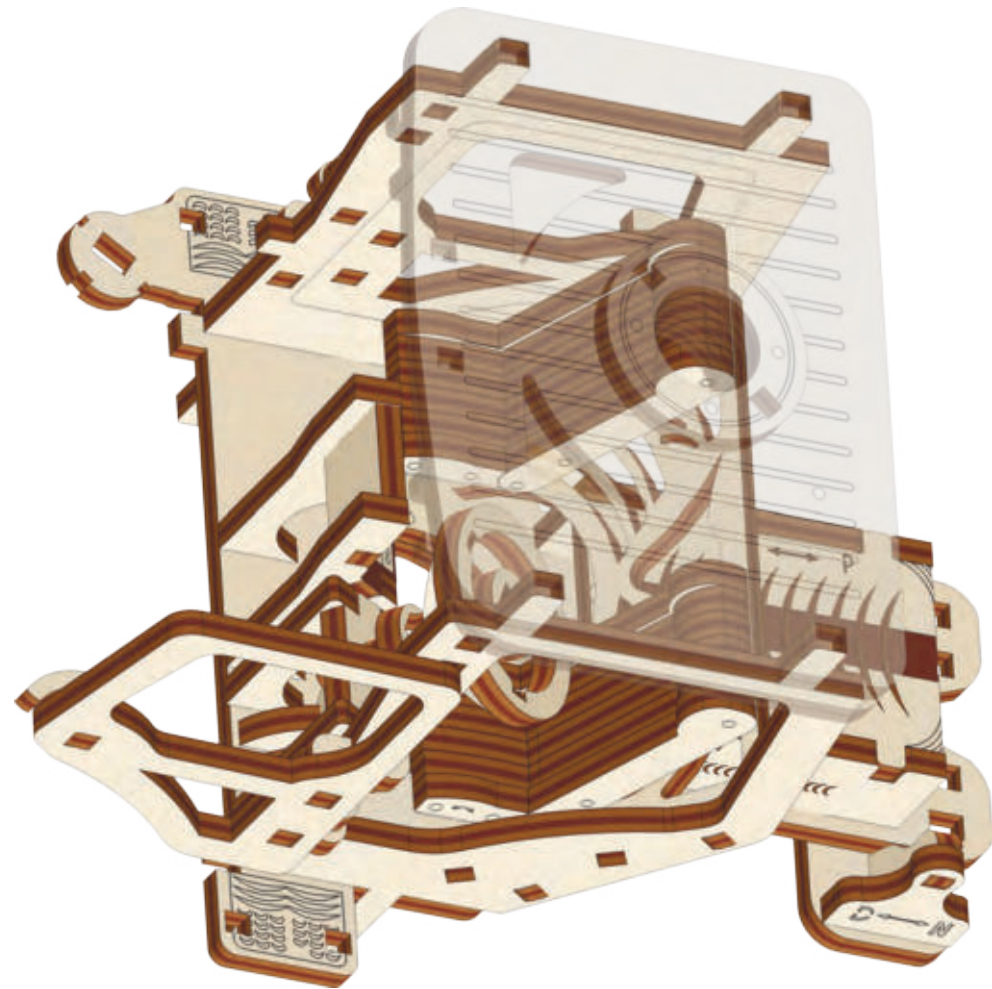
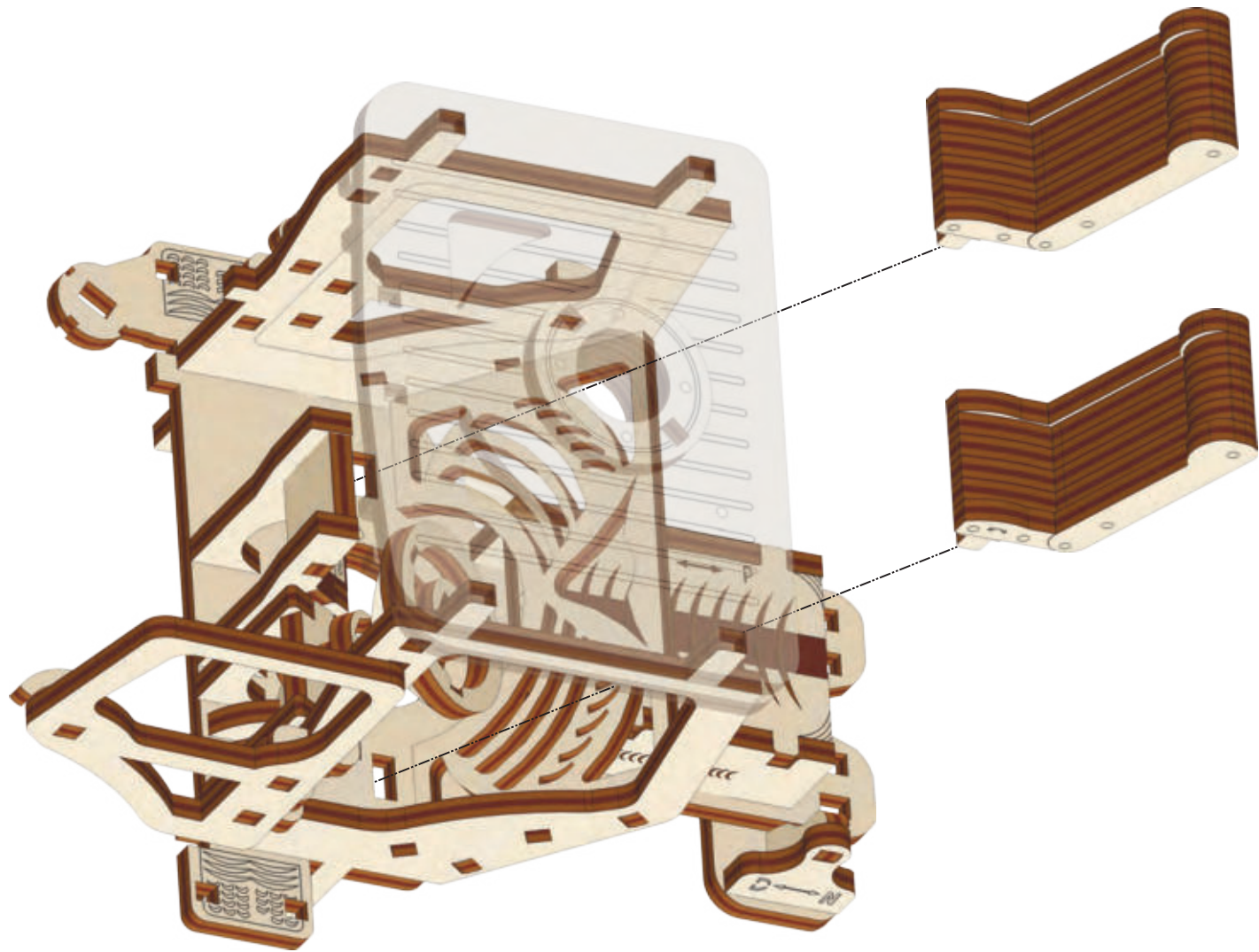

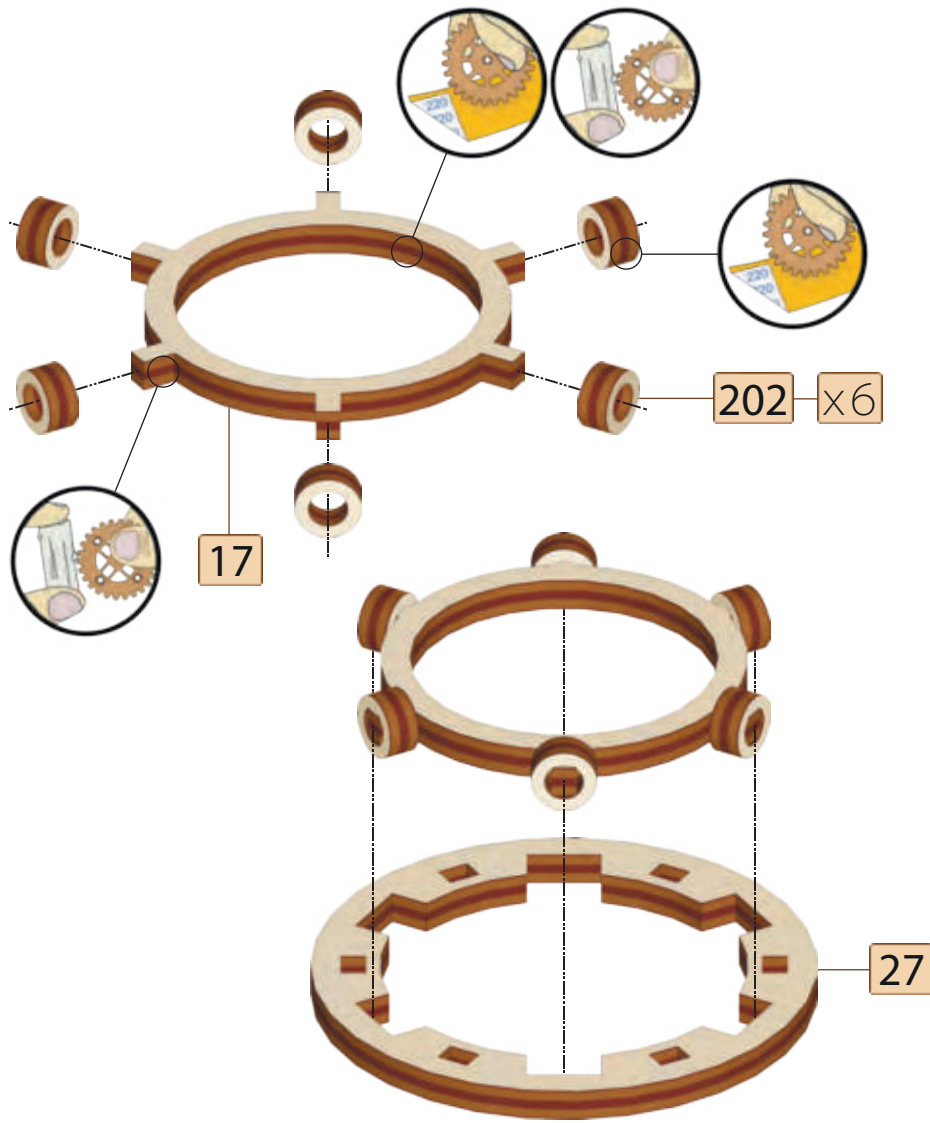
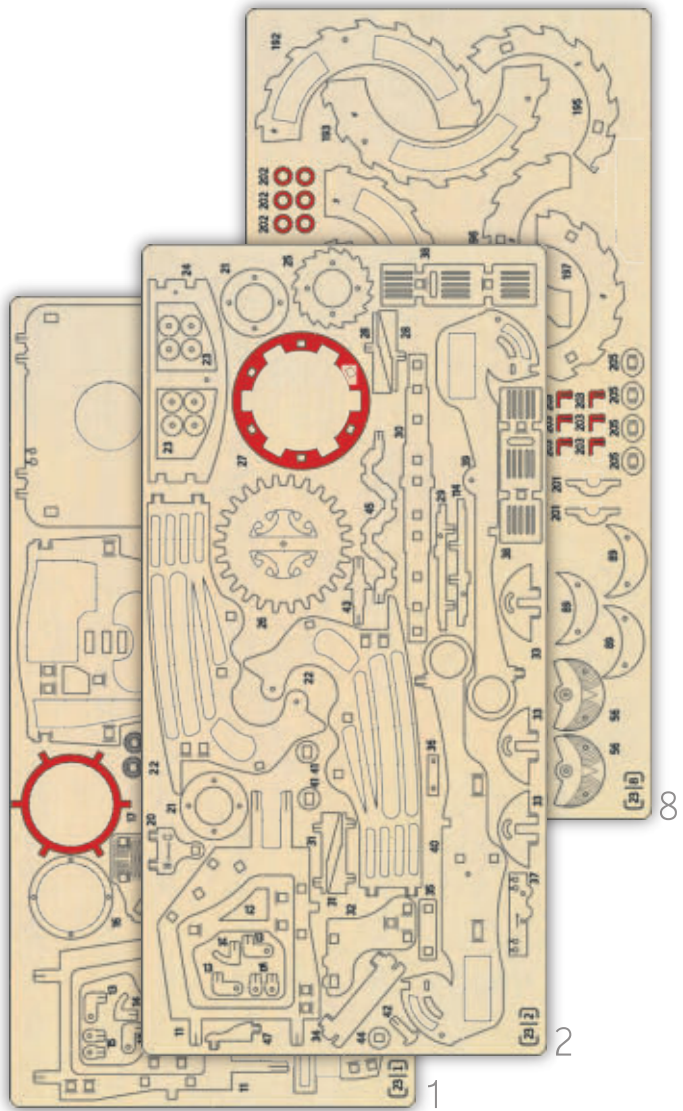

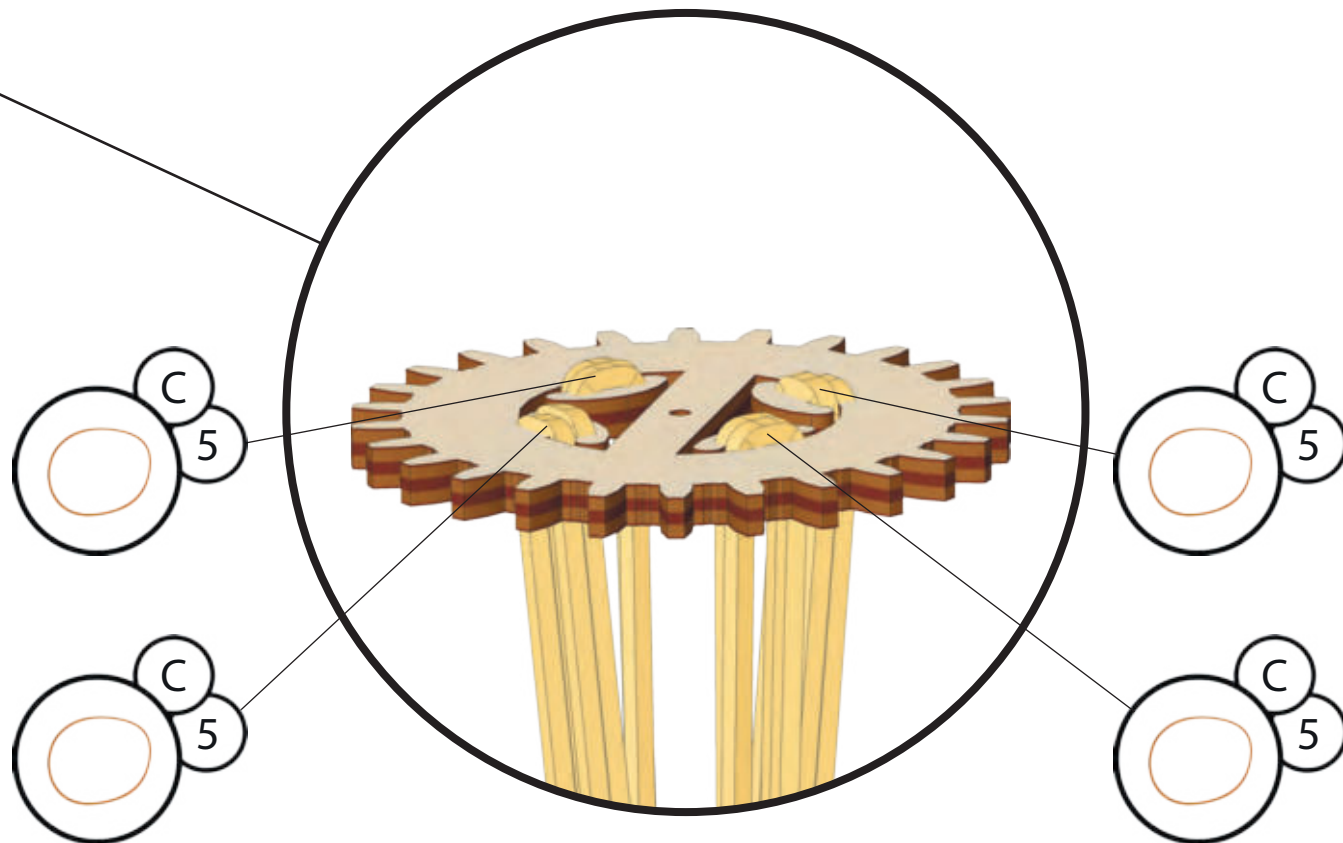
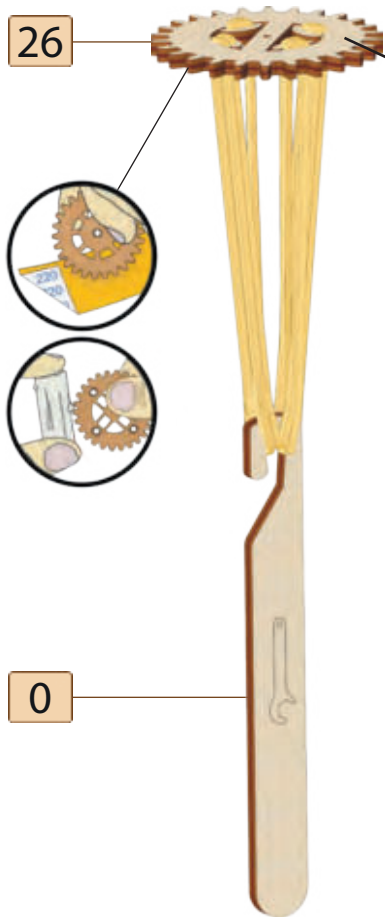

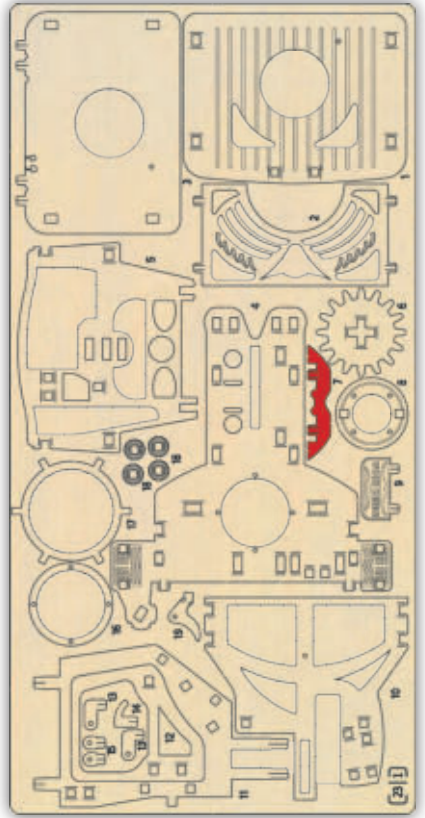

1

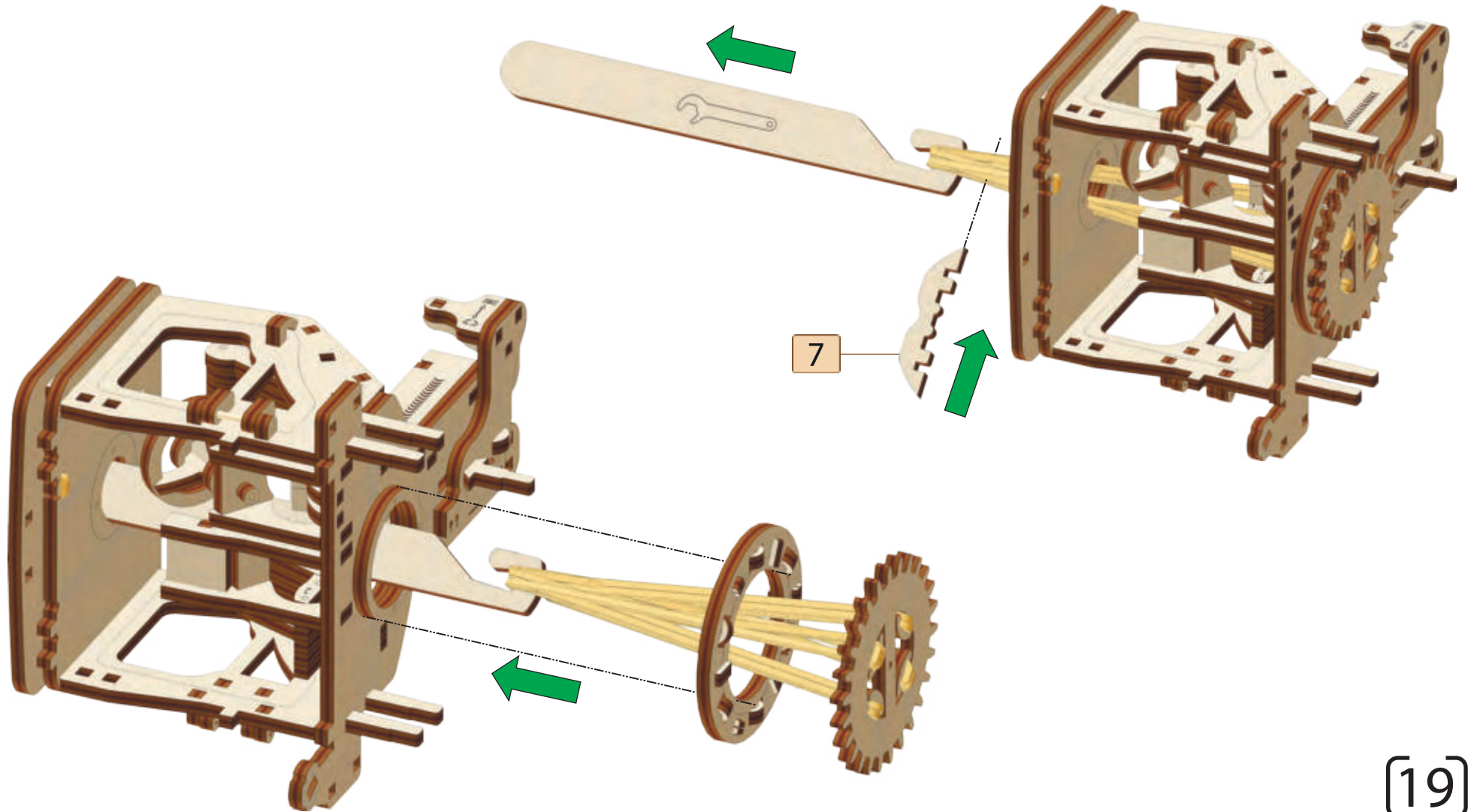

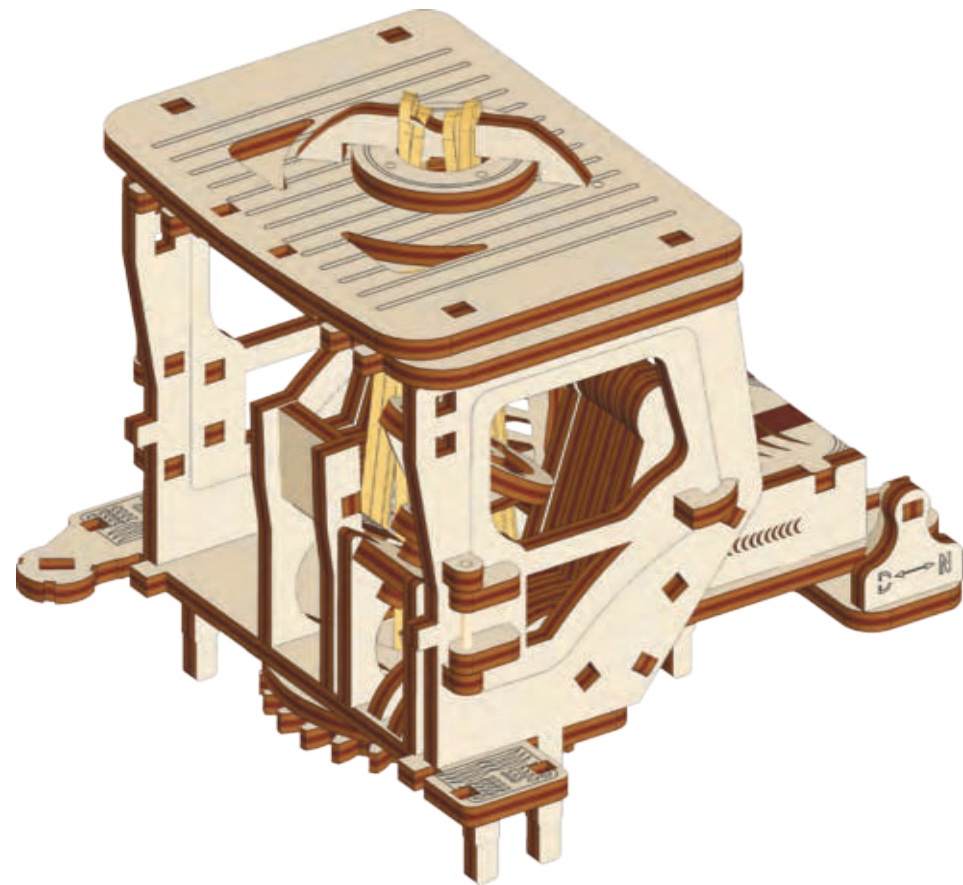
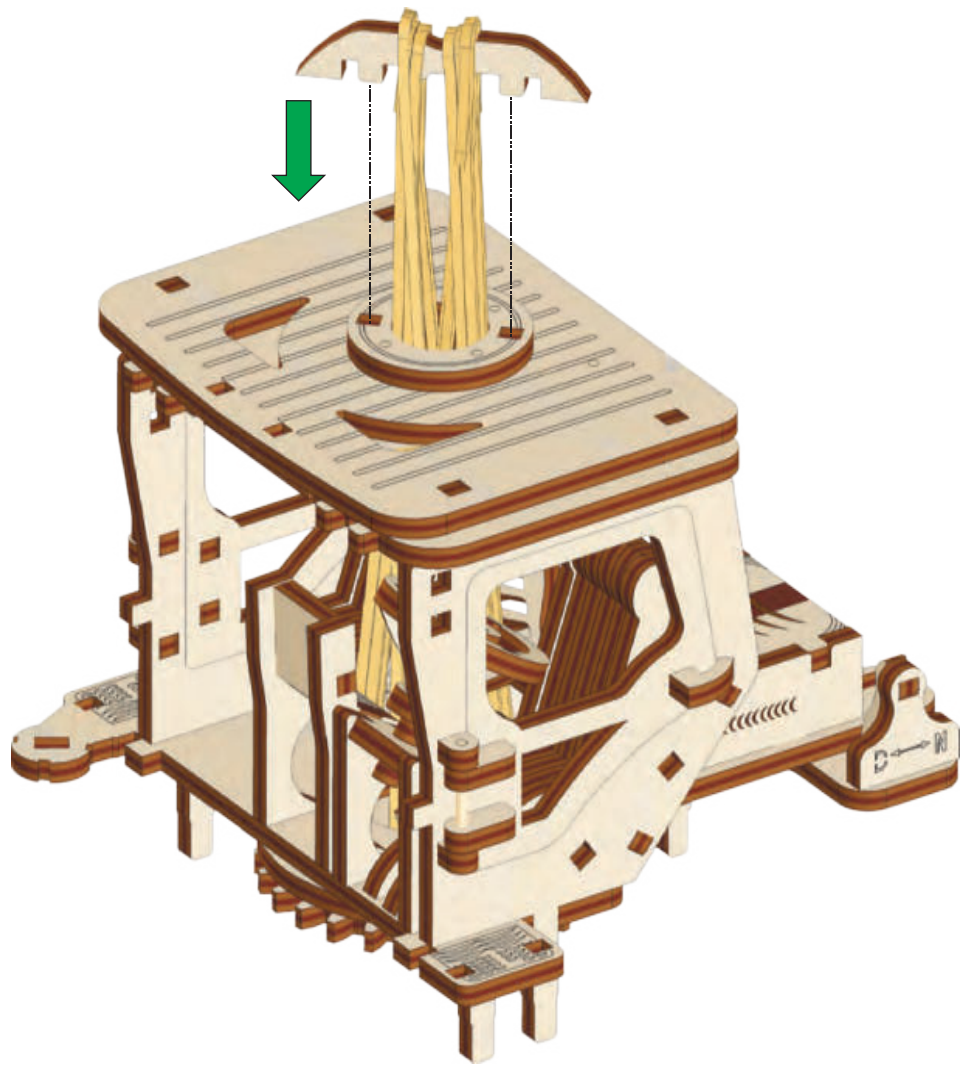

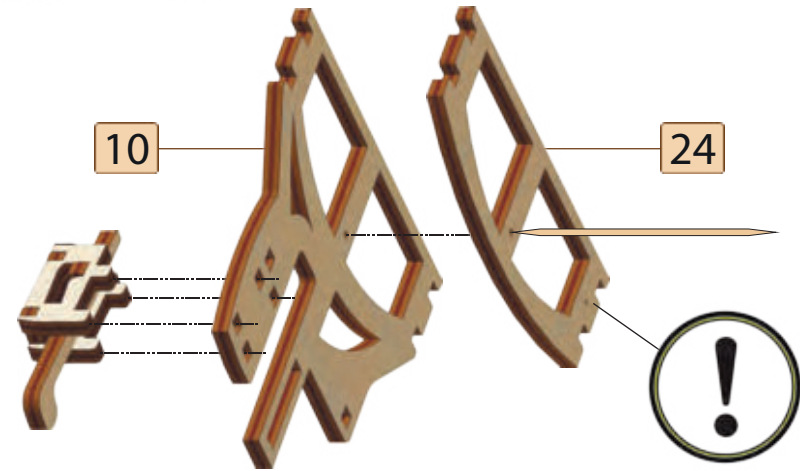
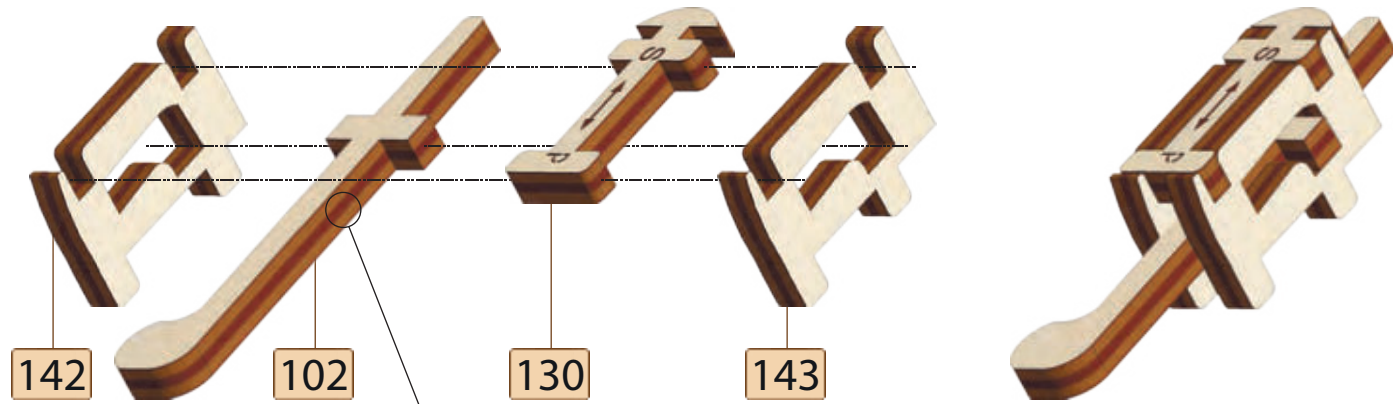
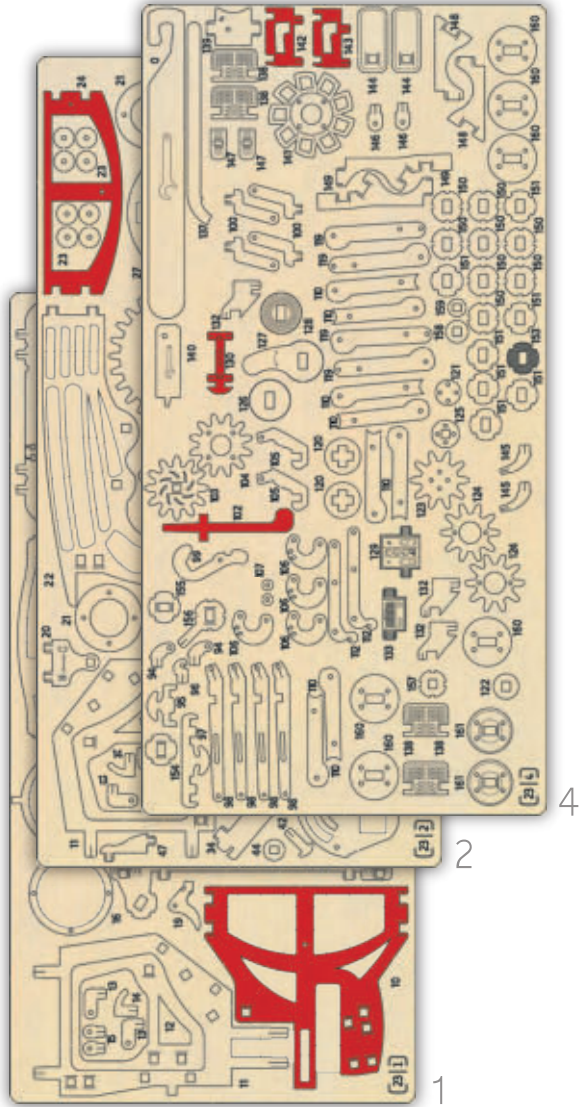

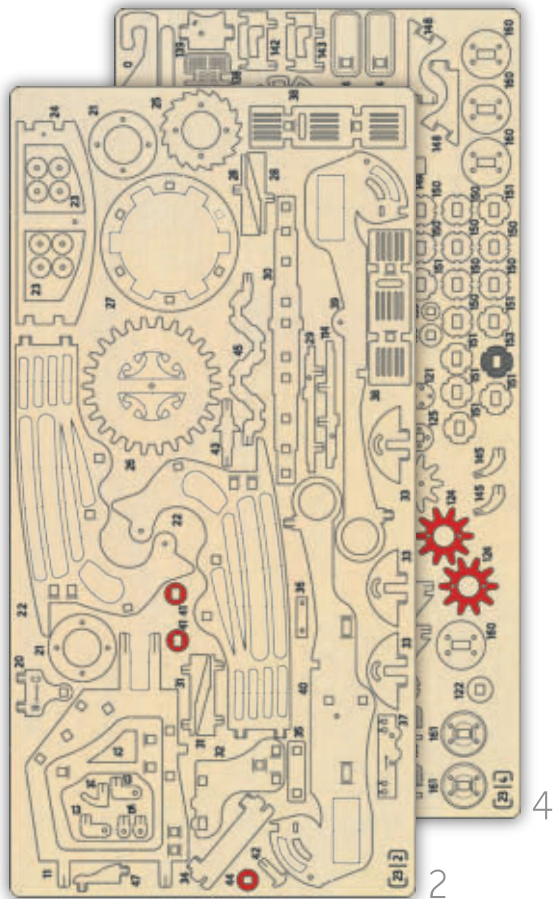

4



124

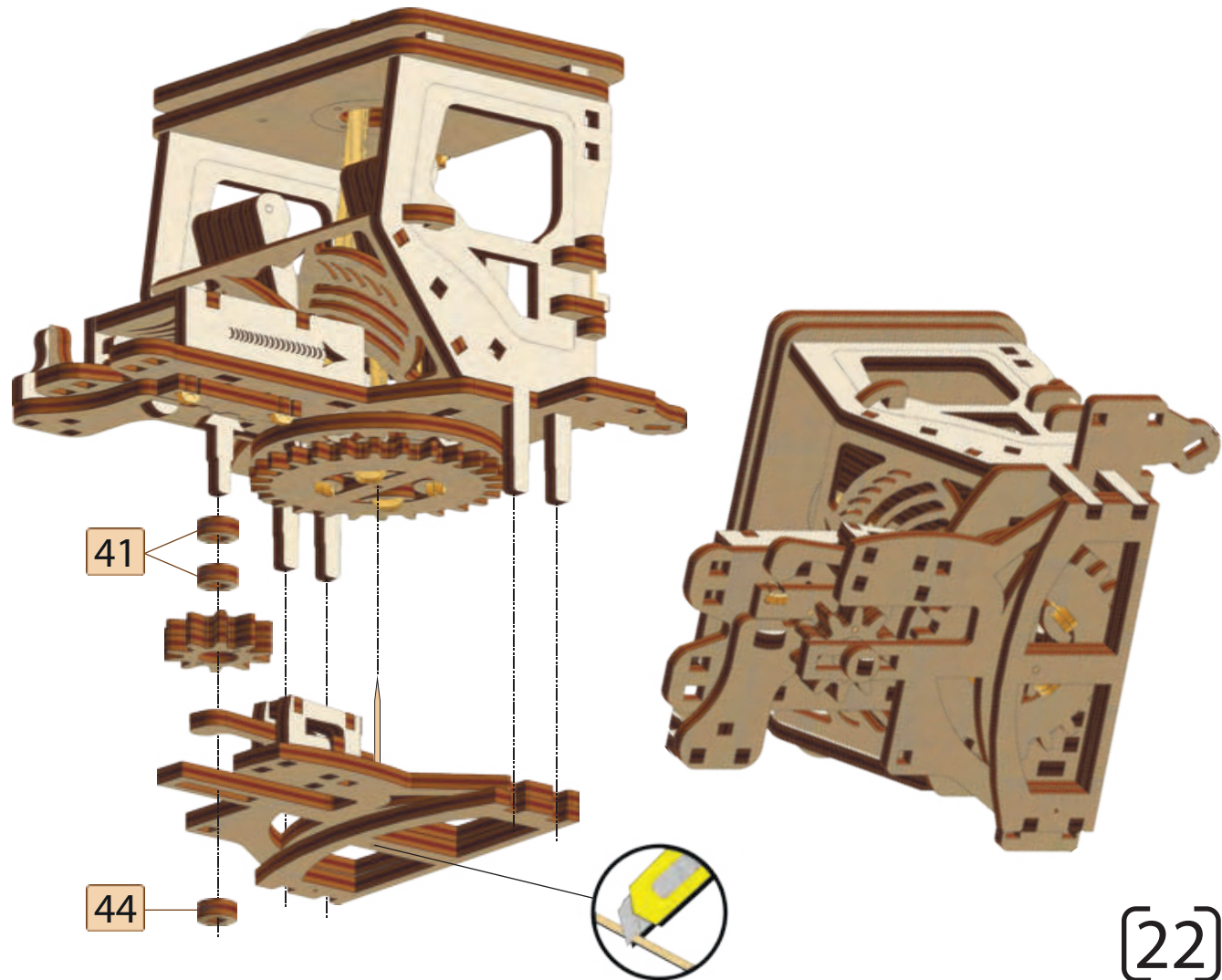
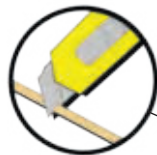
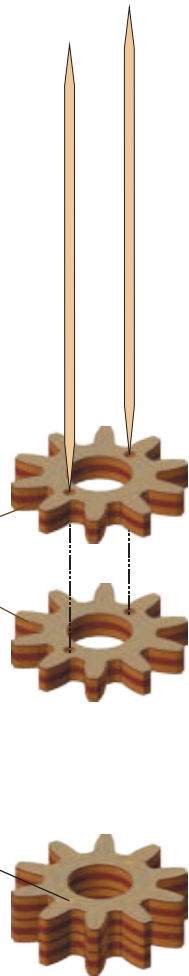

22

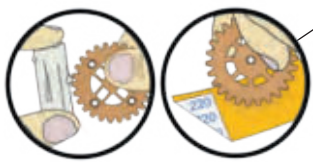
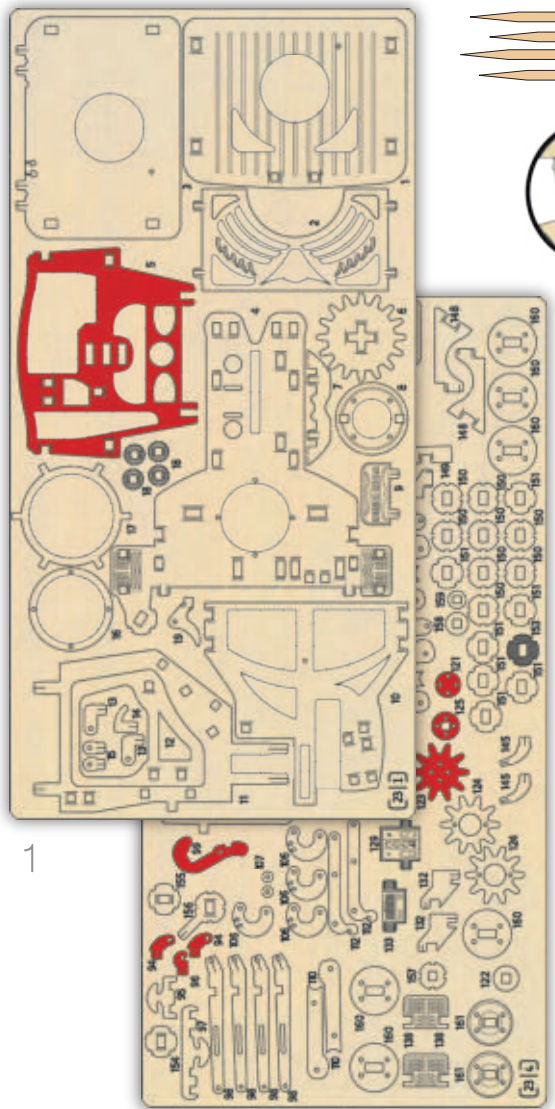

121

125

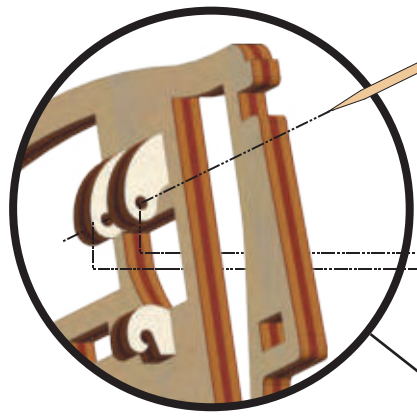
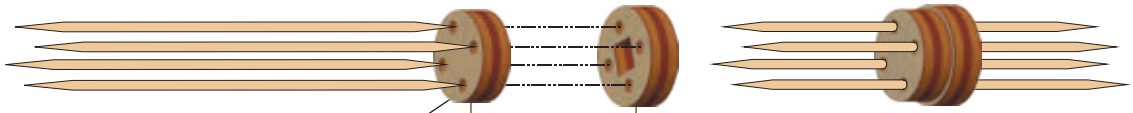

99



94

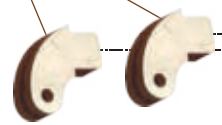

5

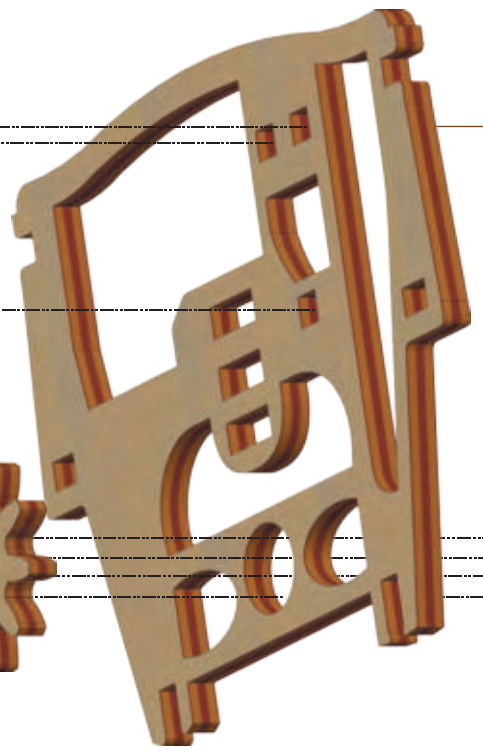

96

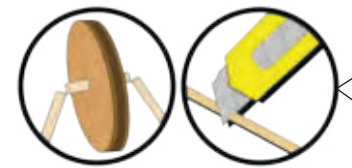

123

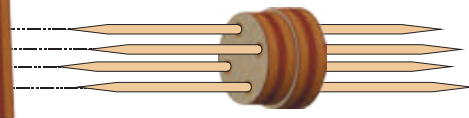
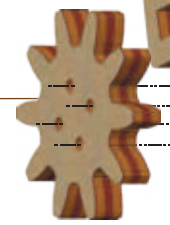

[23]



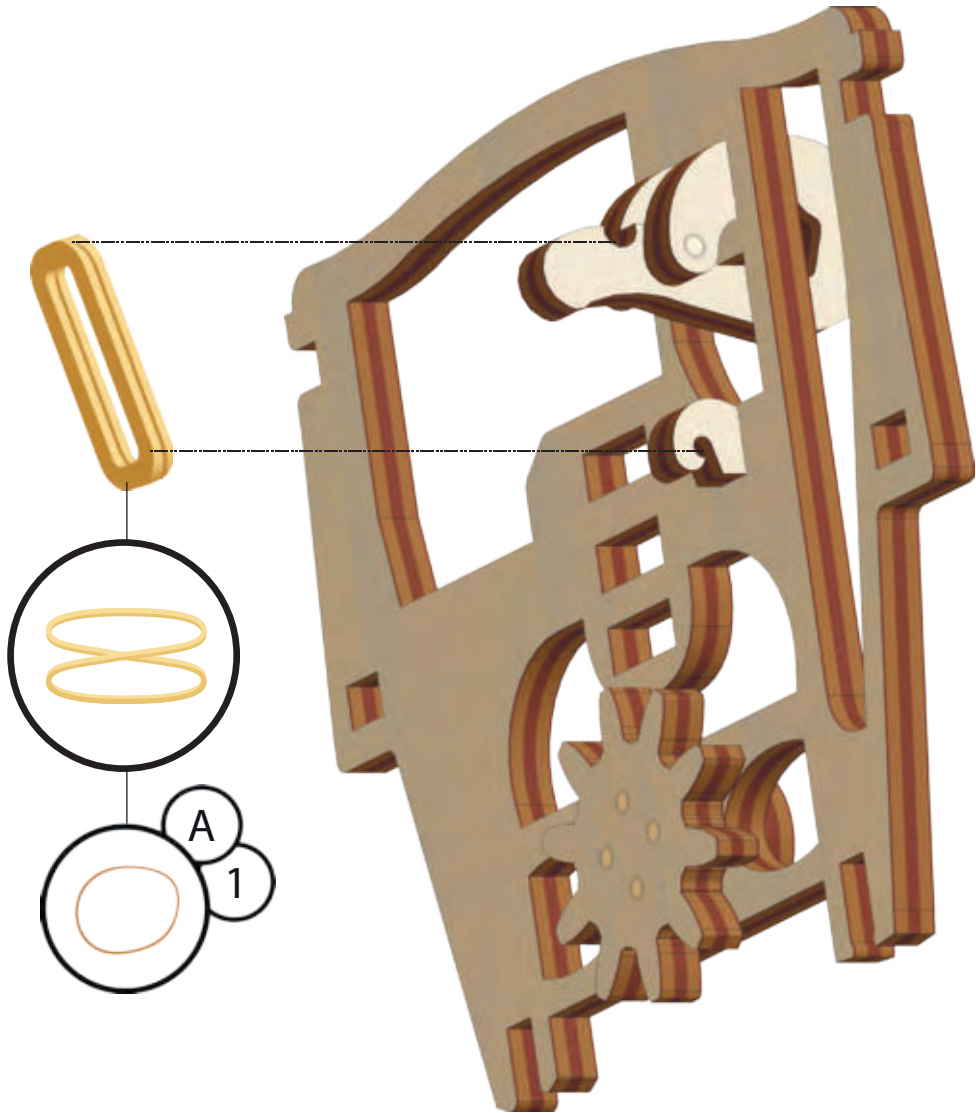

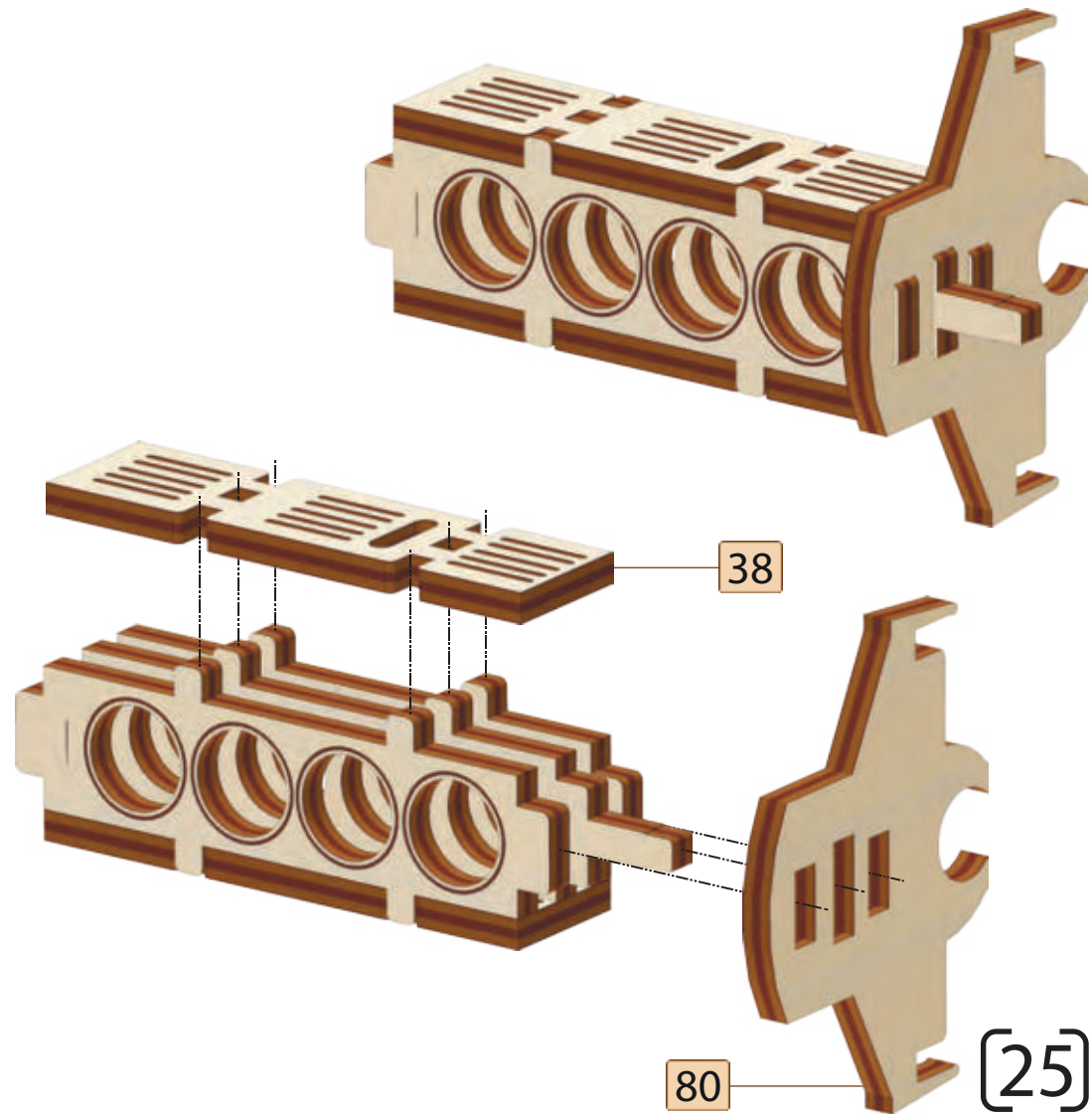
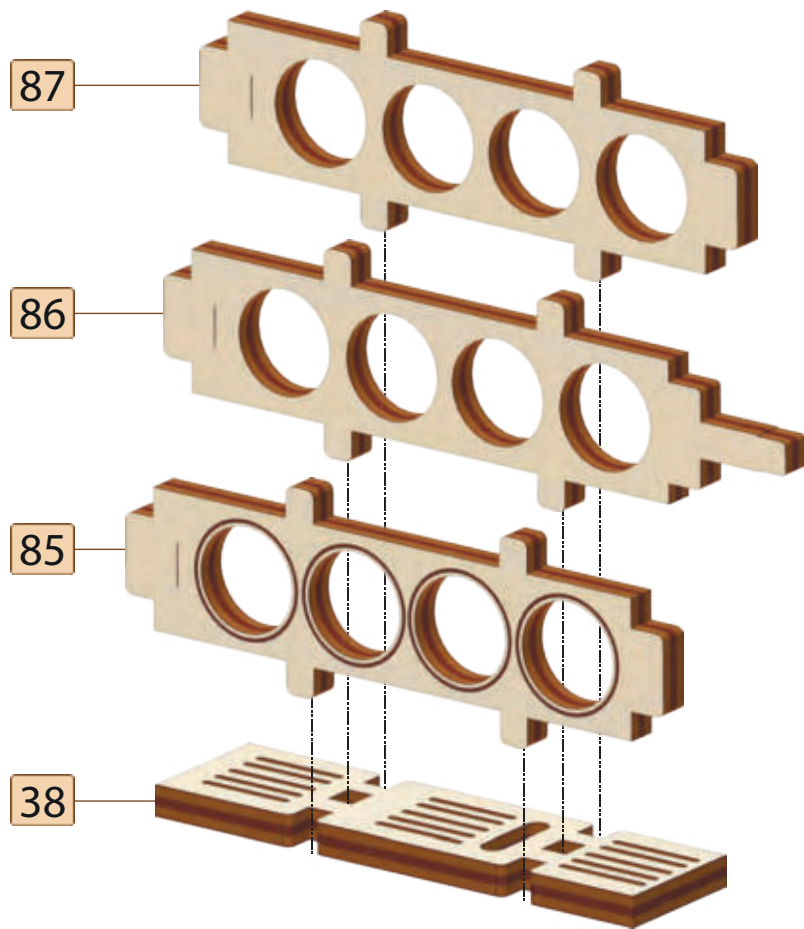
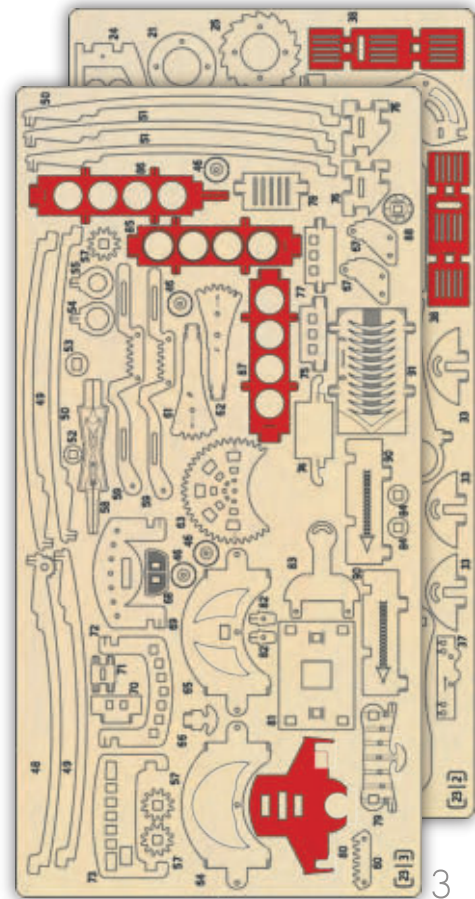

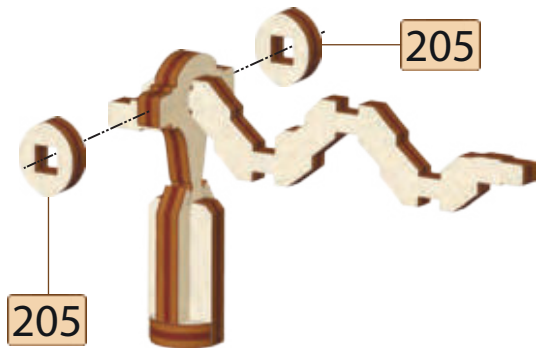
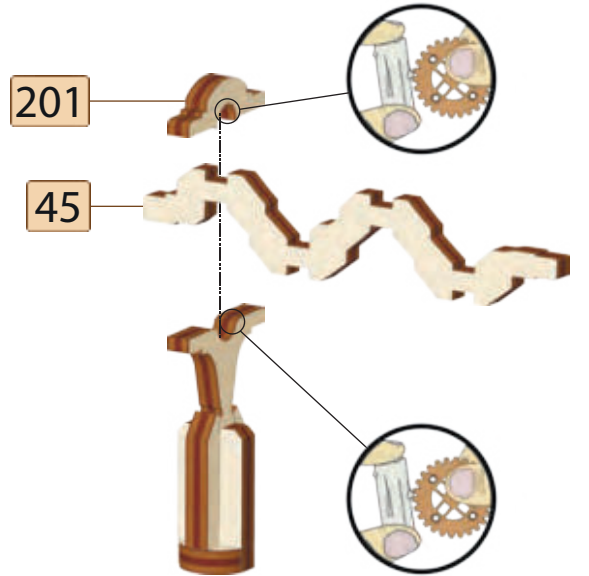
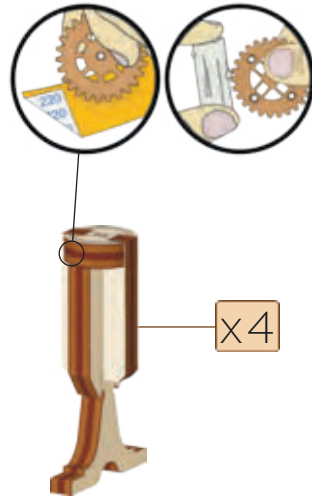
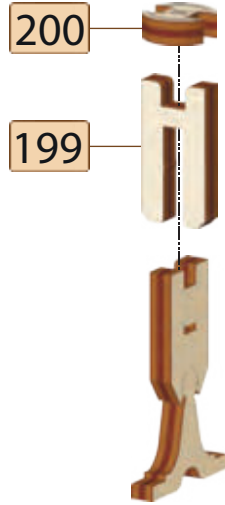
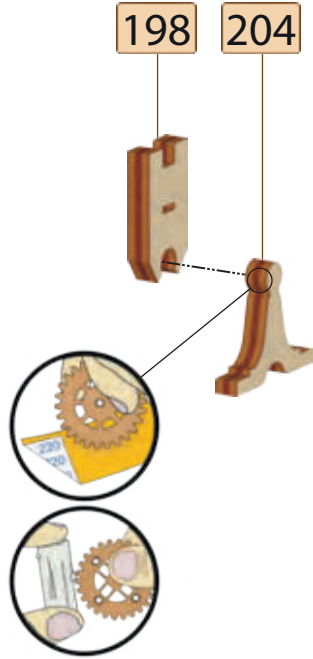
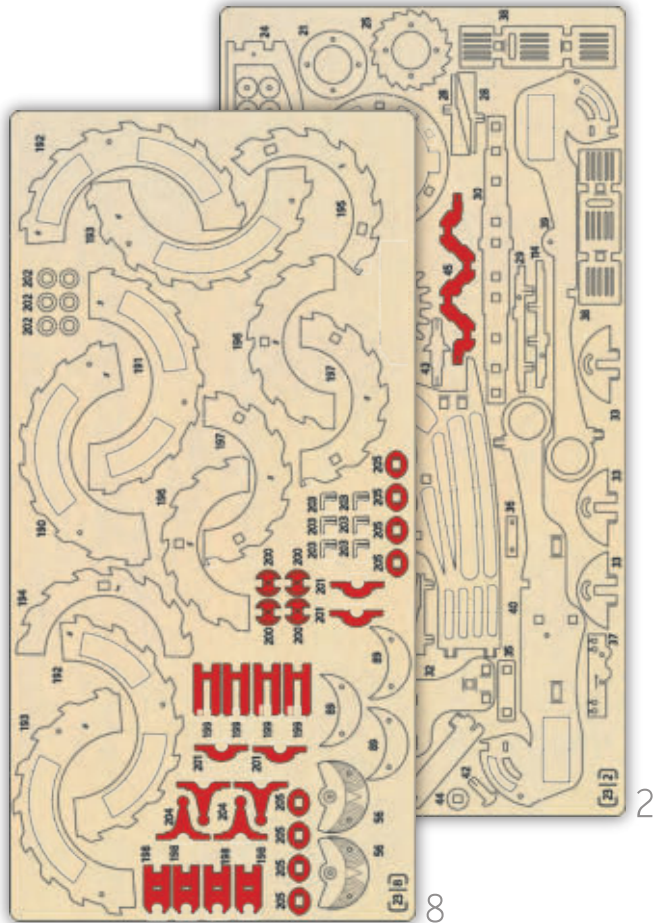

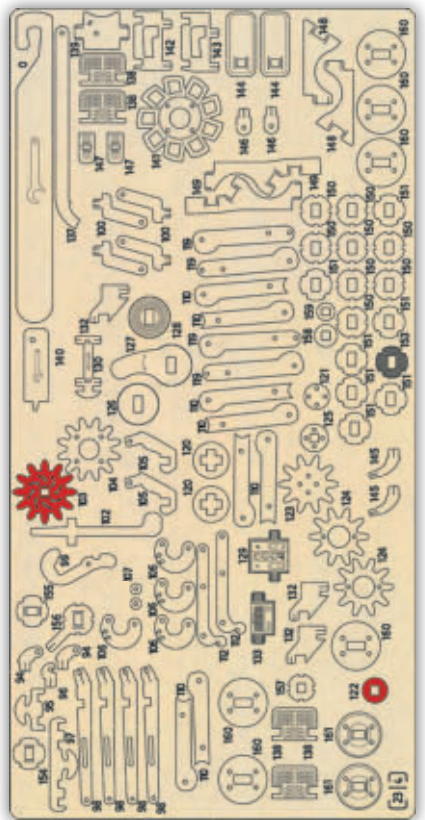

4

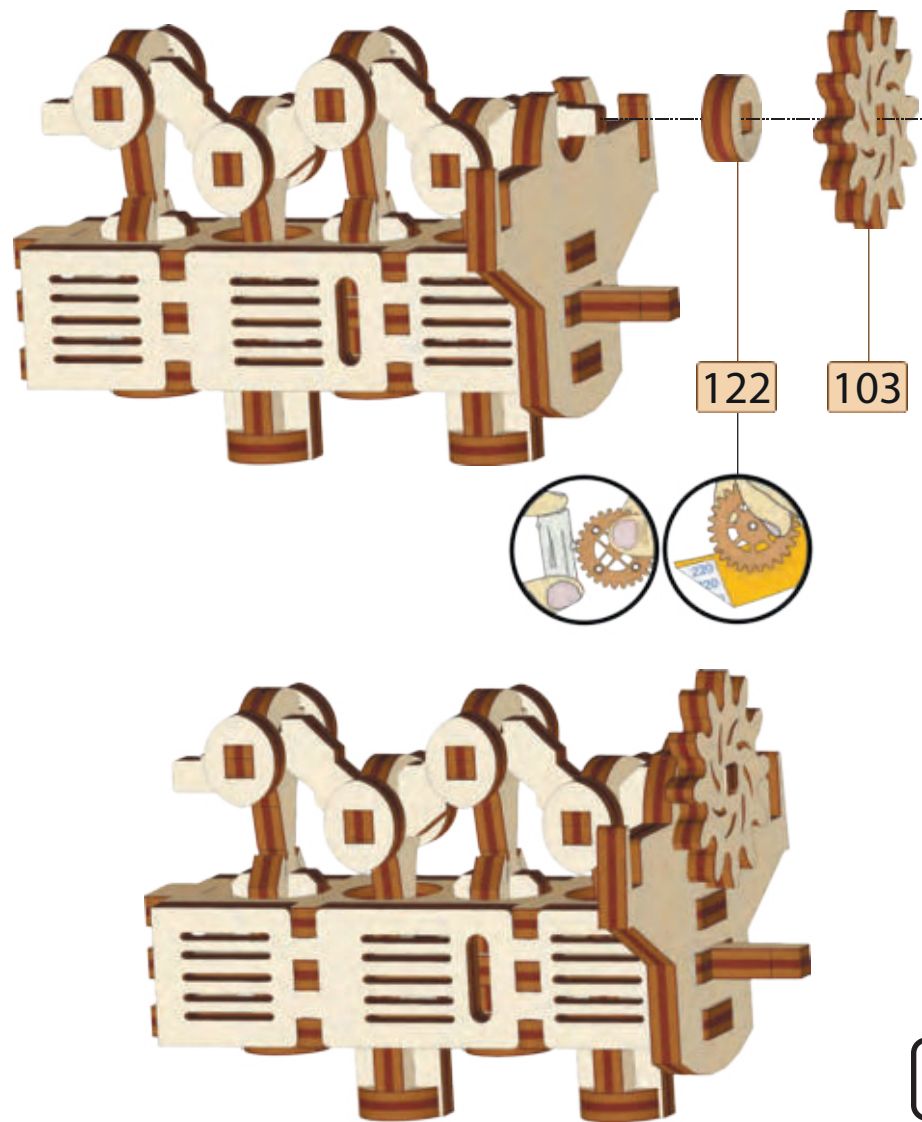
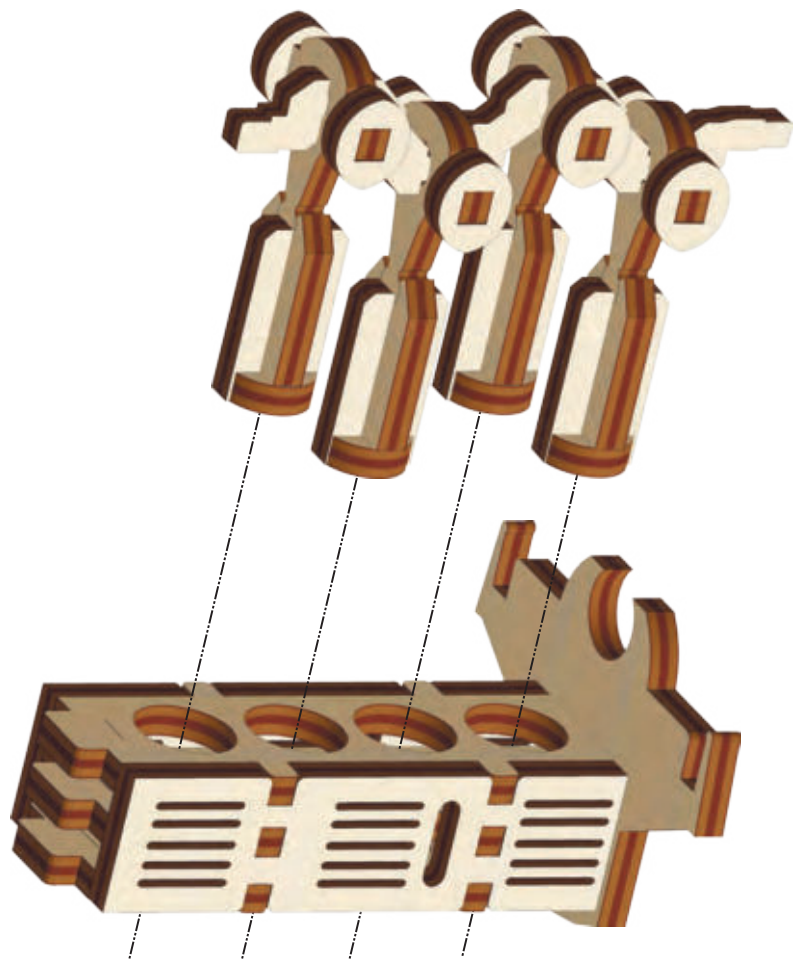

[27]

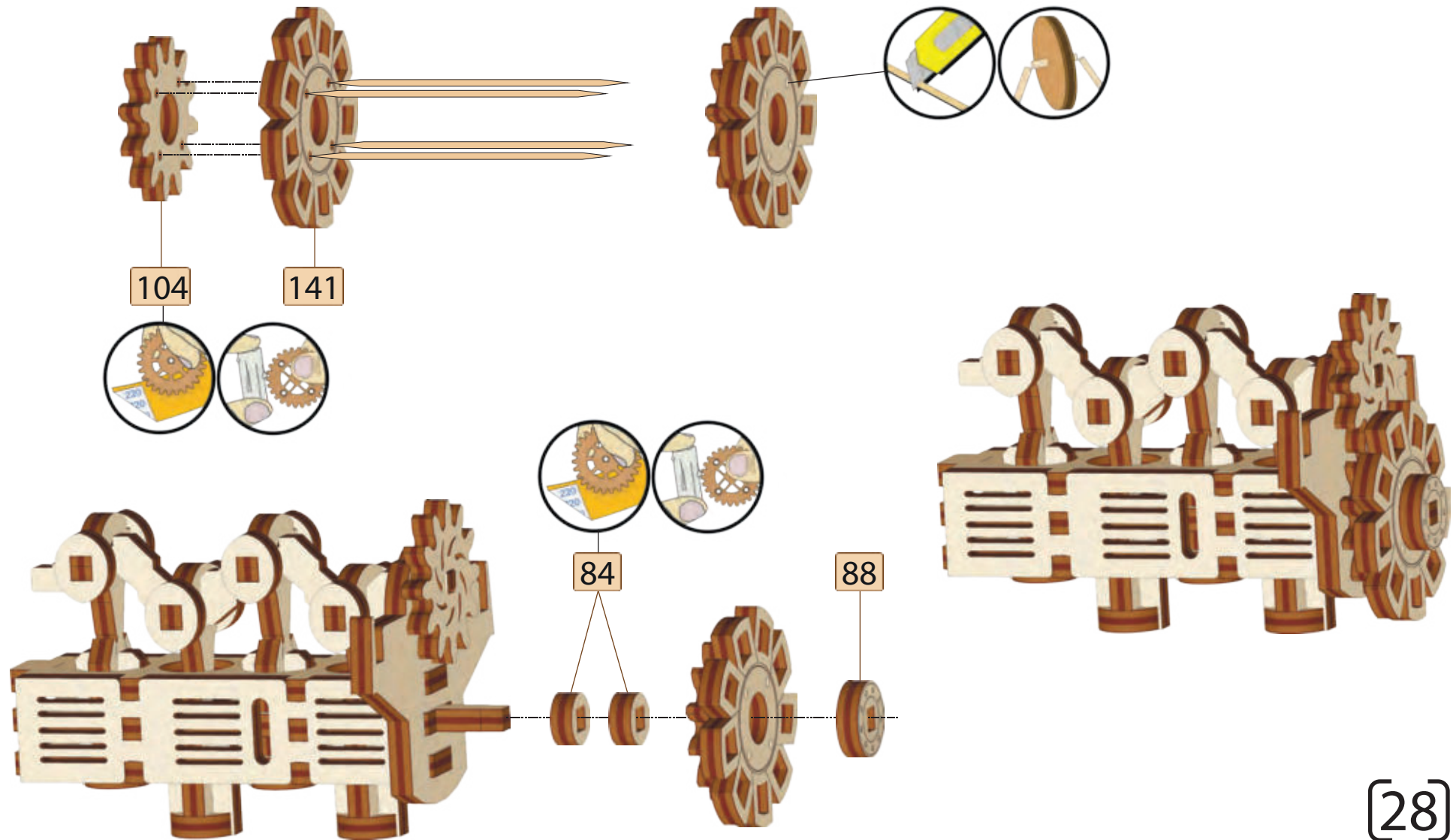
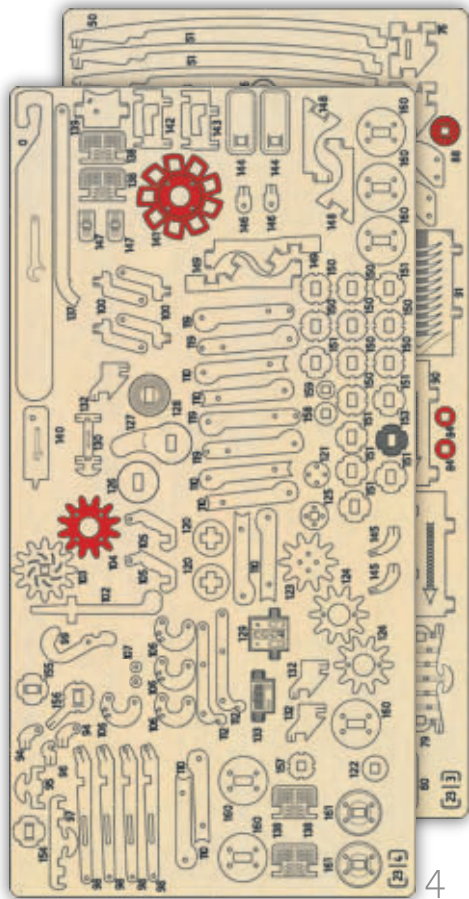

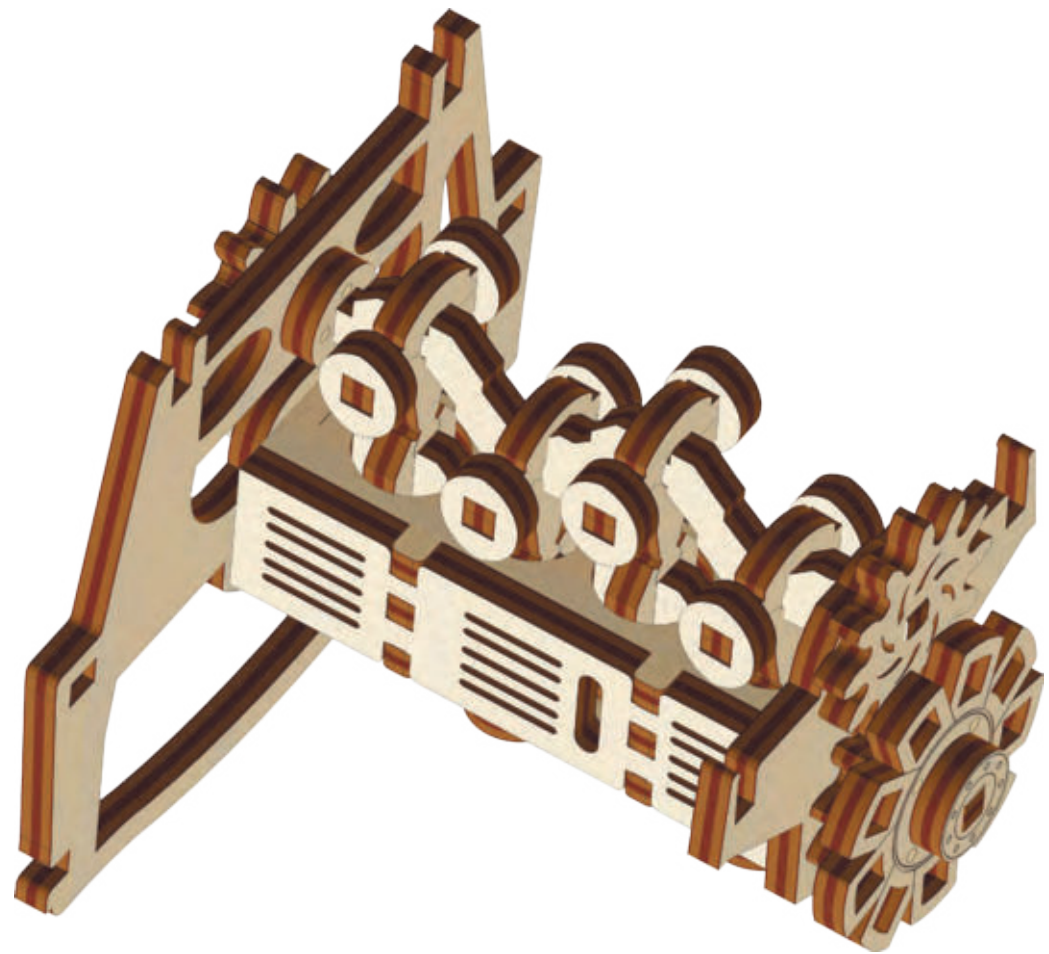
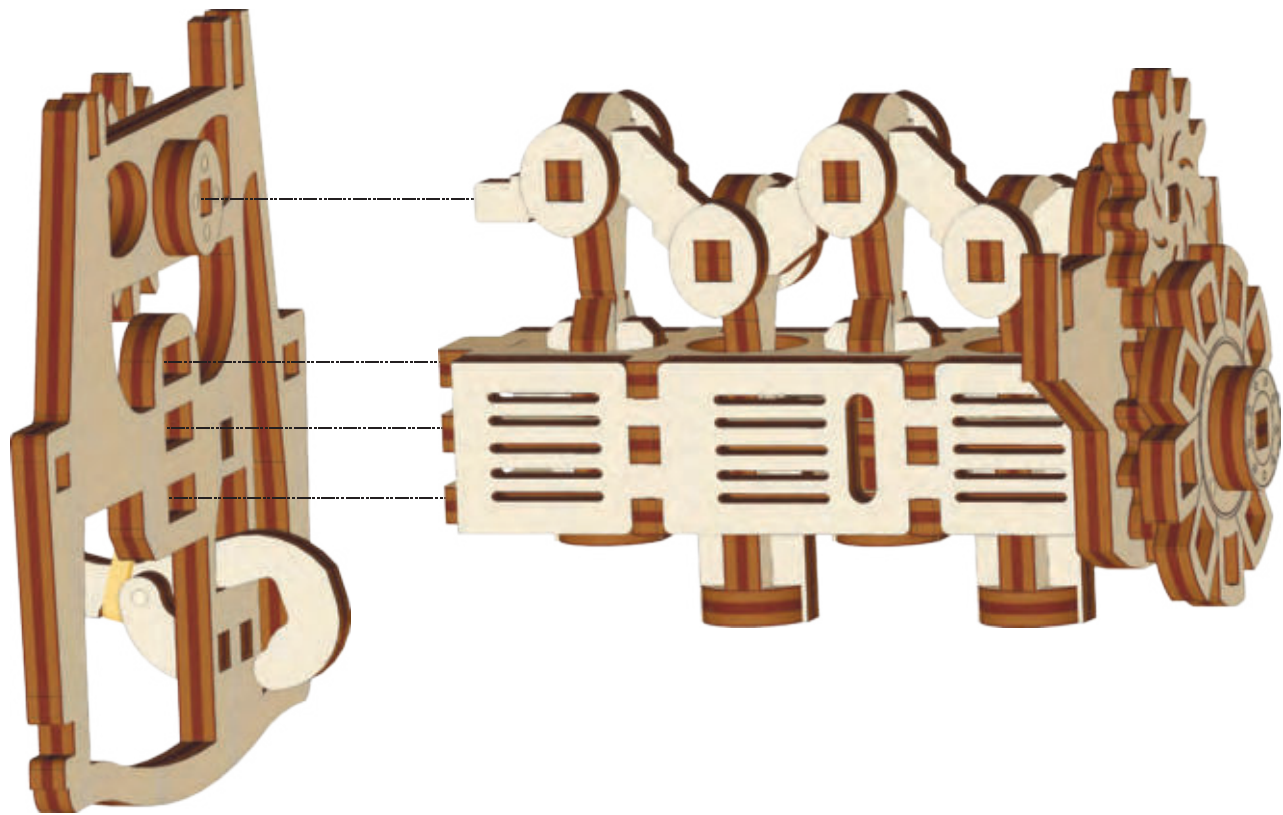

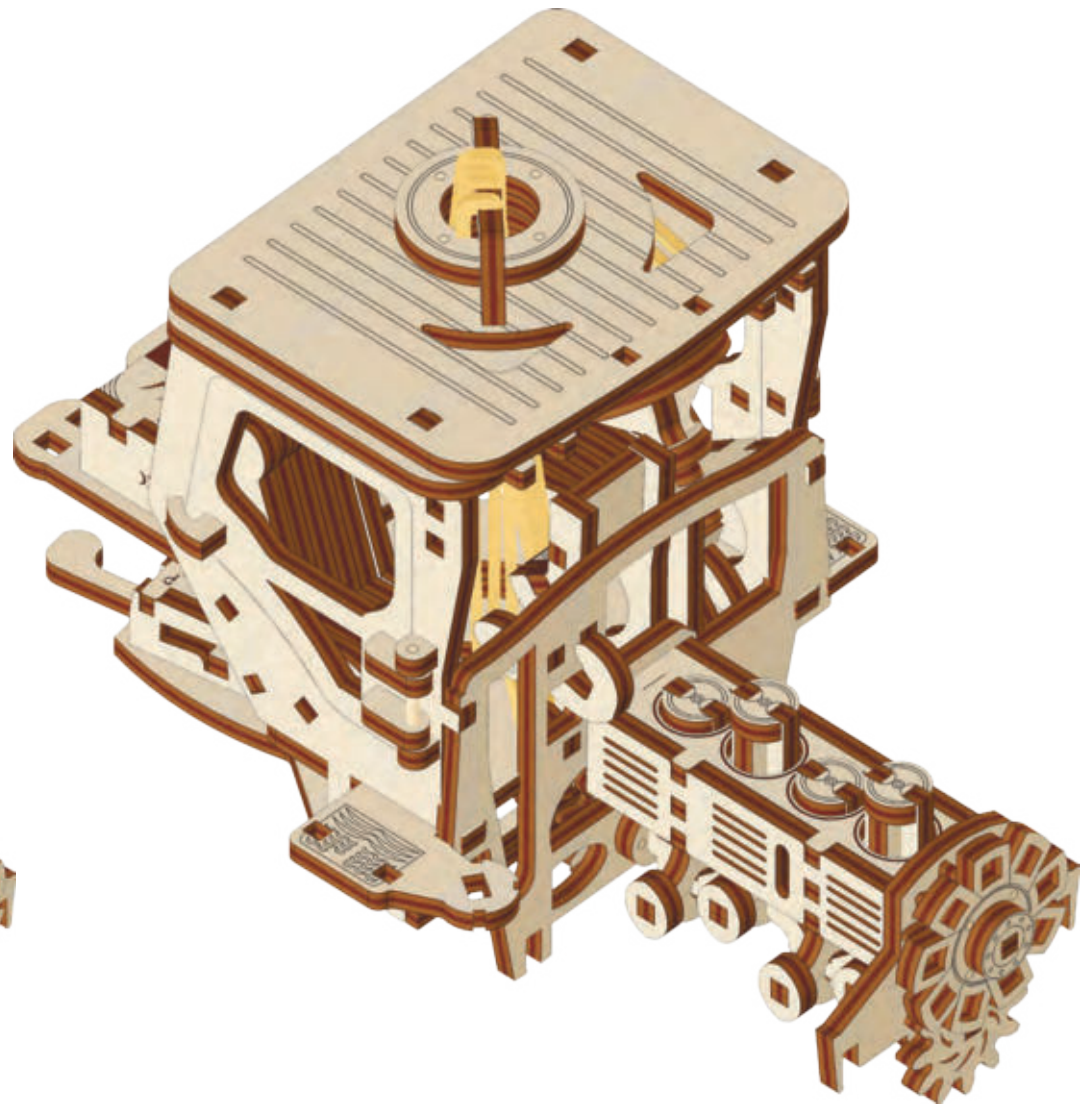
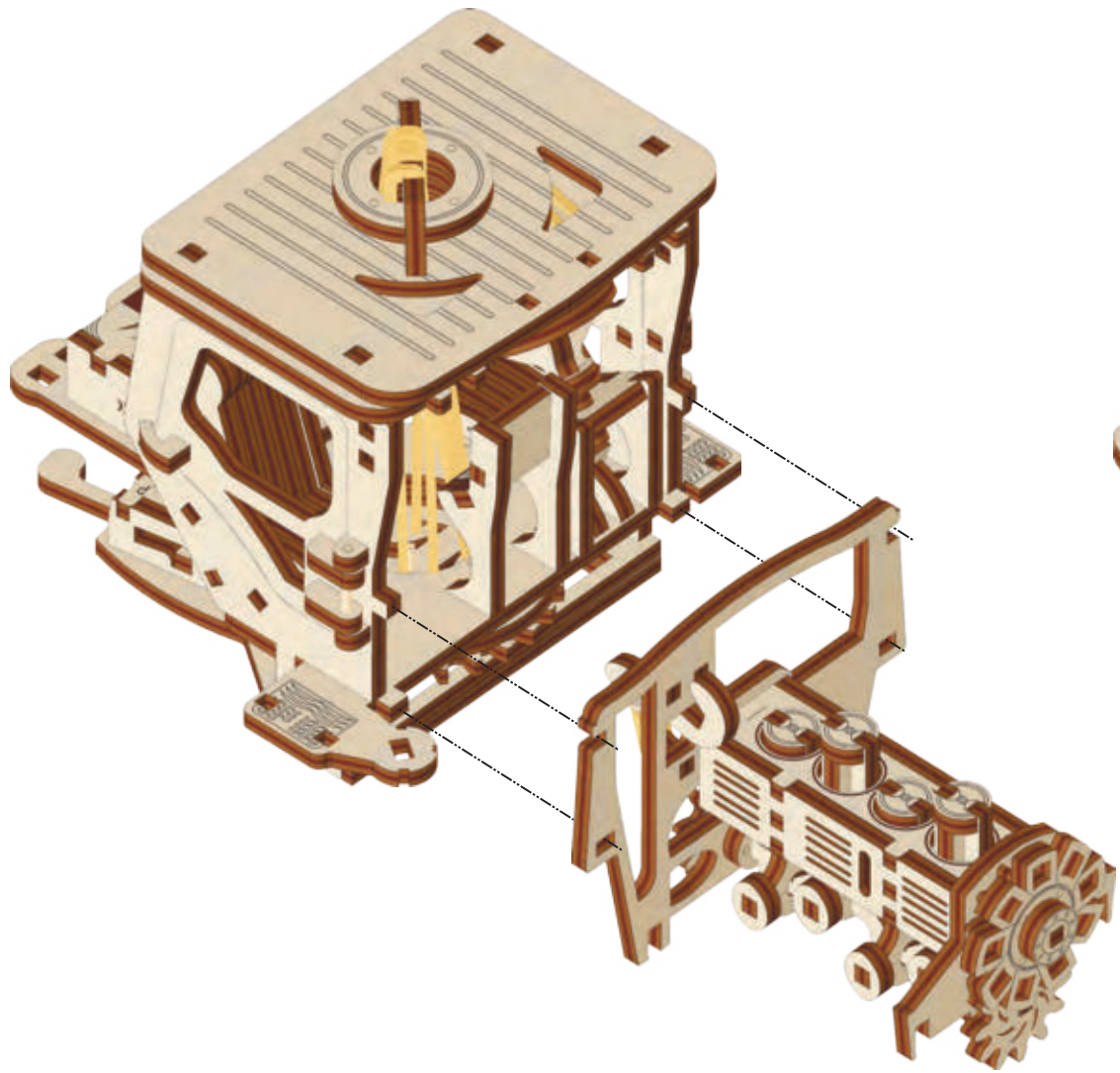

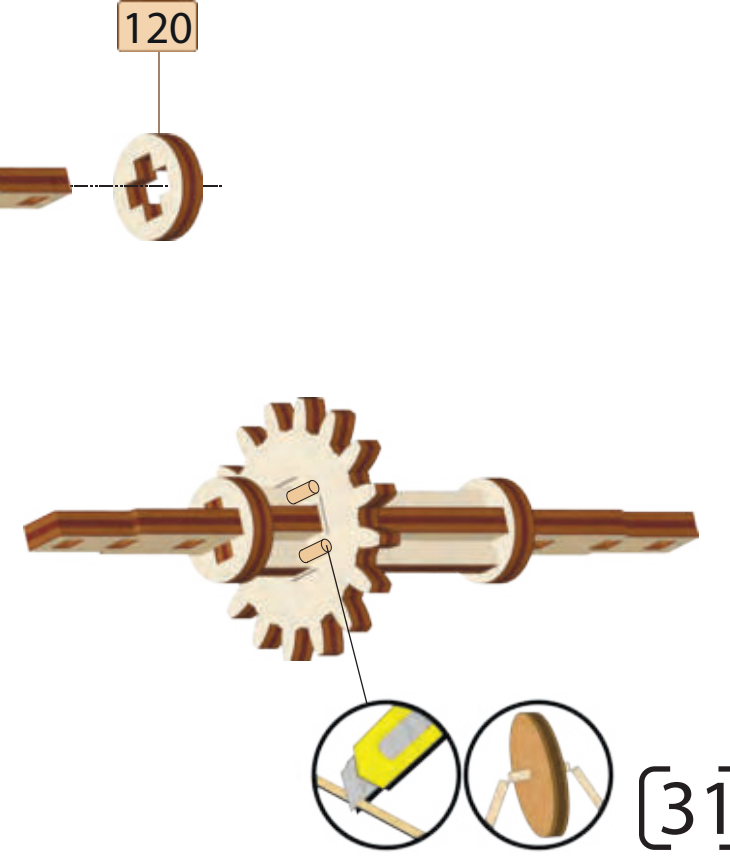
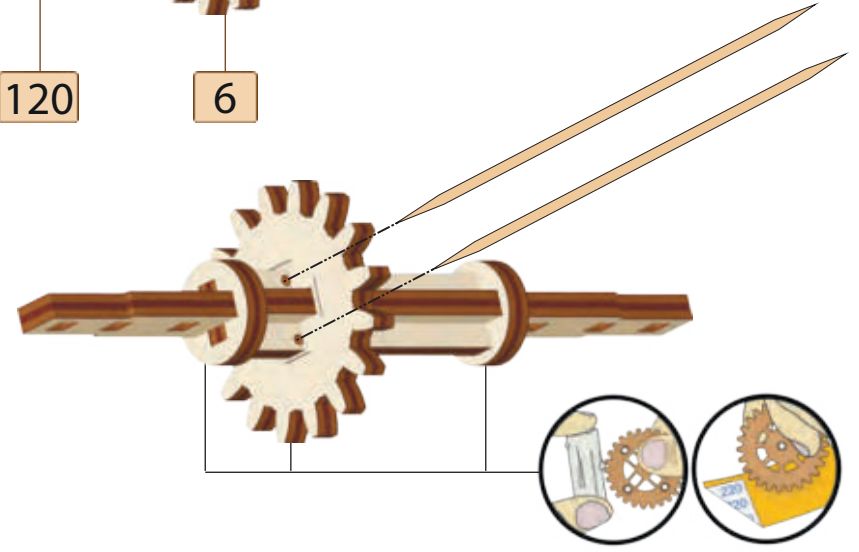
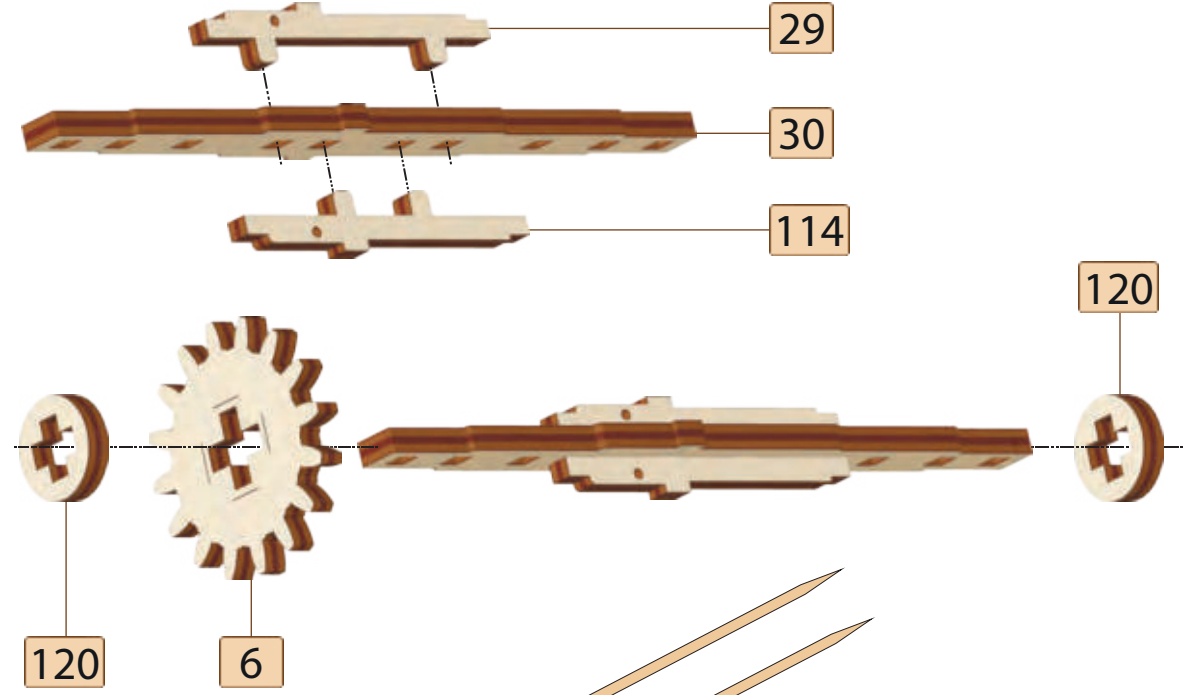
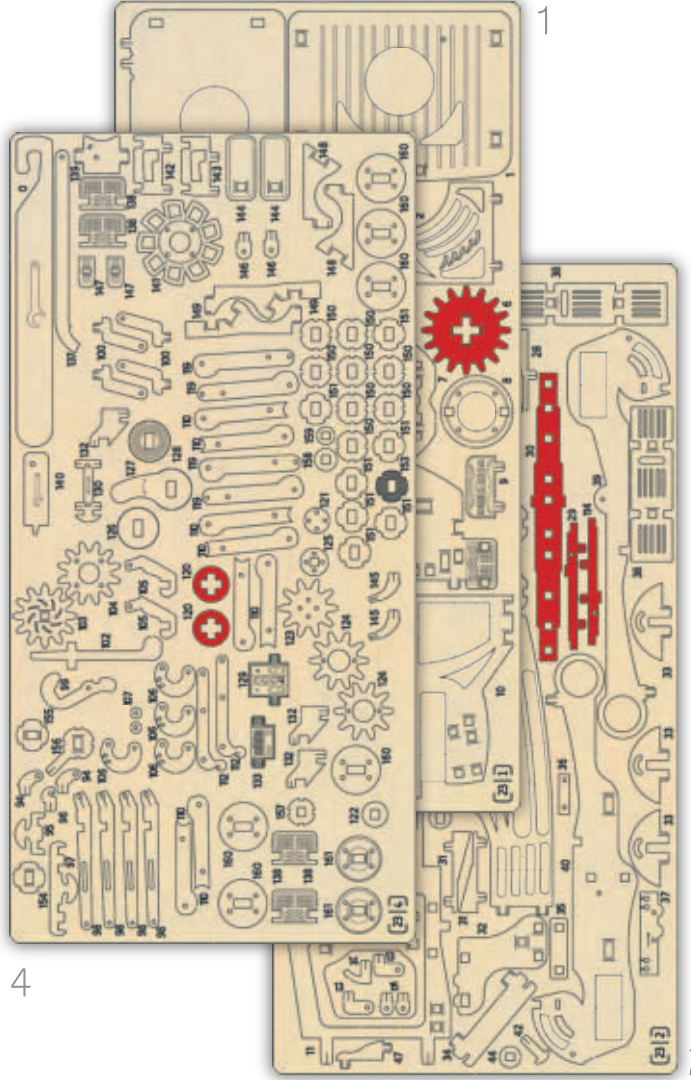

[31]



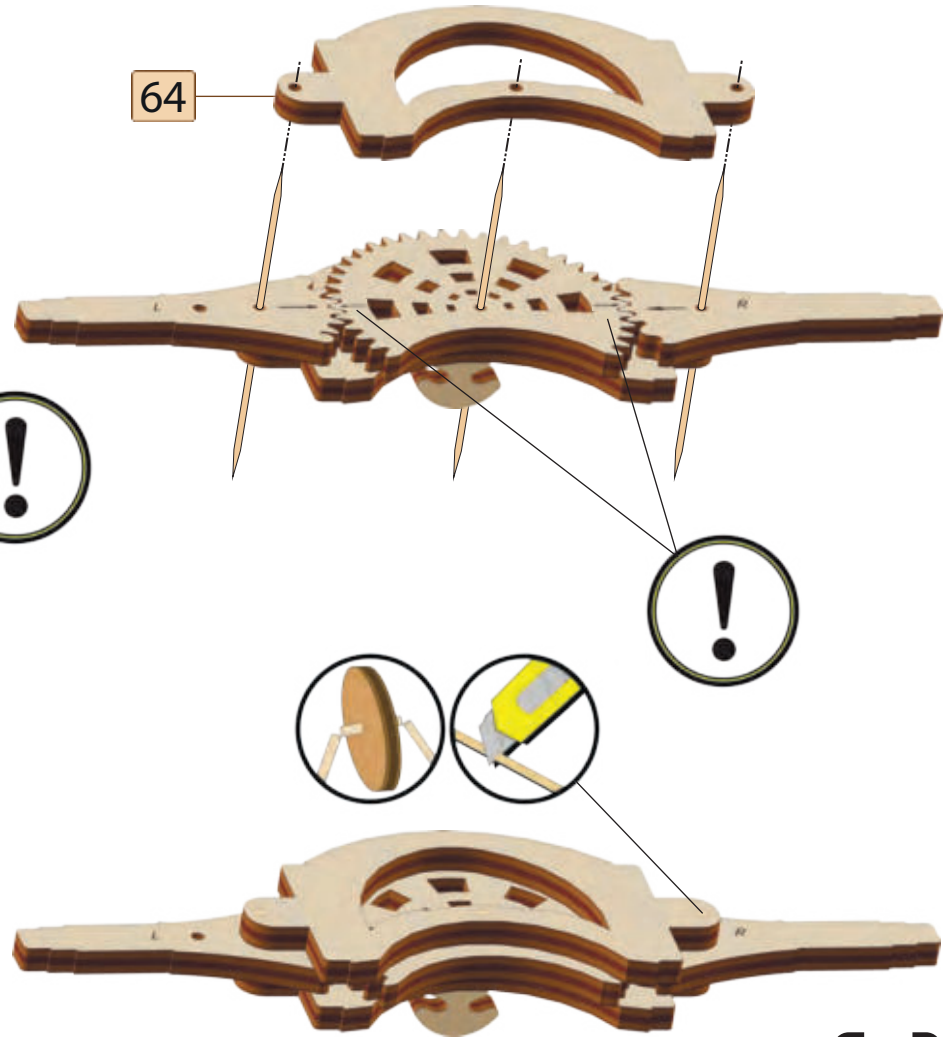
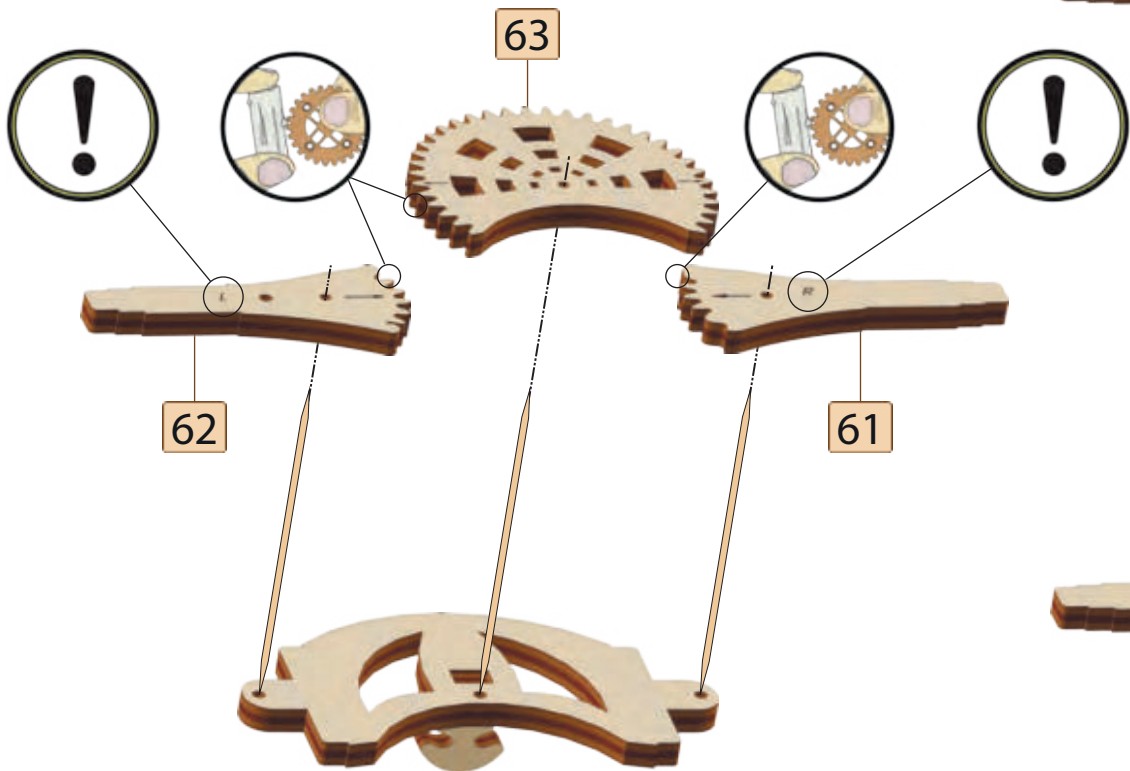
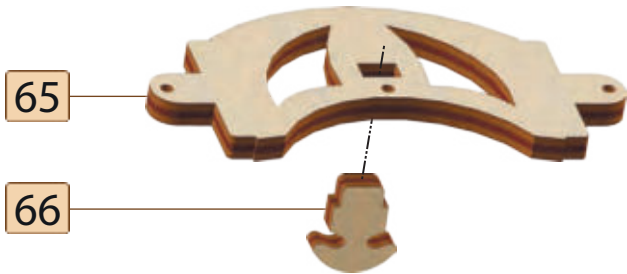
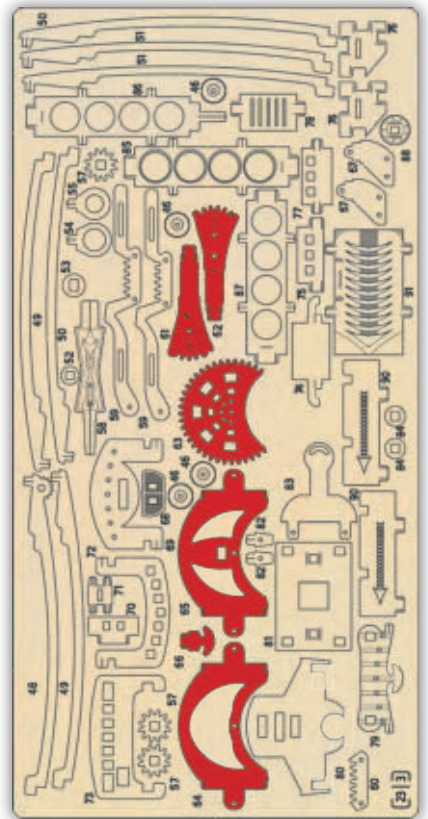

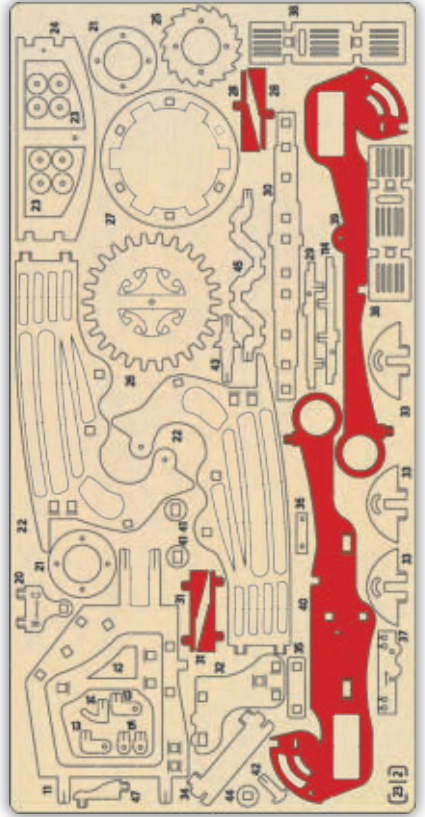

2

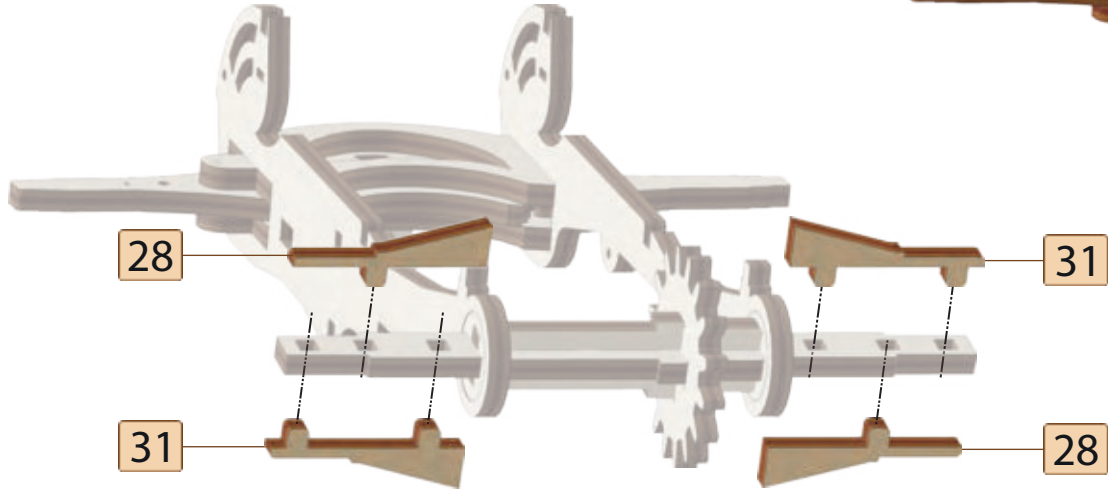
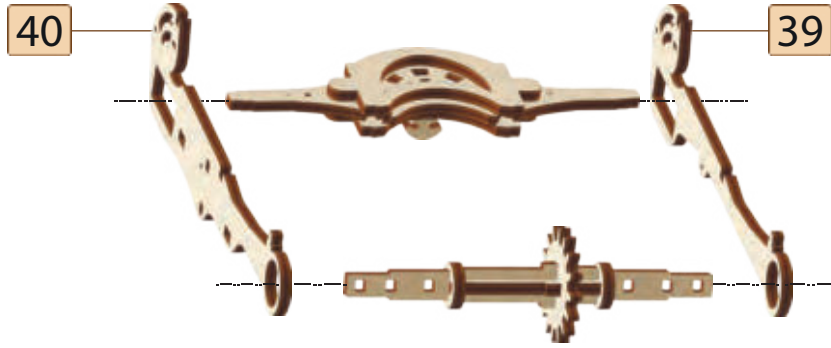

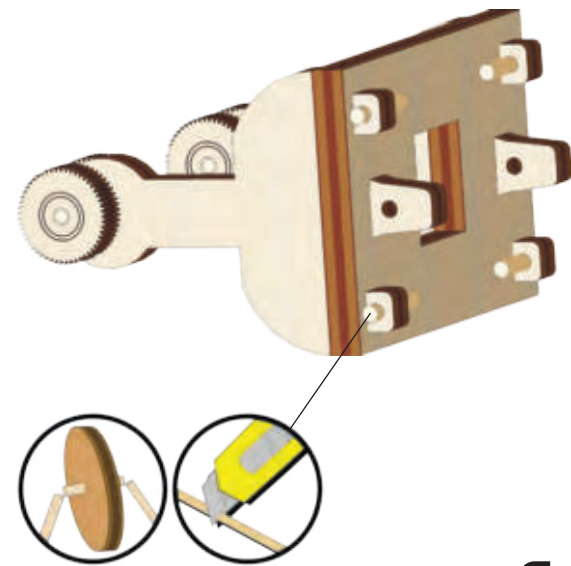
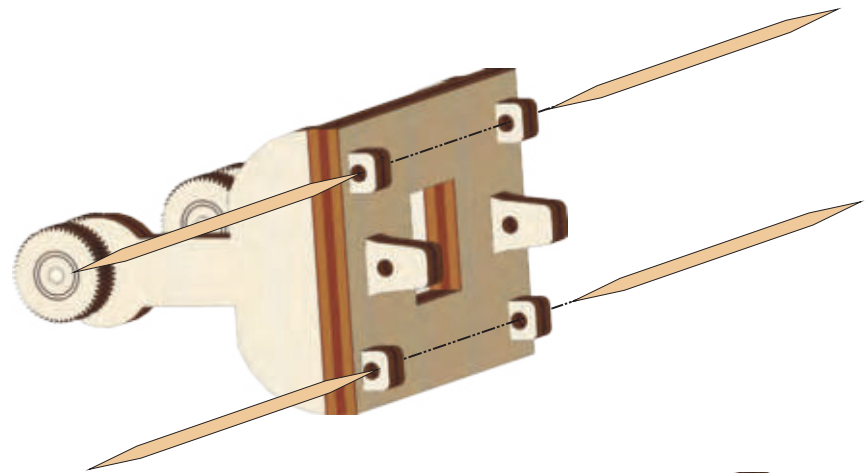
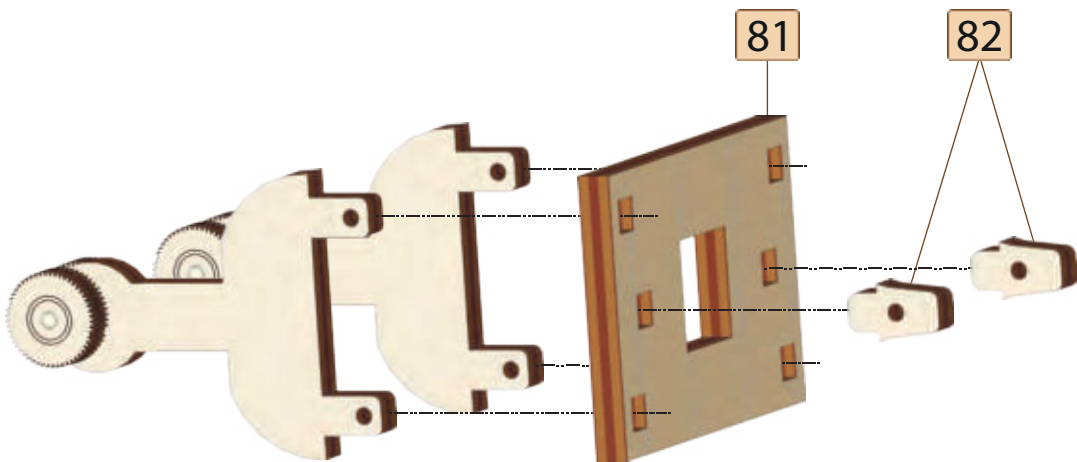
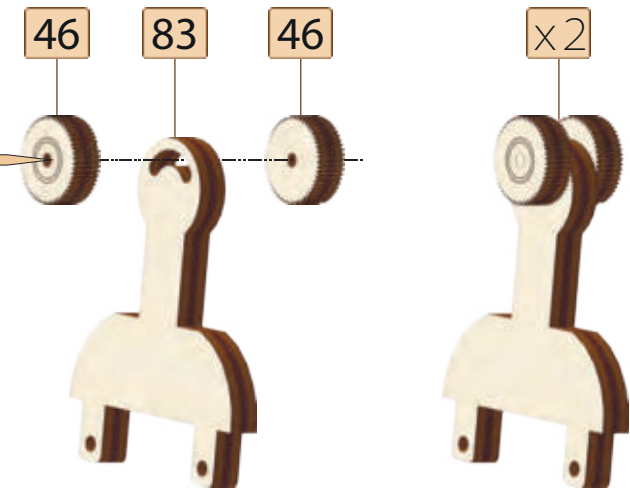
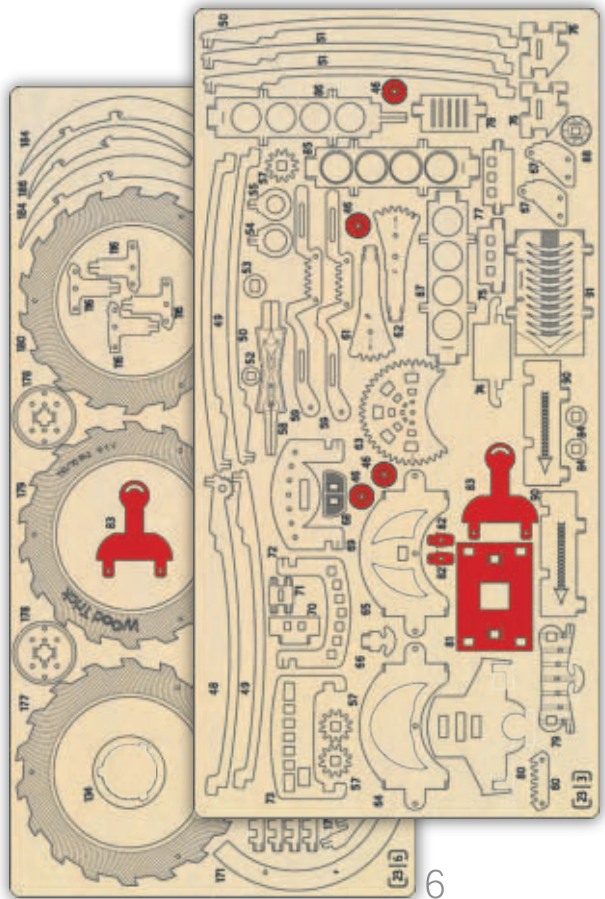

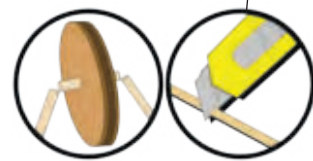
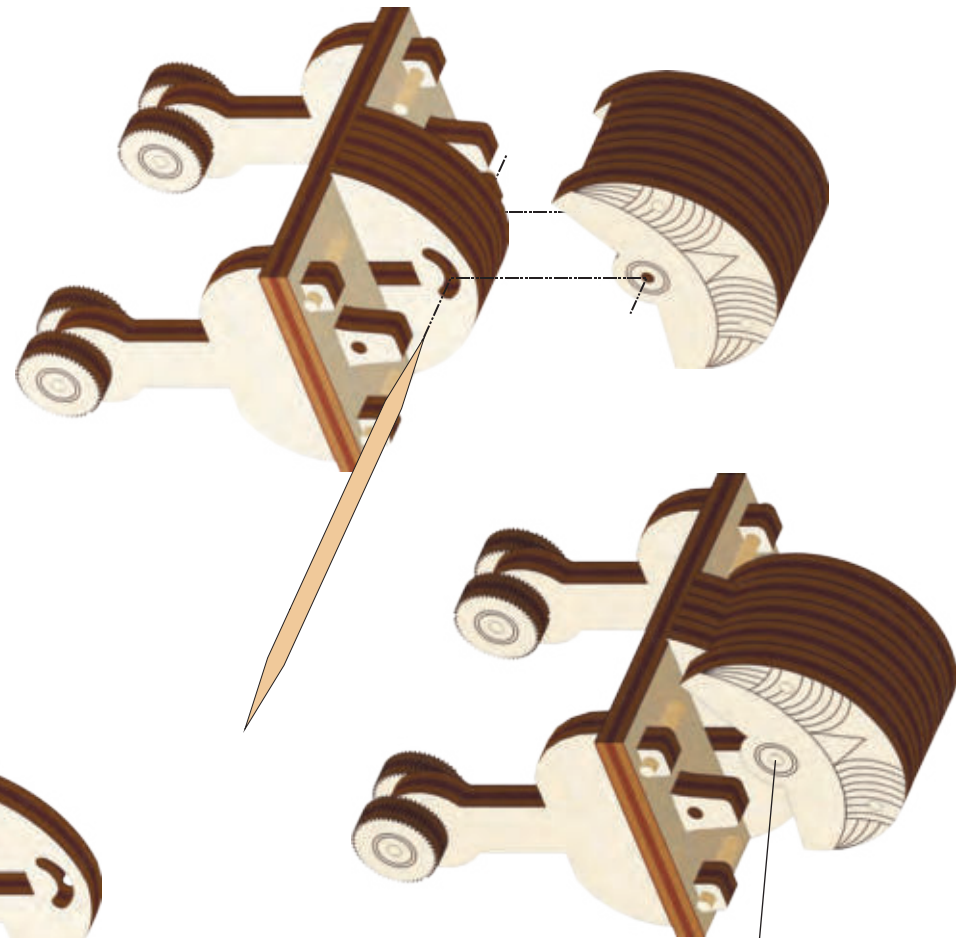
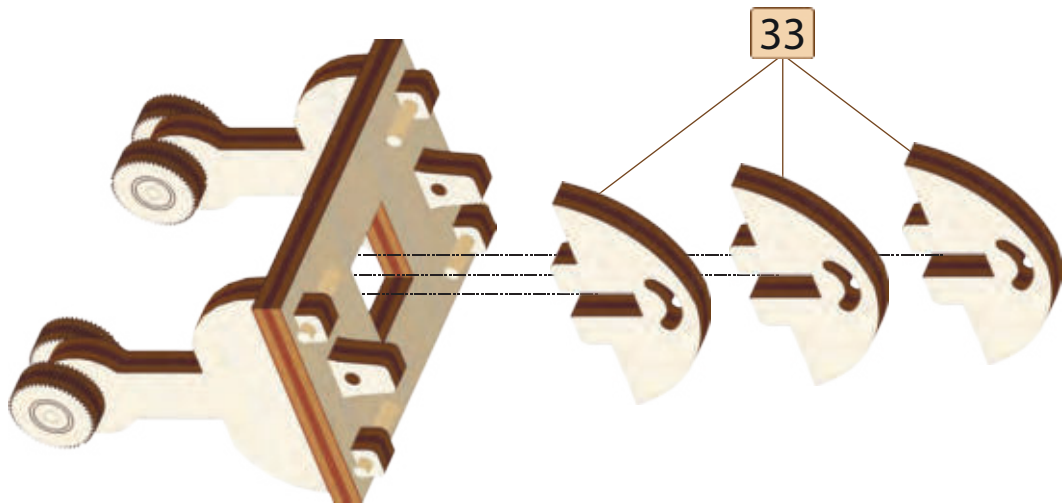
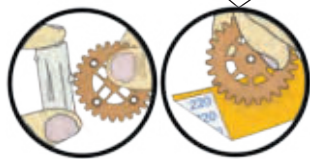
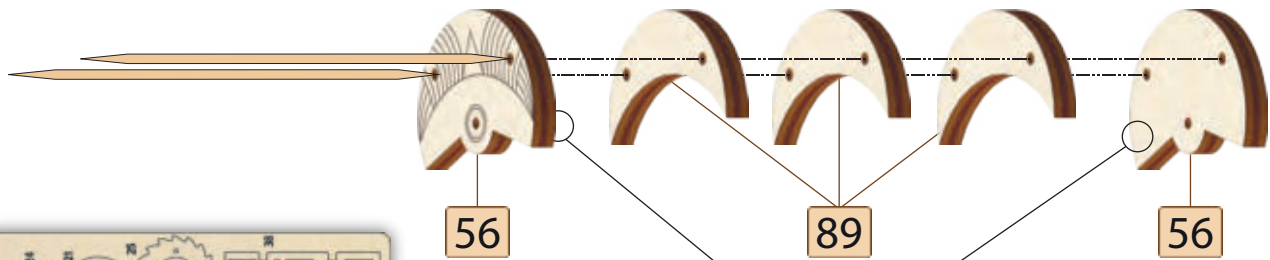
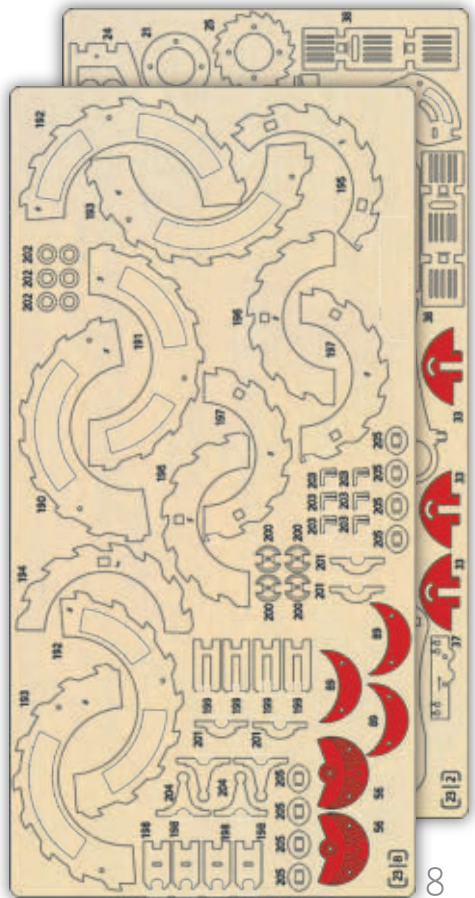

[35]

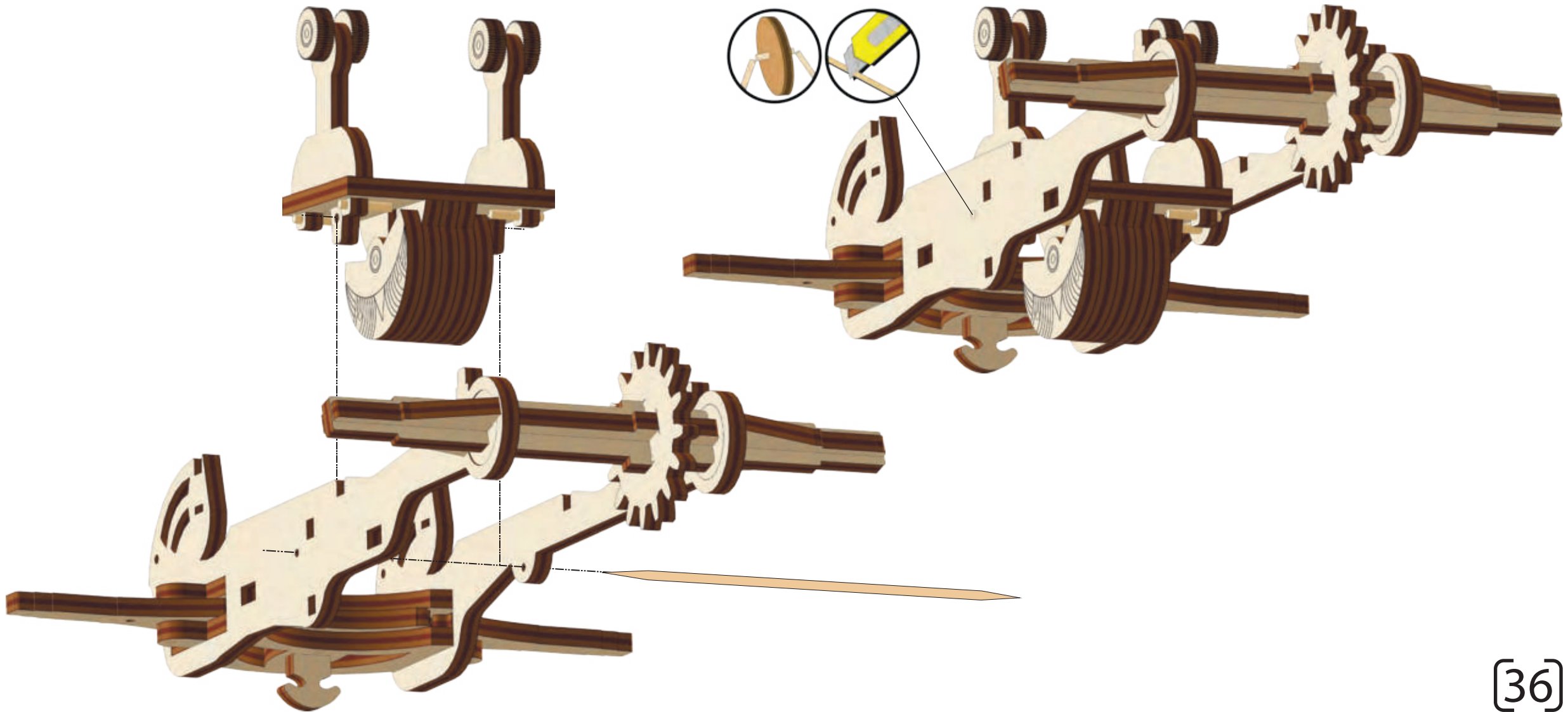

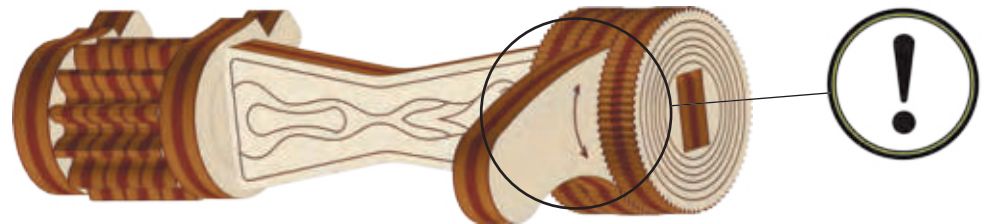
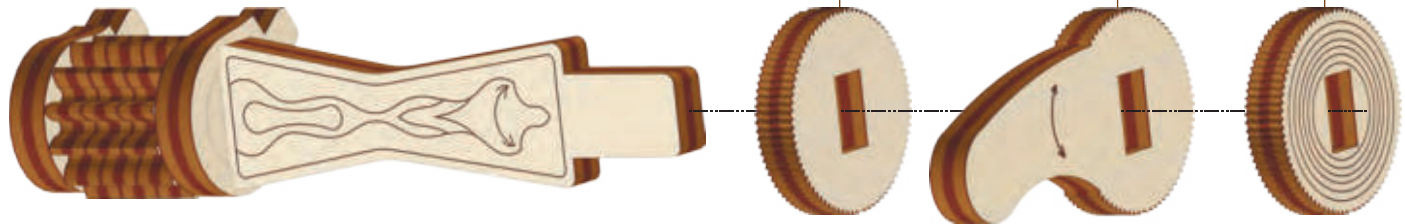
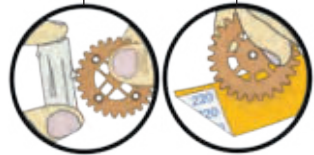
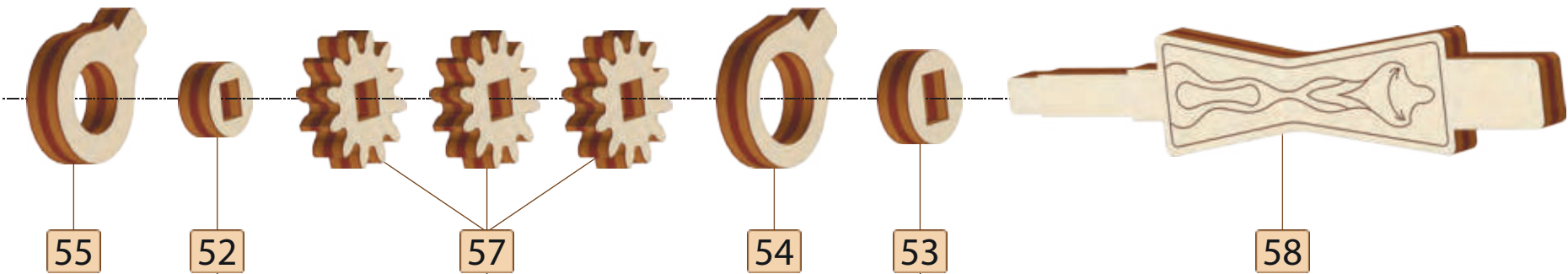
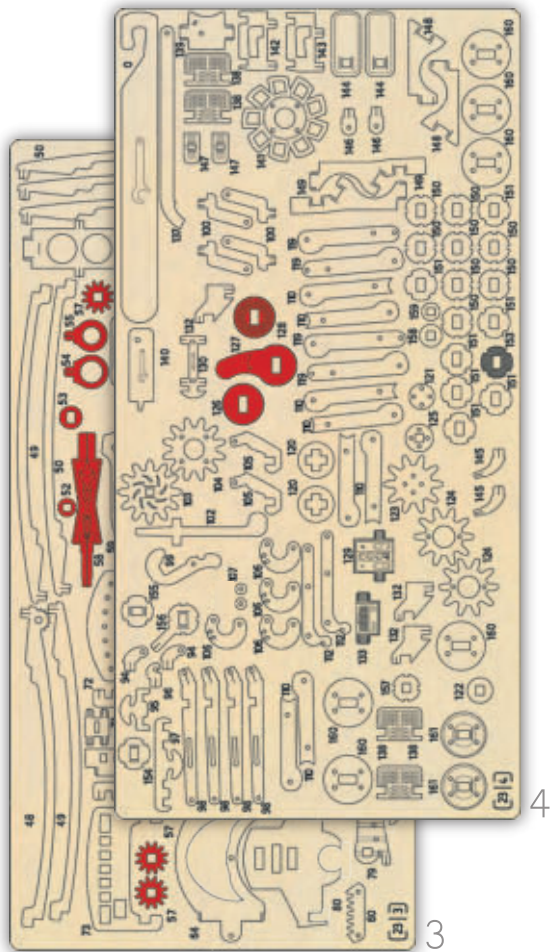

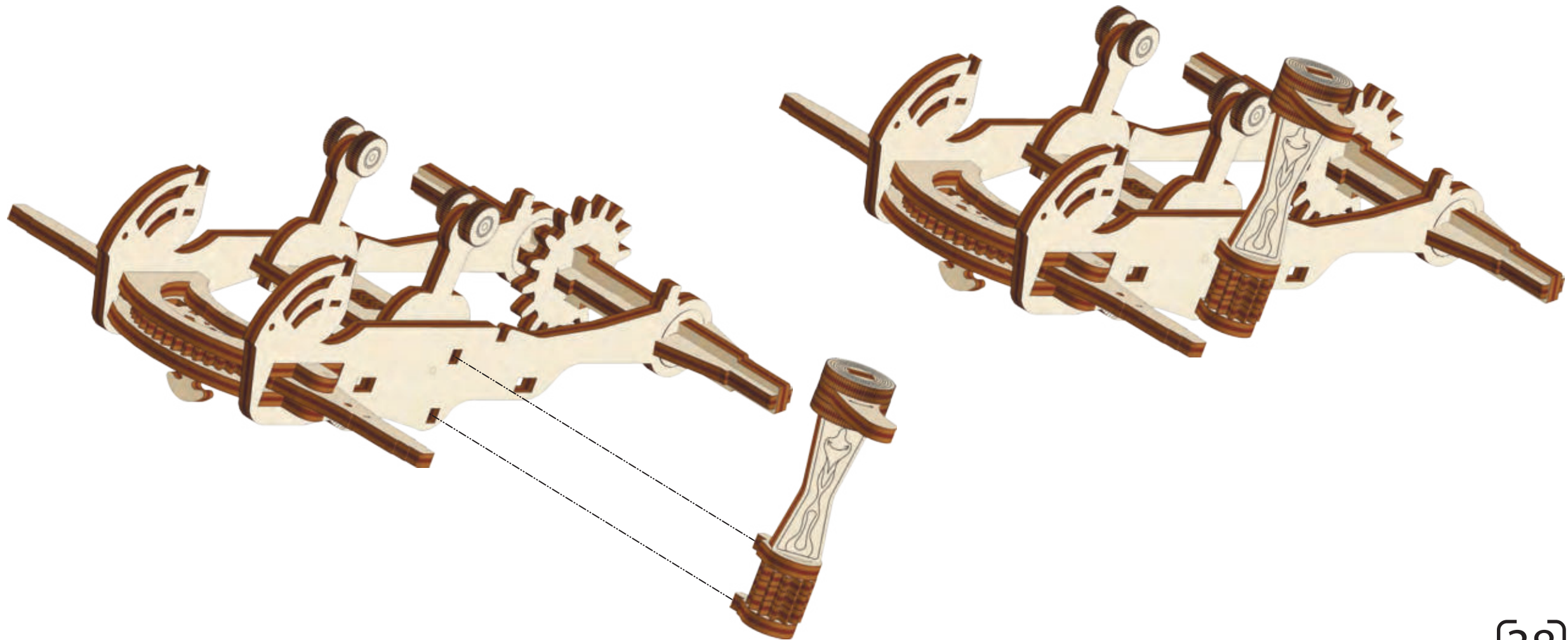

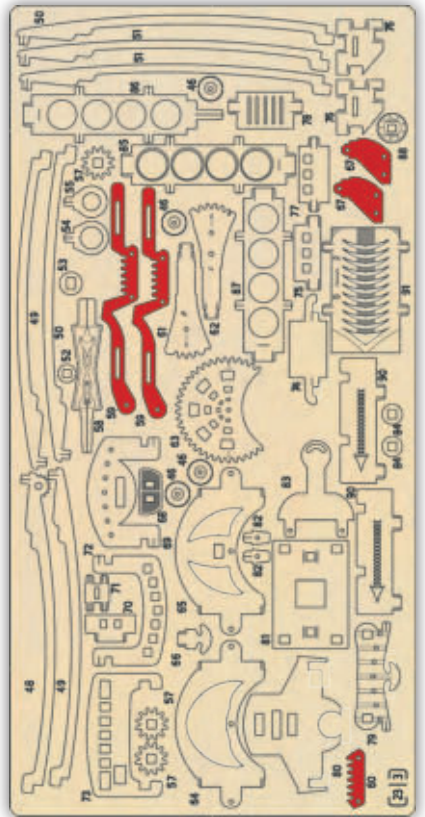

3

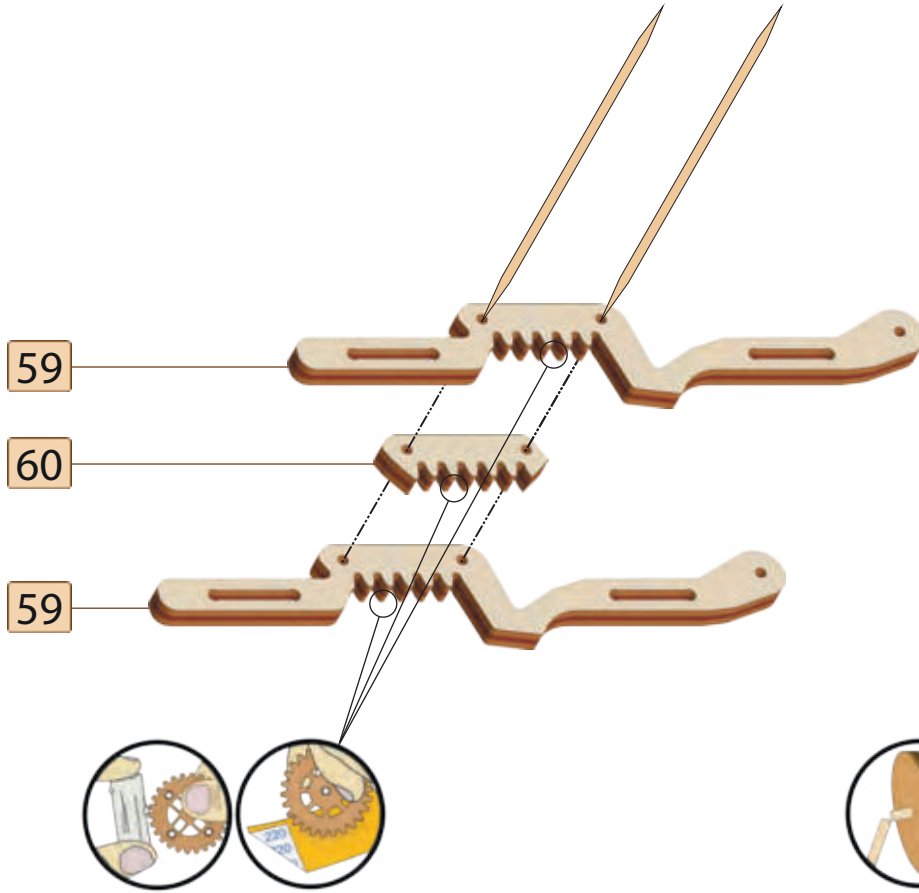

59

60

59

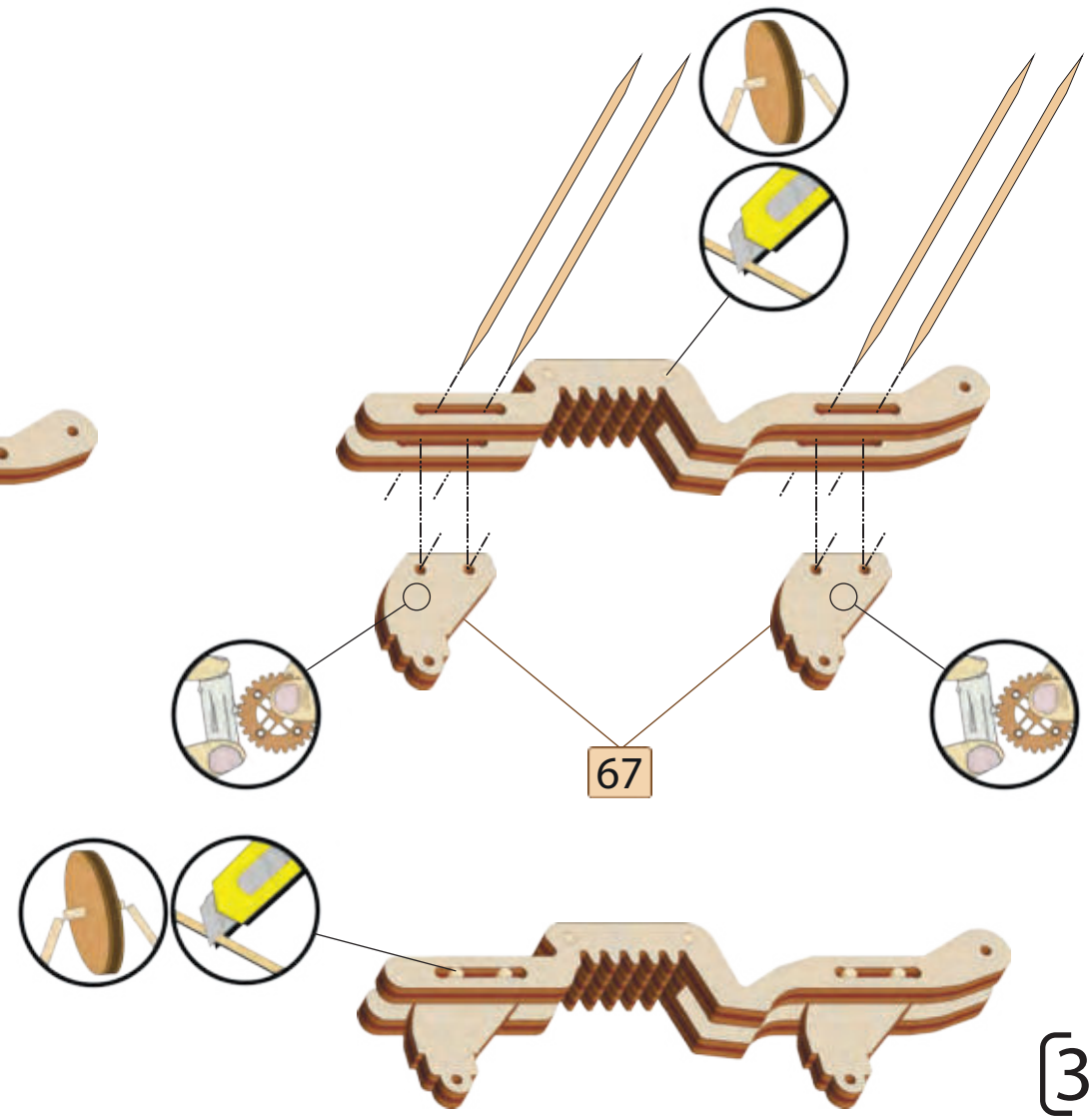

67

39



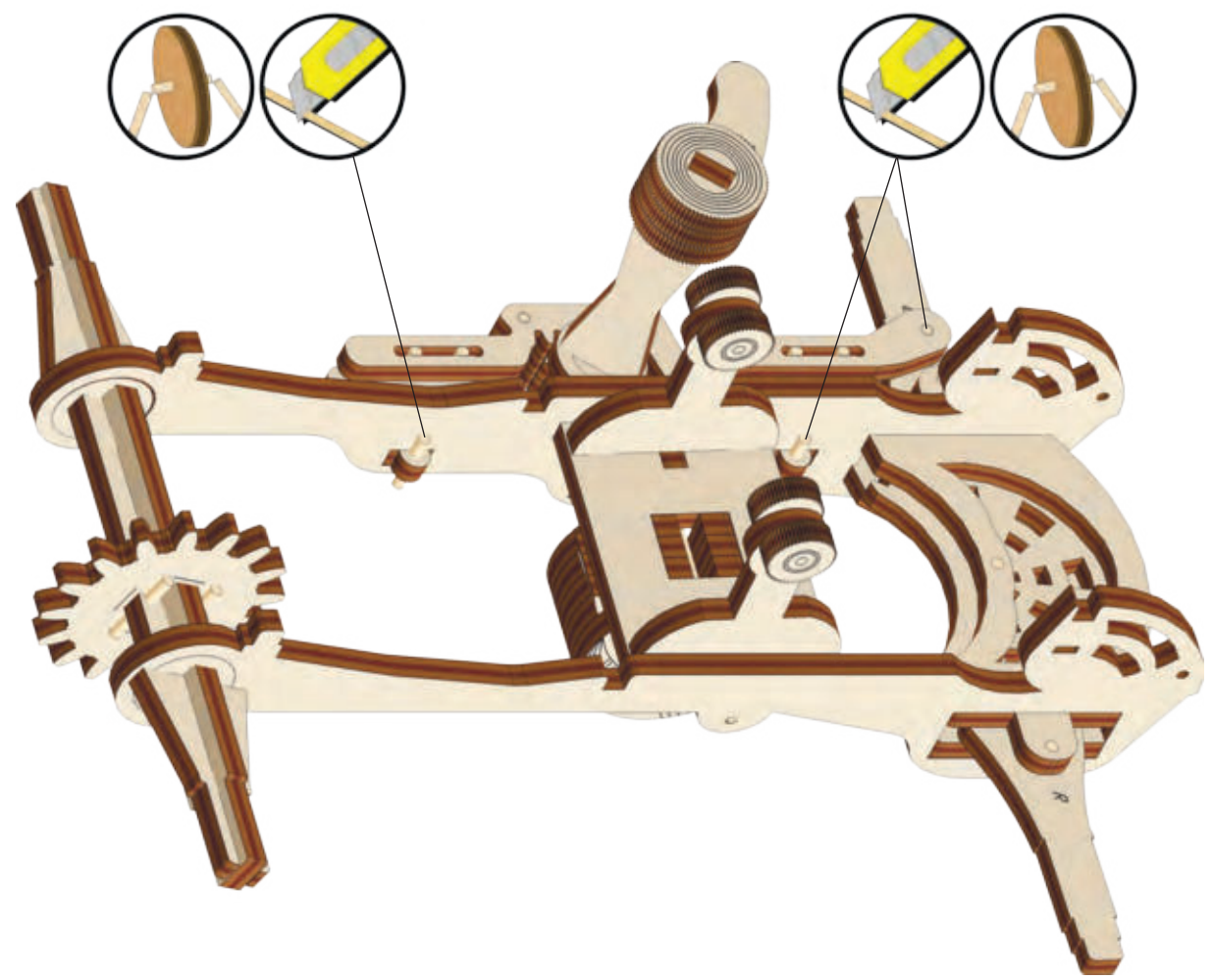
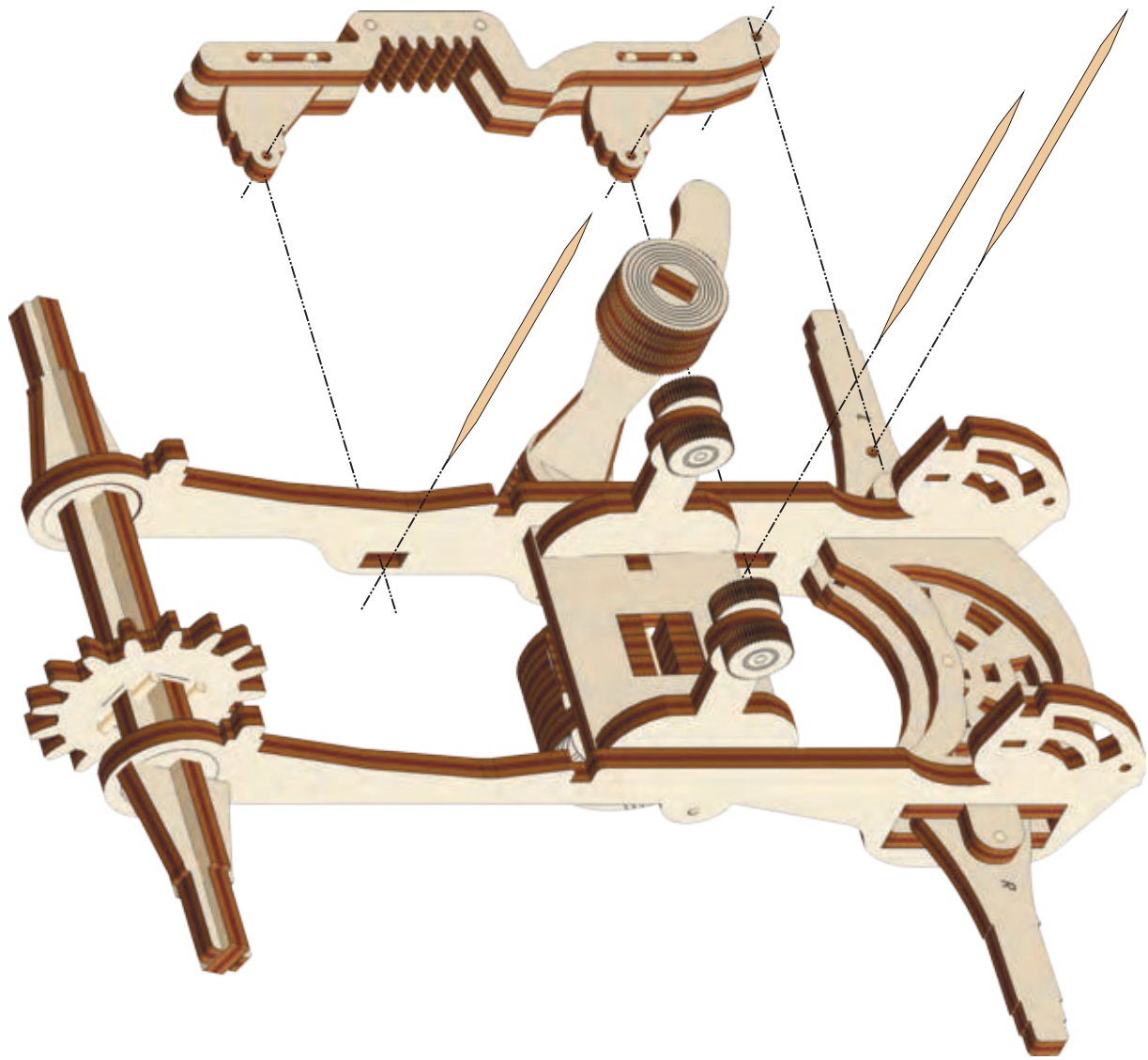

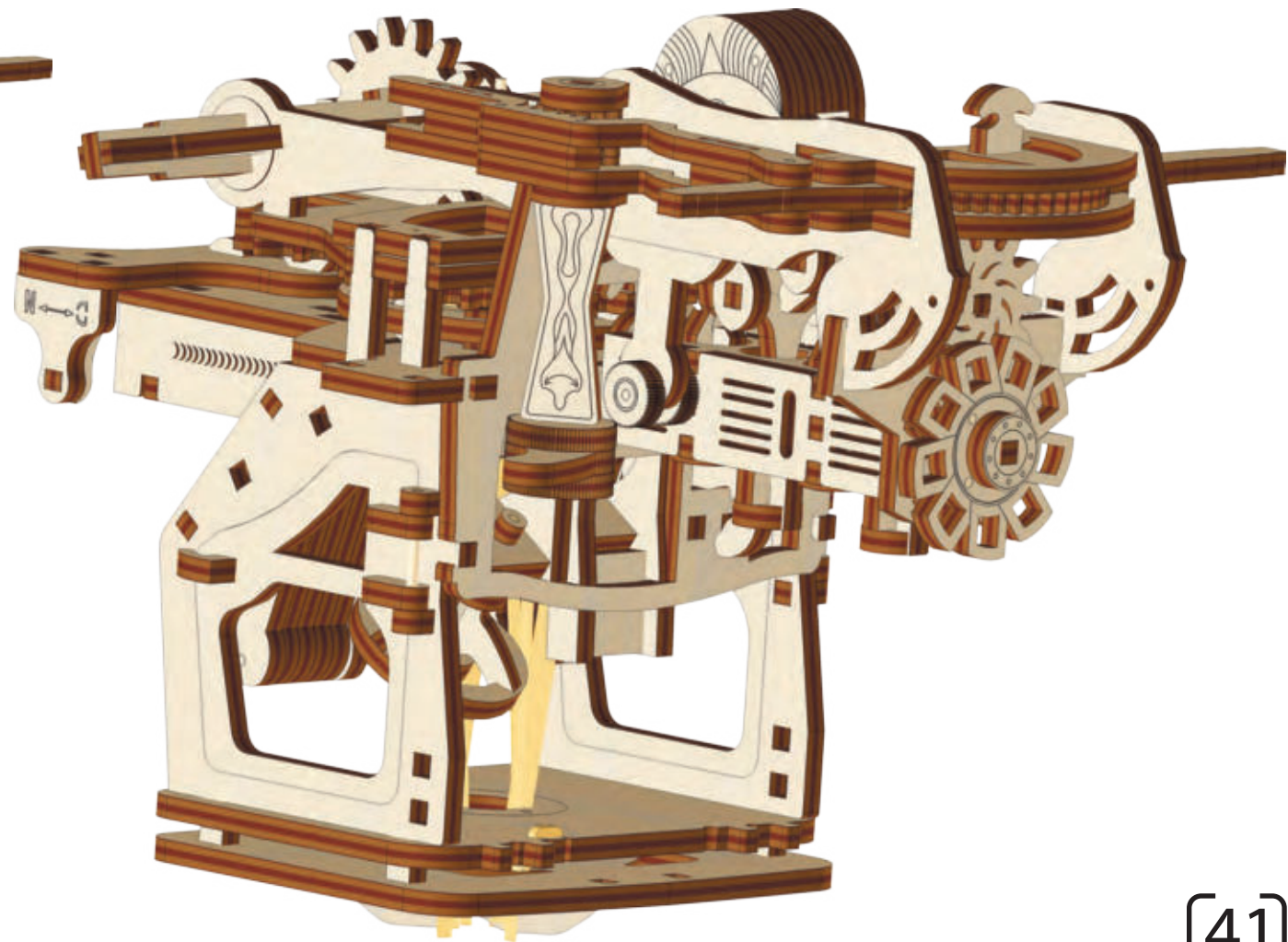
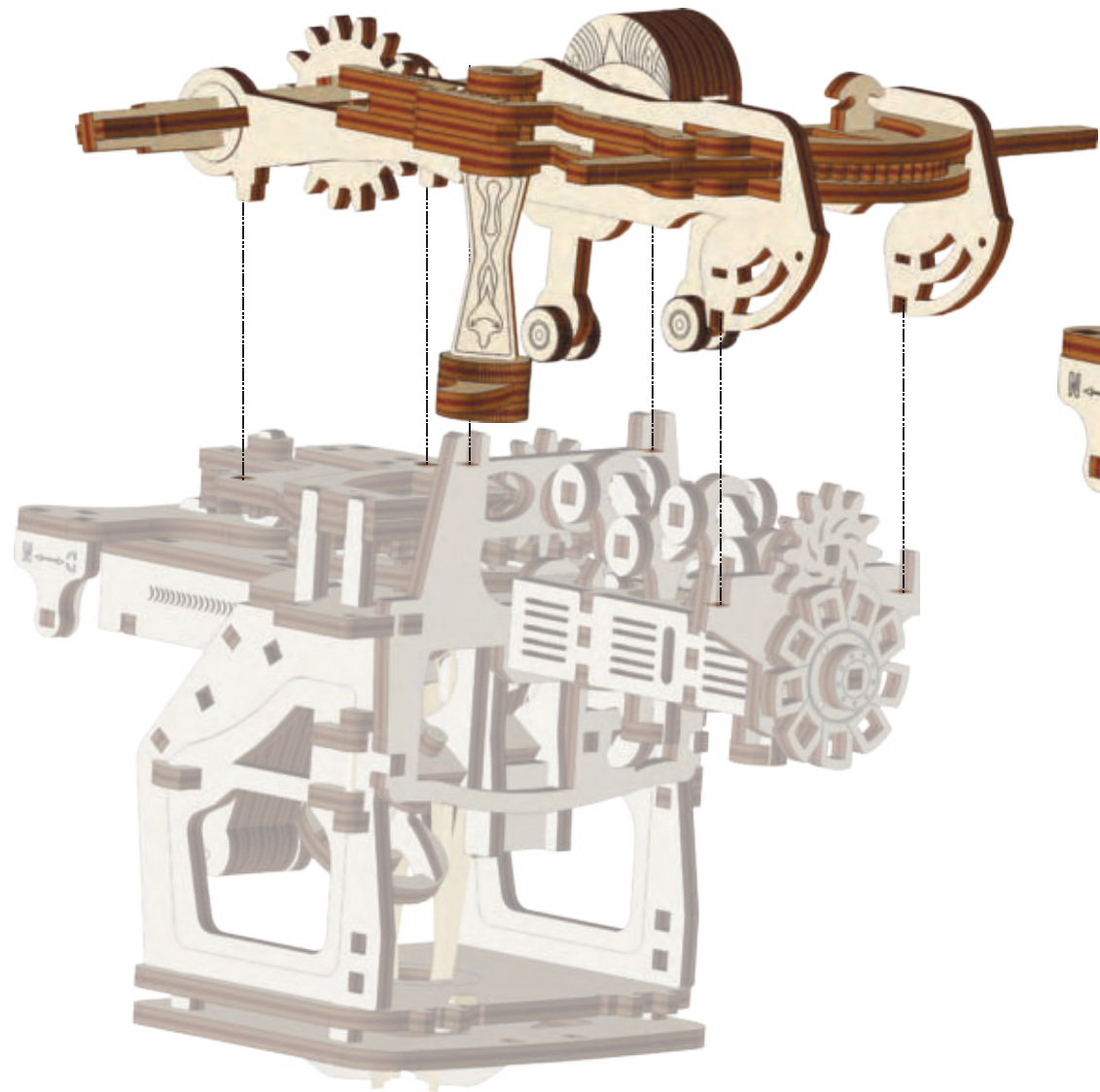

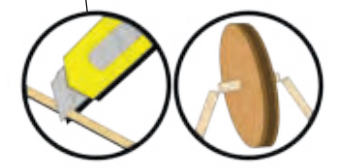
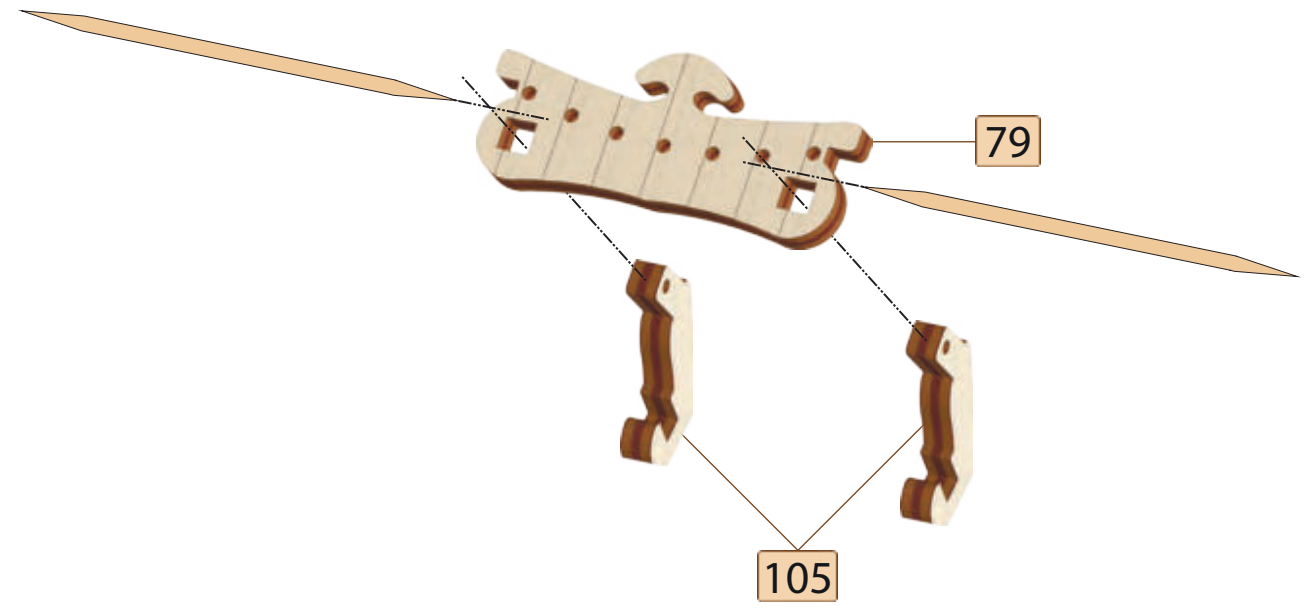
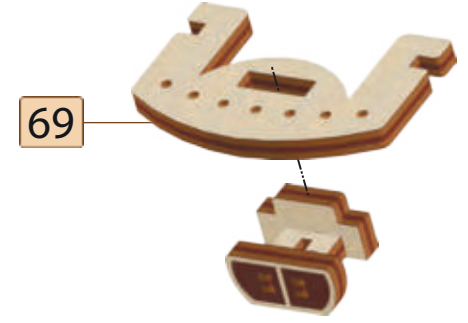
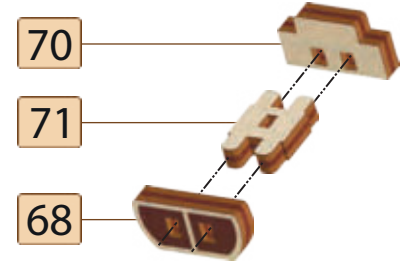
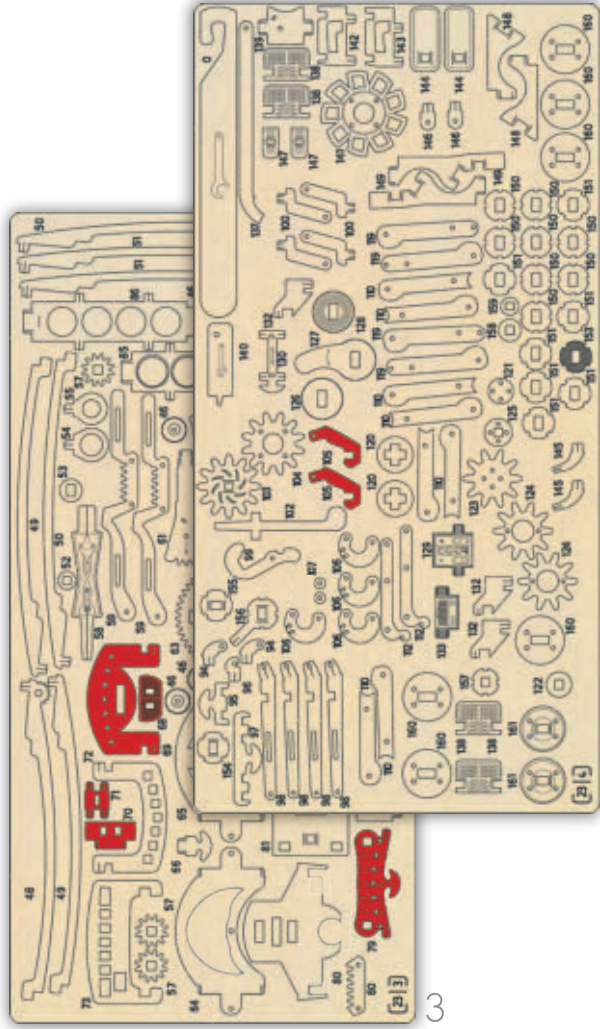

[42]

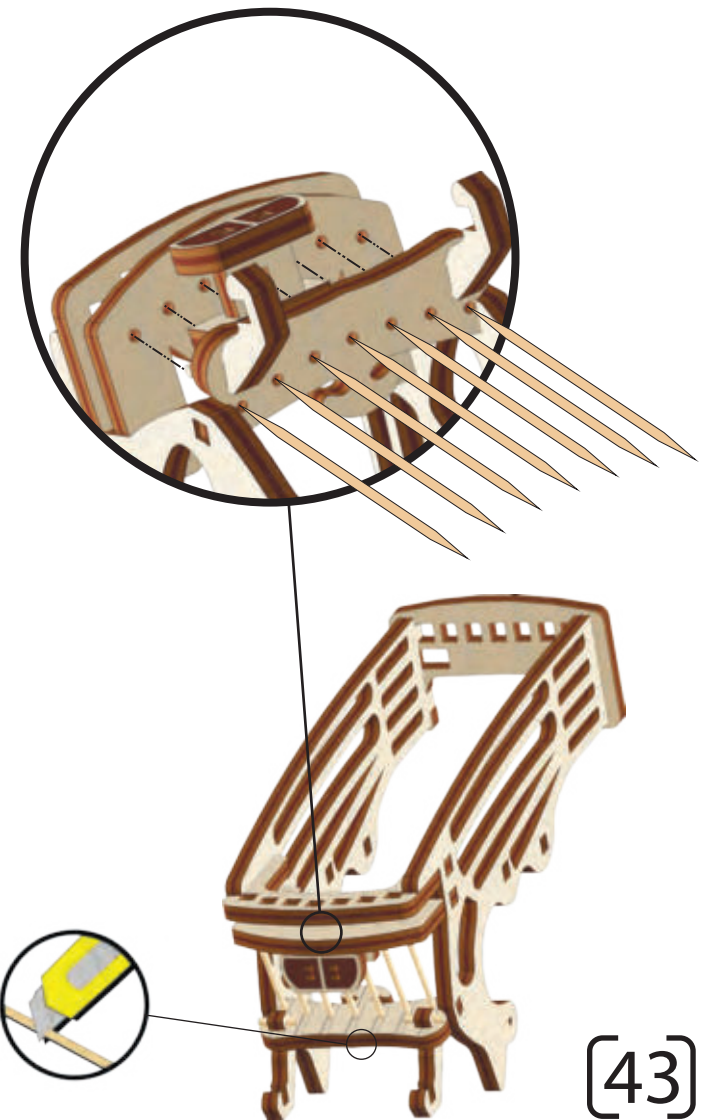
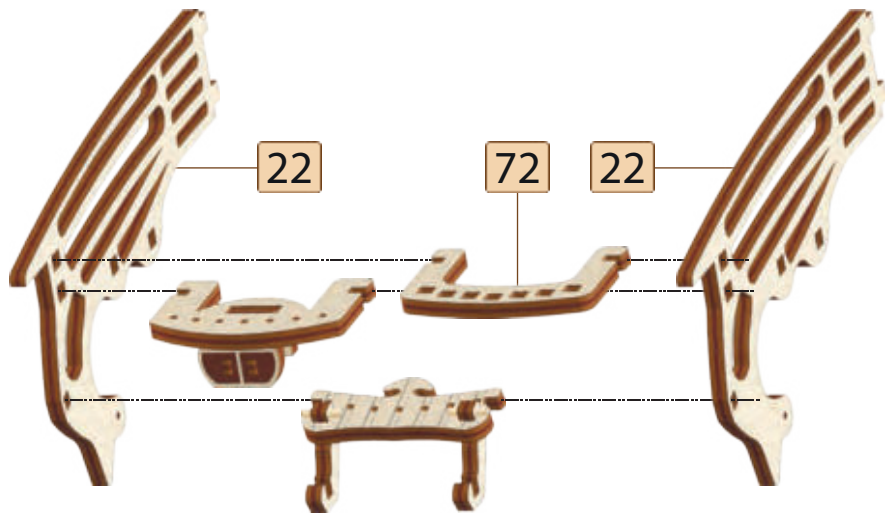
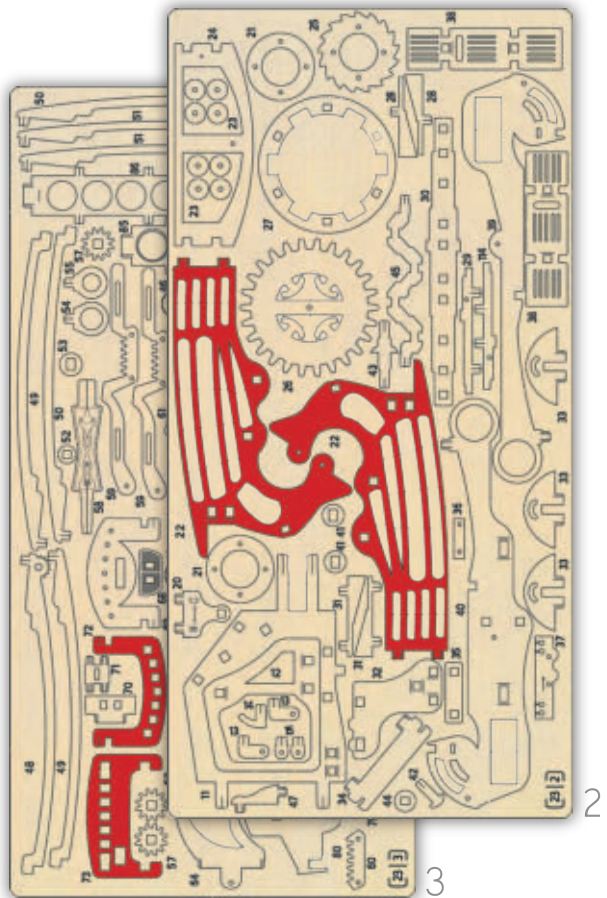

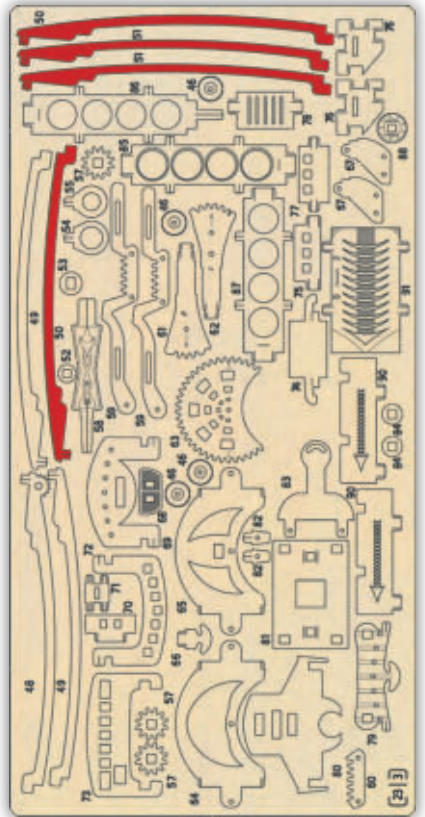

3

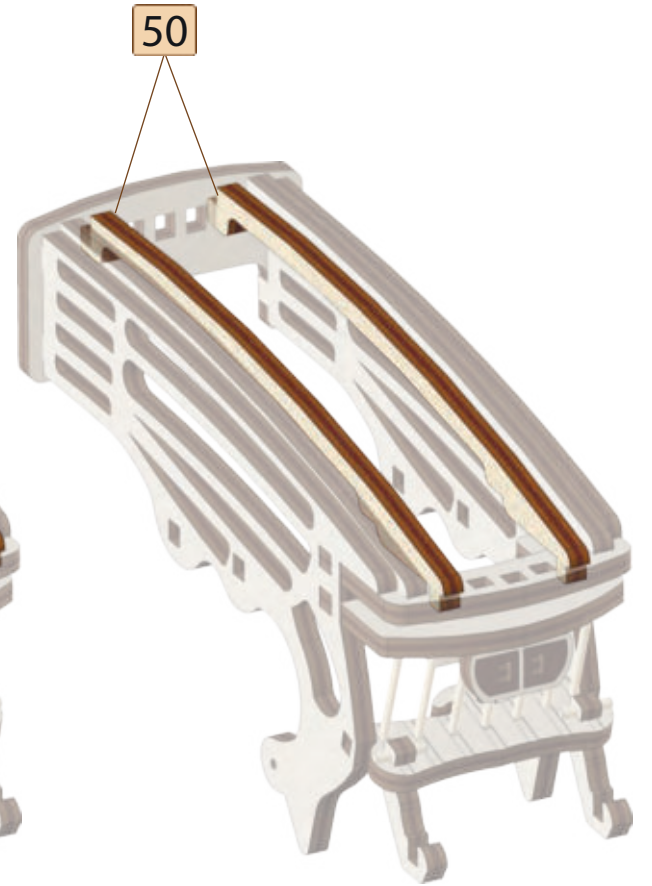
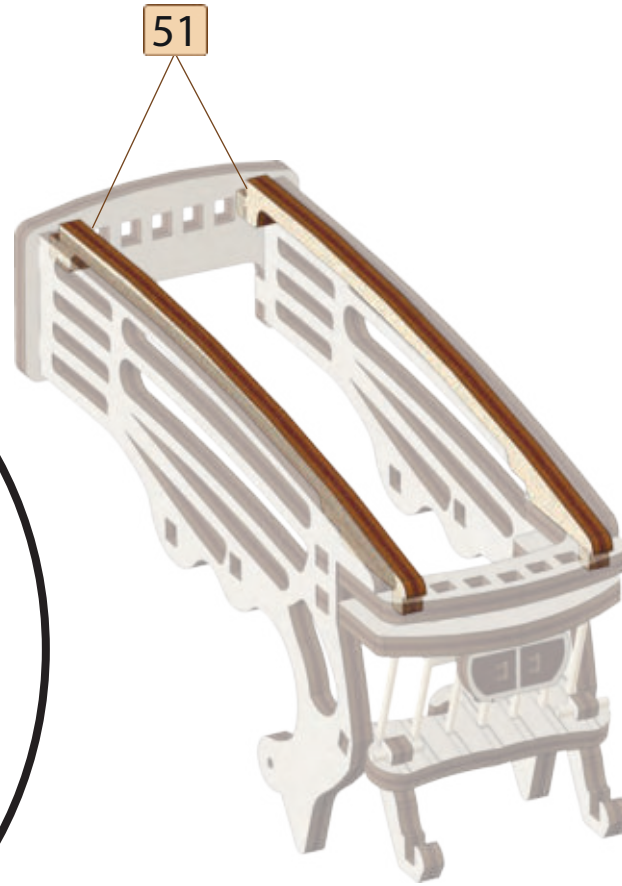
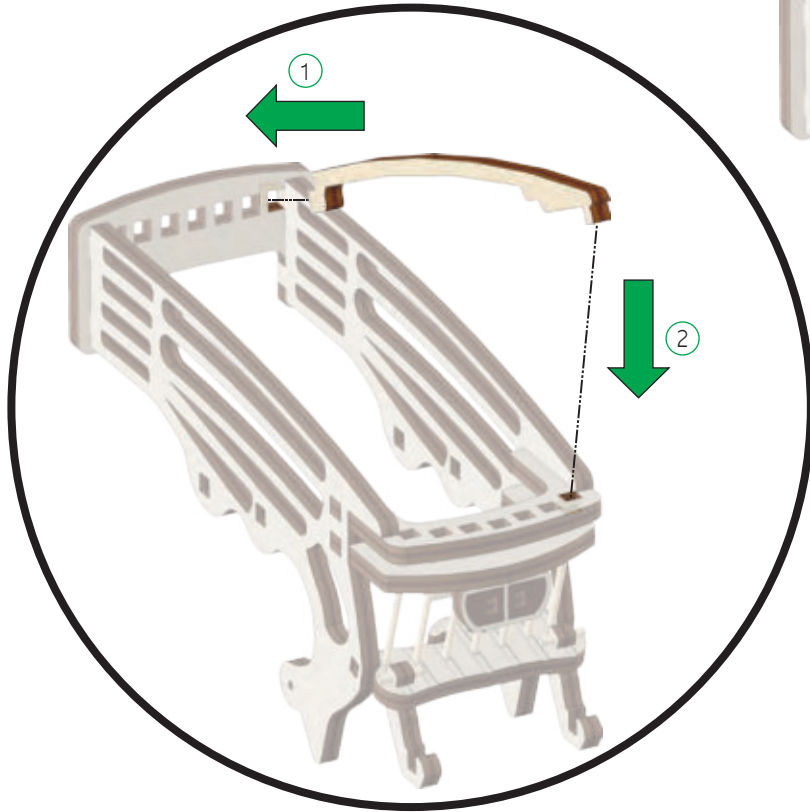

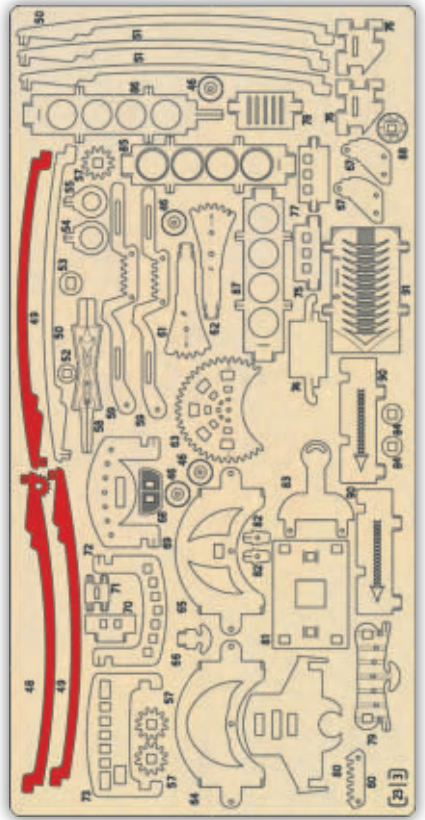

3



49

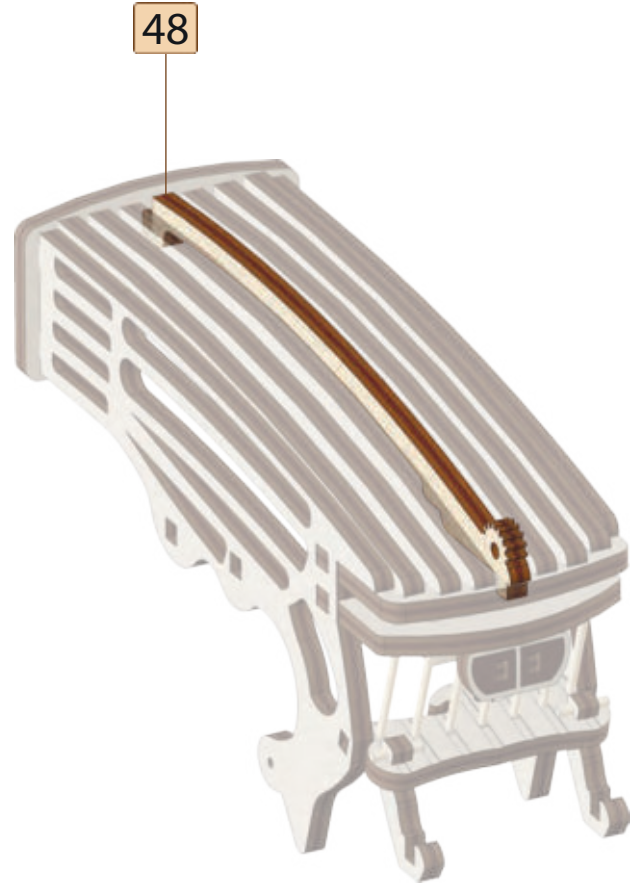

48

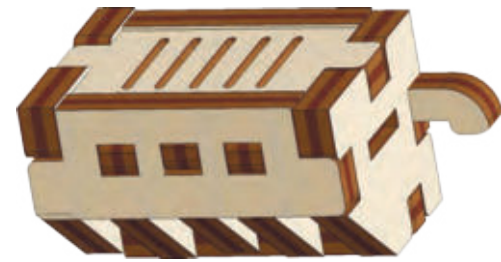
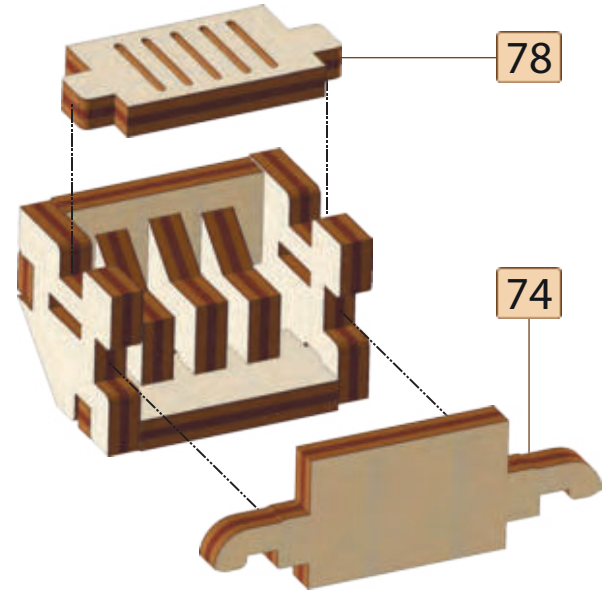
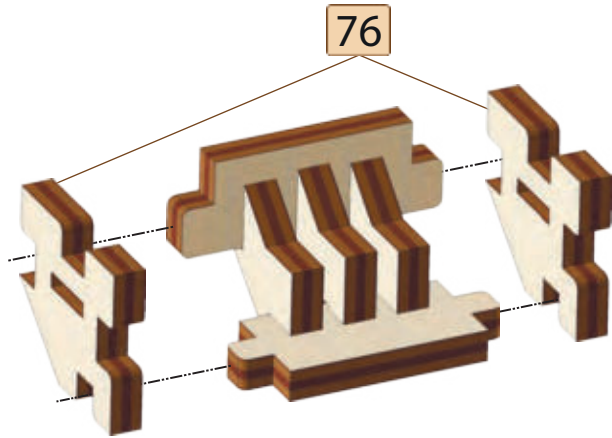
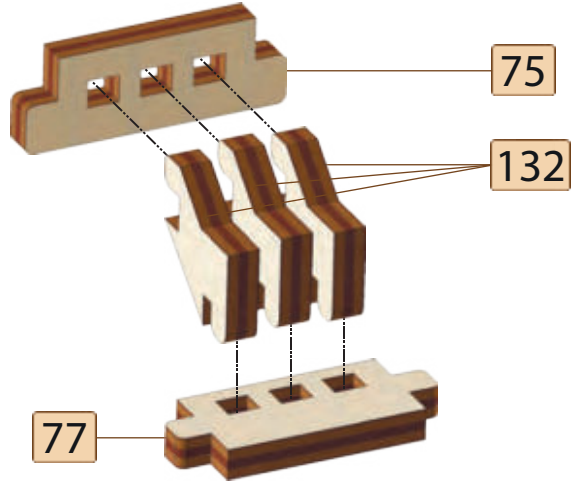
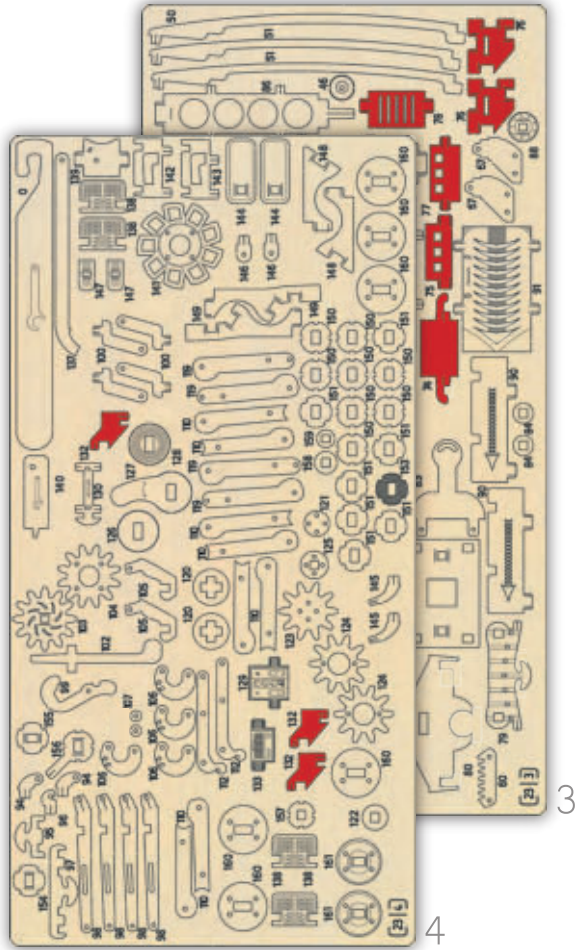





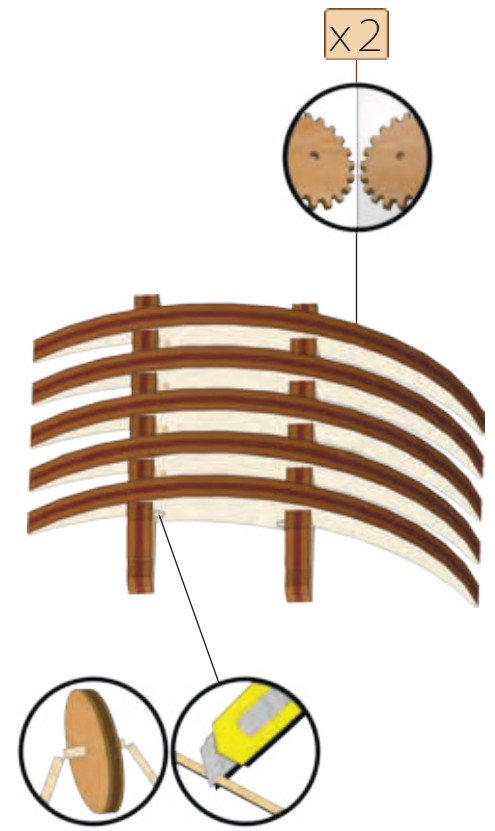
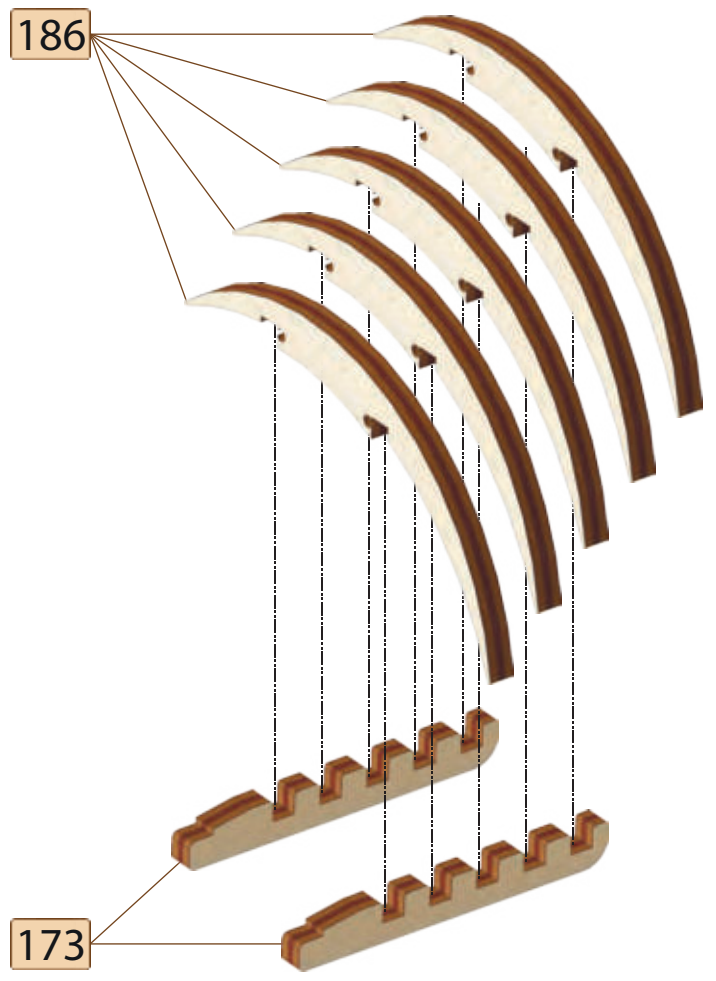



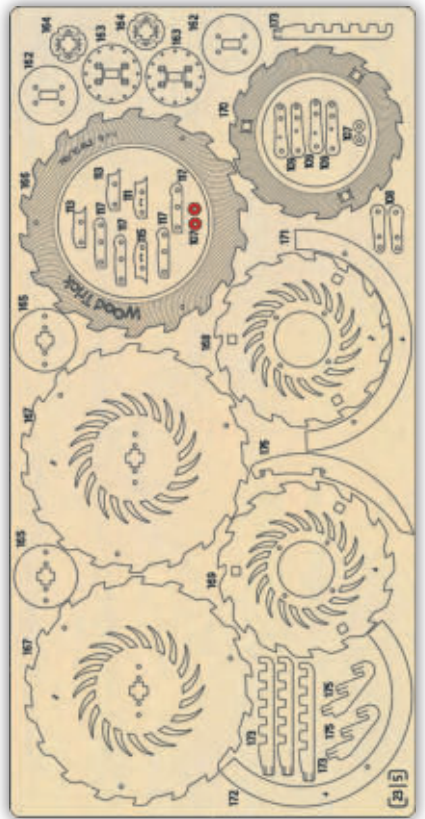

5

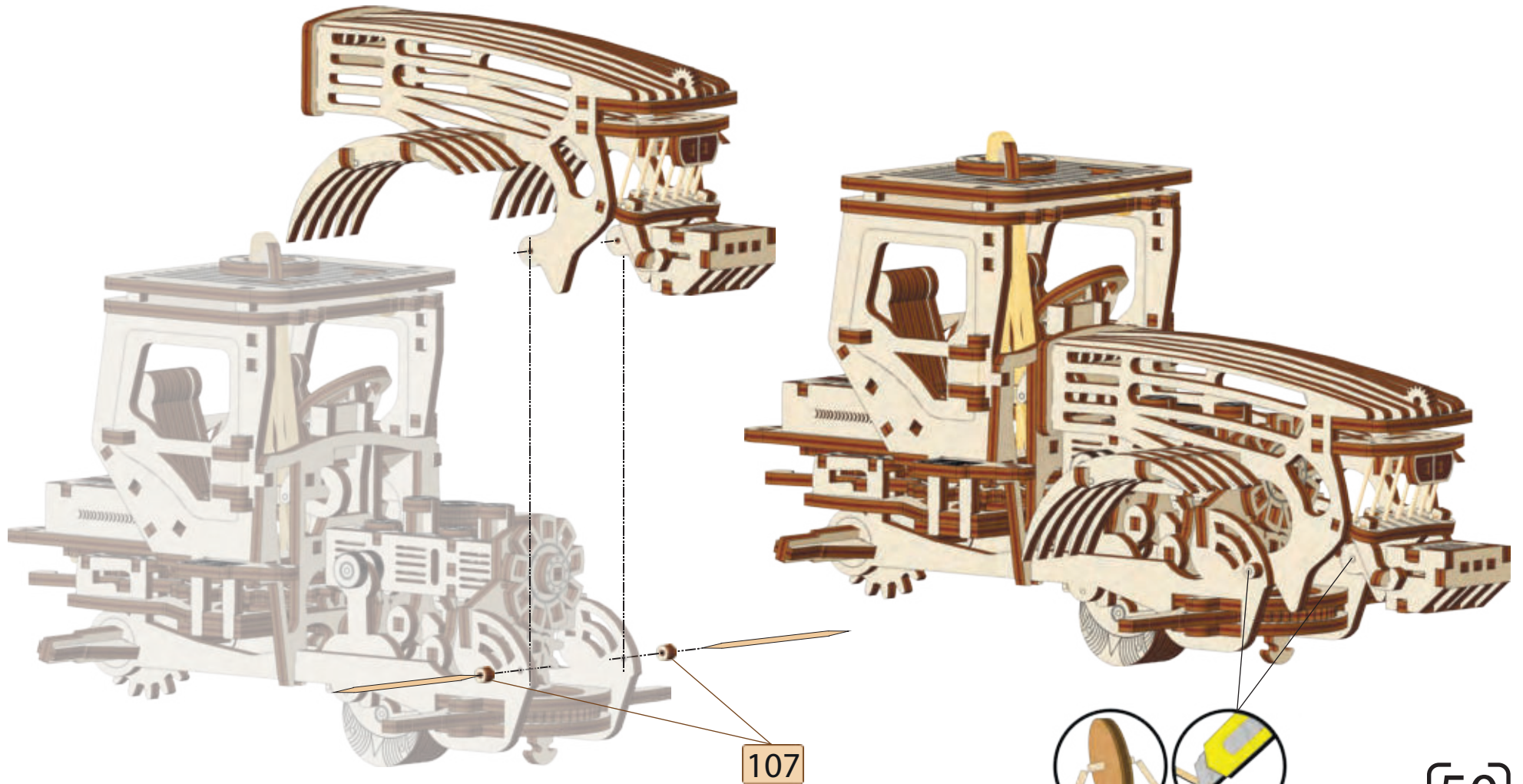

107

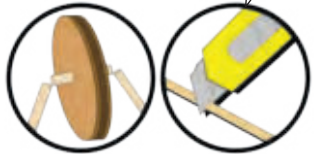

[50]

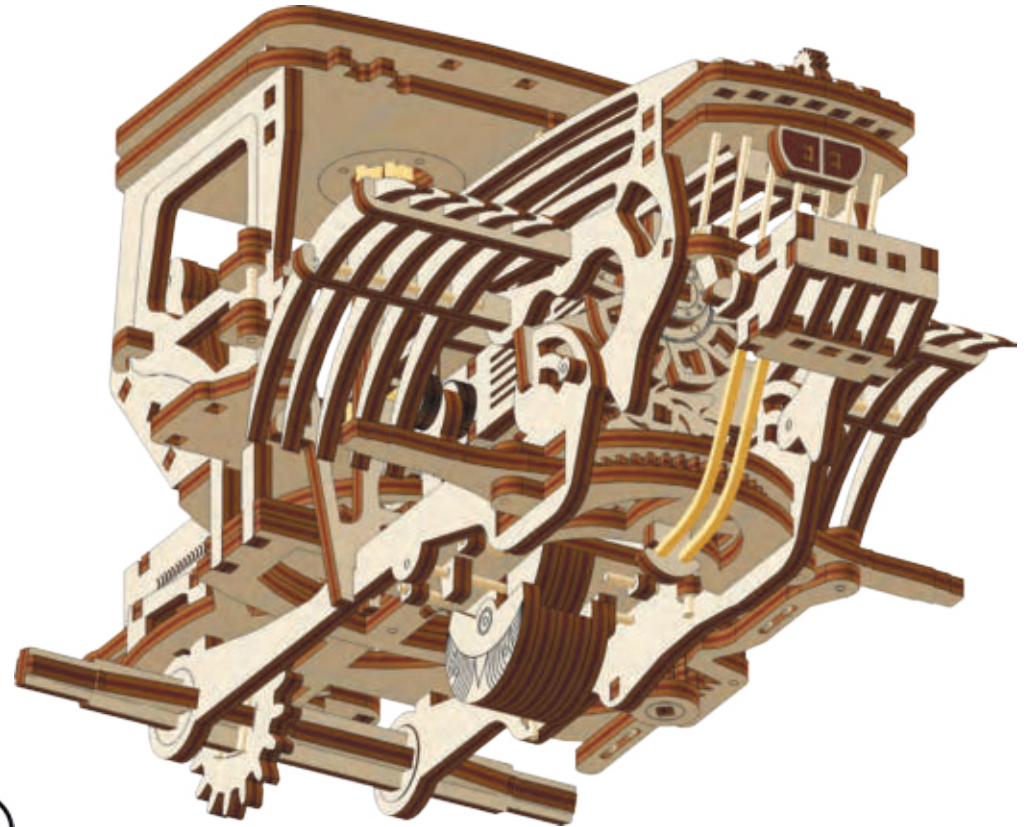
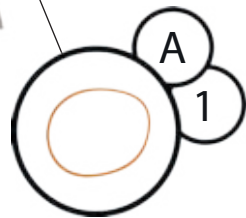
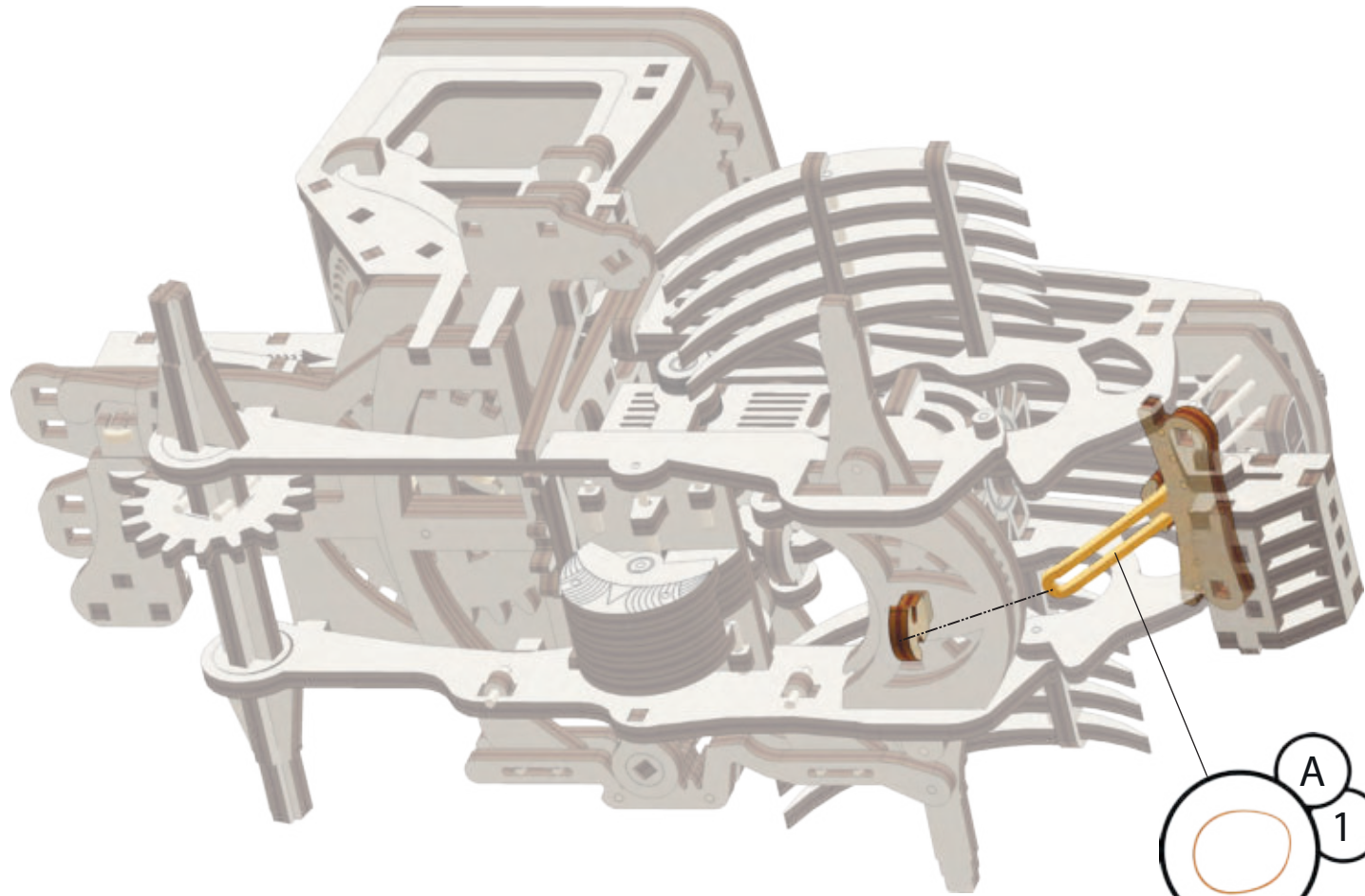

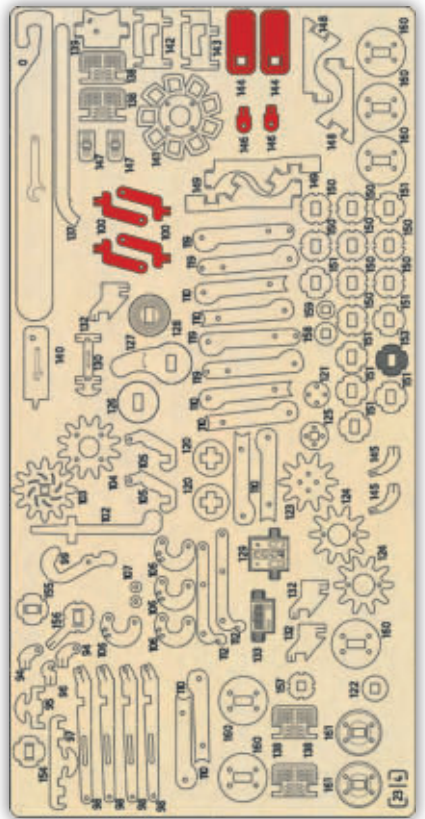

4

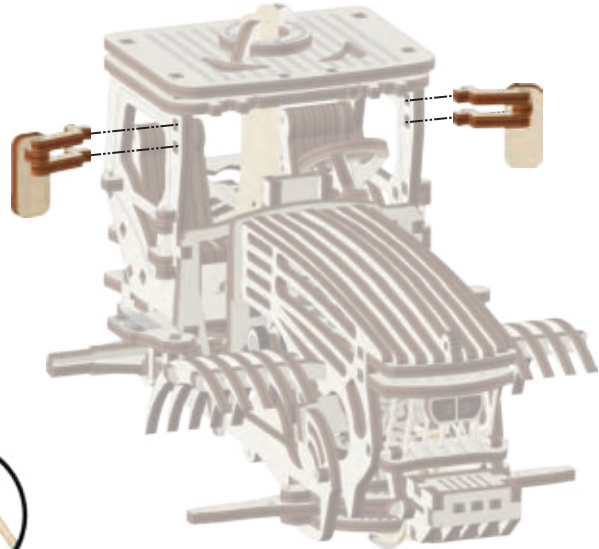
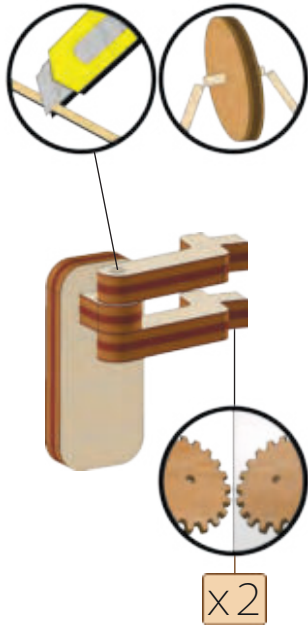
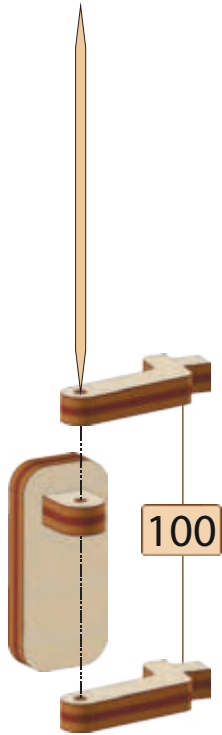
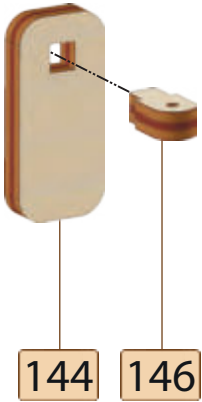

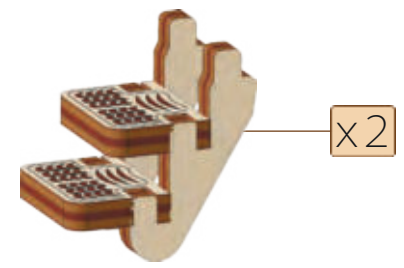
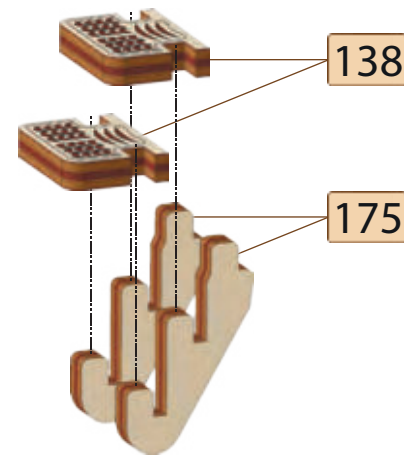
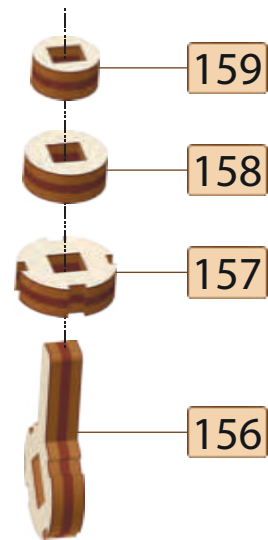
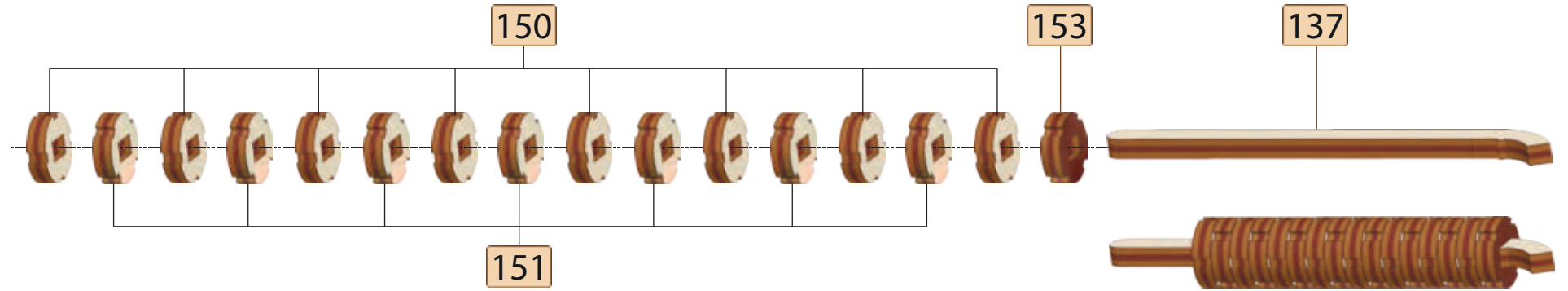
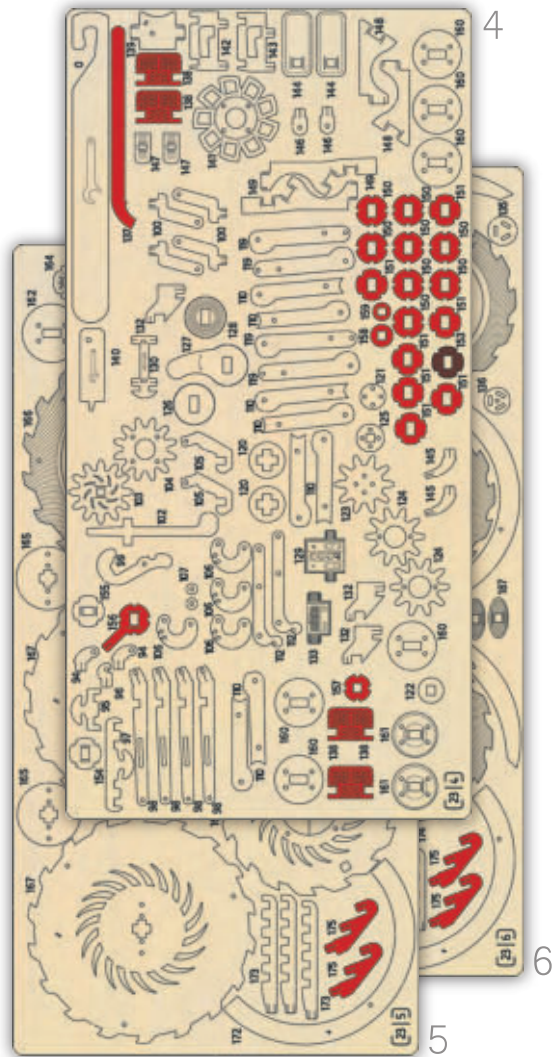

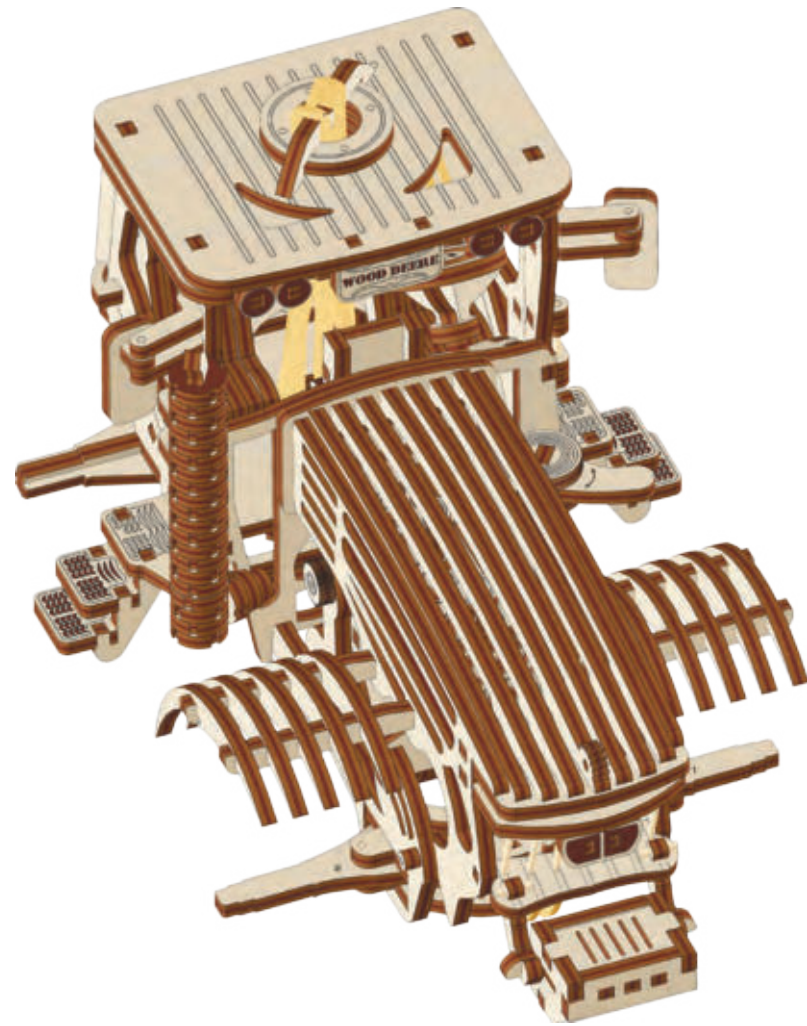
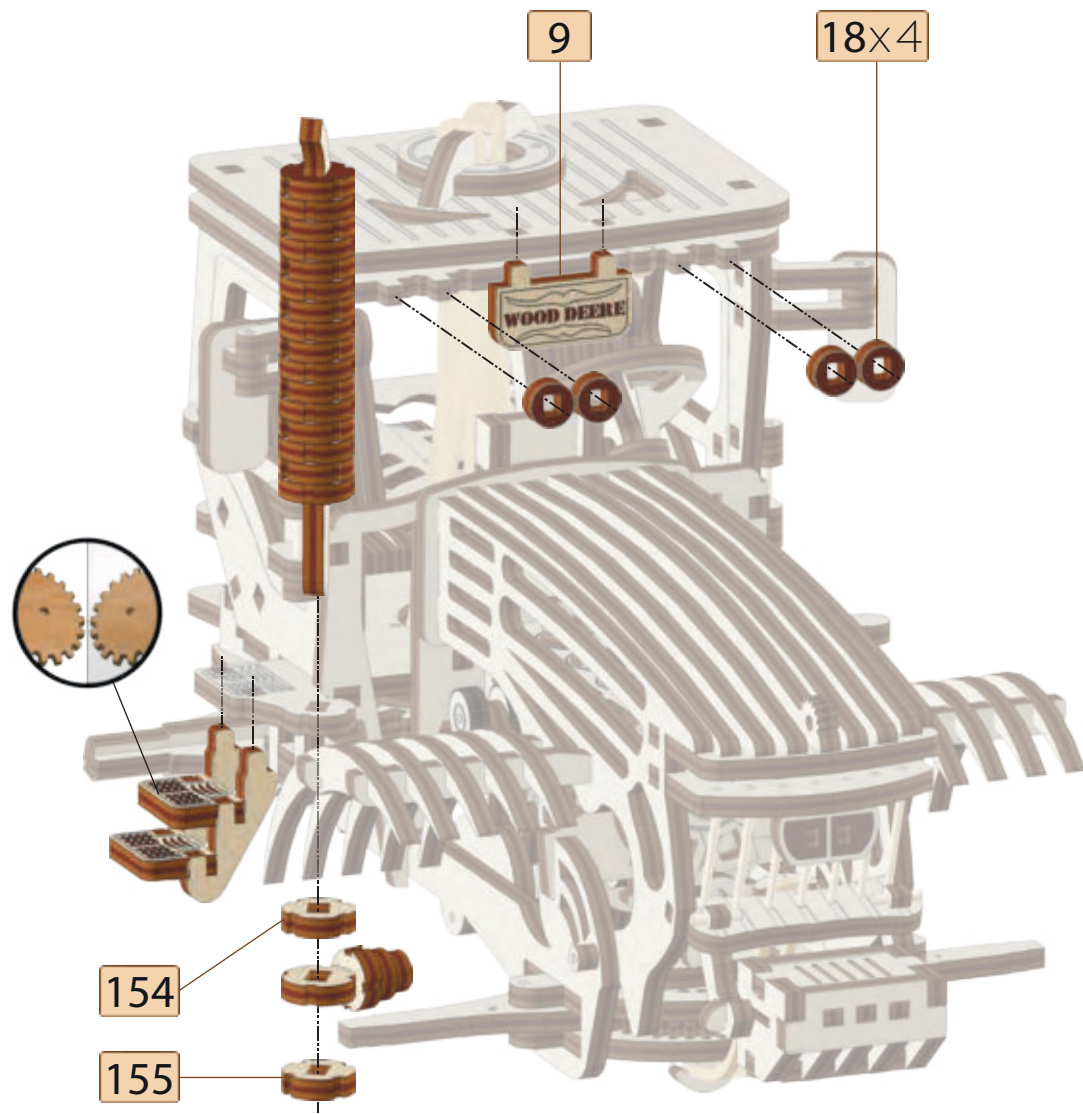
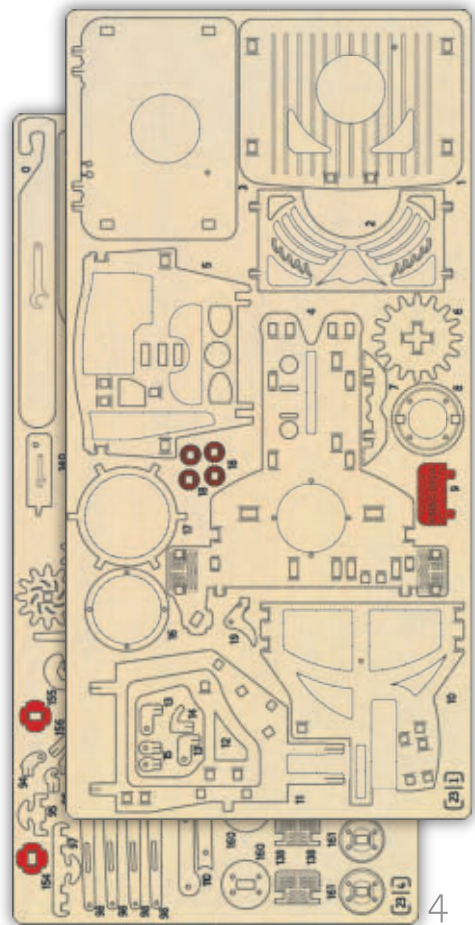

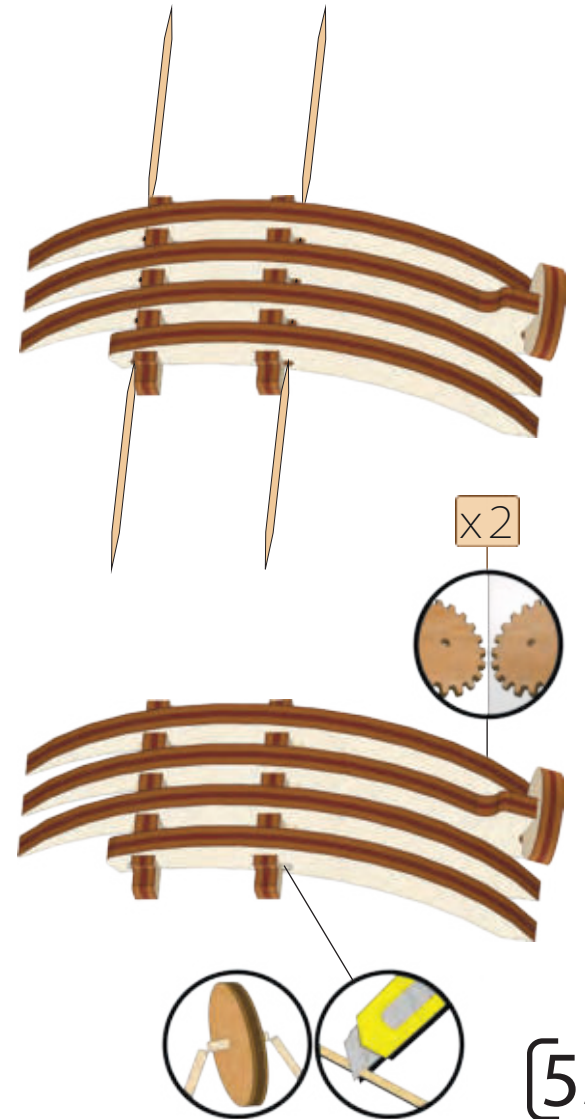
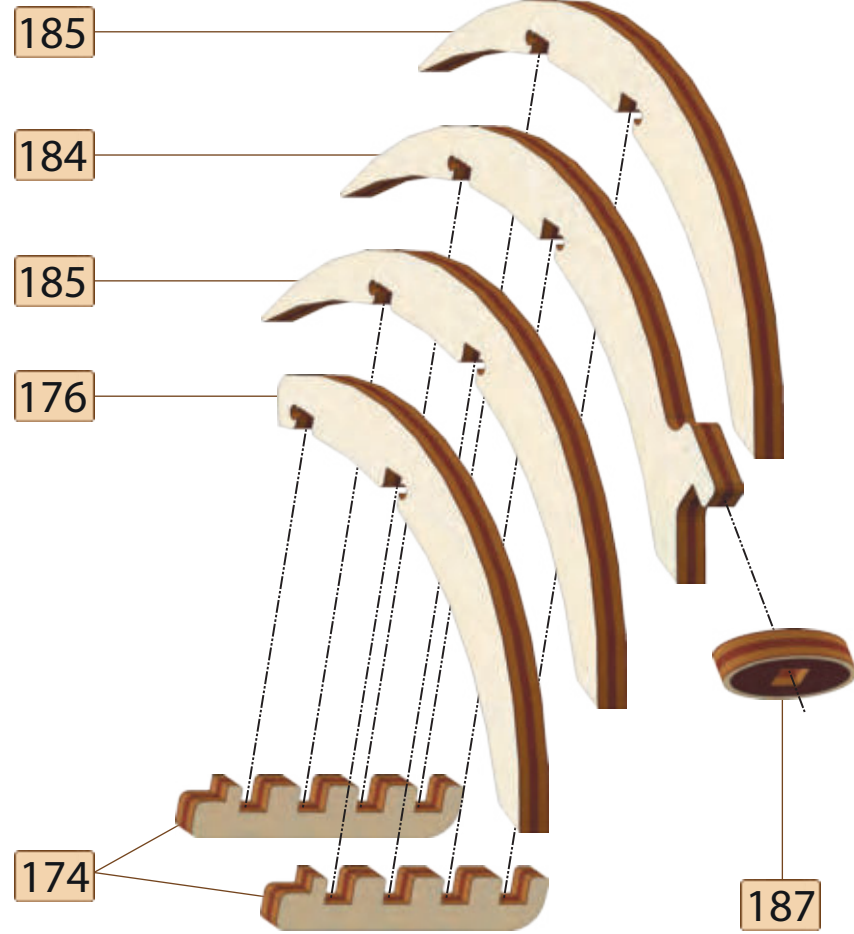
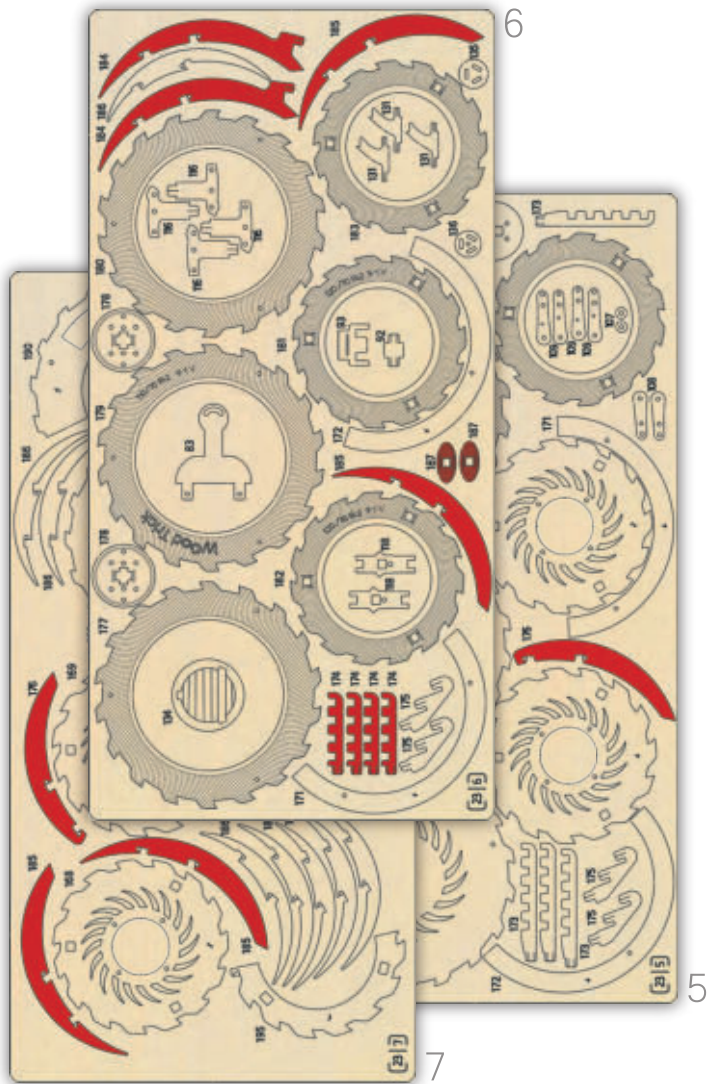



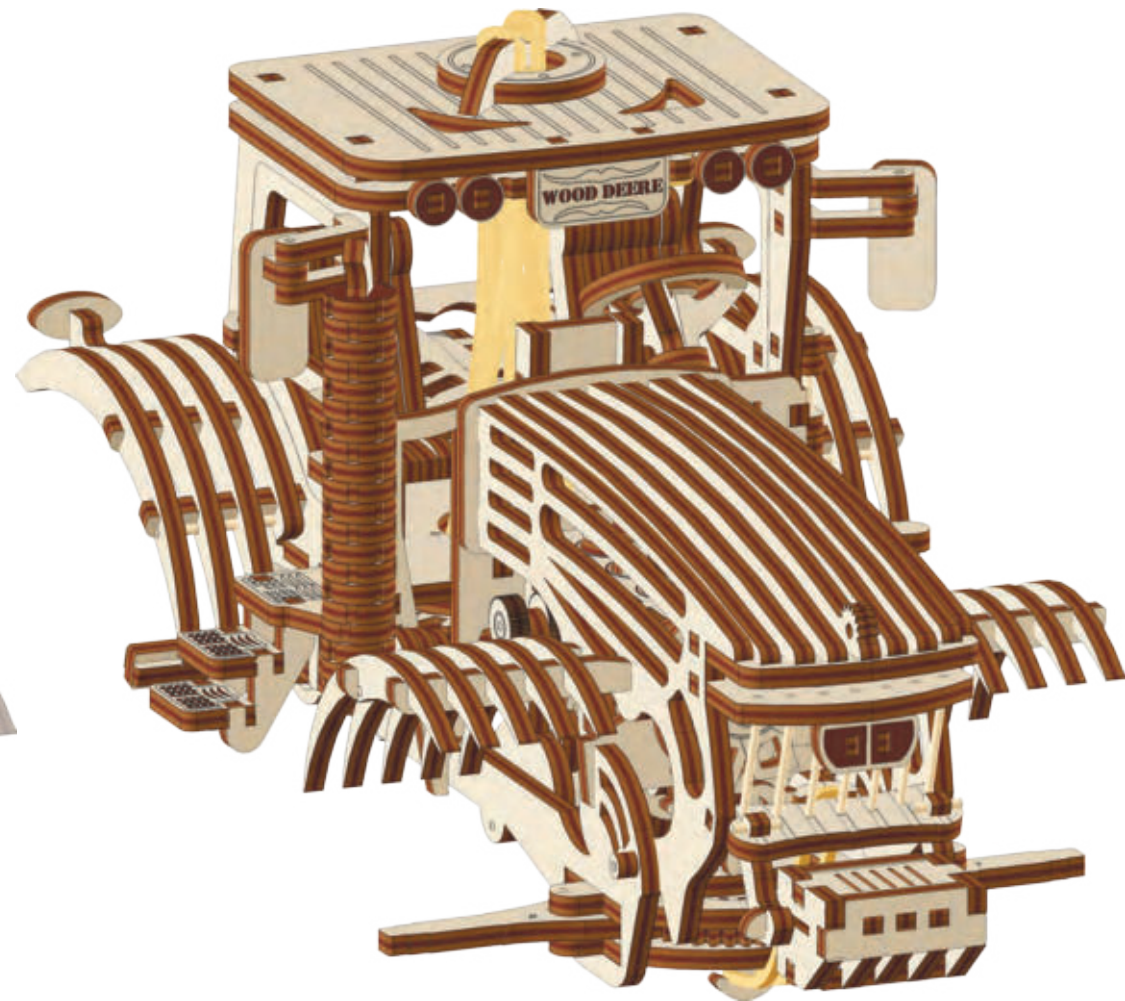
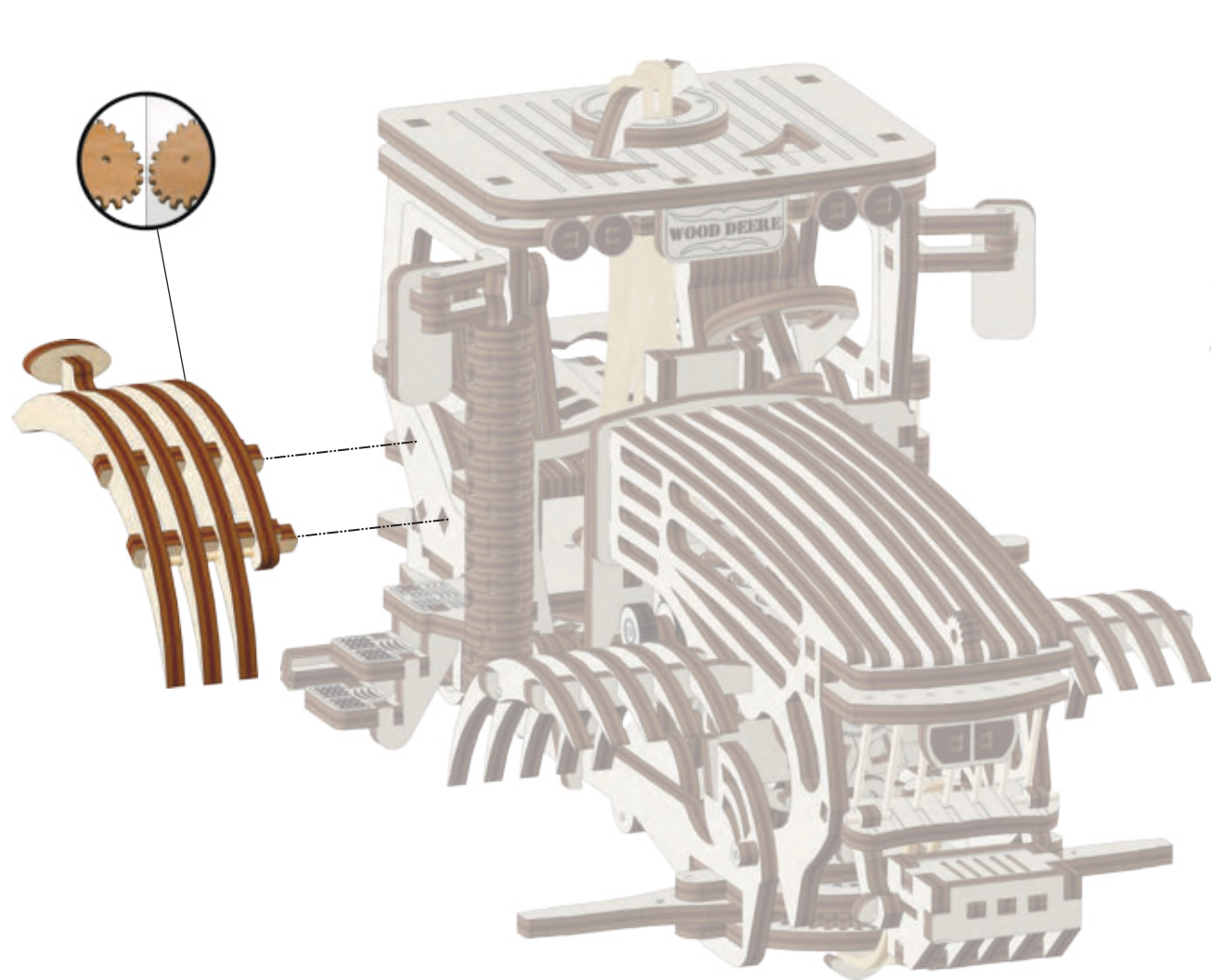

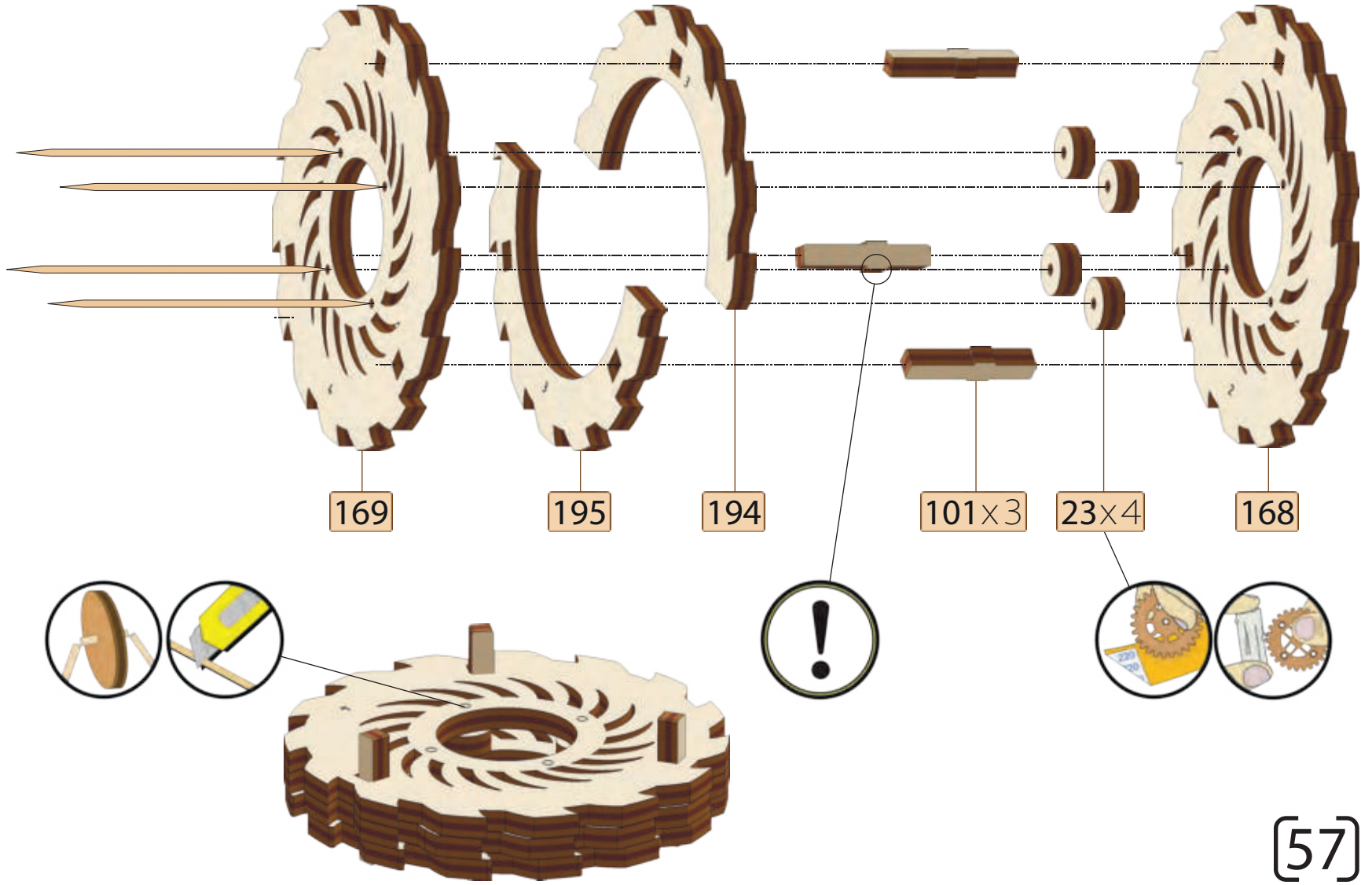

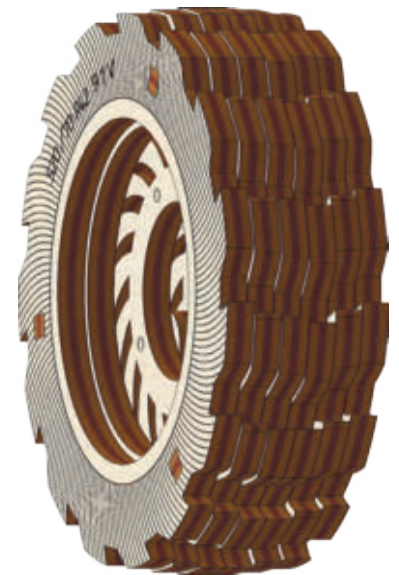
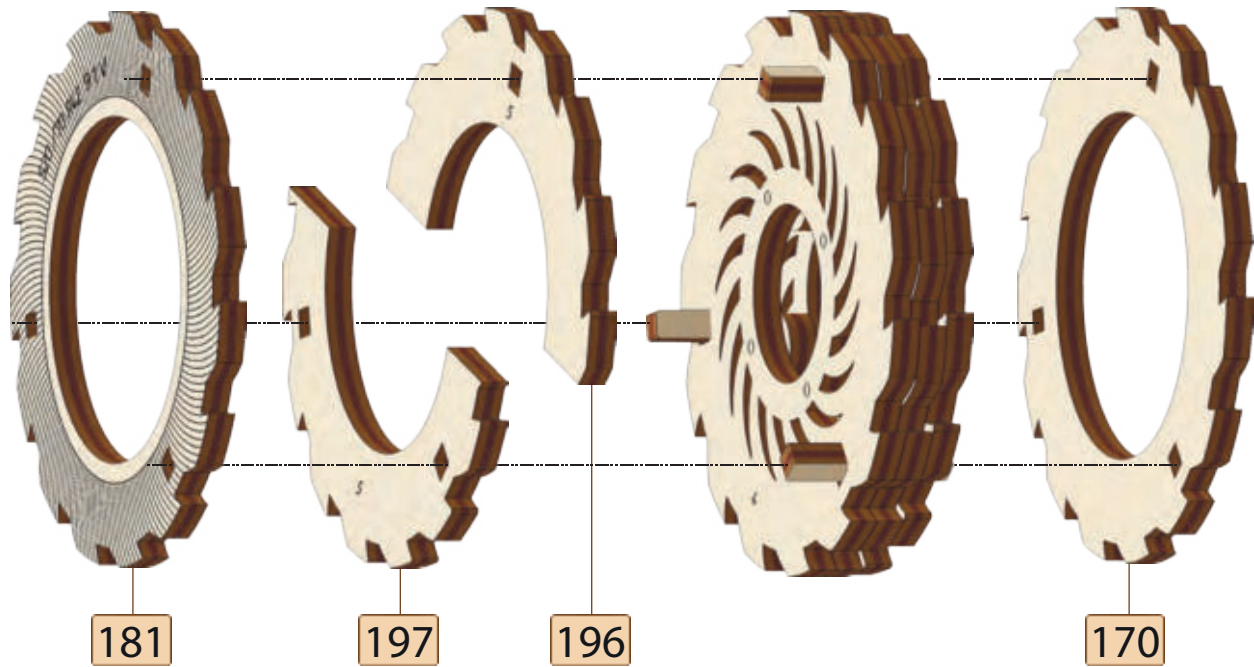

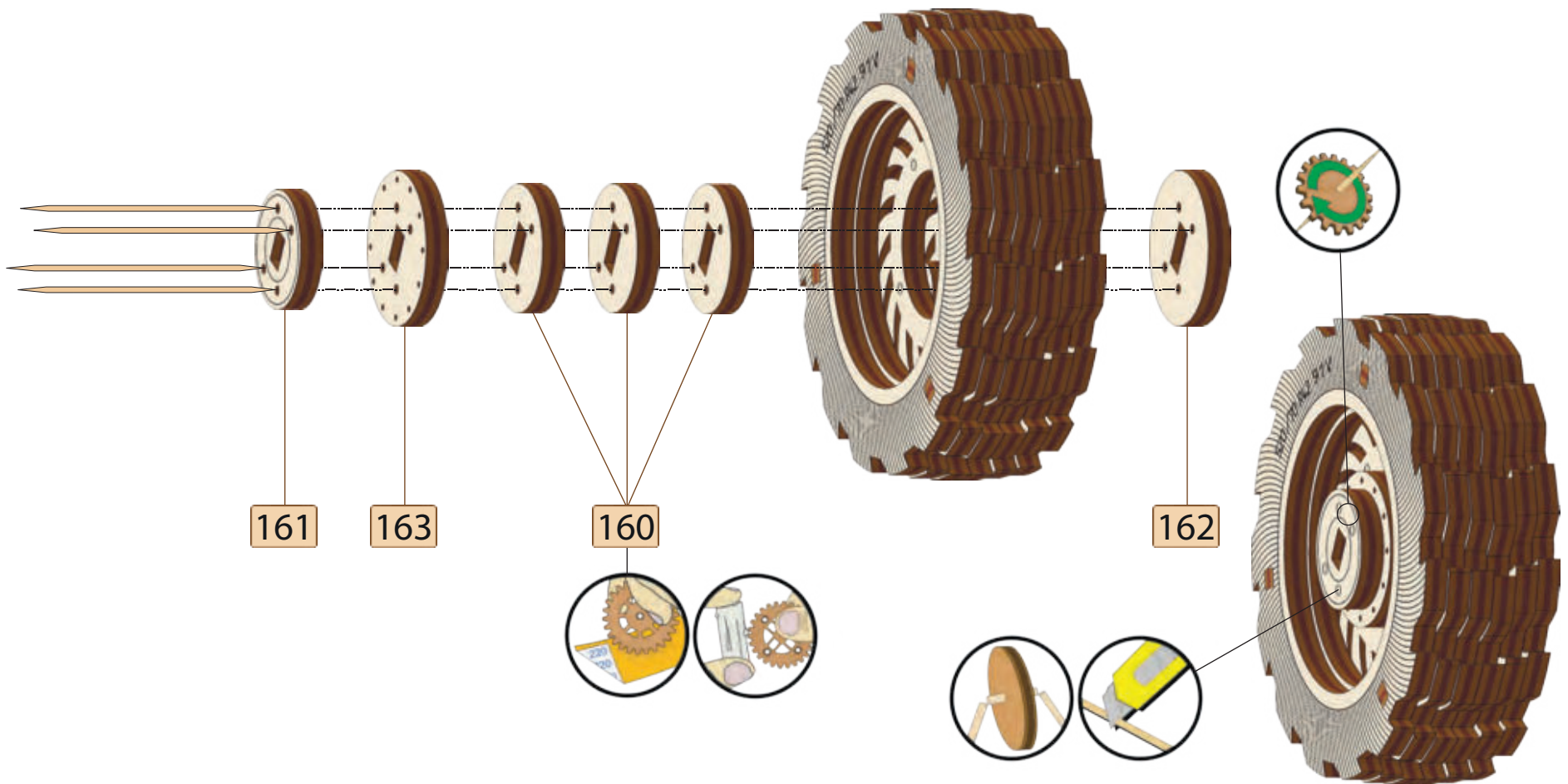
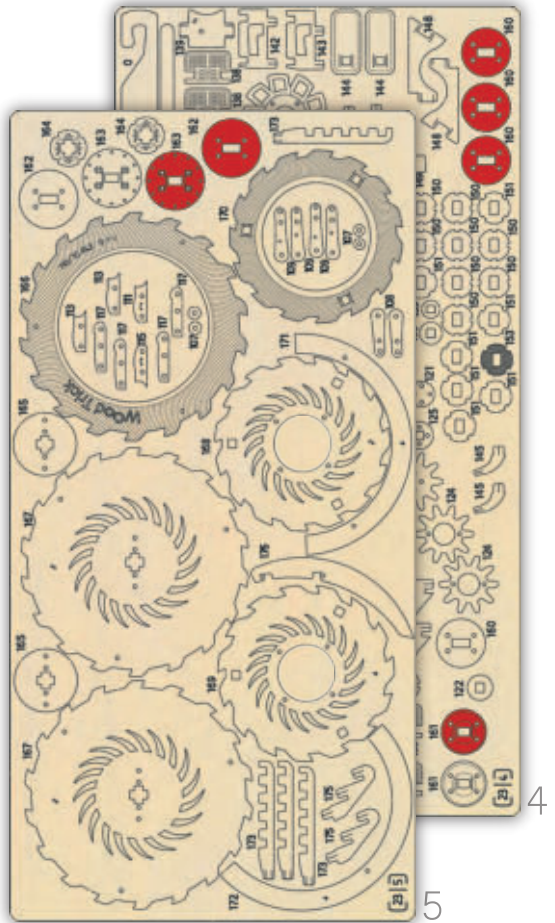

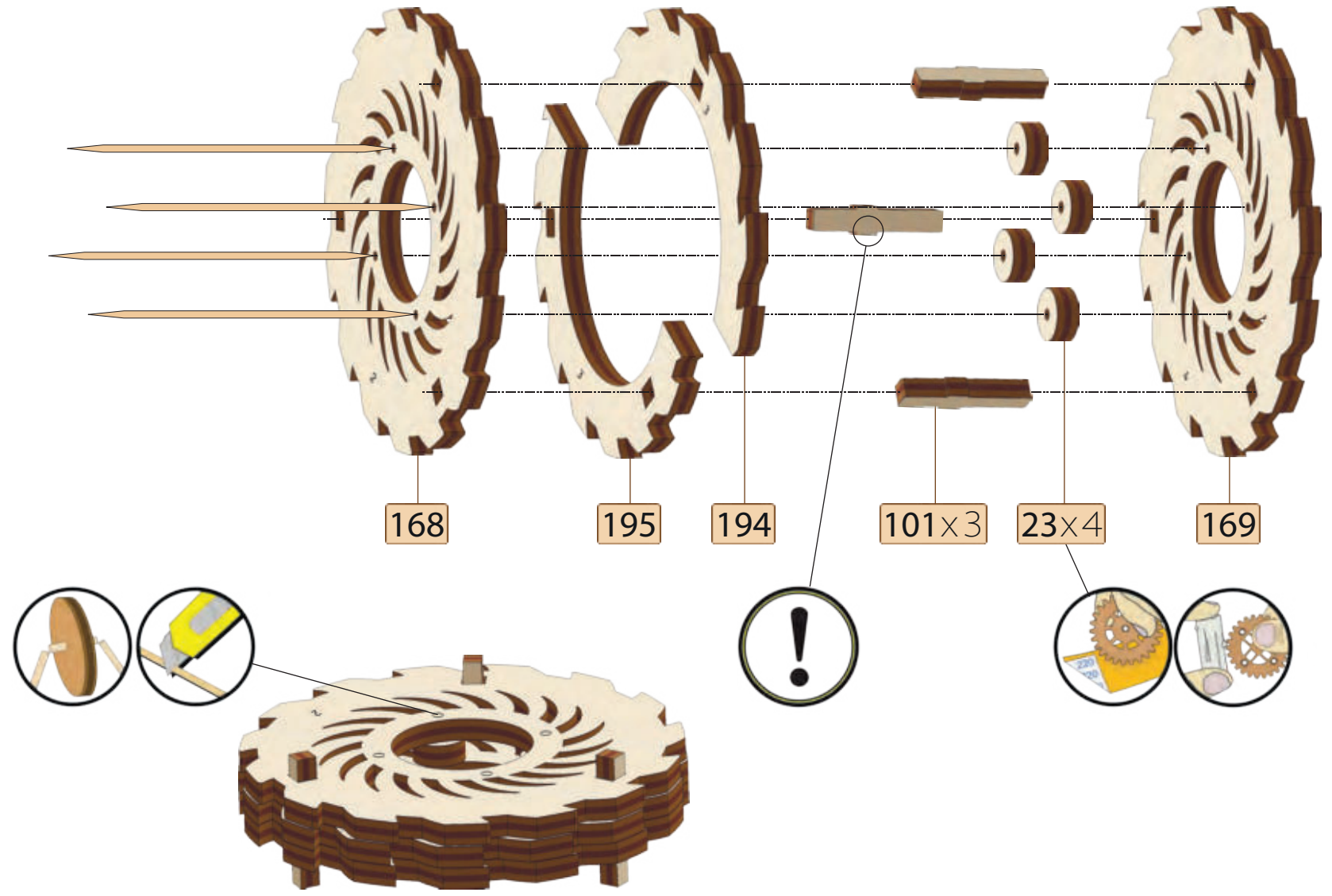

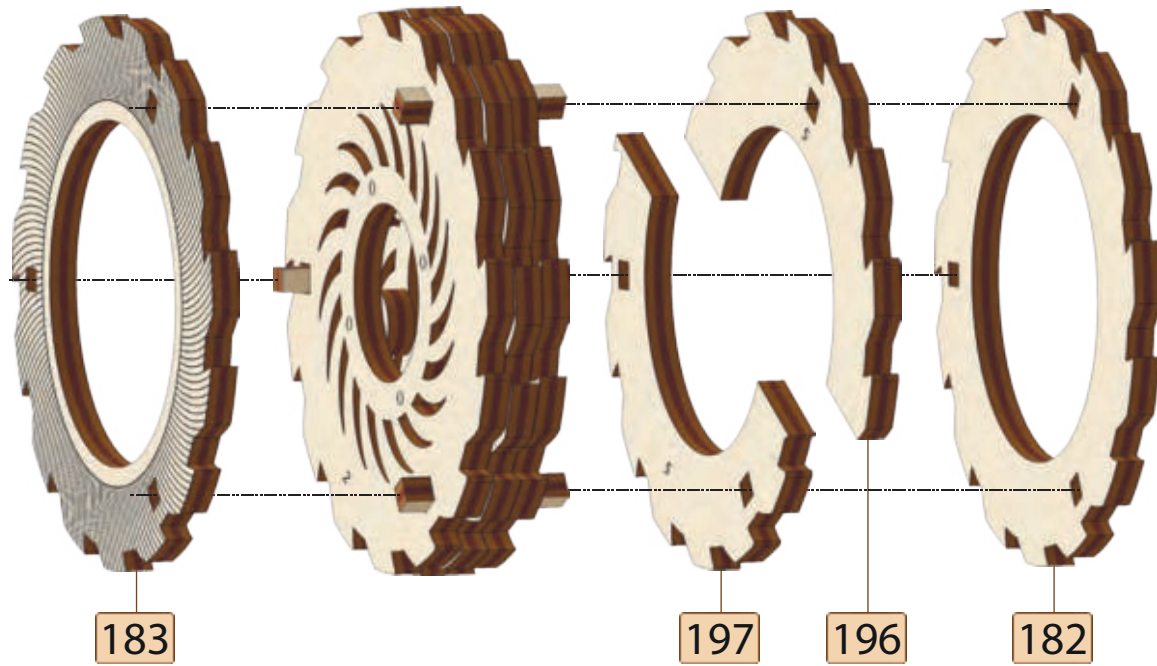
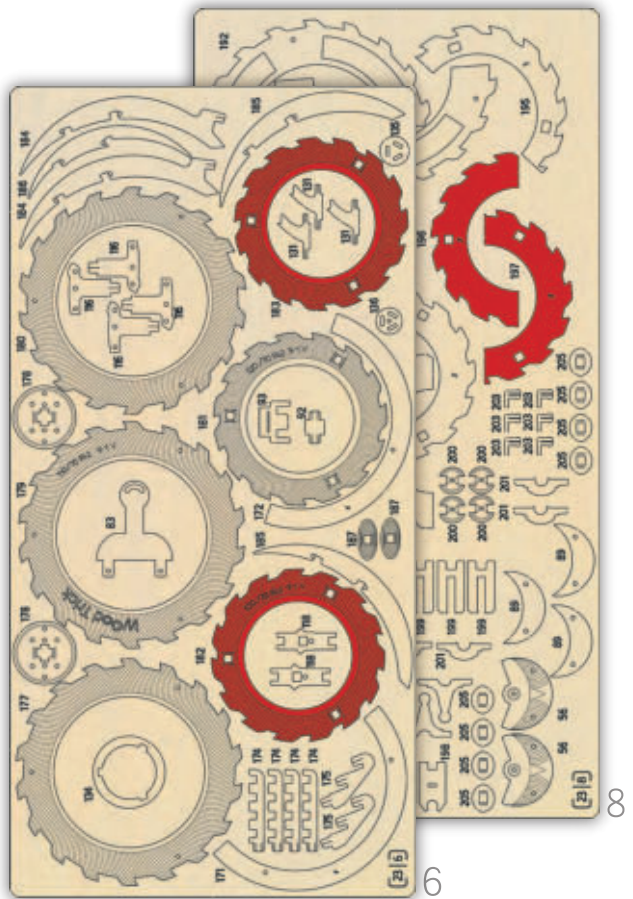

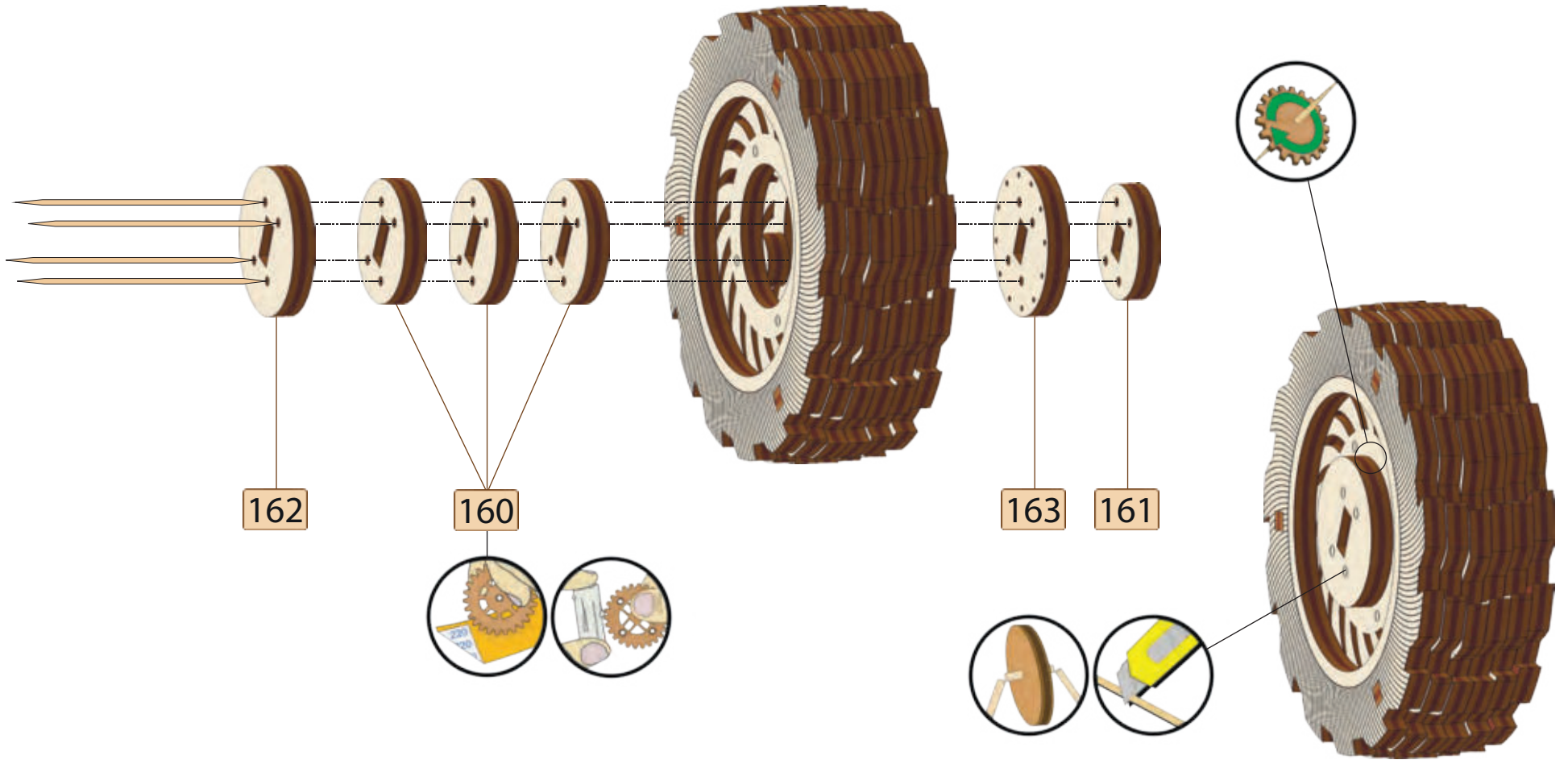
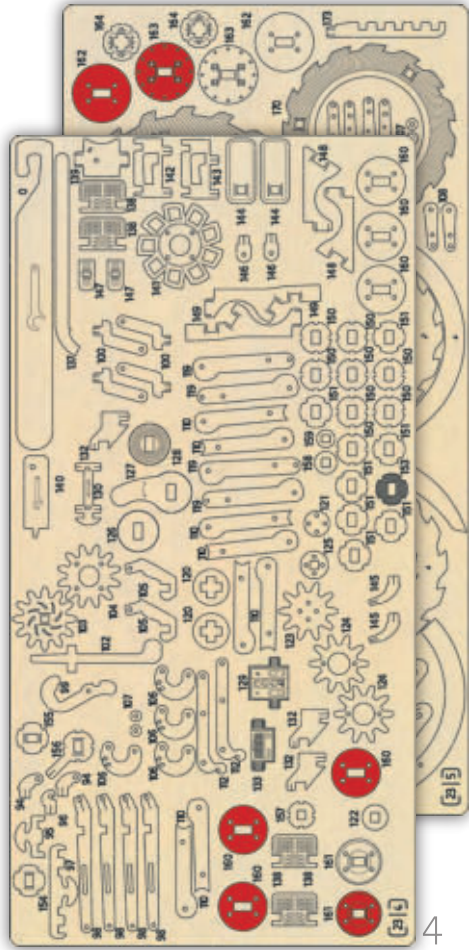

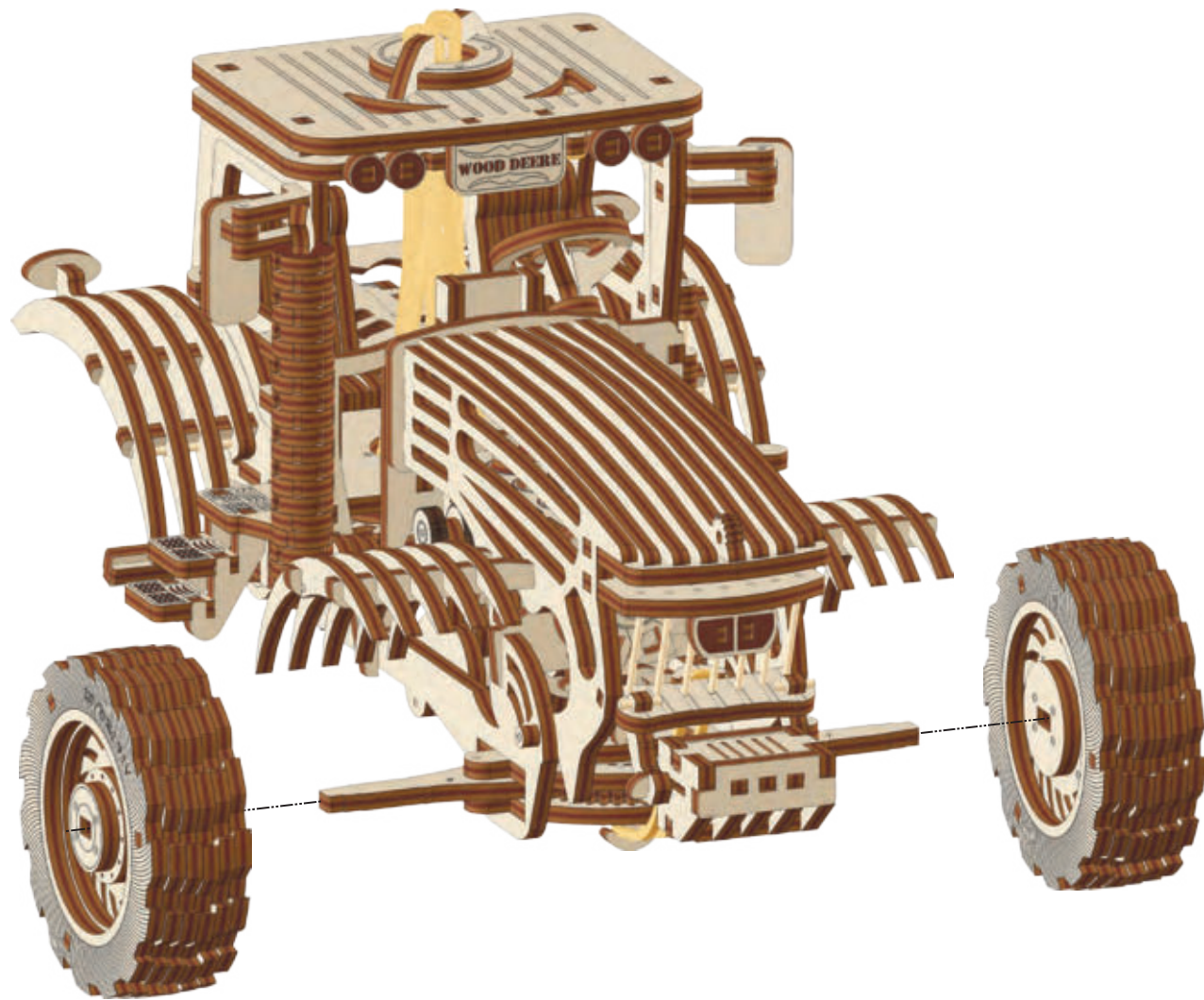



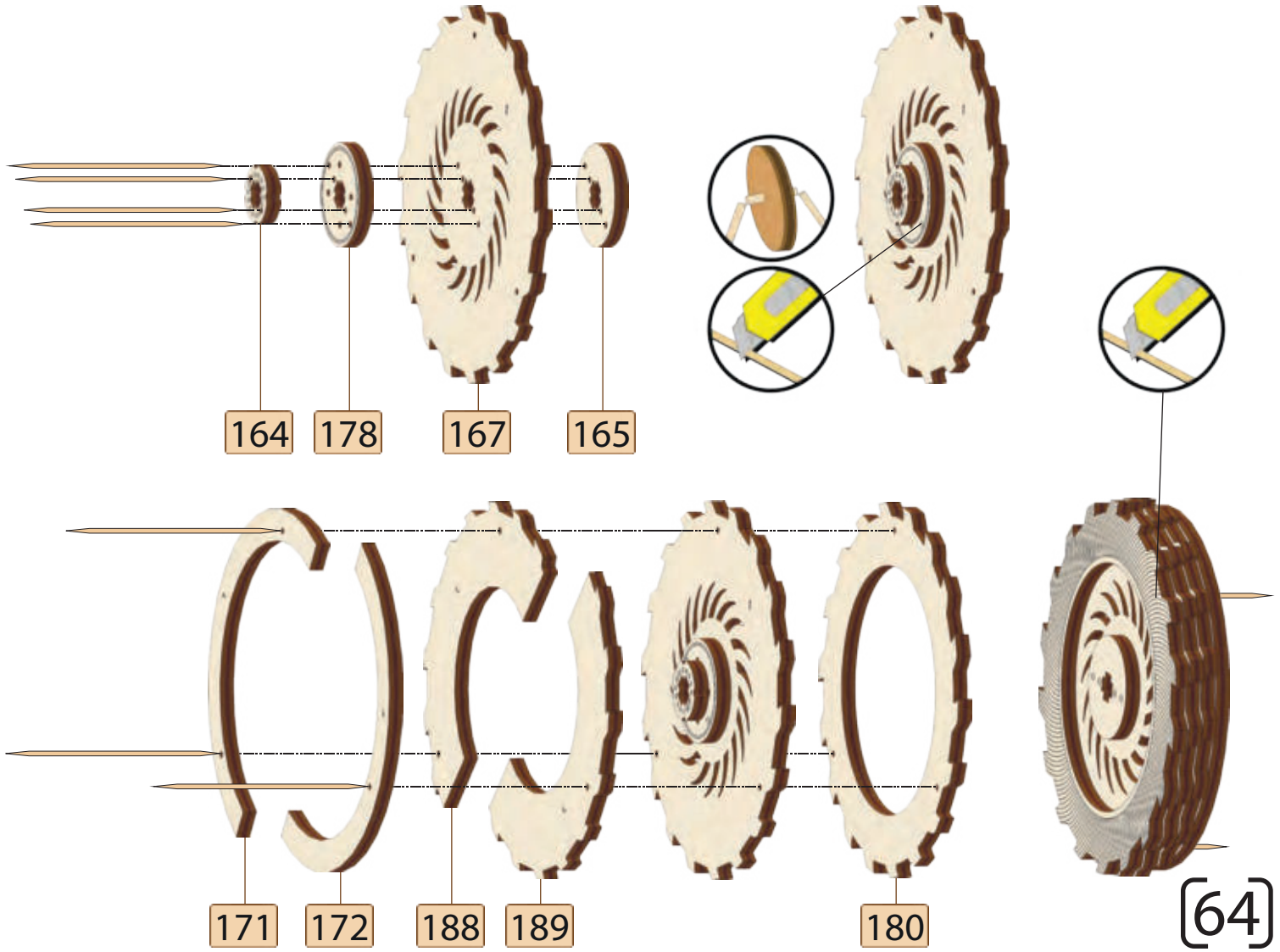

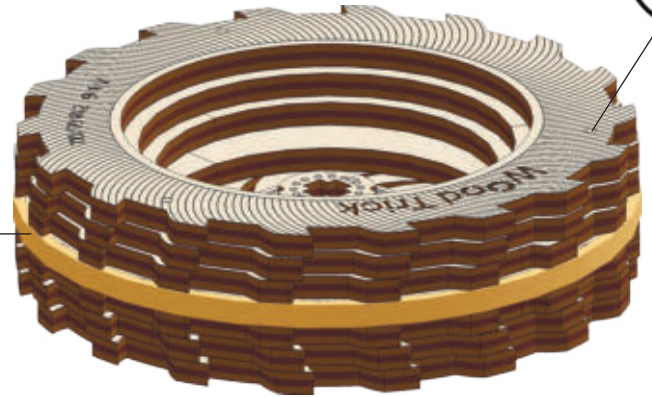
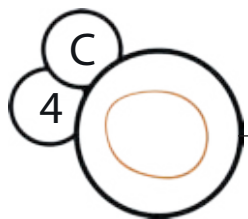
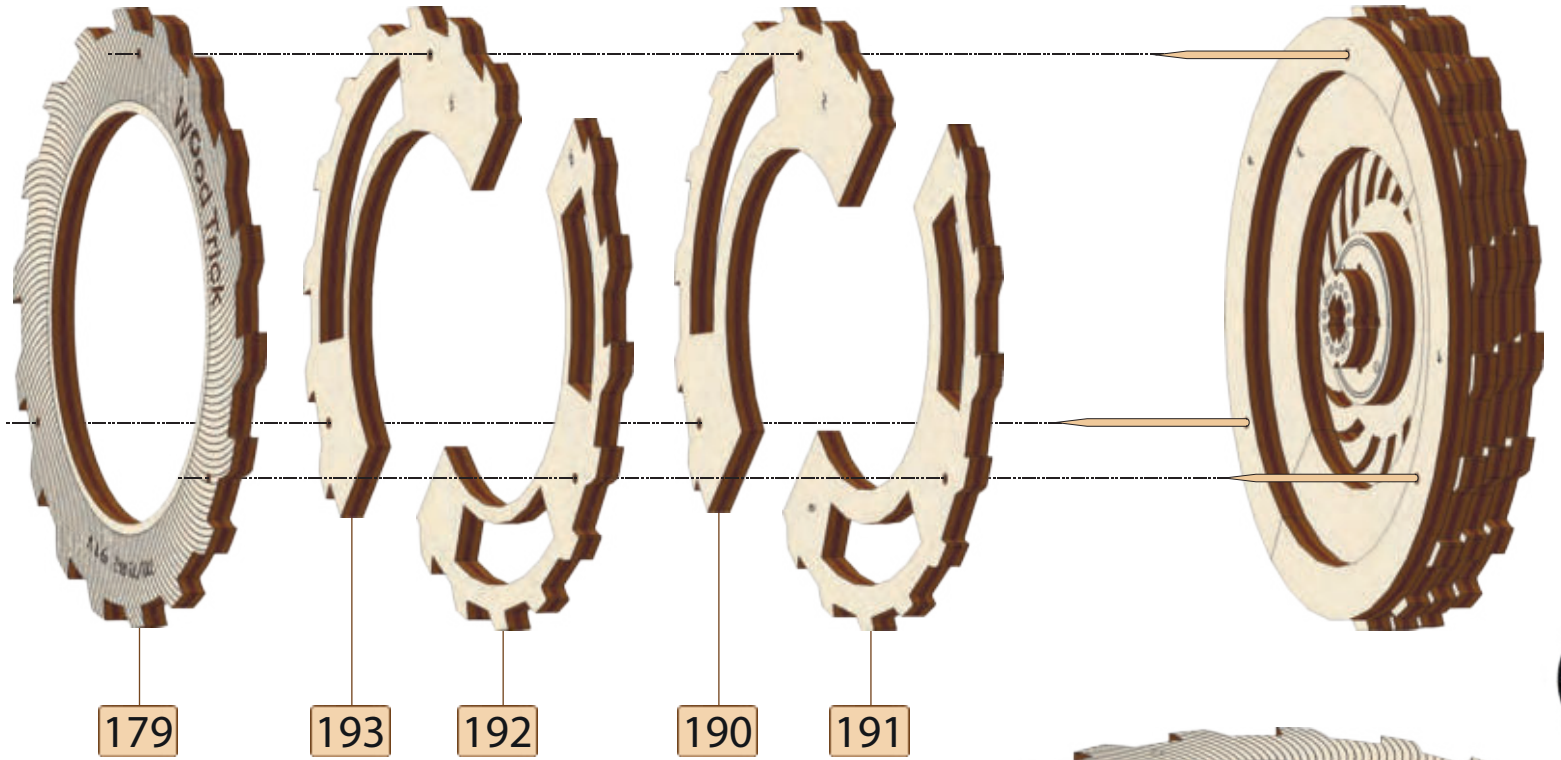
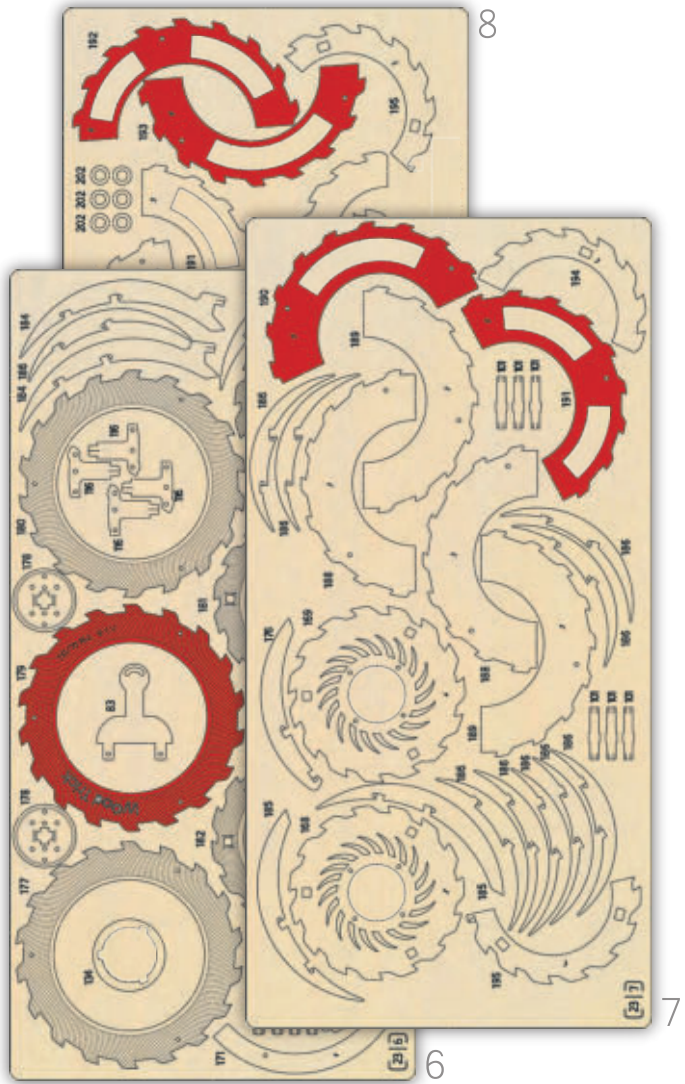

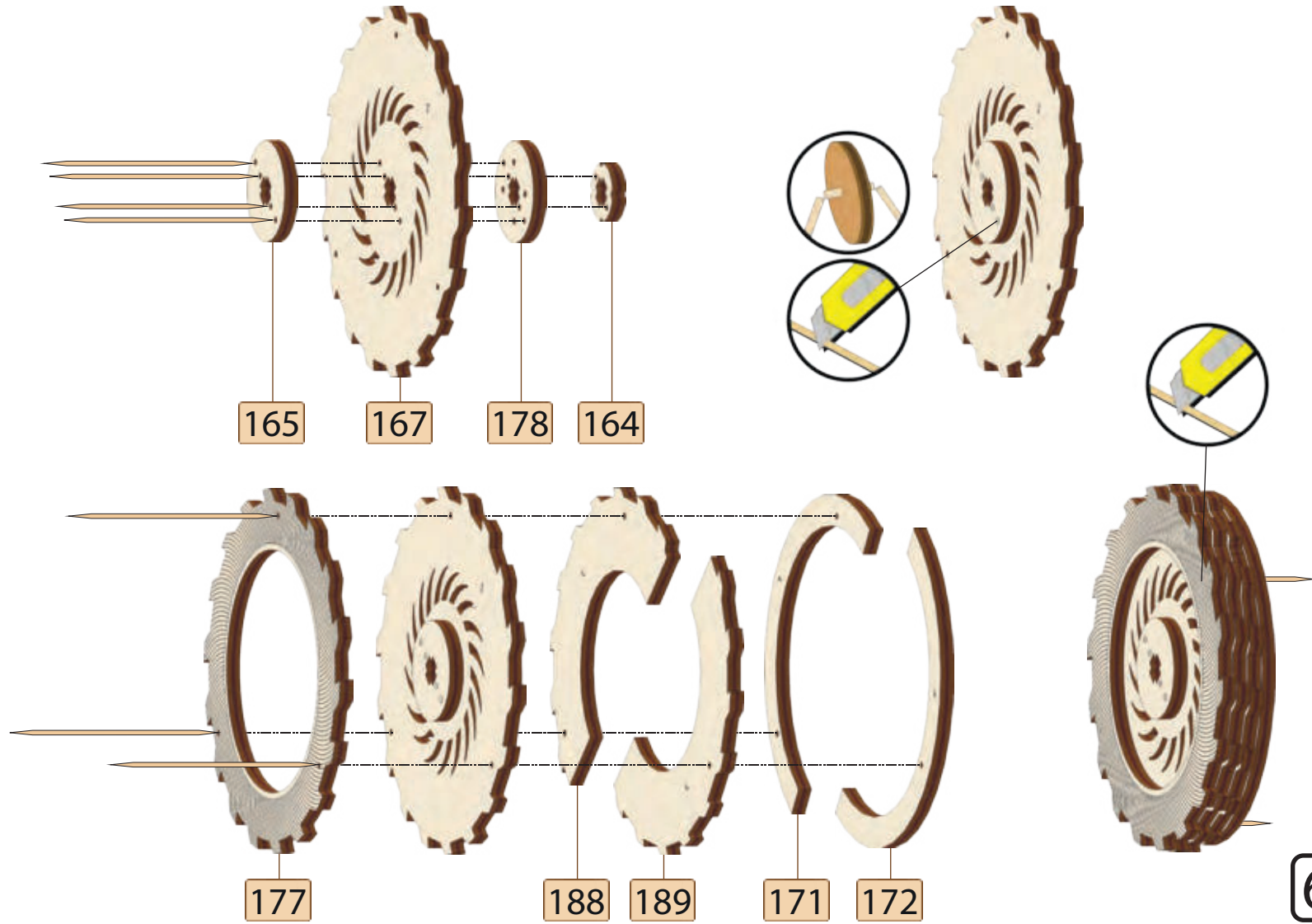

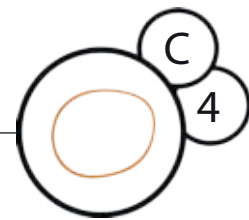
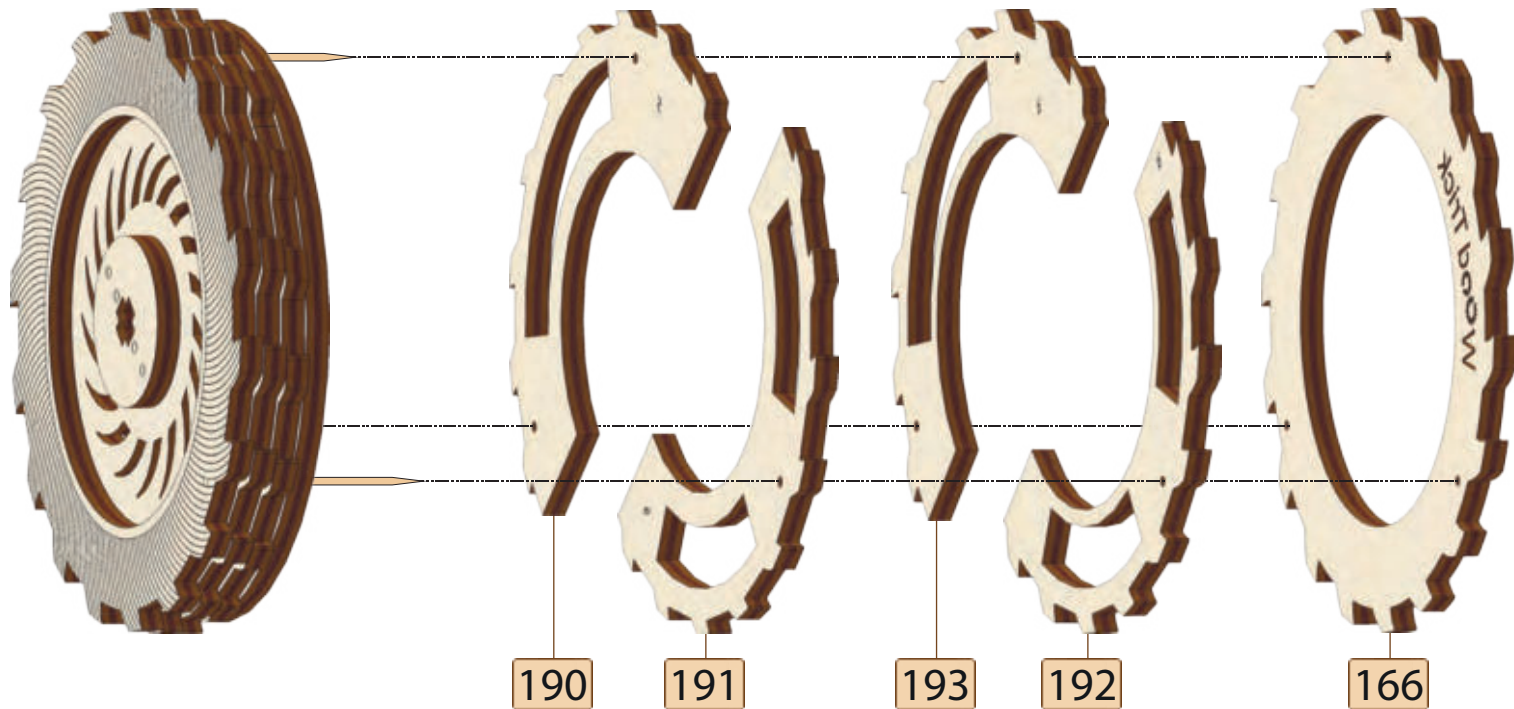

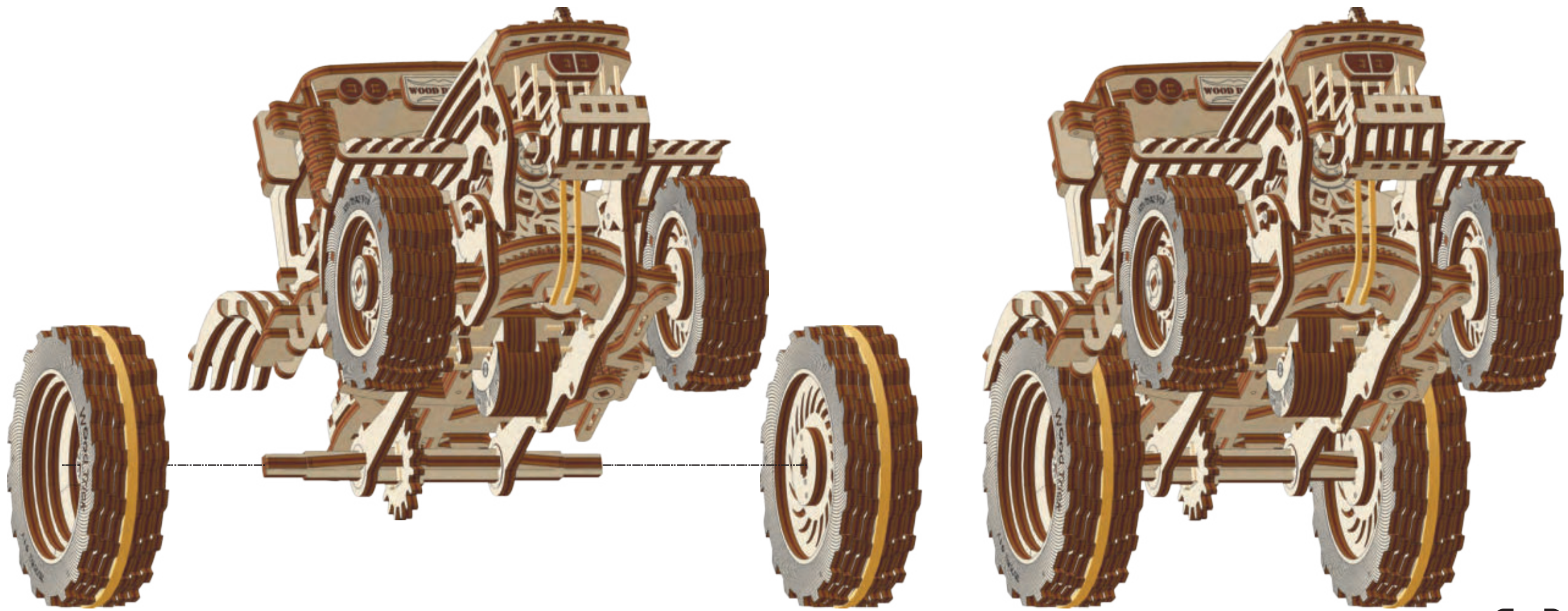

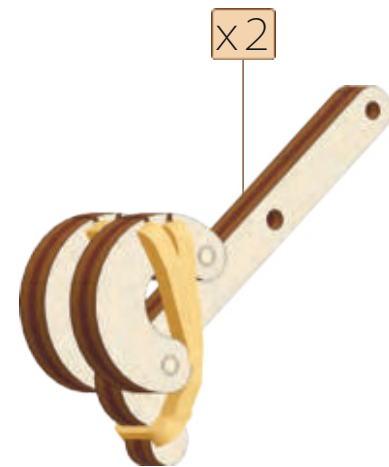
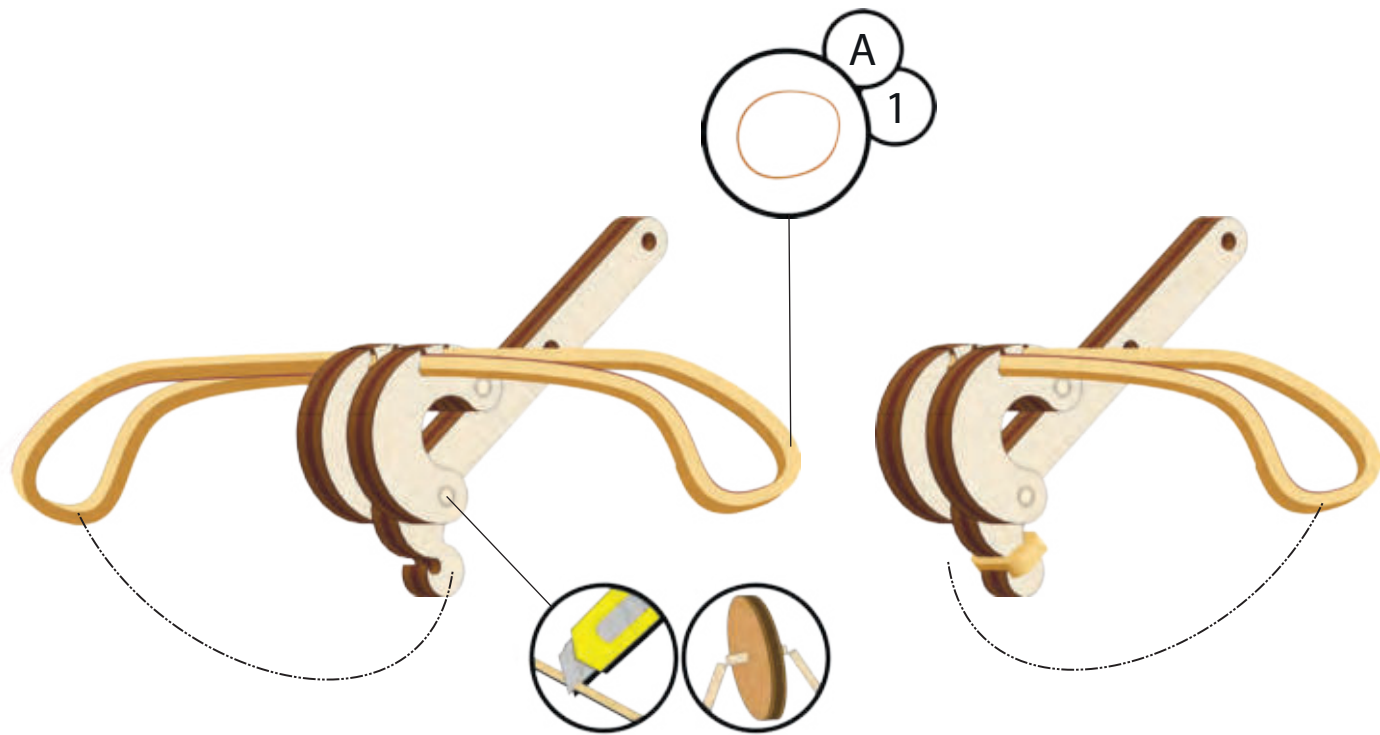
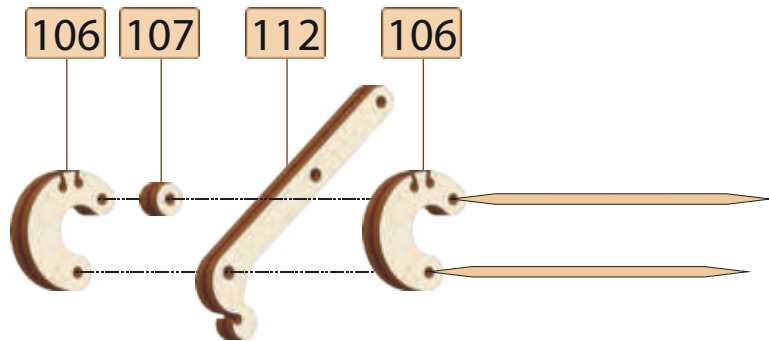

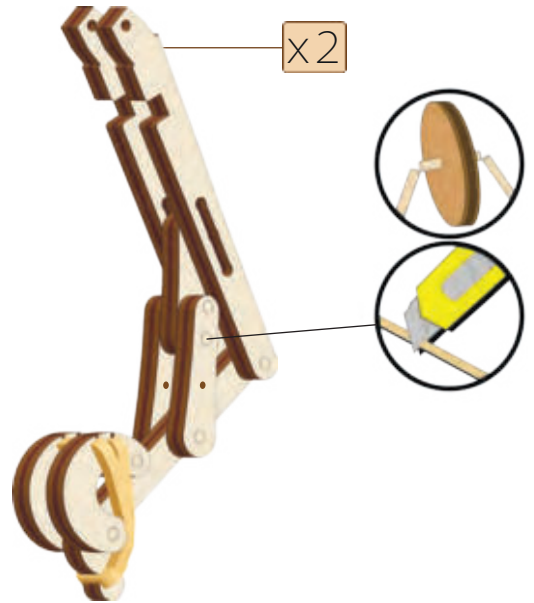
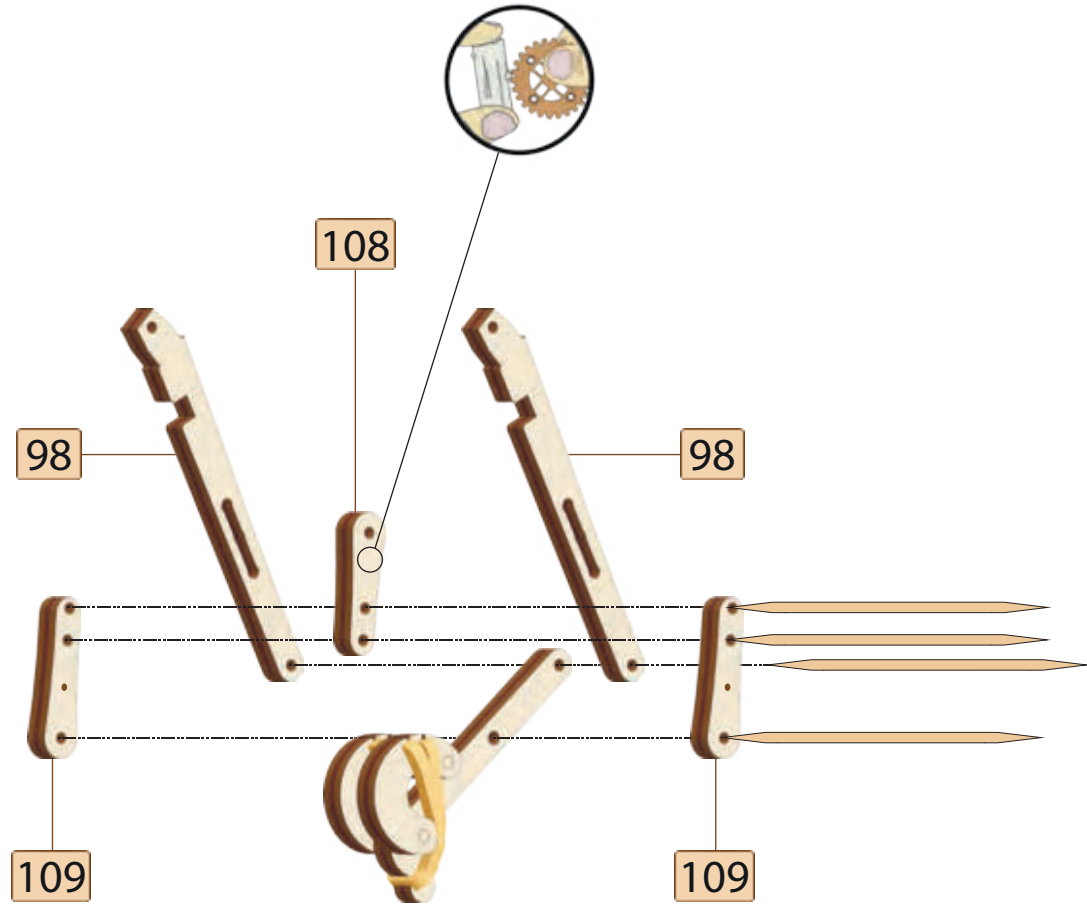
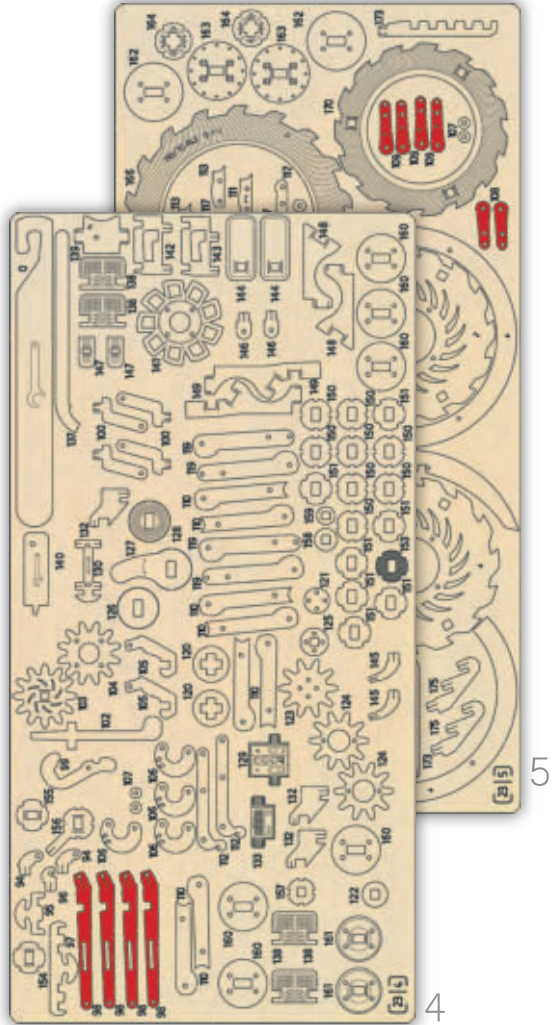

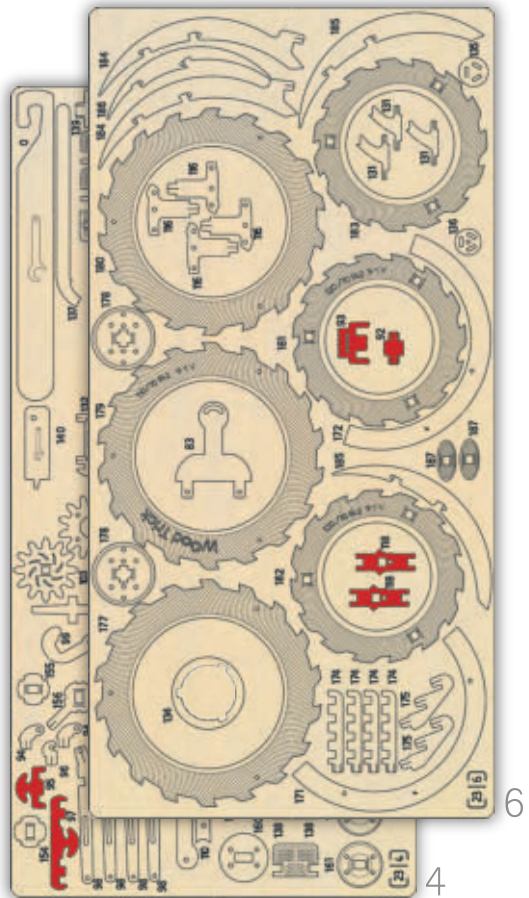

6

4

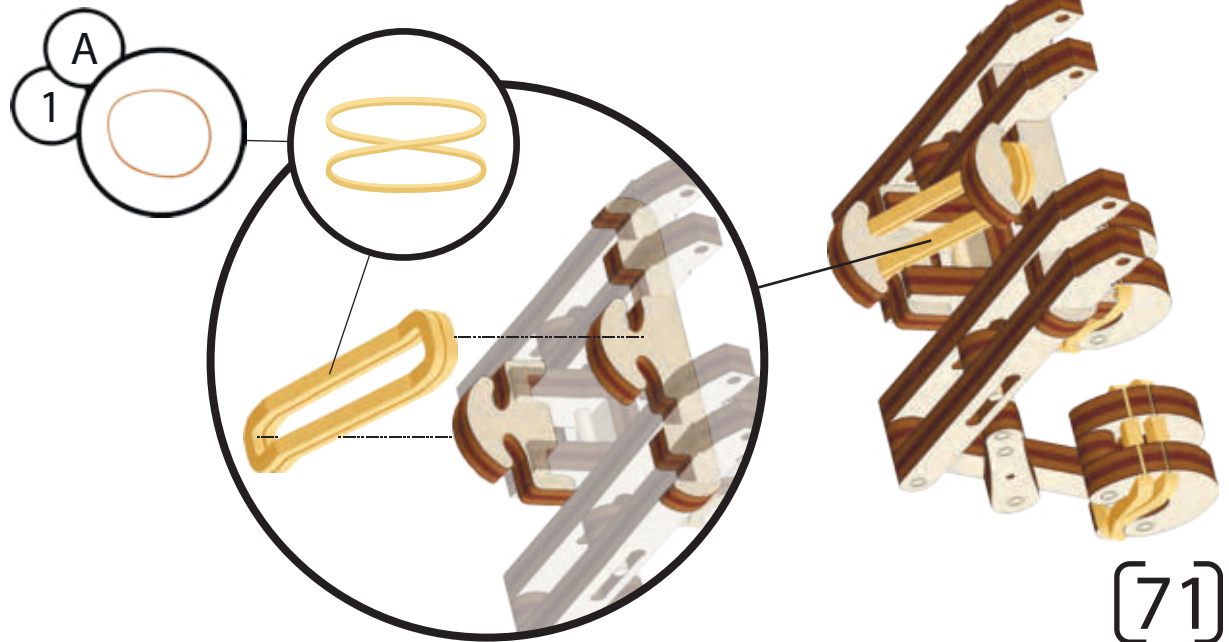
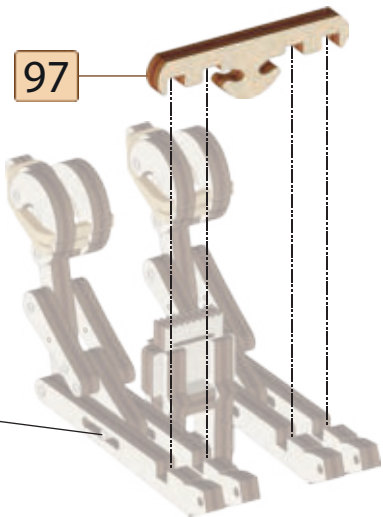
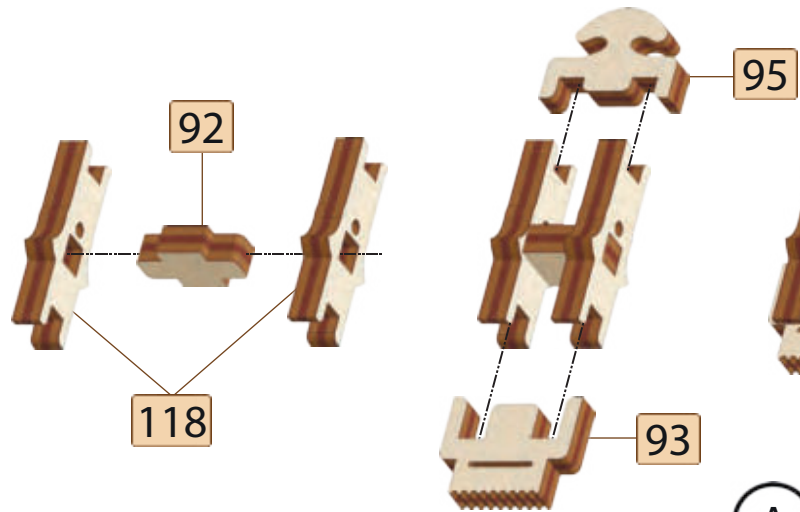

[71]



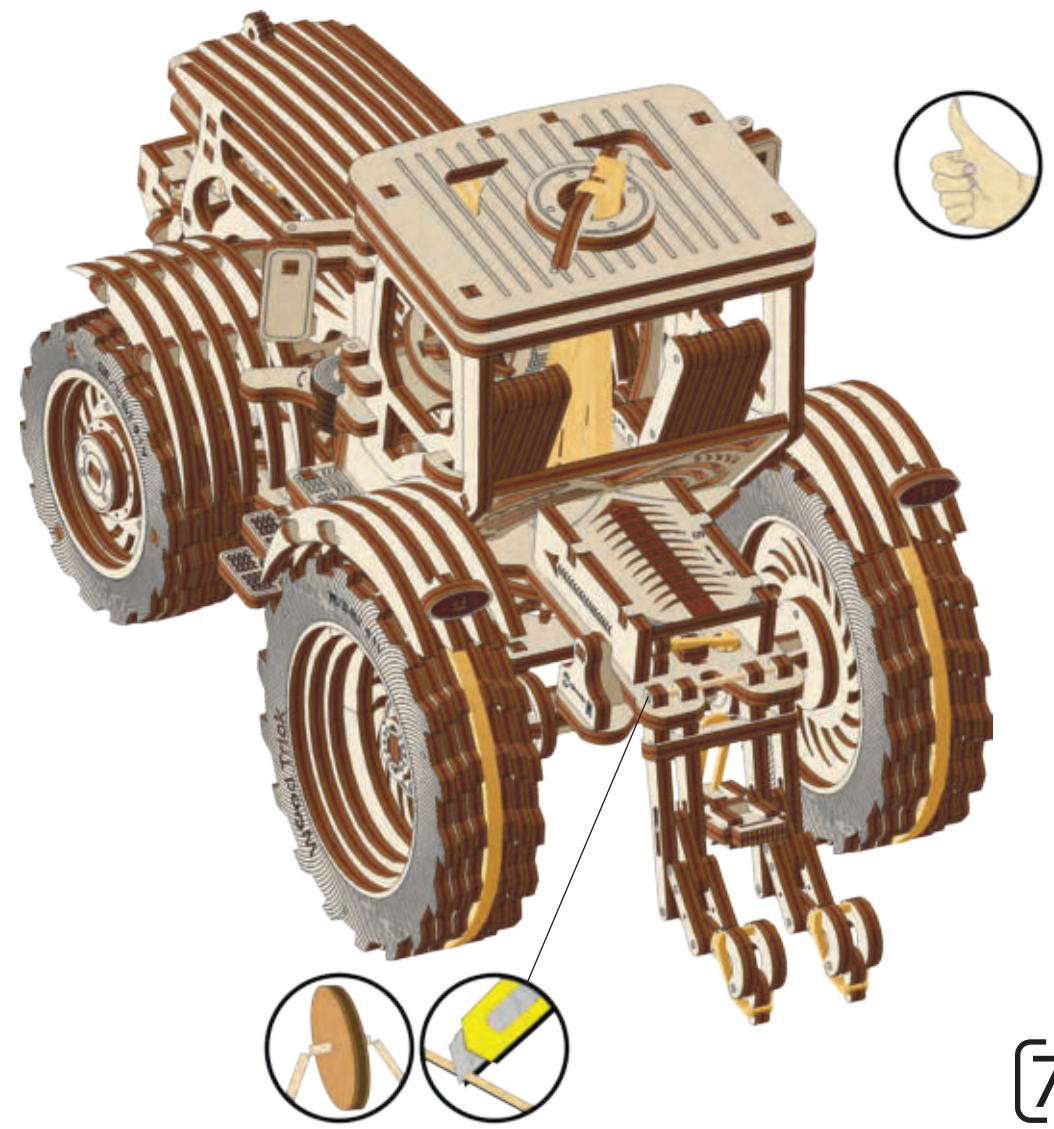
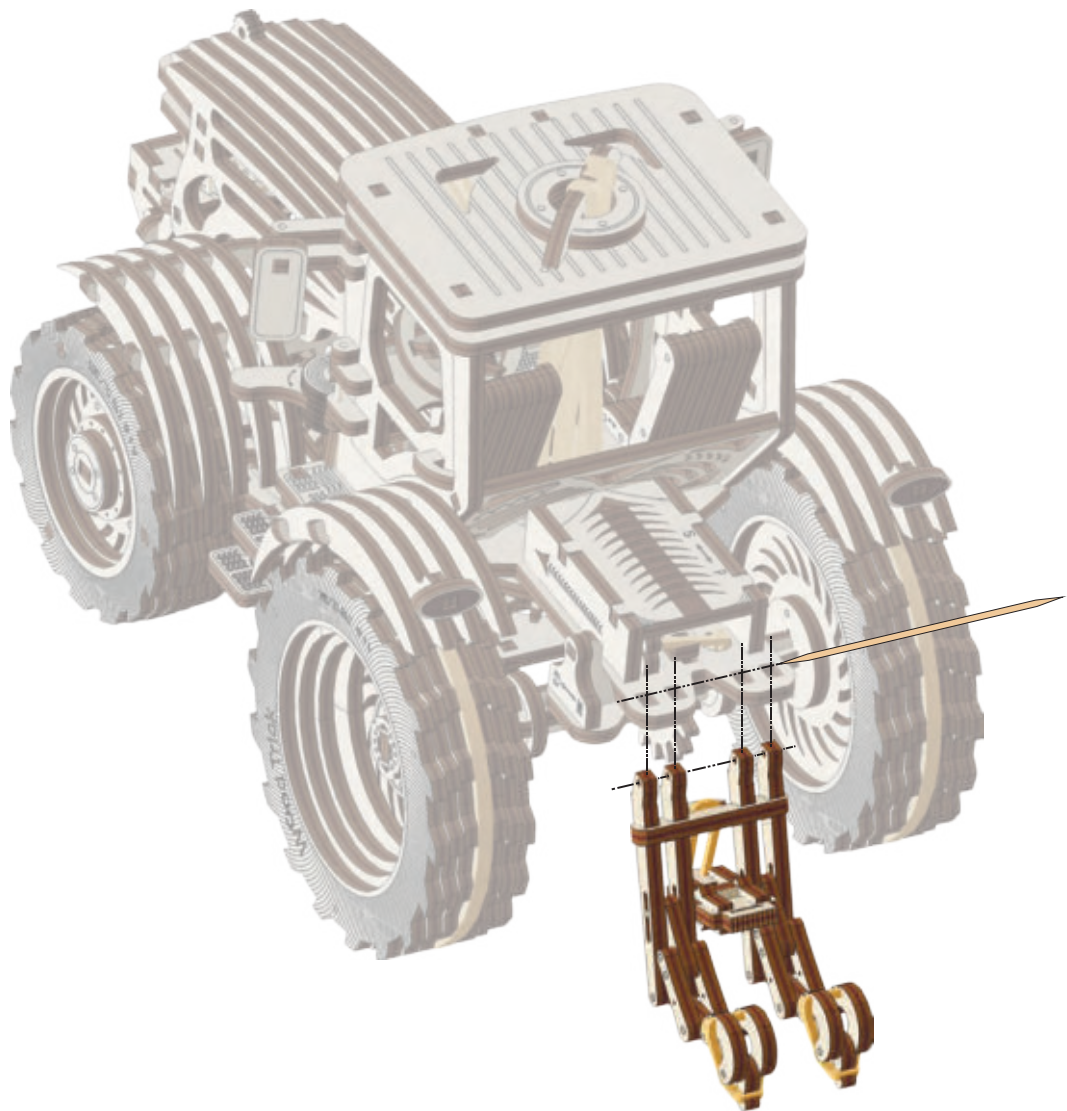

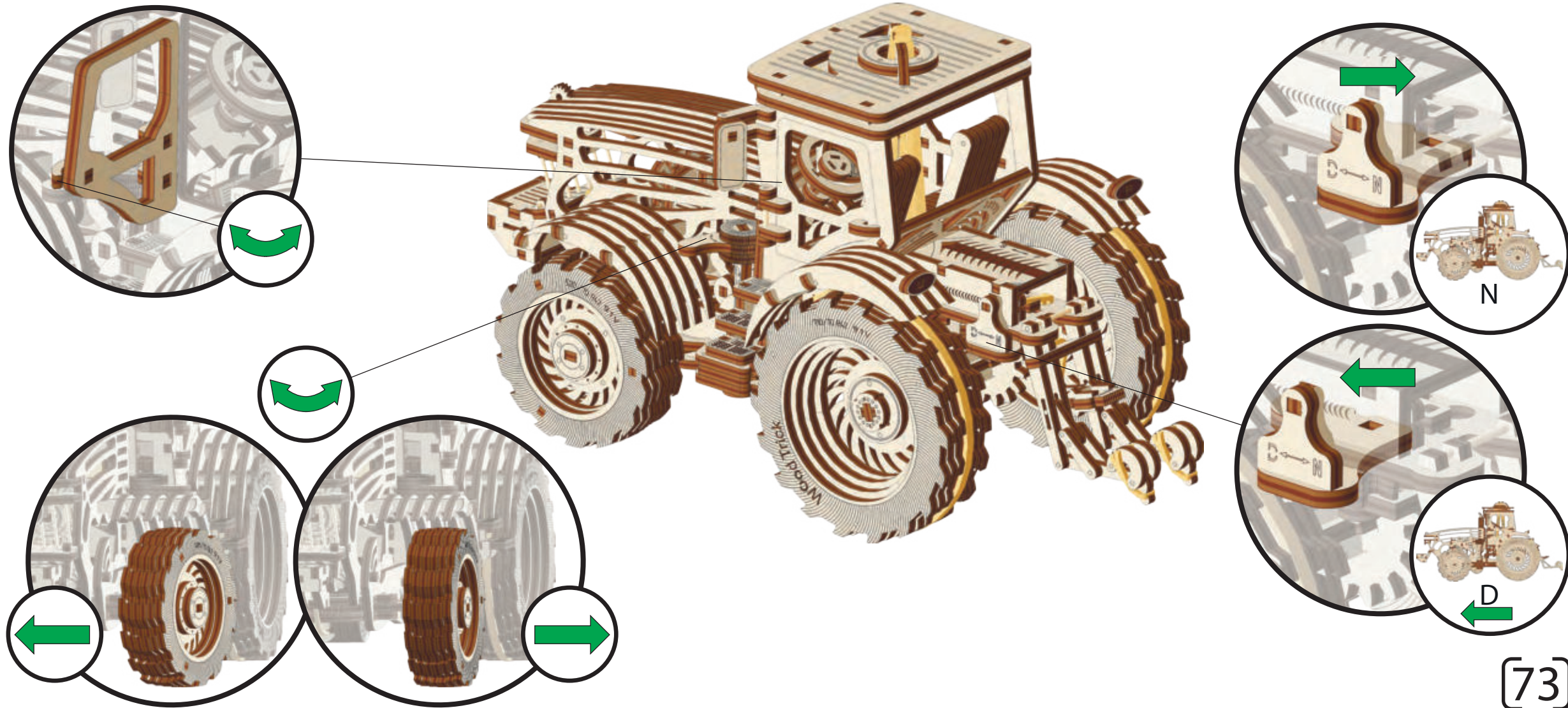

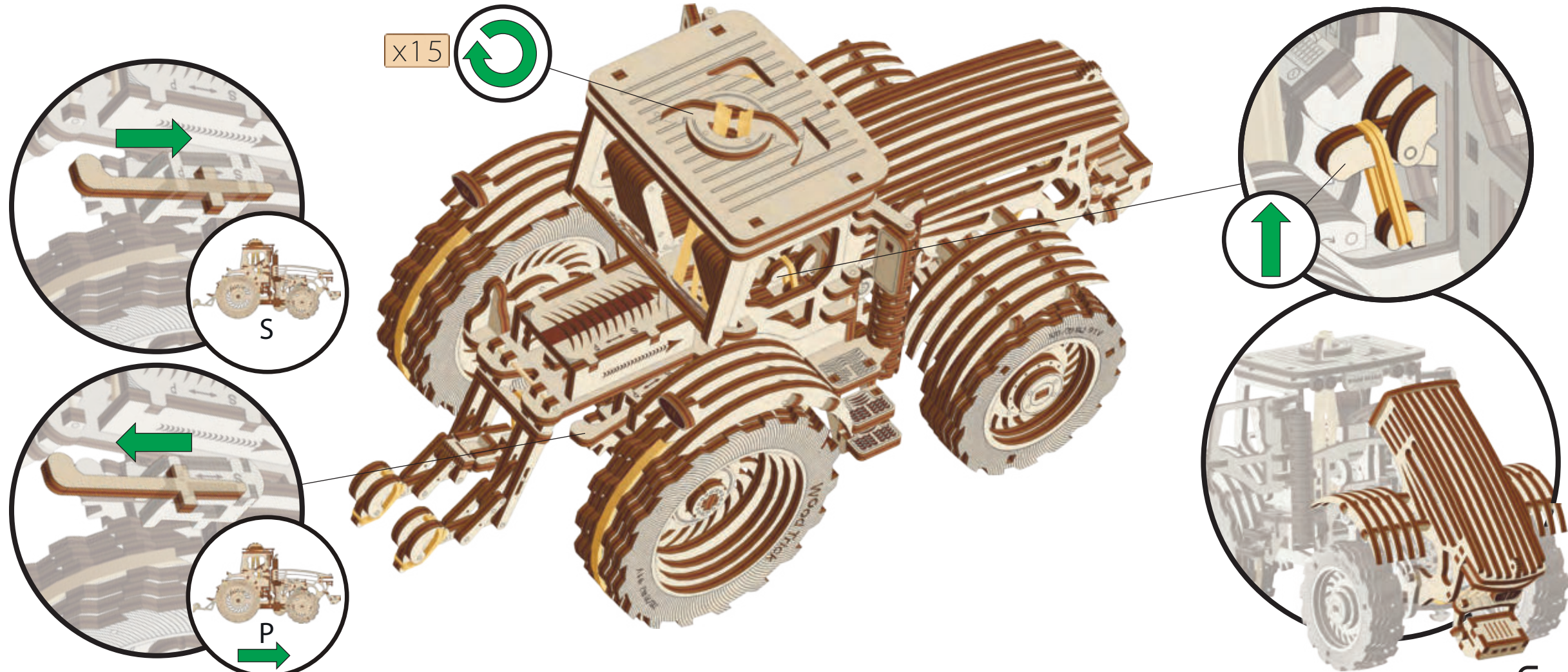

x15



S

P



COLLECT A SET OF ADDITIONS

