



# MARVEL SUPER HEROES



76036





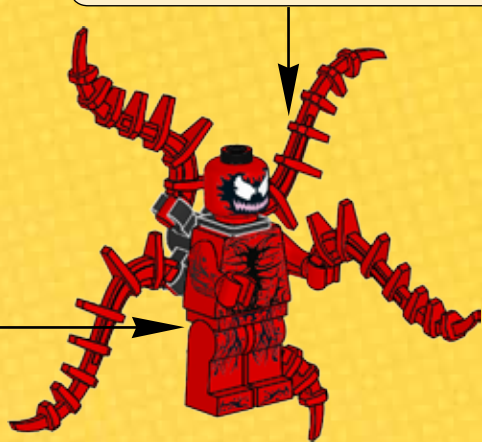
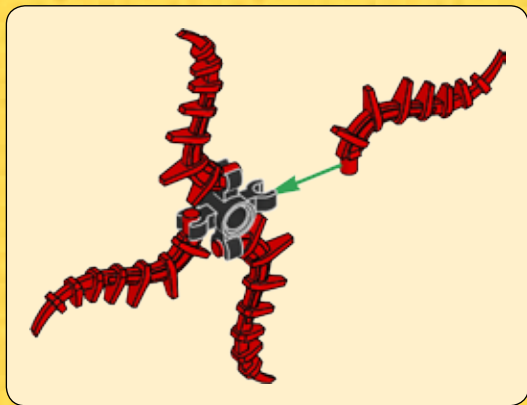
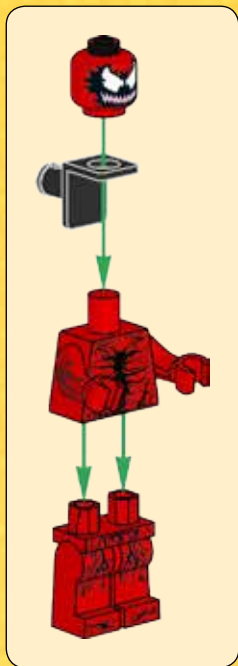

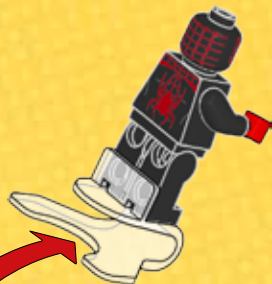
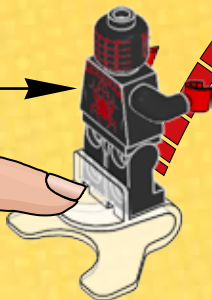
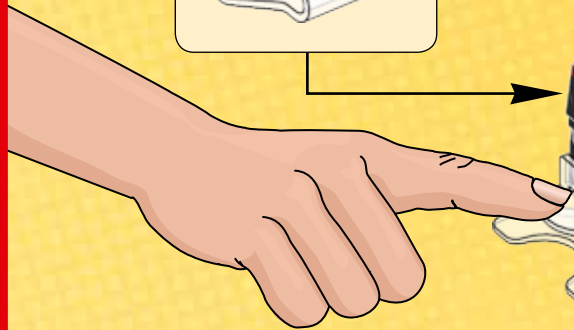
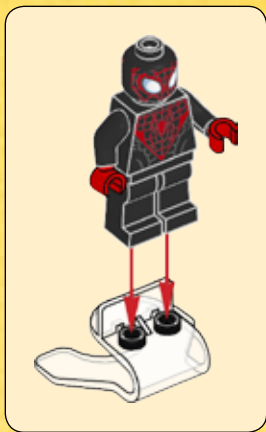



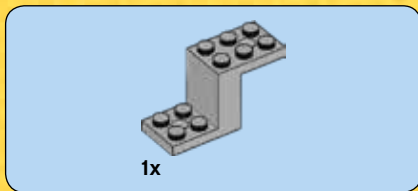

1

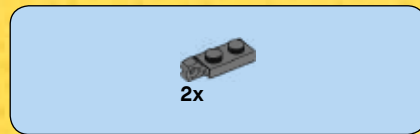
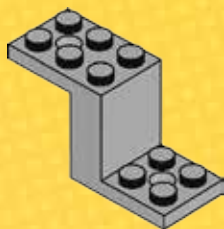

2

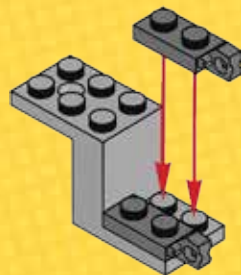



2x

3

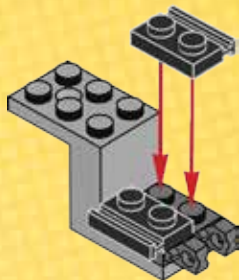

6



1x

4

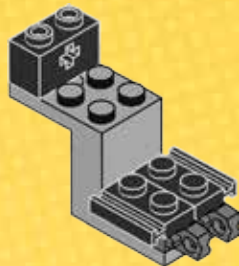



2x

5

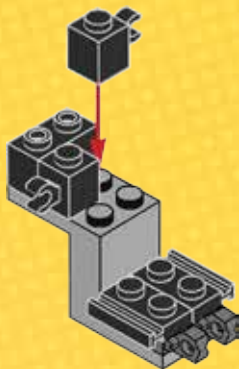

1x



1x

6

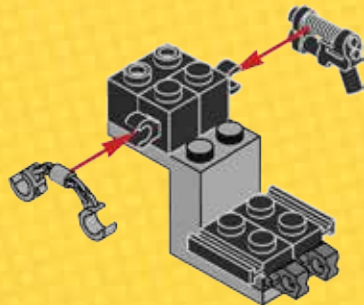



1x

7

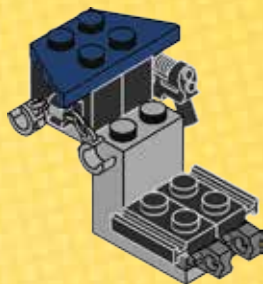

8



1x

8

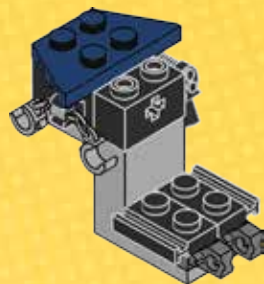



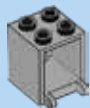

1x



1x

# 9

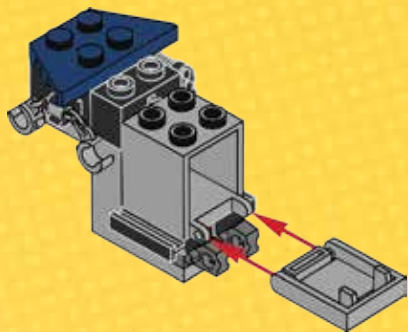

3x

# 10

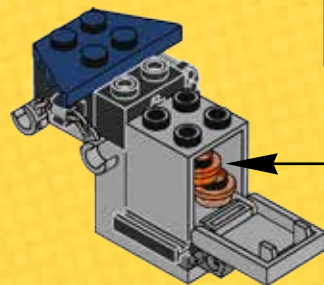

3x



2x

11

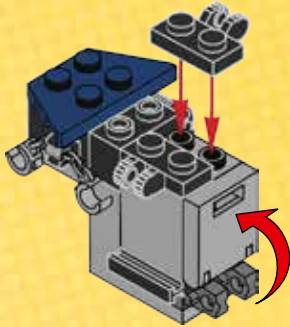

1x

12

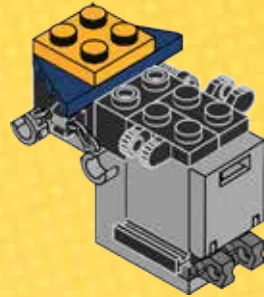



1x

13

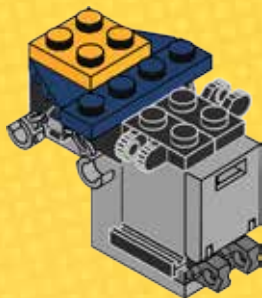

1x

14

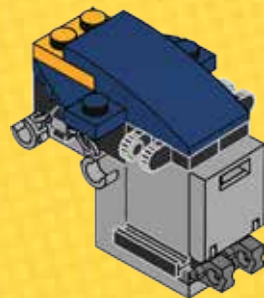

# 15

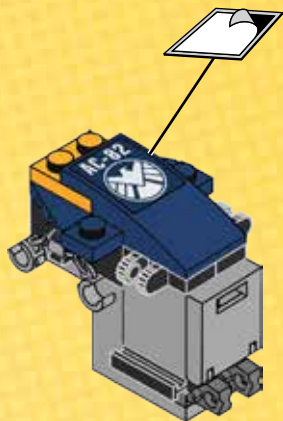

# 16

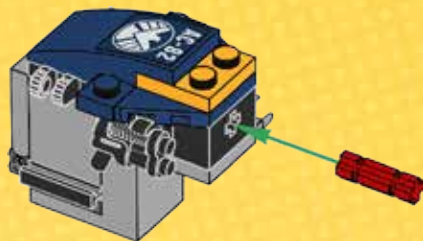
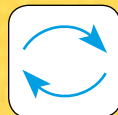





1x



2x



1x



1x



1x



1x

# 17

## 1



## 2



## 3



4

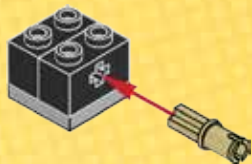

5



6



7

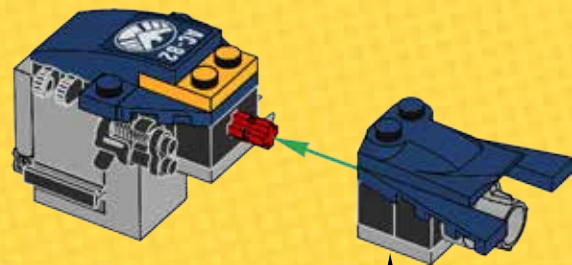



2x

18

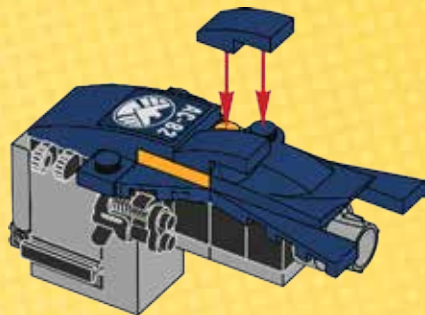

1x

19

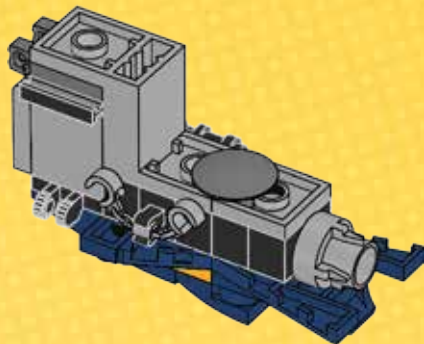





2x



2x



2x



2x



2x

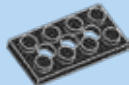

2x



2x



2x

# 20

## 1



## 2



## 3



4



5



6



7



8



2x

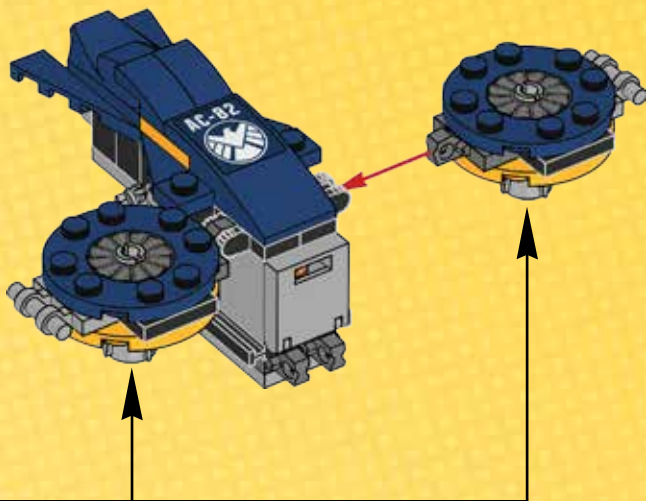





2x

# 21

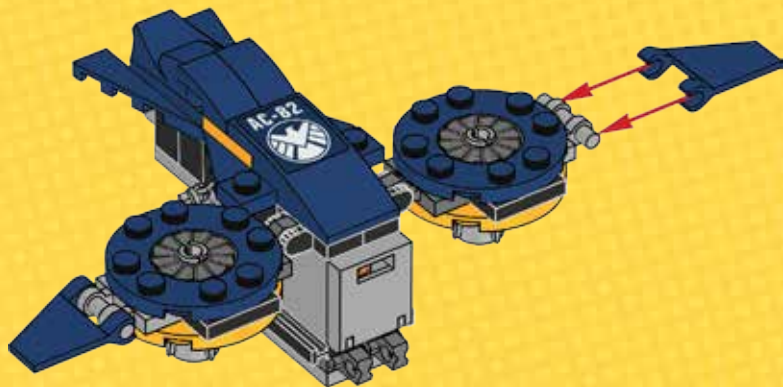



1x

1



2x

2

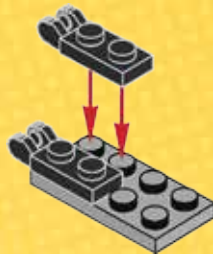



2x

3



1x

4





2x

5



2x

6

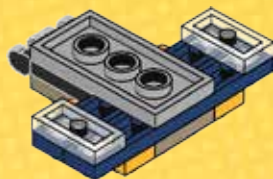
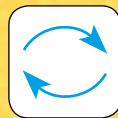



7

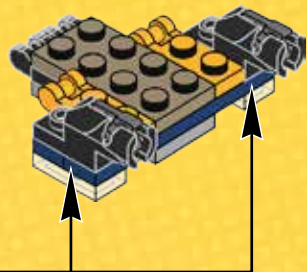
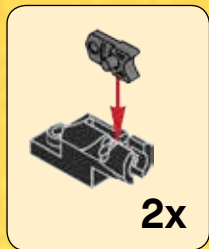

8

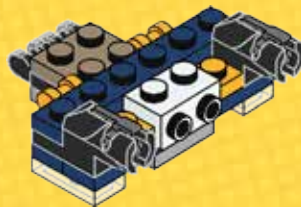



2x

9

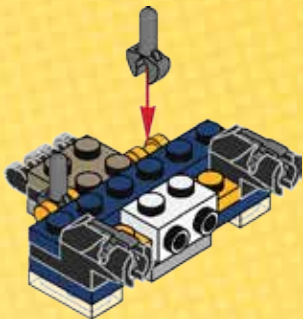

2x

10

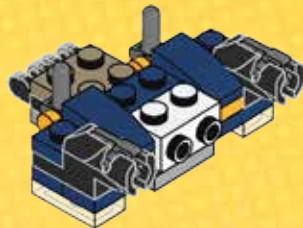





2x

11

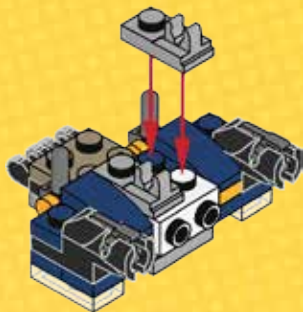

2x

12

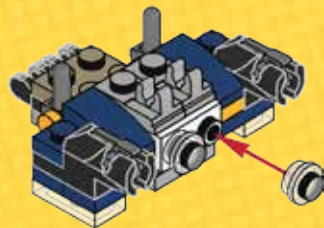

22

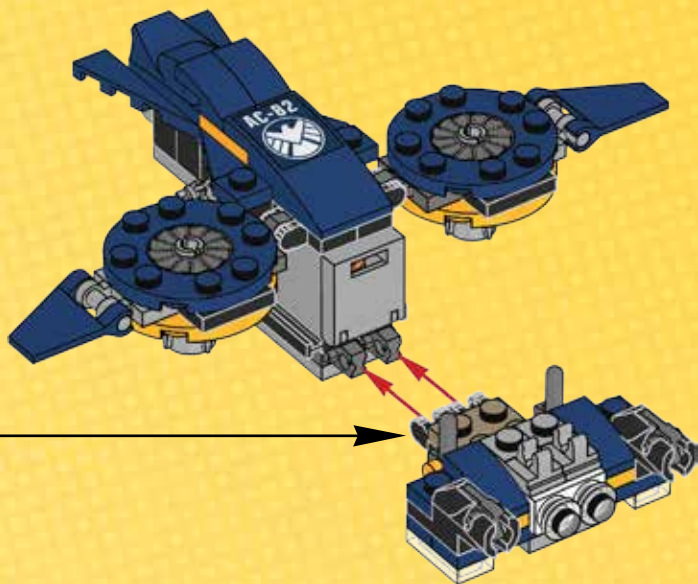

23

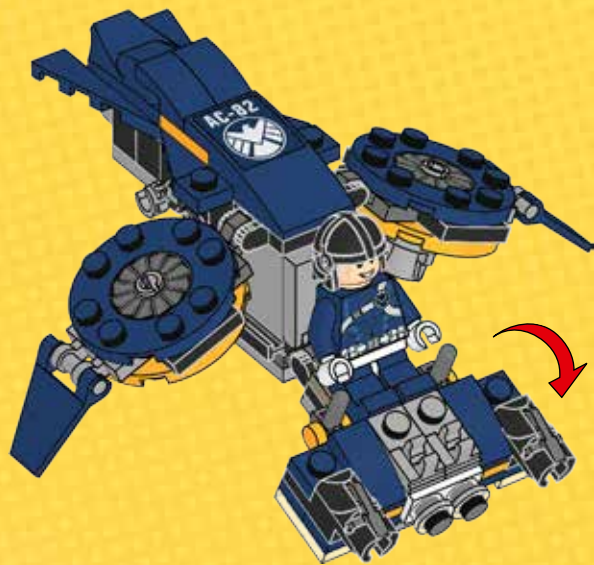



24

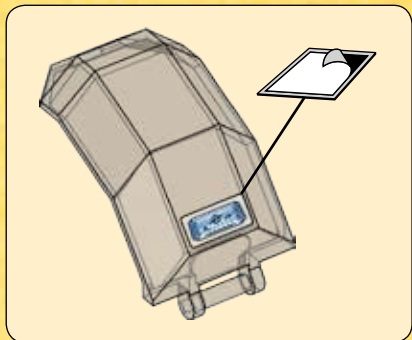
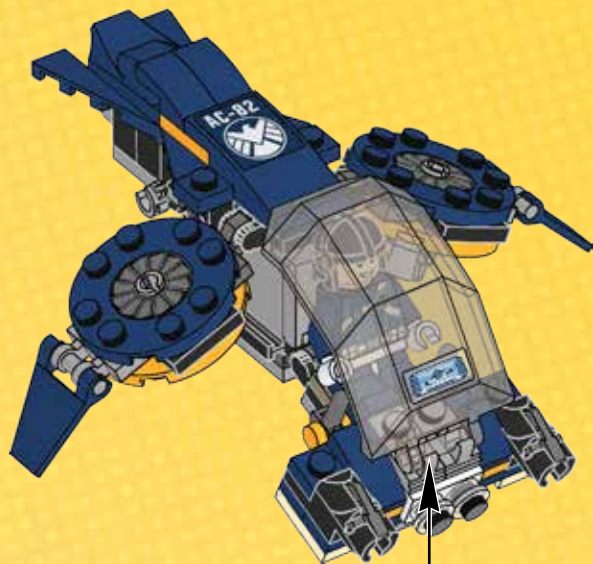



2x

25

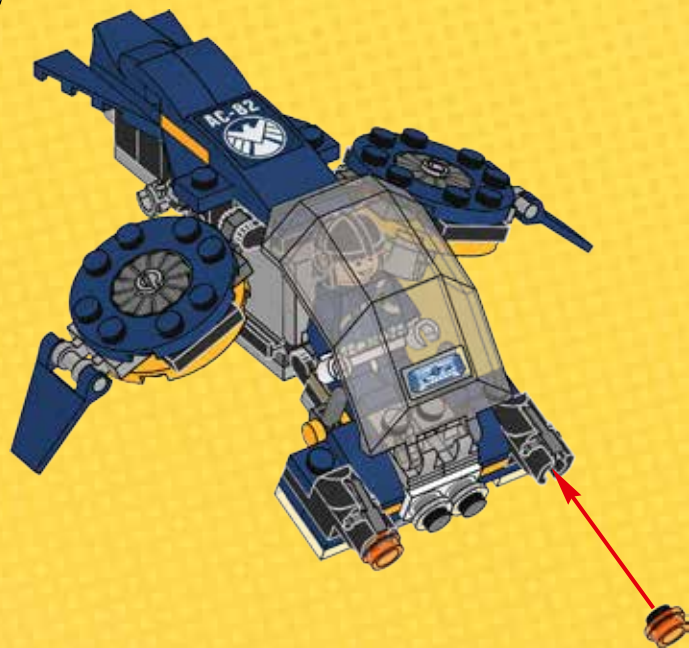









**Customer Service**

**Kundenservice**

**Service Consommateurs**

**Servicio Al Consumidor**

**LEGO.com/service or dial**



**: 00800 5346 5555**

**: 1-800-422-5346**

**LEGO**

**MARVEL**  
**SUPER**  
**HEROES**

76037



76036



76039



video games

# COMING 2015

[LEGO.com/videogames](http://LEGO.com/videogames)

# MARVEL



7  
www.pegi.info

PS3 PS4 PSVITA XBOX ONE XBOX 360 PC WiiU NINTENDO 3DS Nintendo eShop

©2015 The LEGO Group. © MARVEL.™ & © WBEI. (s15) Wii U, Nintendo DS and Nintendo 3DS are trademarks of Nintendo. © 2015 Nintendo. "PlayStation" and the "PS" Family logo are registered trademarks and the PlayStation Network Logo is a trademark of Sony Computer Entertainment Inc. KINECT, Xbox, Xbox 360, Xbox LIVE, and the Xbox logos are trademarks of the Microsoft group of companies and are used under license from Microsoft. All other trademarks and copyrights are the property of their respective owners. All rights reserved.

