



Mixels™



41539



 LEGO.com

6126510

1



2



3

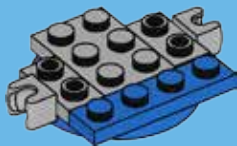

4

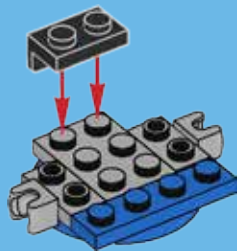

5

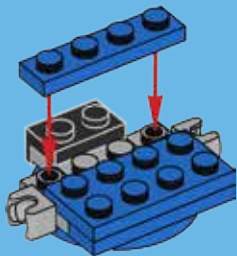

6

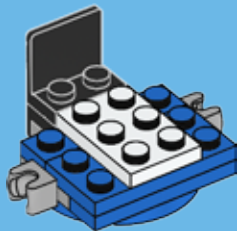

7



8

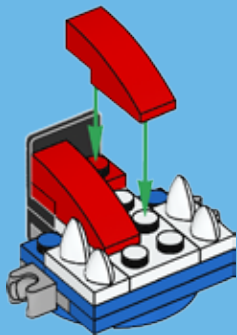

9

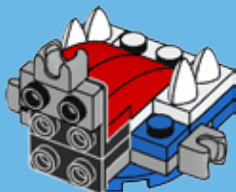

10

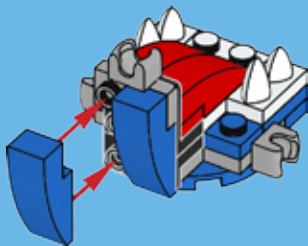



11

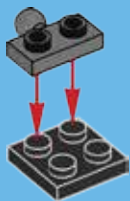

12



13

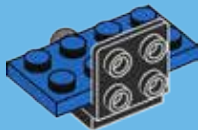

14

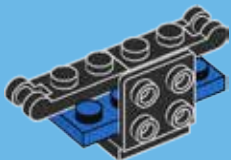

15

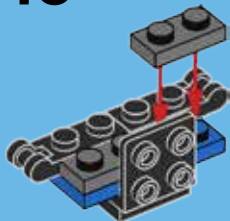

16



17

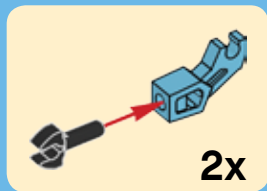
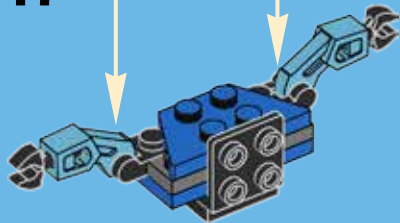



18



19



20



21



22

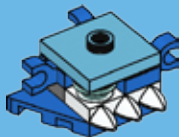

23

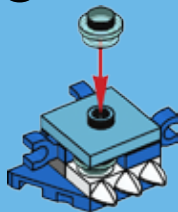

24

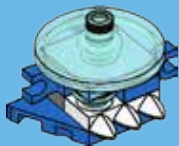

25



26



27

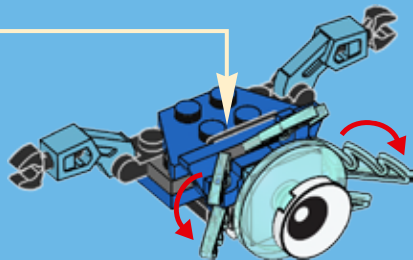



28

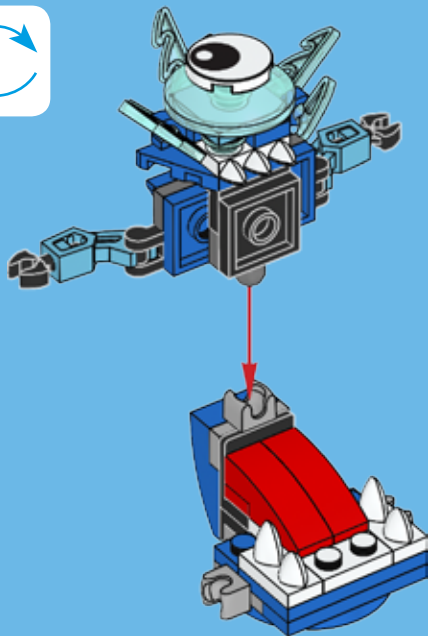

29

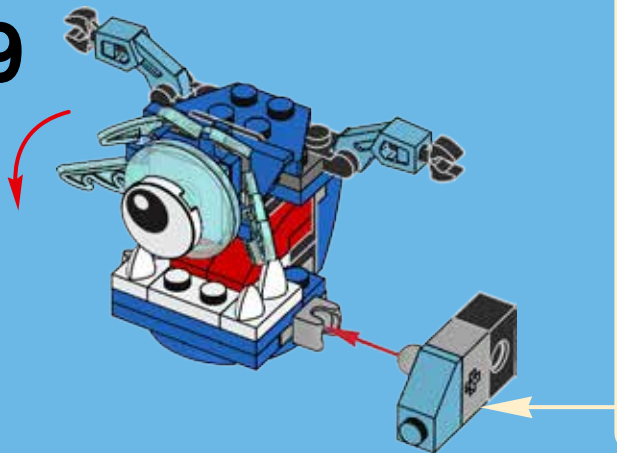

1



2

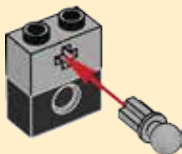

3



1



2

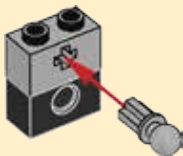

3



30

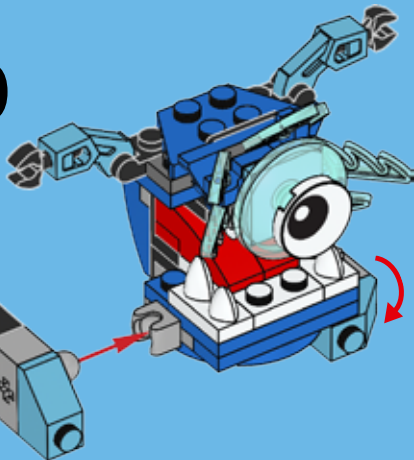

31

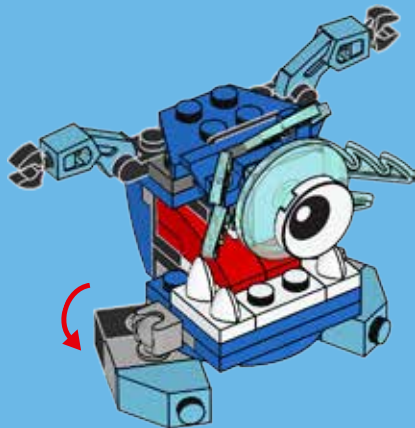



1

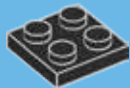

2



3

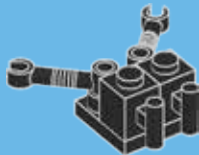

4

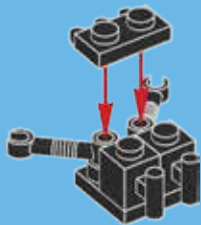

5

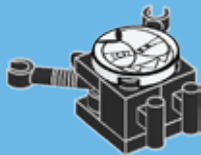

6





2x
6104486



1x
302101



2x
4163917



2x
302226



3x
4520946



2x
4251162



2x
4619655



1x
6060732



1x
6060829



1x
6016172



2x
371023



3x
4211063



1x
6060734



3x
6021974



2x
6000650



2x
302023



1x
6039479



1x
6003008



2x
6046384



2x
292126



2x
4515368



2x
4609454



2x
4211375



1x
6046381



2x
370026



1x
6094141



1x
4581501



2x
4233493

Customer Service

Kundenservice

Service Consommateurs

Servicio Al Consumidor

LEGO.com/service or dial



00800 5346 5555 :



1-800-422-5346 :



2x
4289538



2x
4543998



1x
4211396



2x
4141580



1x
302321



3x
6043656



**KROG
41539**



**FROSTICONS
MAX!**



**CHILBO
41540**



**SNOOF
41541**



LEGO.com/mixels





Mixels™

SERIES
5



**41536
GOX**



**41537
JINKY**



**41538
KAMZO**



**41539
KROG**



**41540
CHILBO**



**41541
SNOOF**



**41542
SPUGG**



**41543
TURG**



**41544
TUNGSTER**



LEGO.com/mixels





**YOU CAN
BUY THE
GAME!**

MIXELS RUSH

CHI11YCHO3P

IN GAME CODE!



Apple, the Apple logo, iPad, iPhone and iPod touch are trademarks of Apple Inc. Google Play is a trademark of Google Inc.