

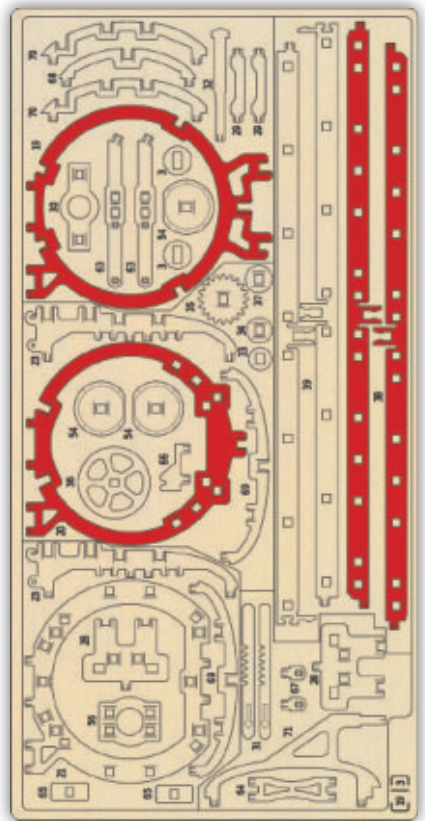

Wood Trick®

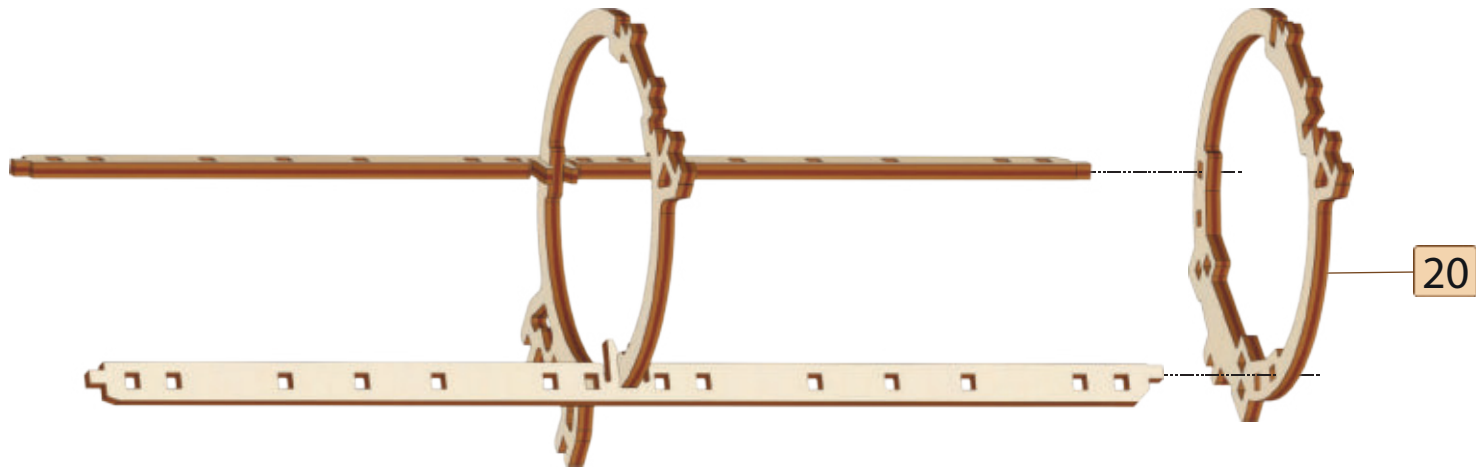

3

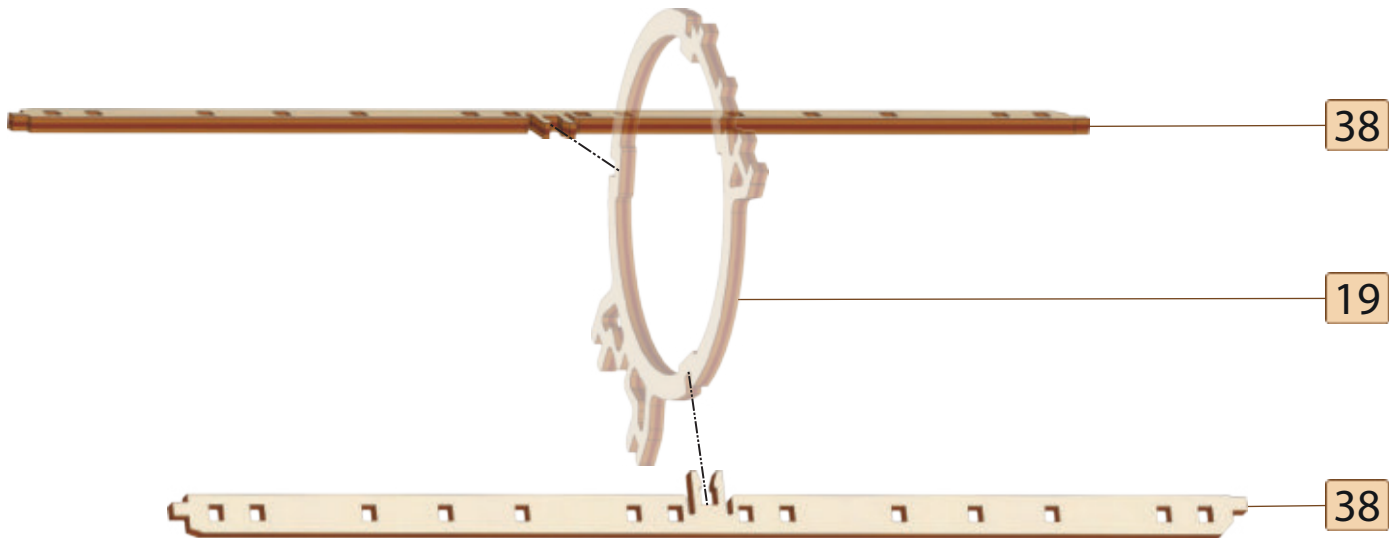

[1]

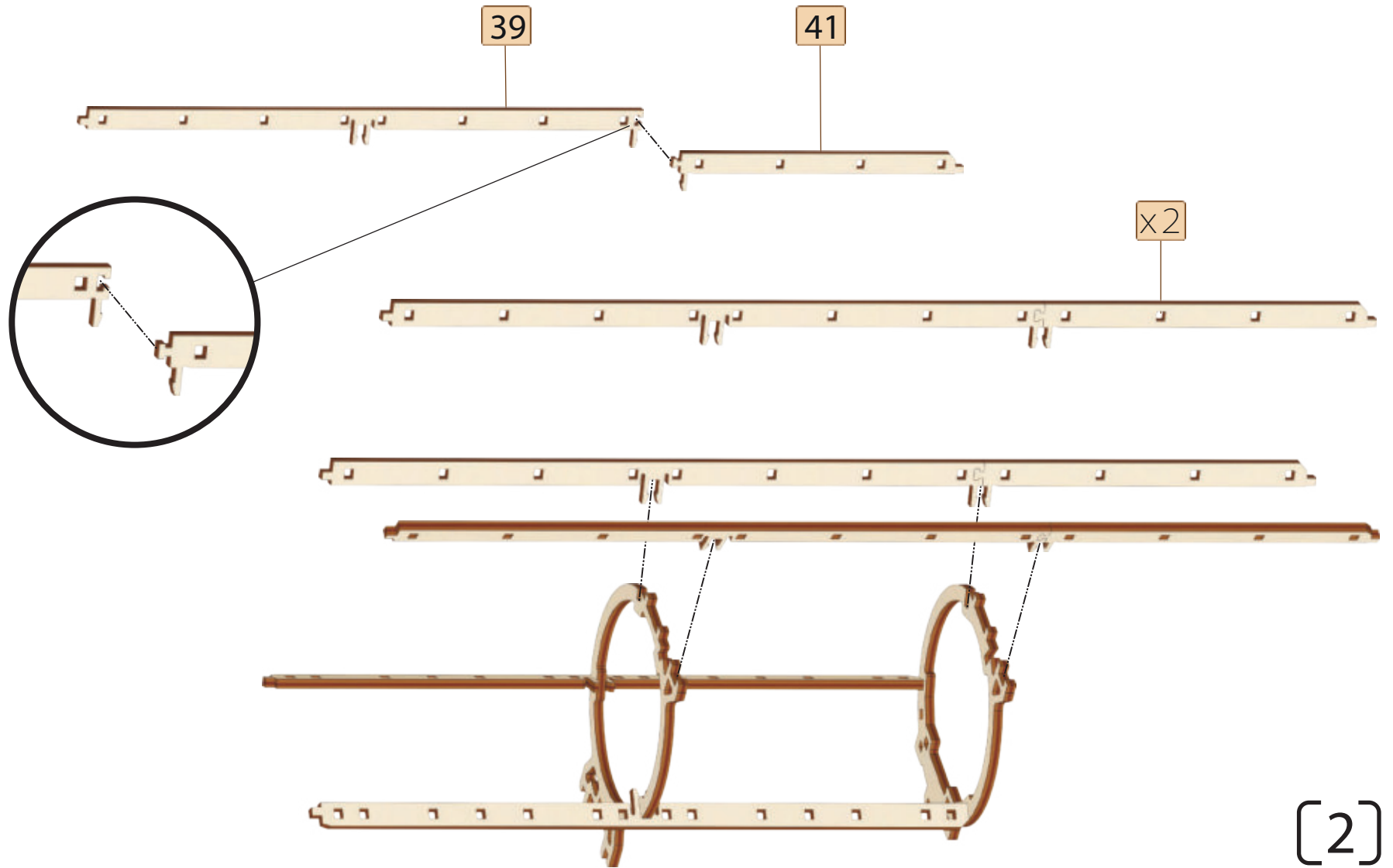
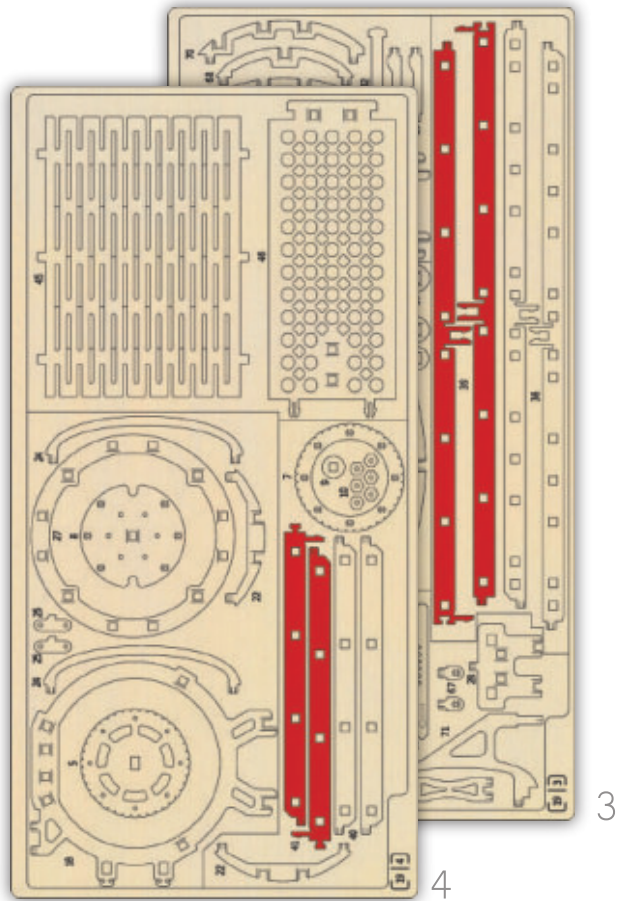

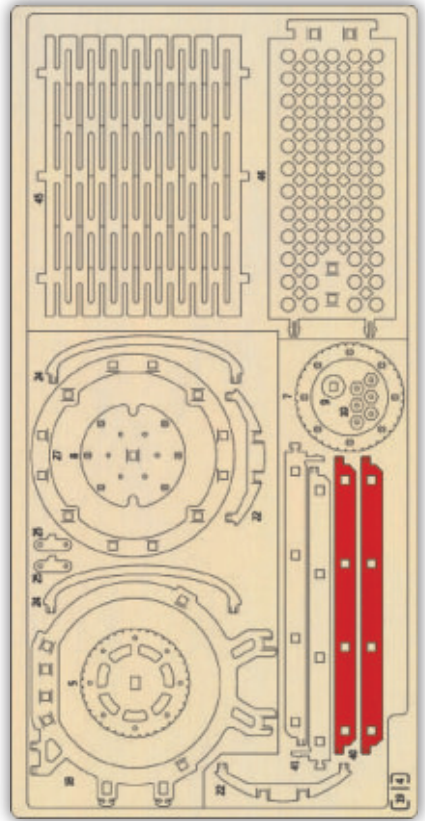

4

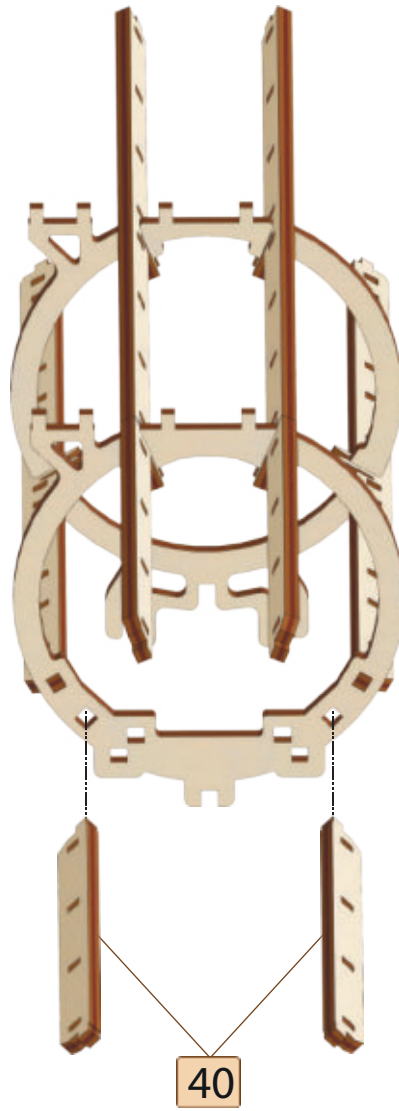

40



[3]

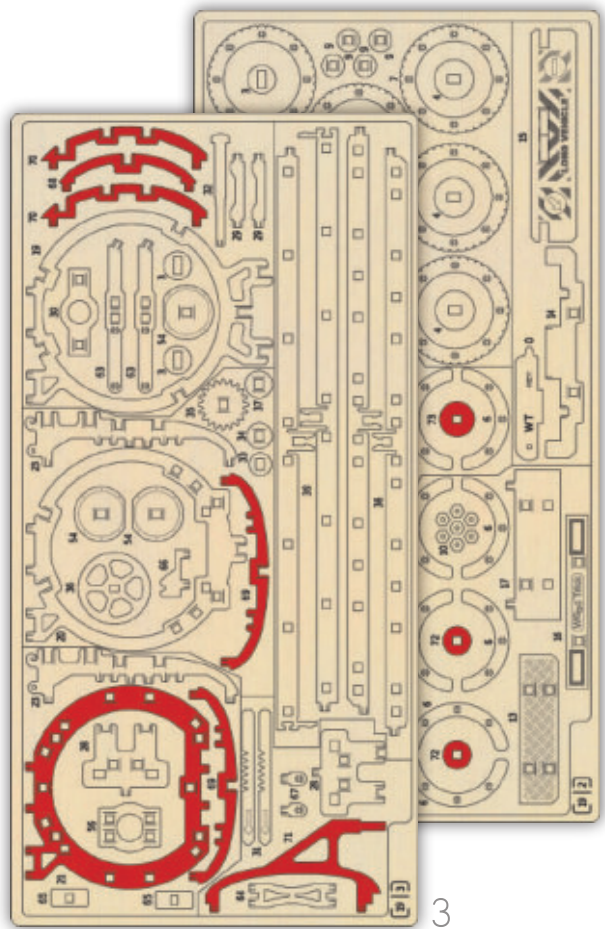

3

2

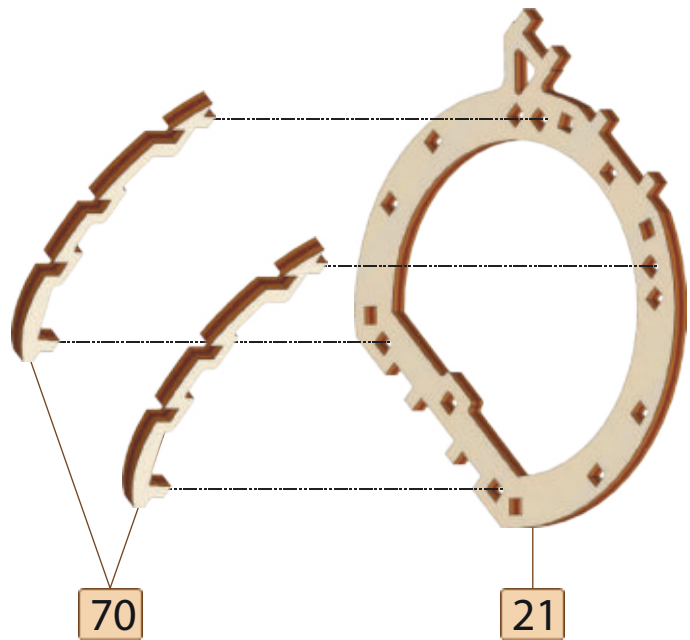

70

21

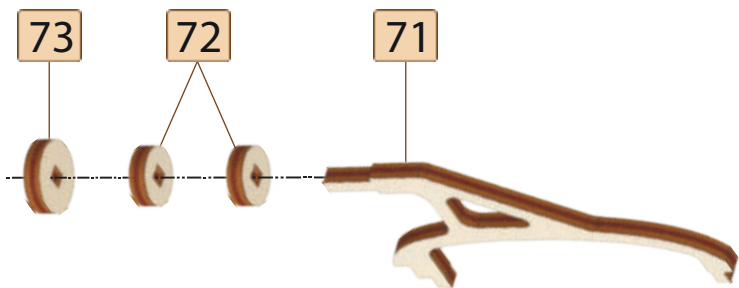

73

72

71

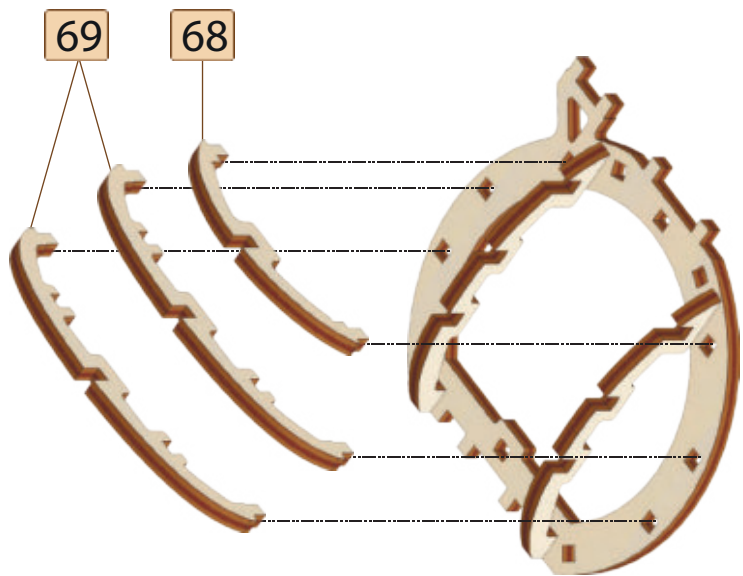

69

68



[4]

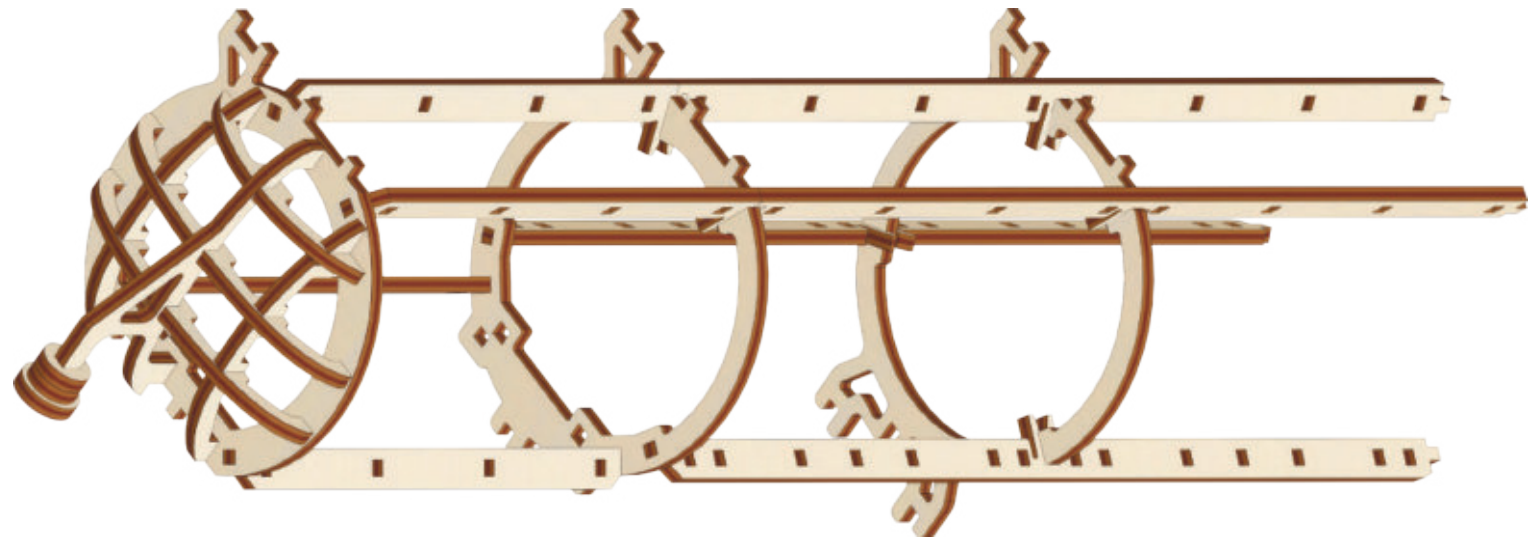
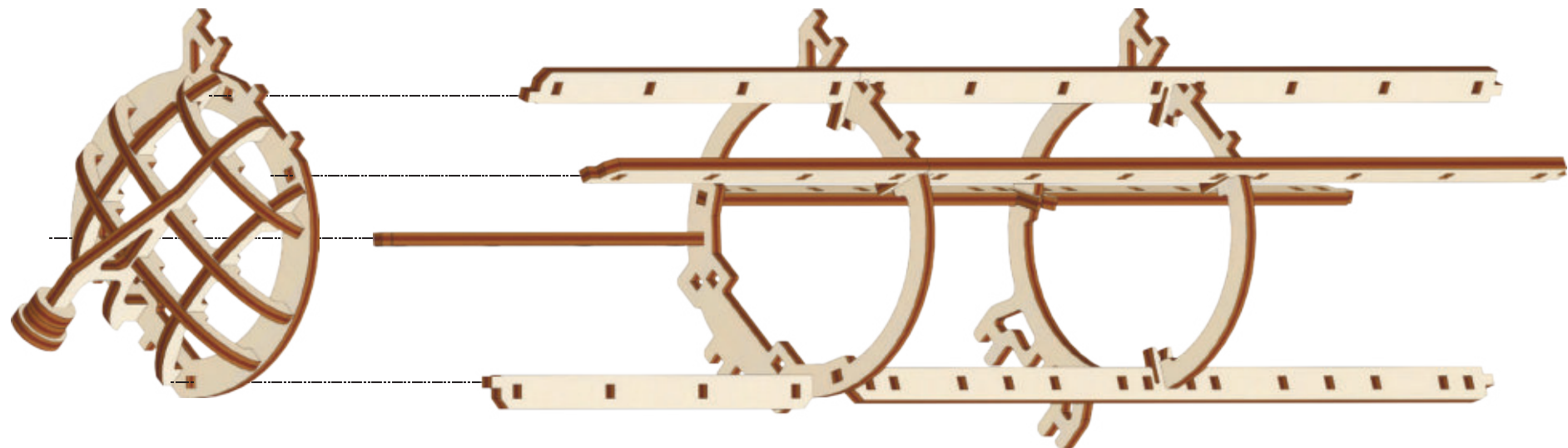

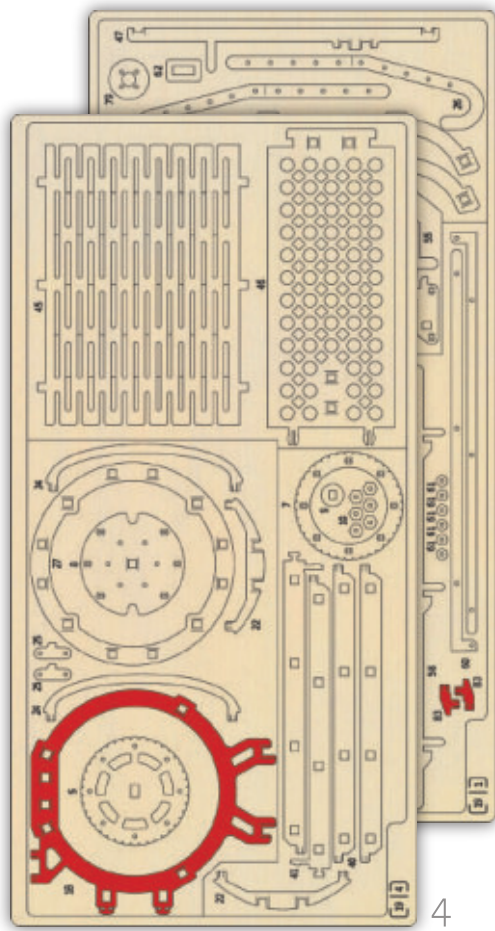

1

4

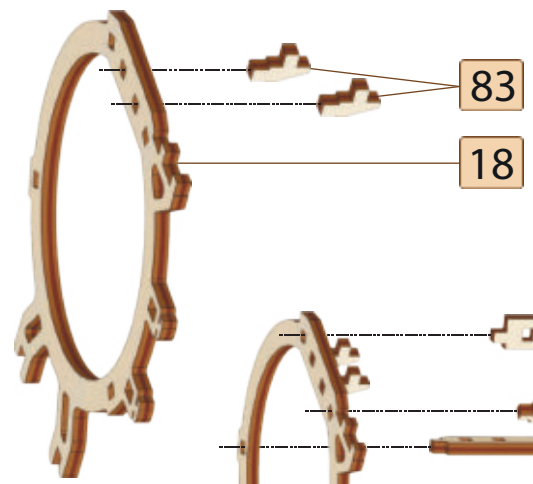

83

18

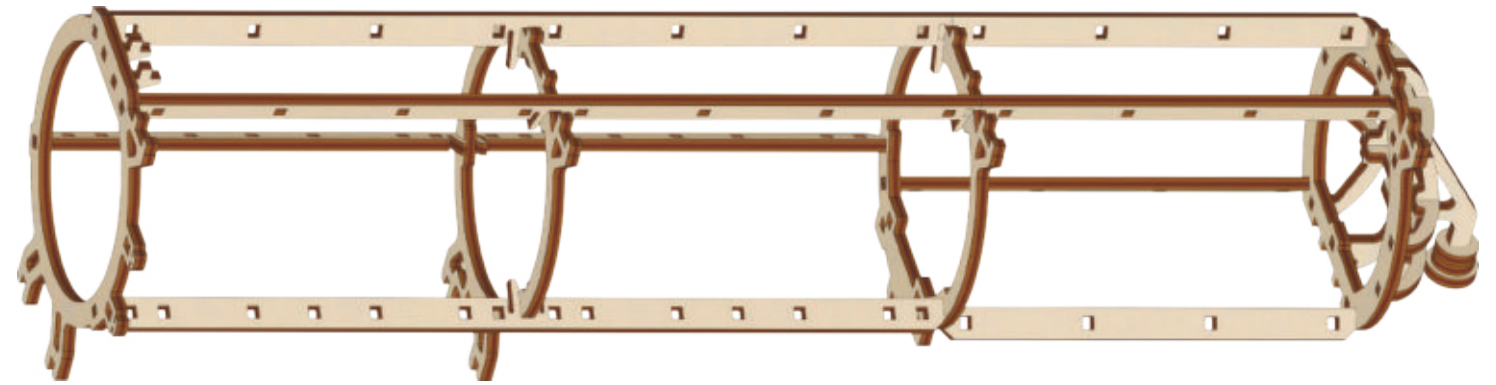
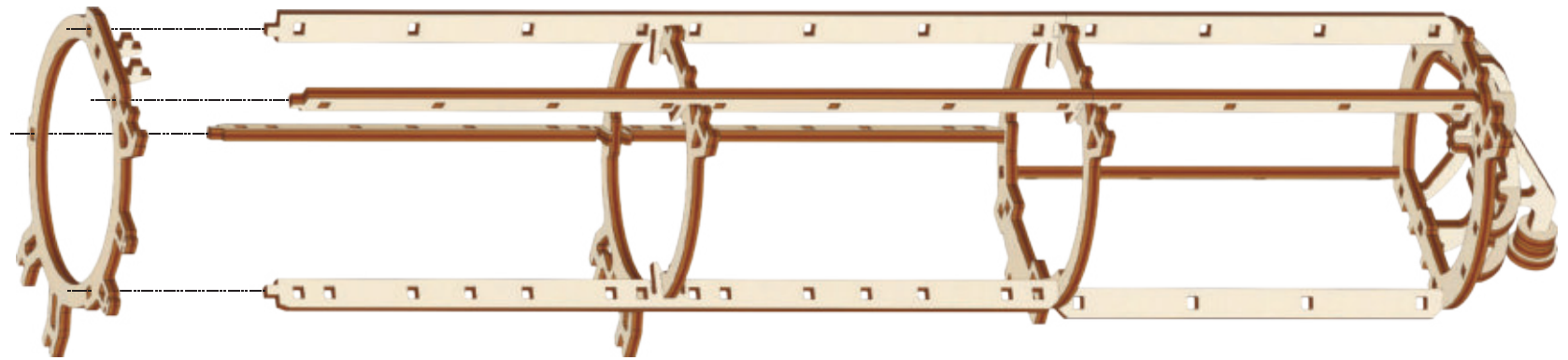

[6]

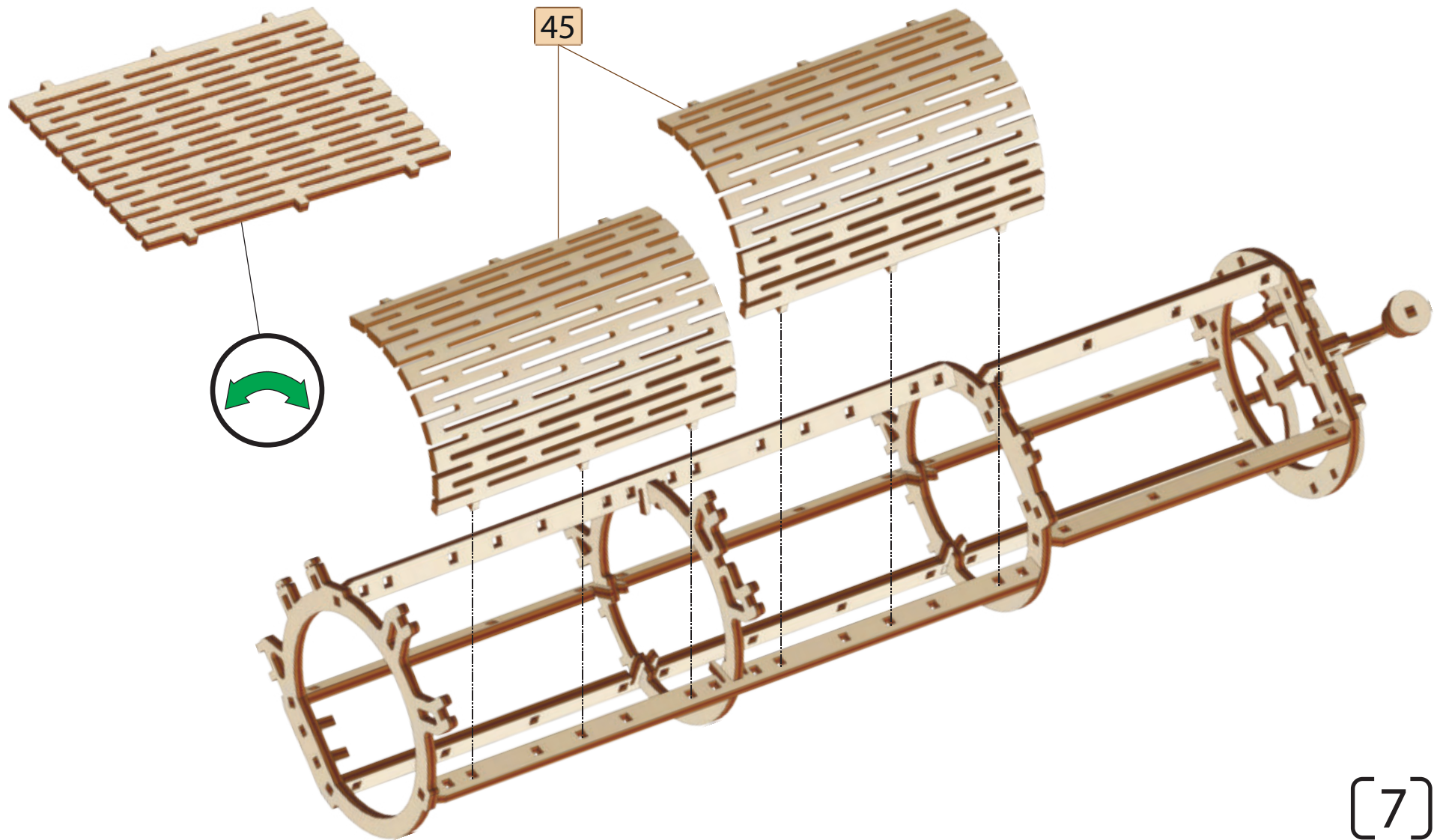
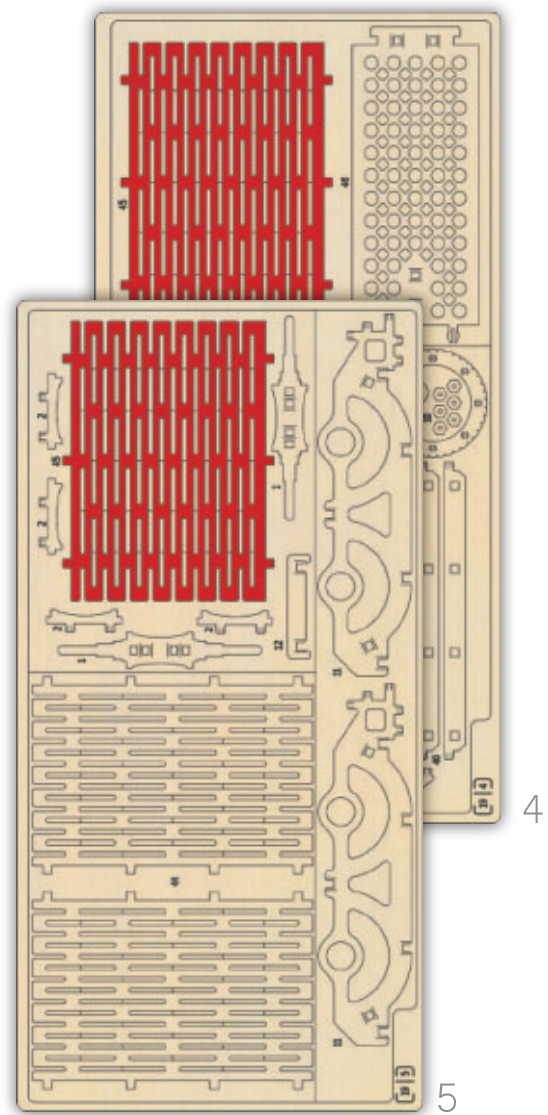

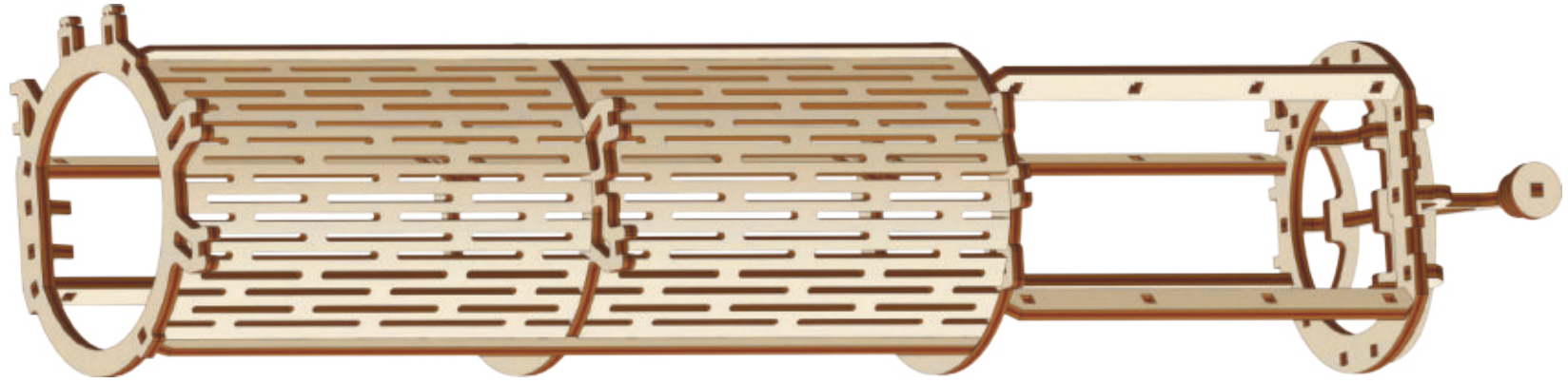
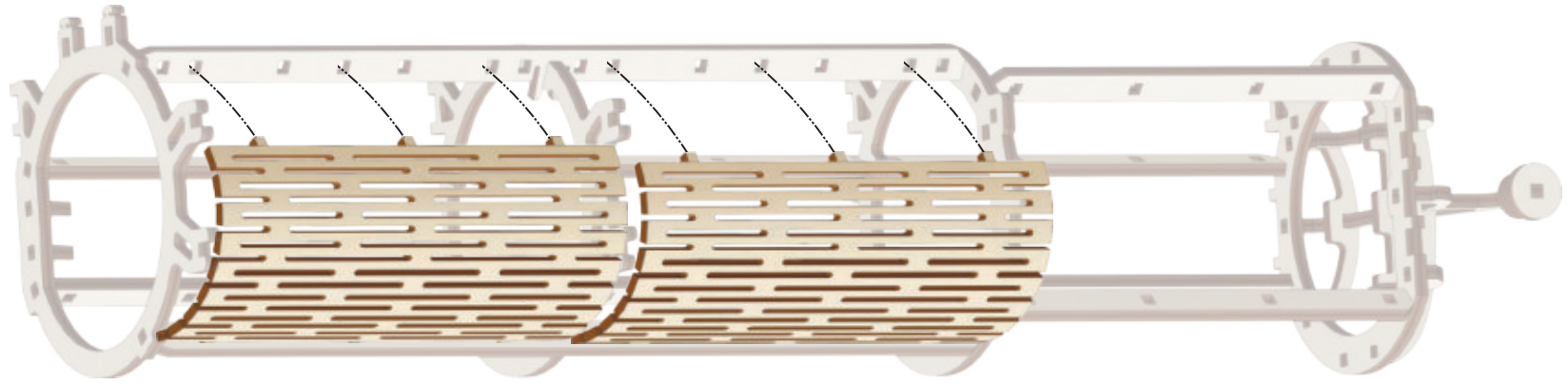

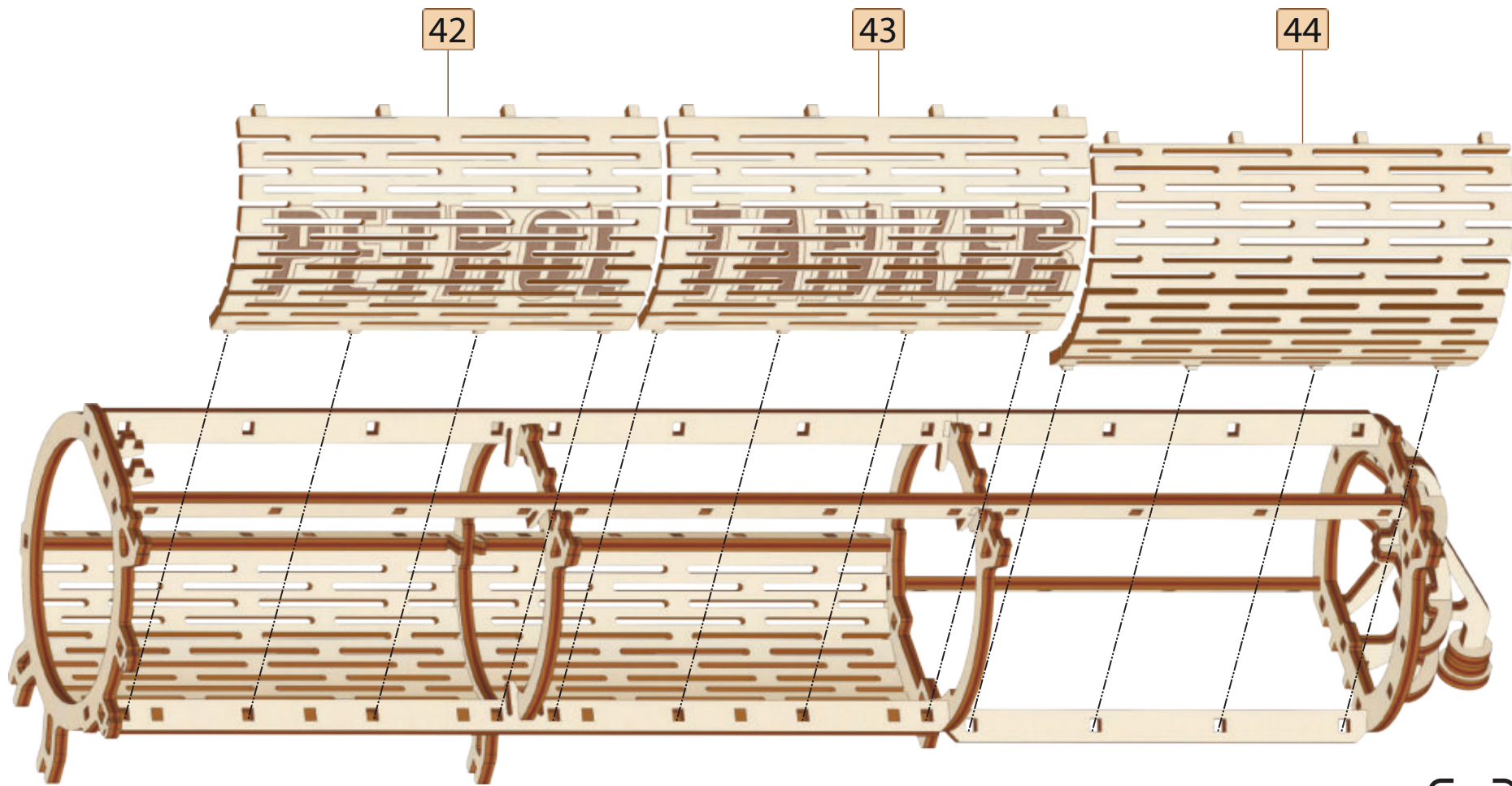
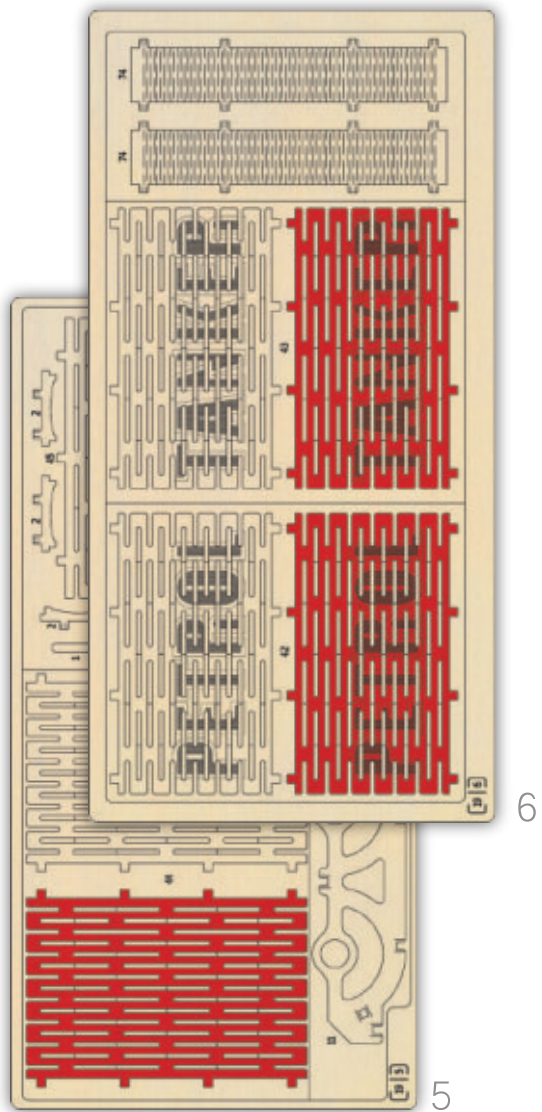

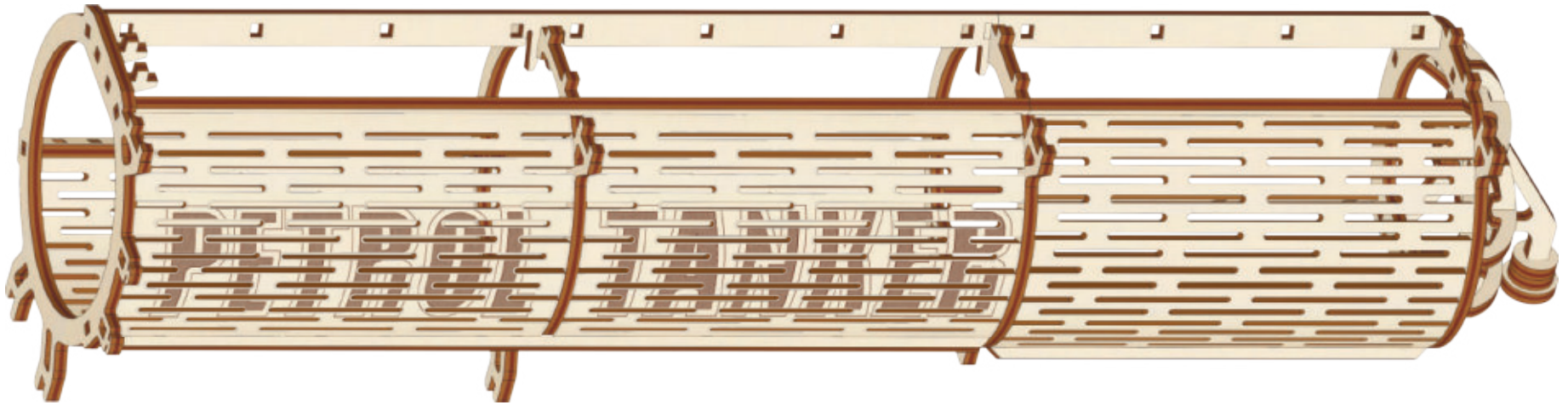
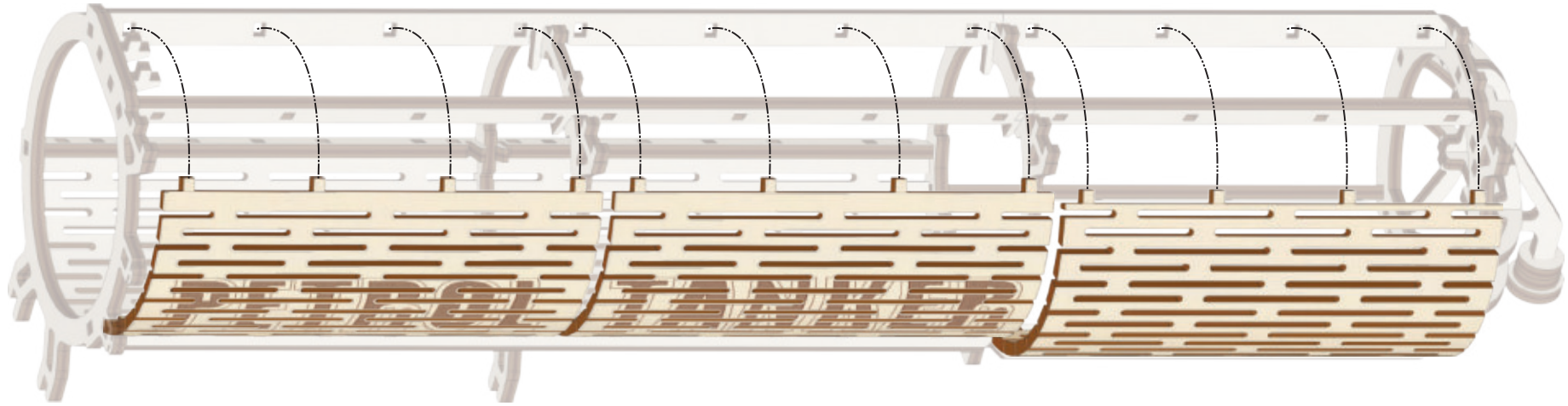

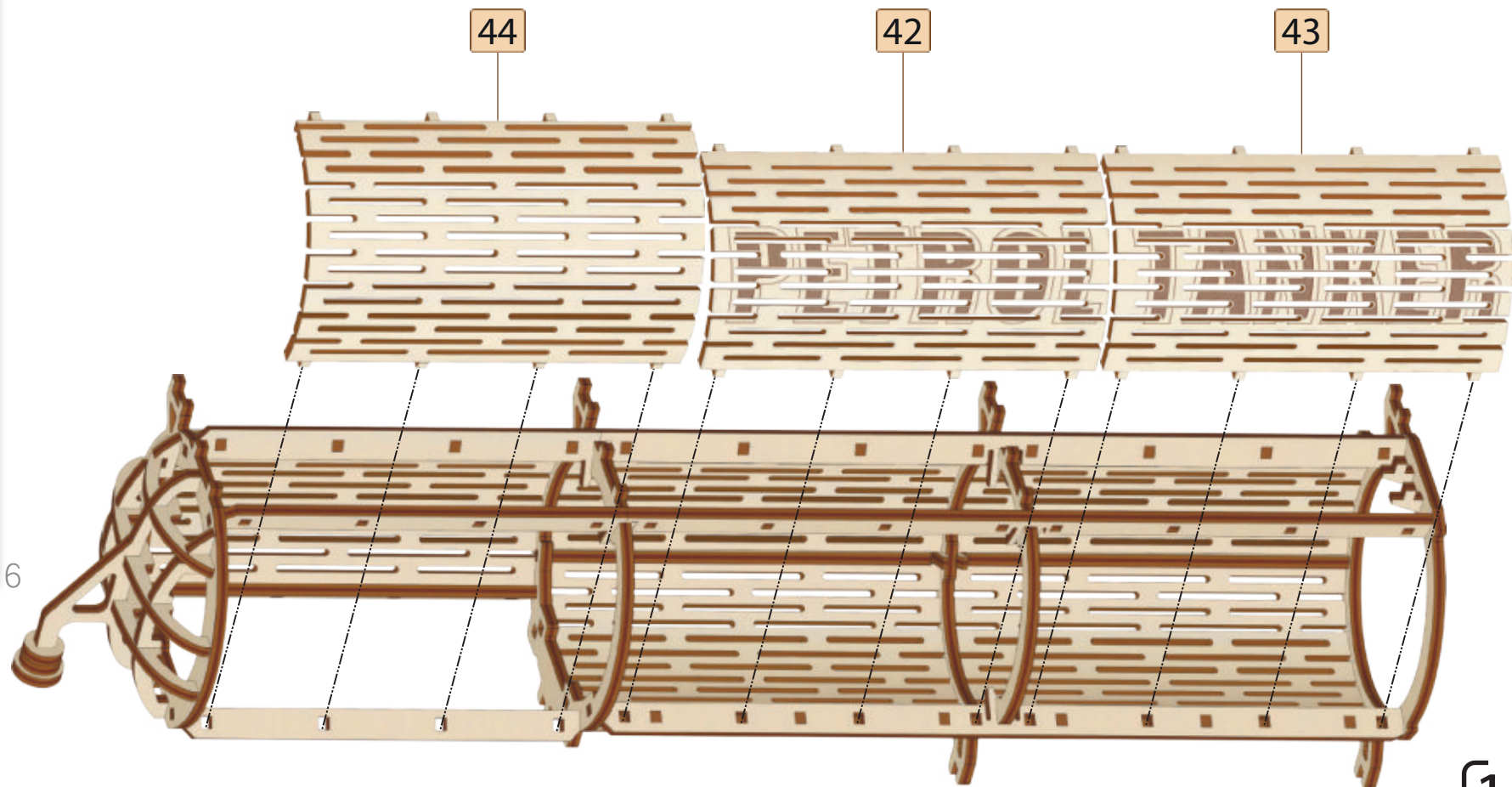
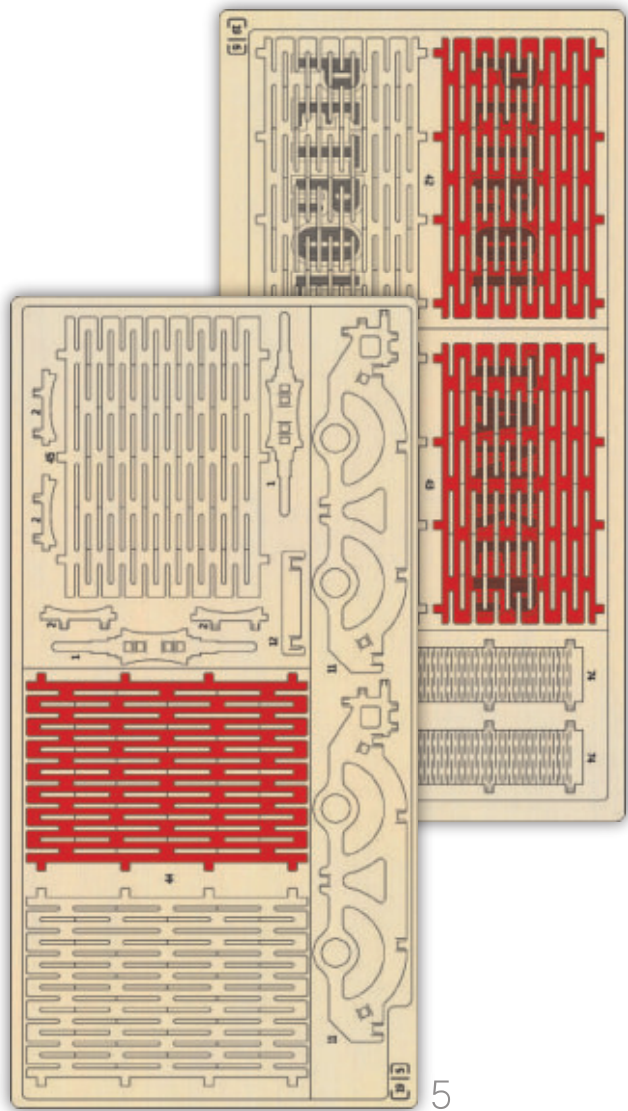

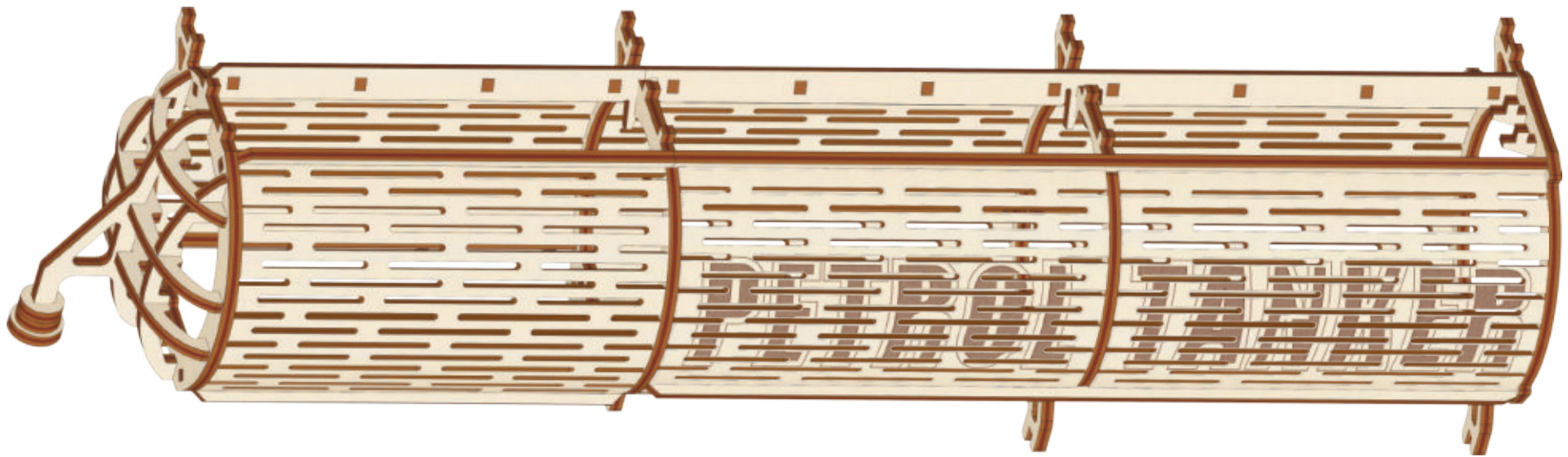
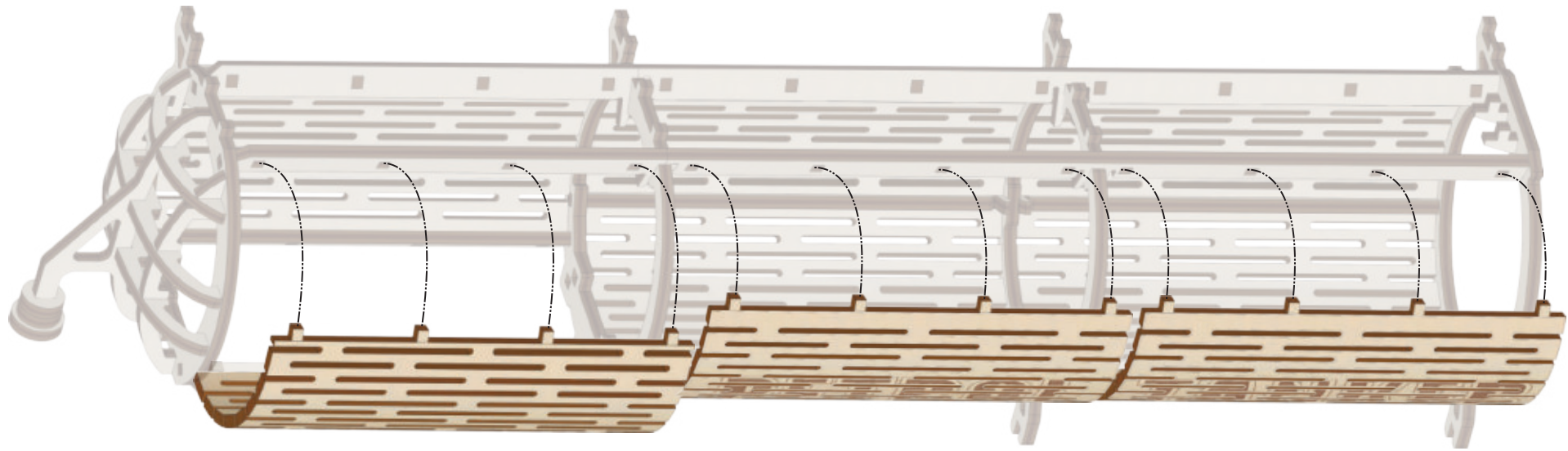

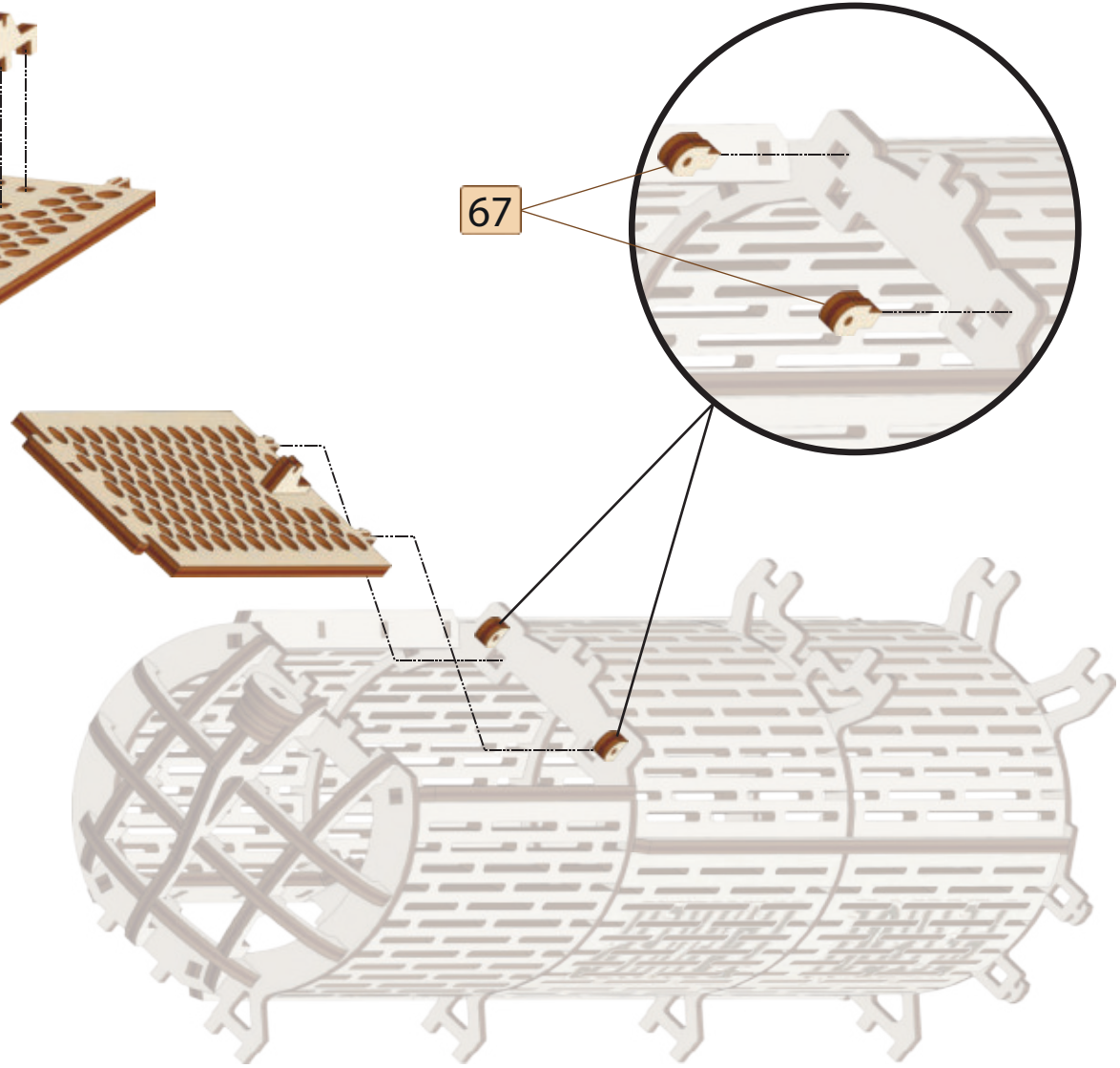
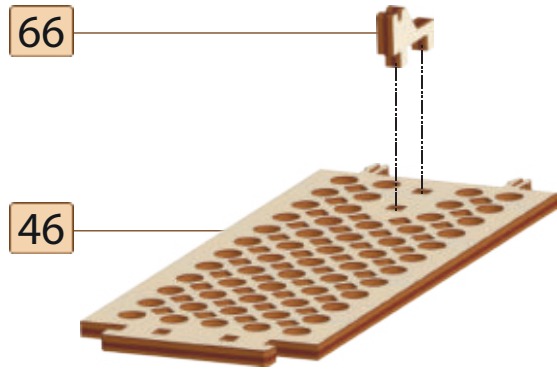
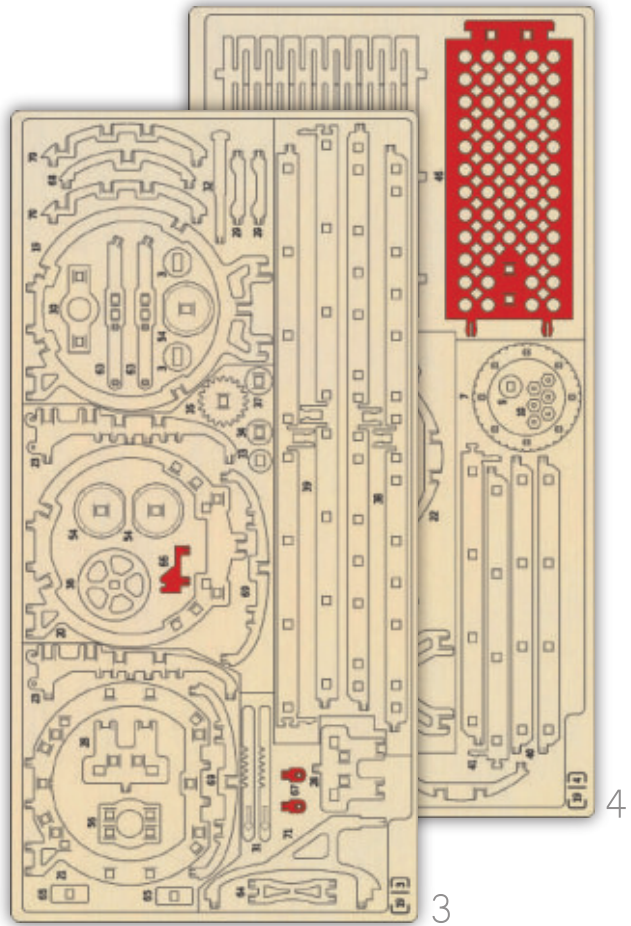

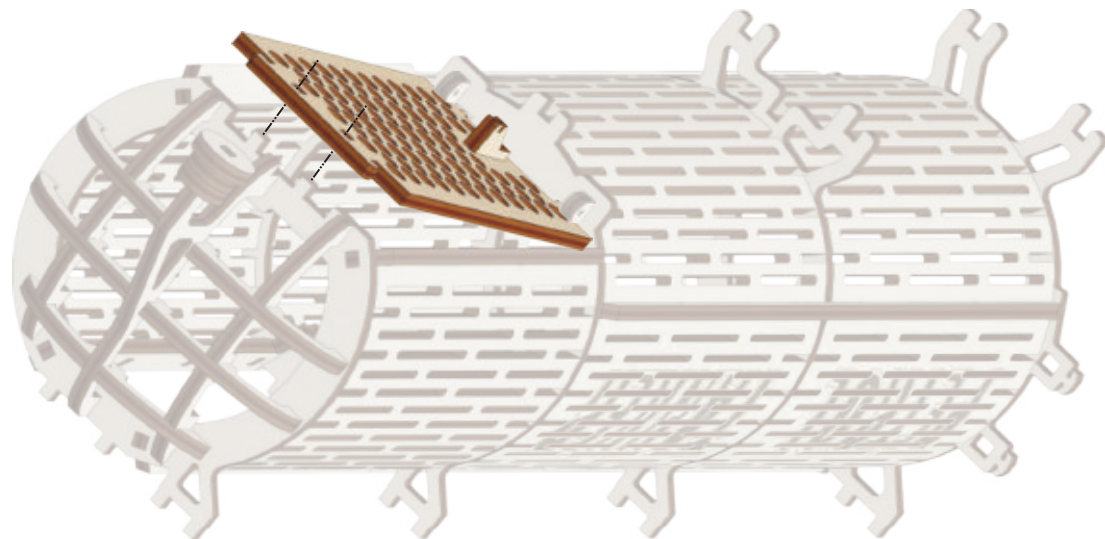

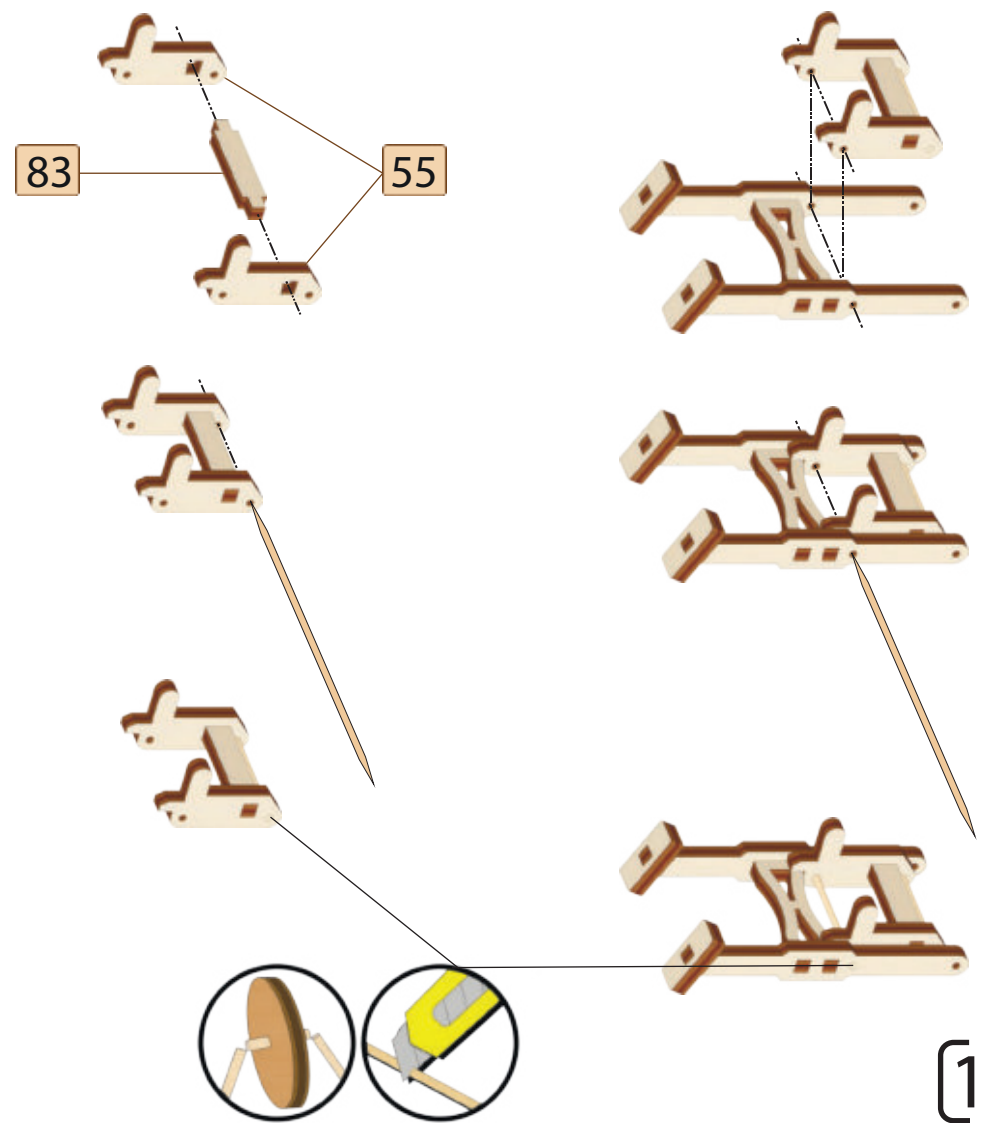
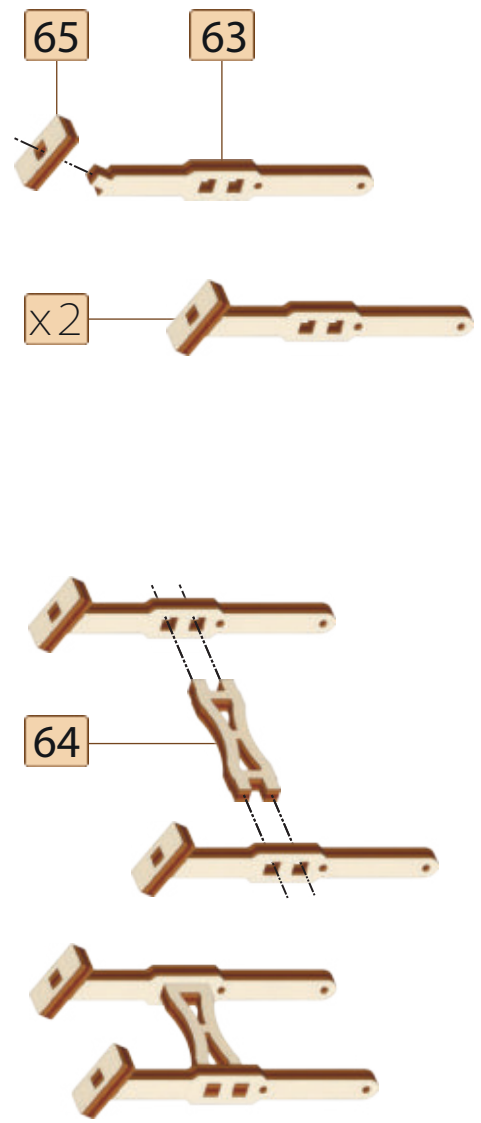
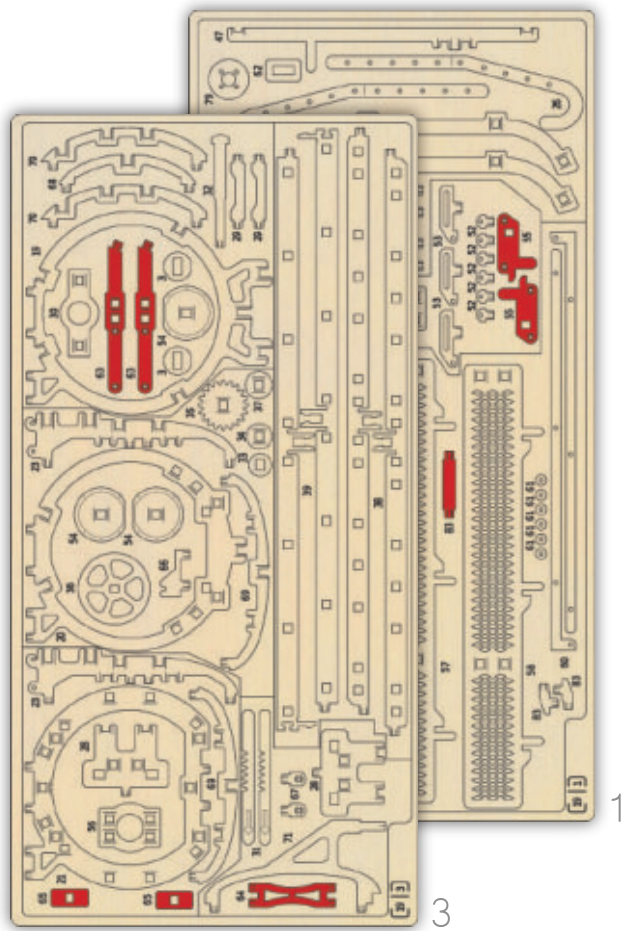

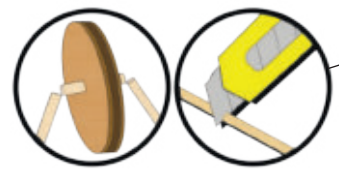
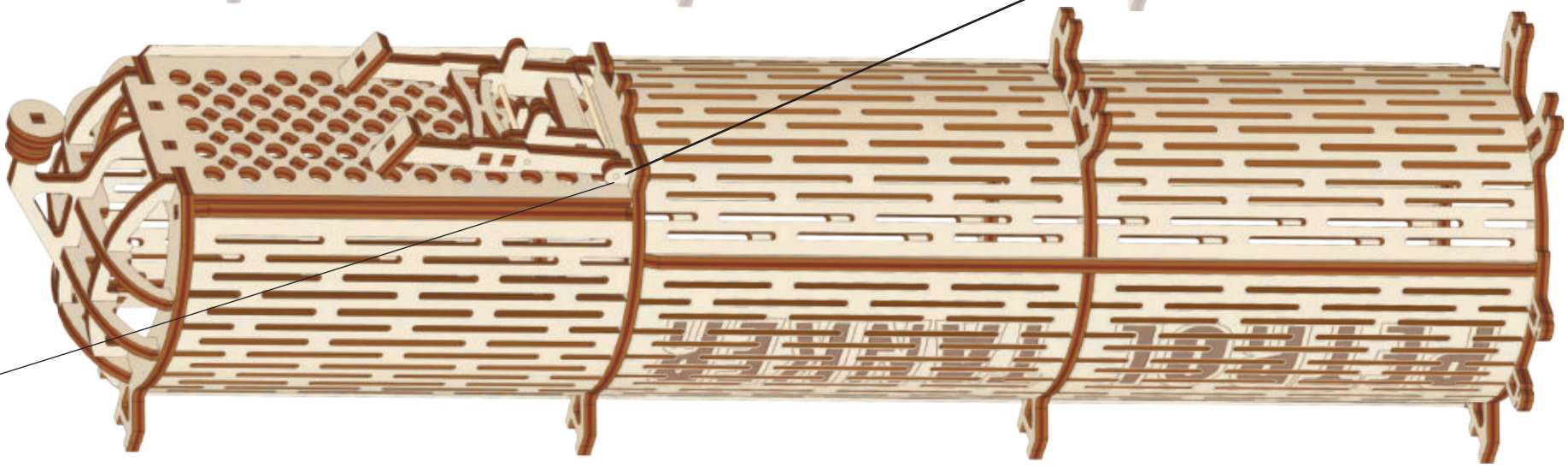
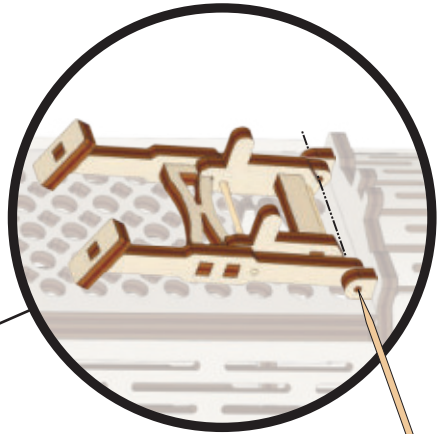
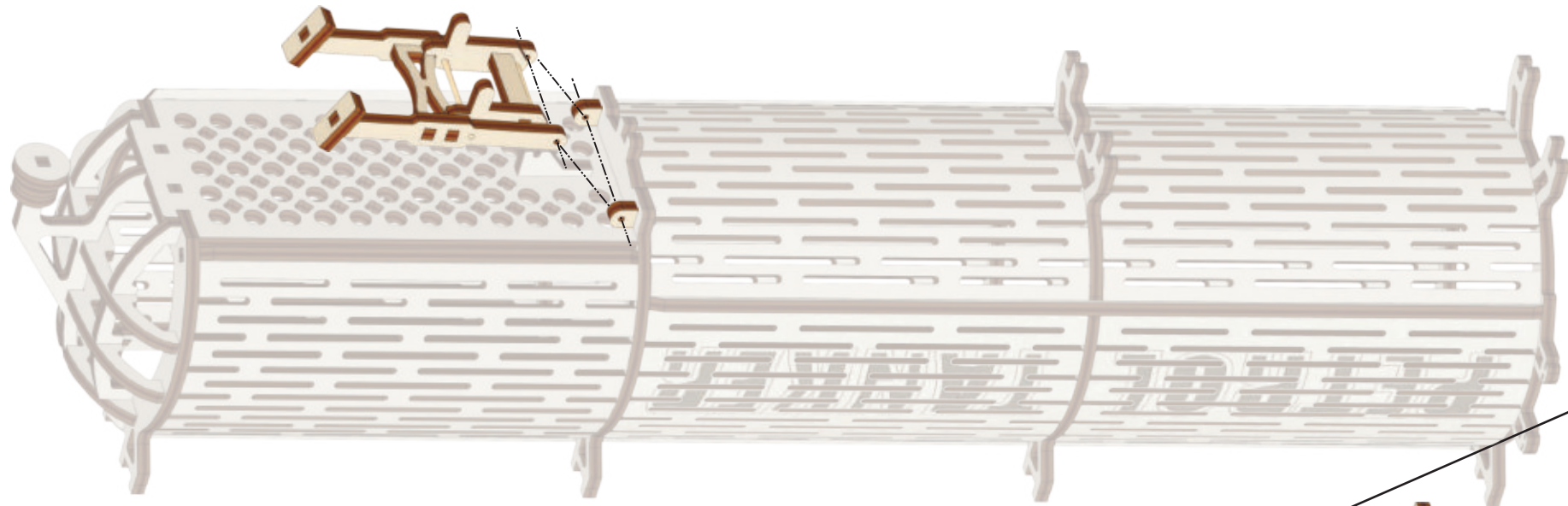

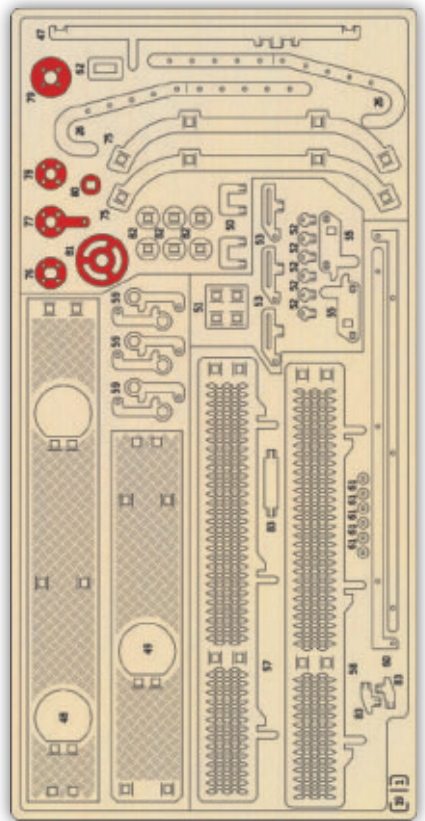

1

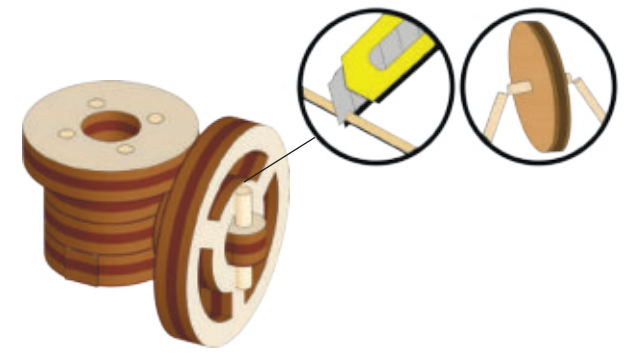
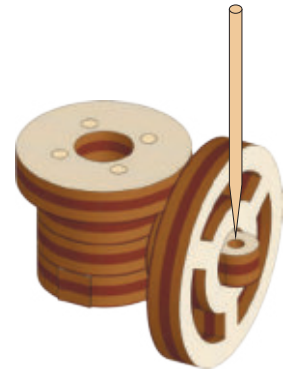
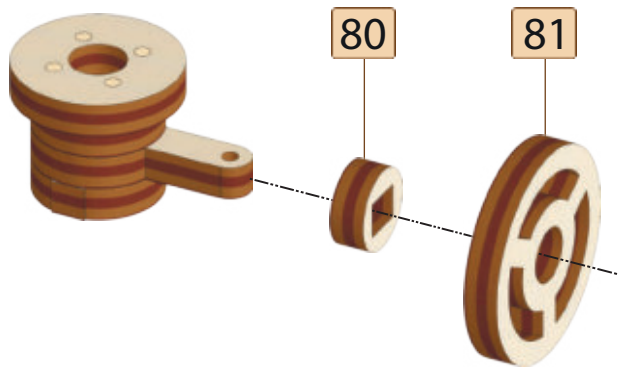
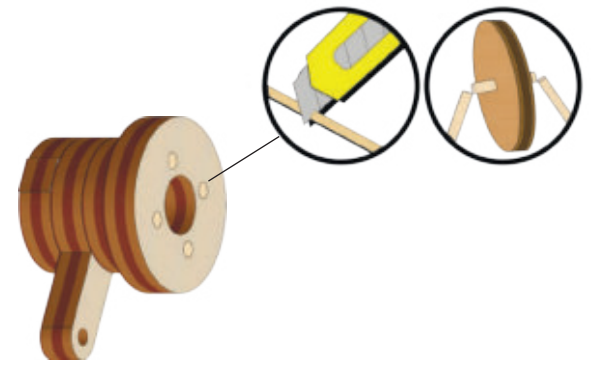
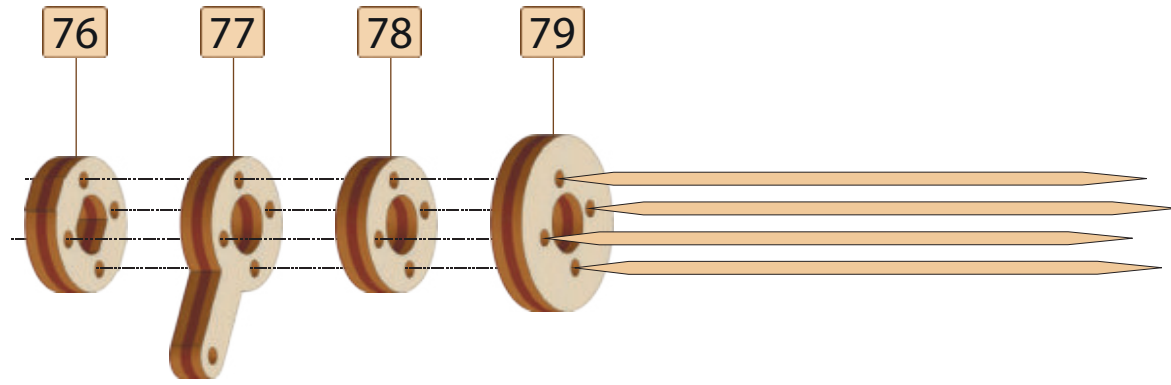

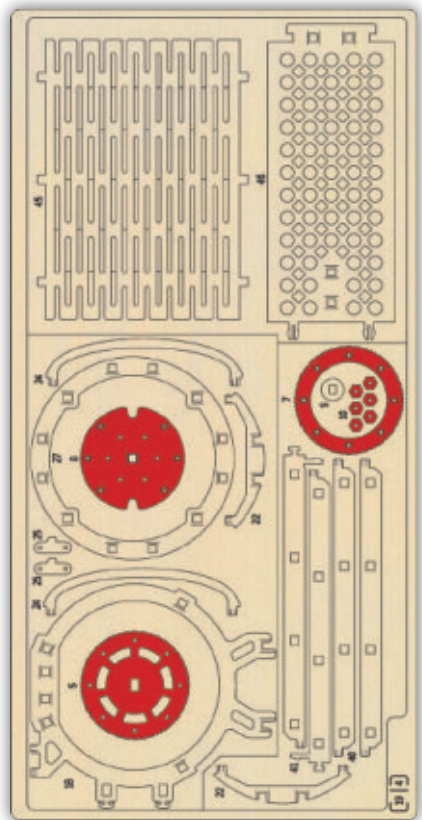

4

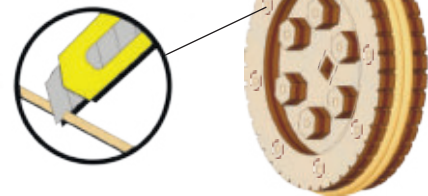
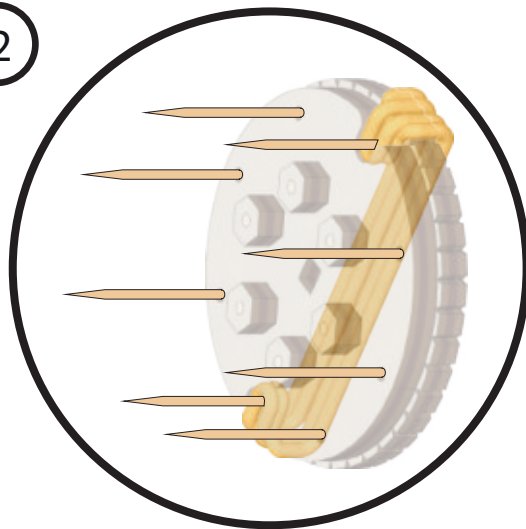
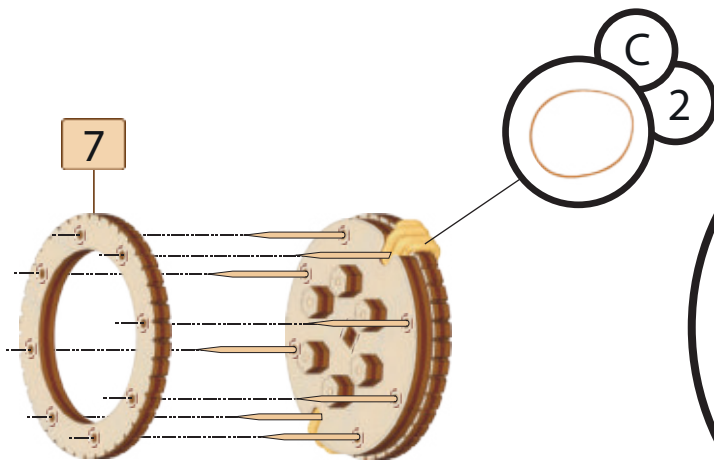
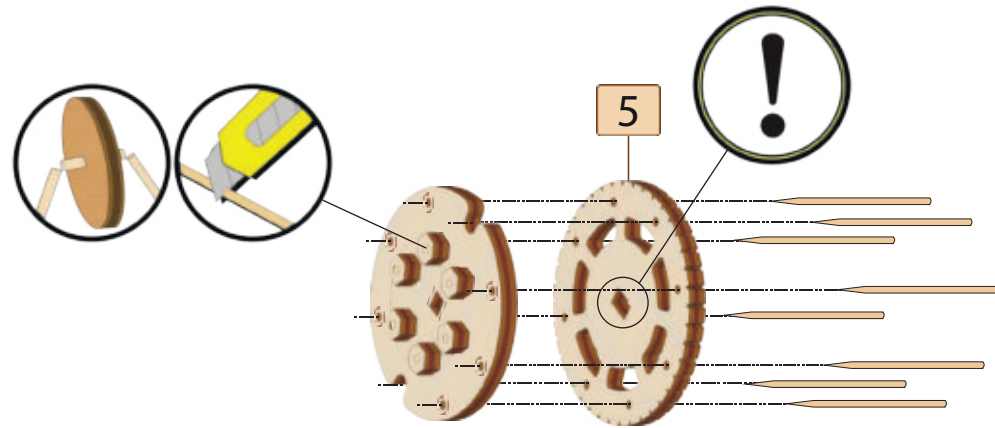
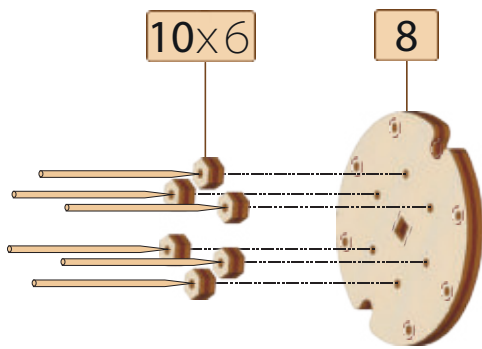

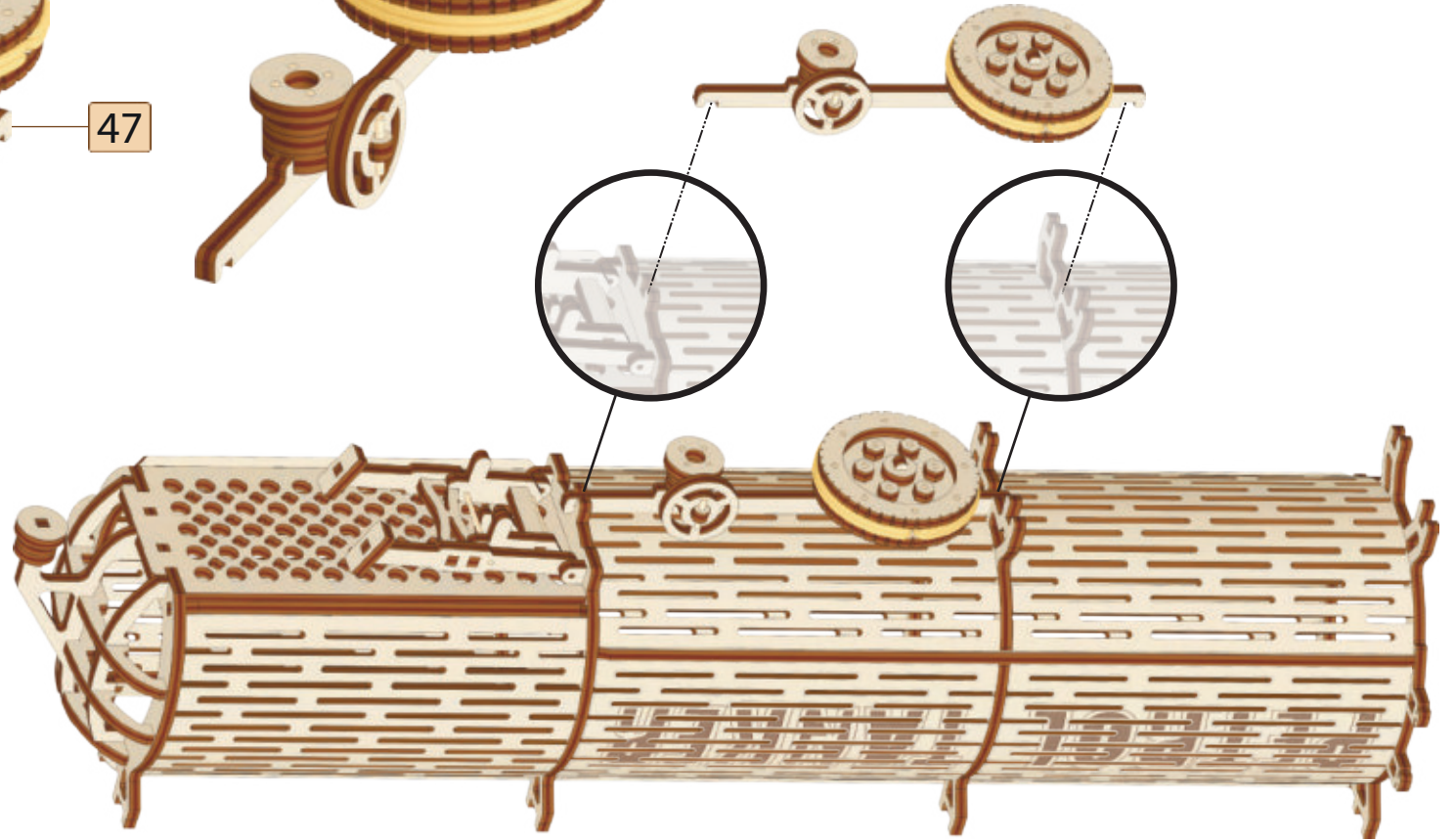
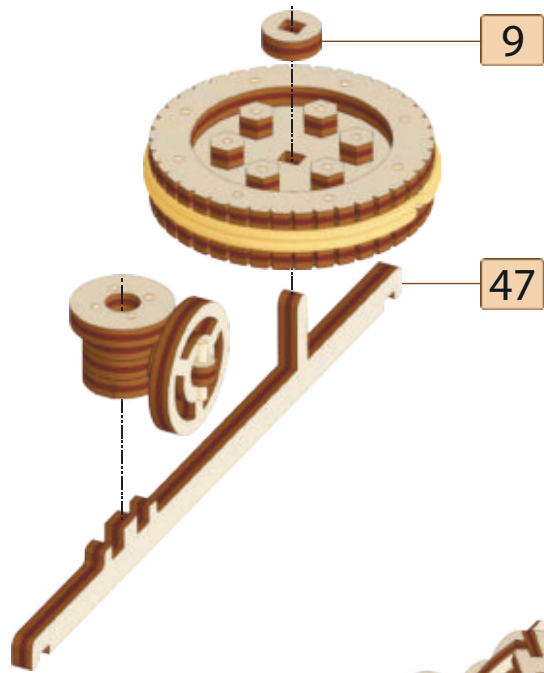
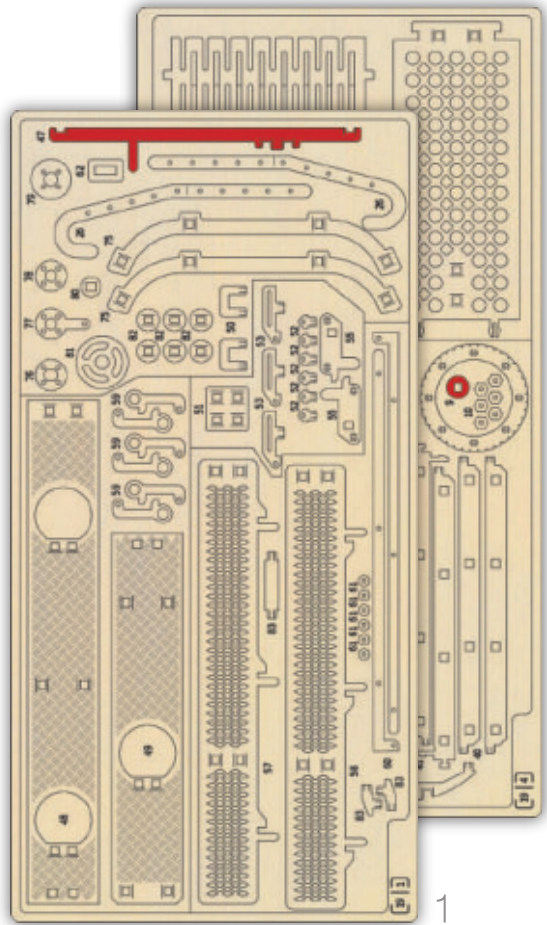

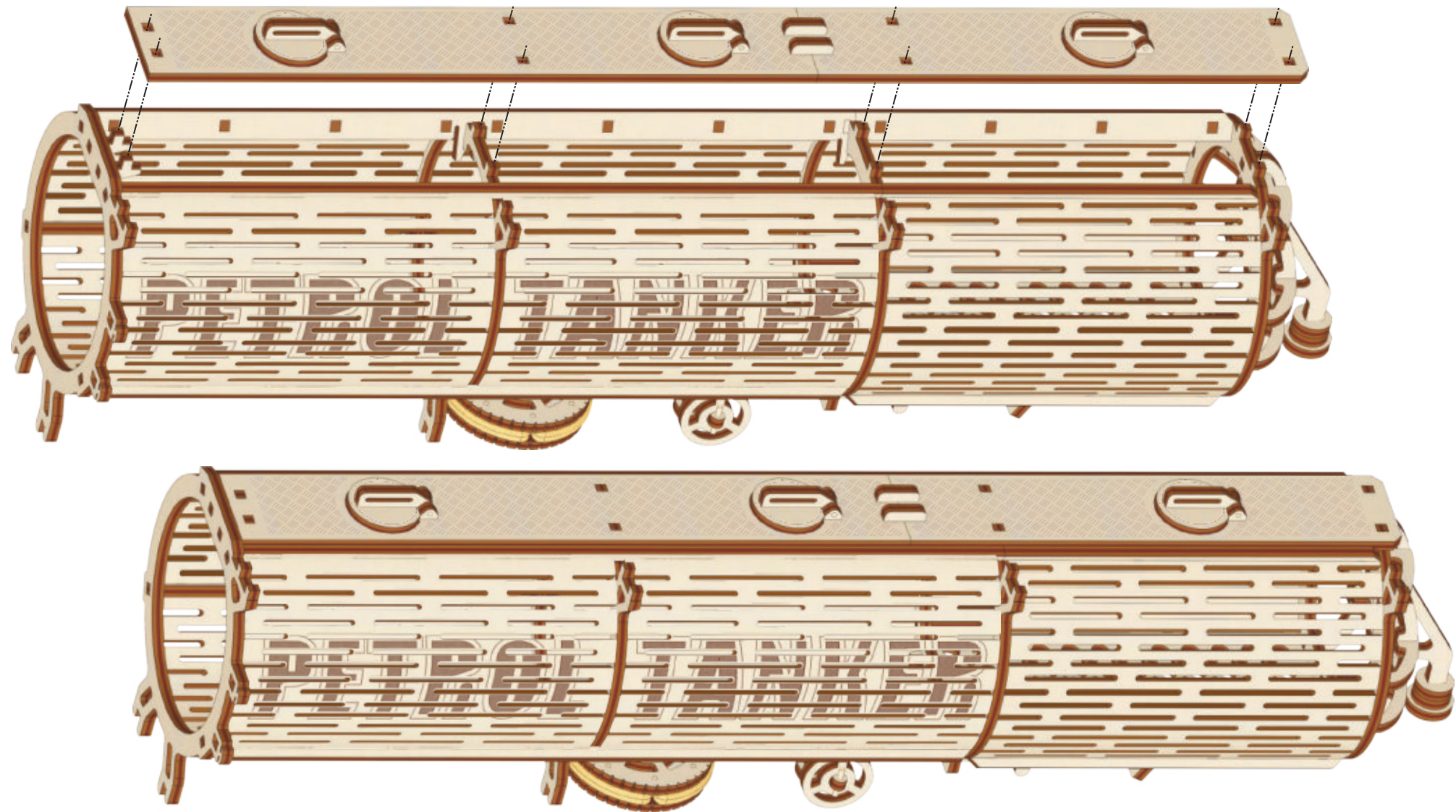

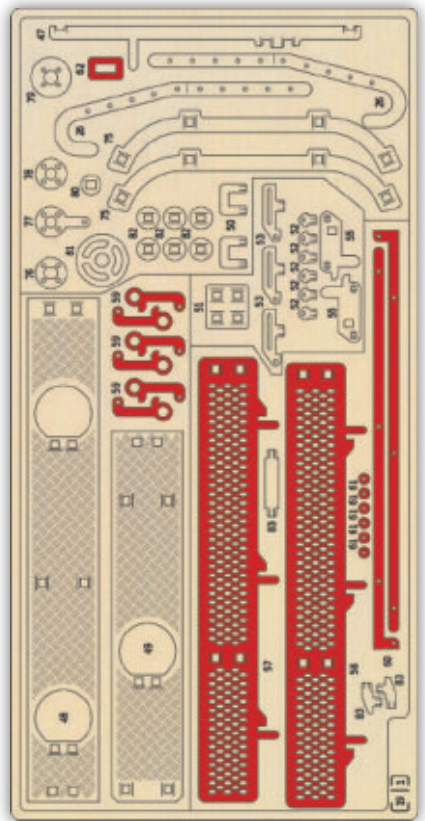

1

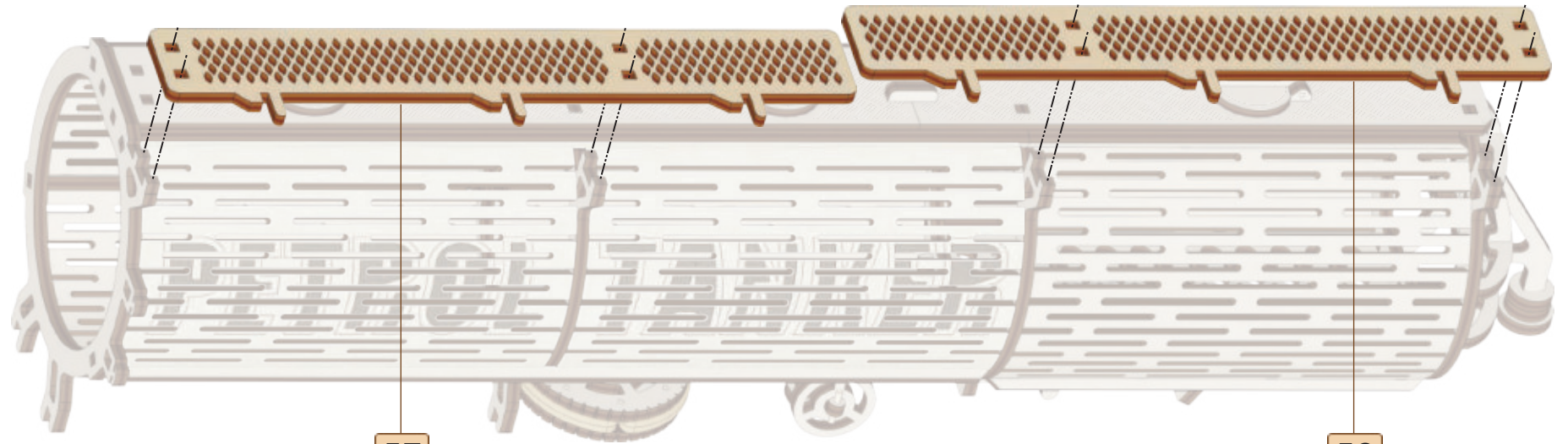

57

58

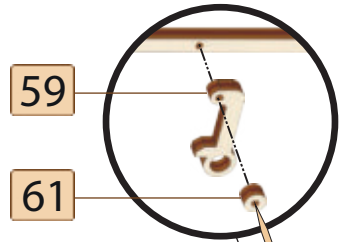

59

61

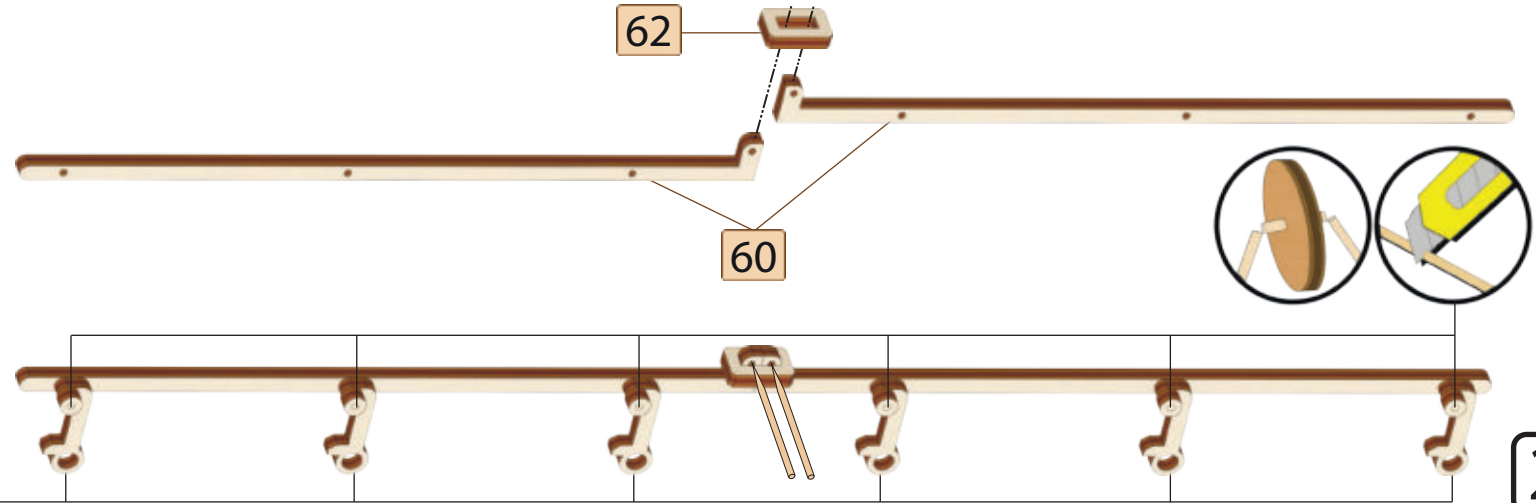

62

60

[22]

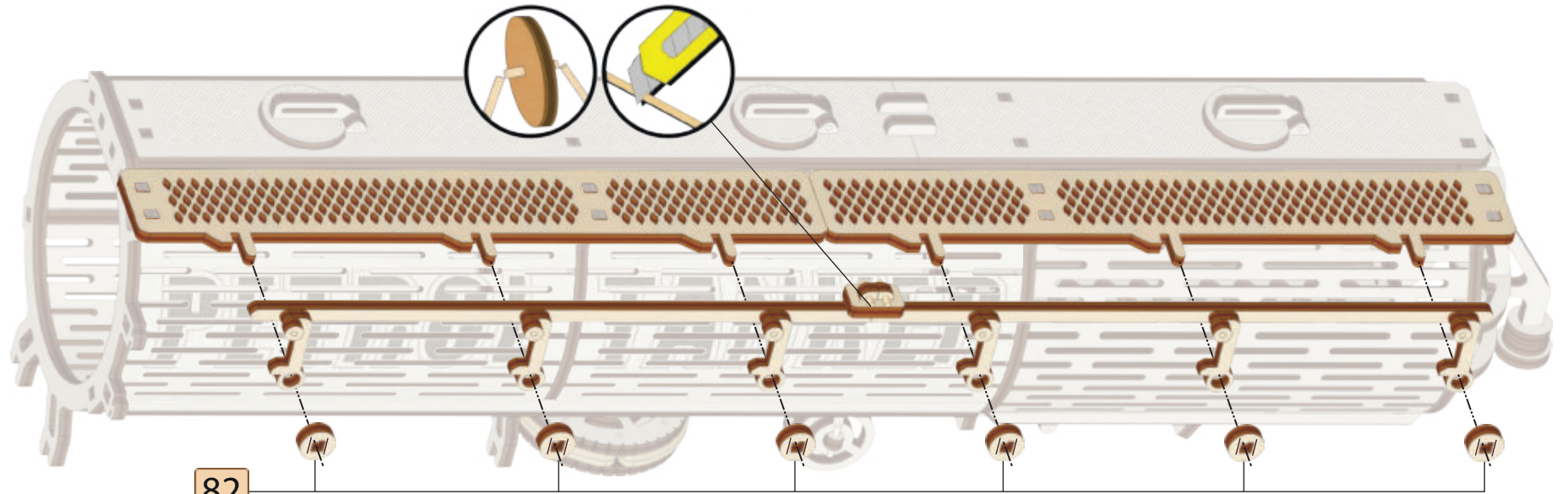
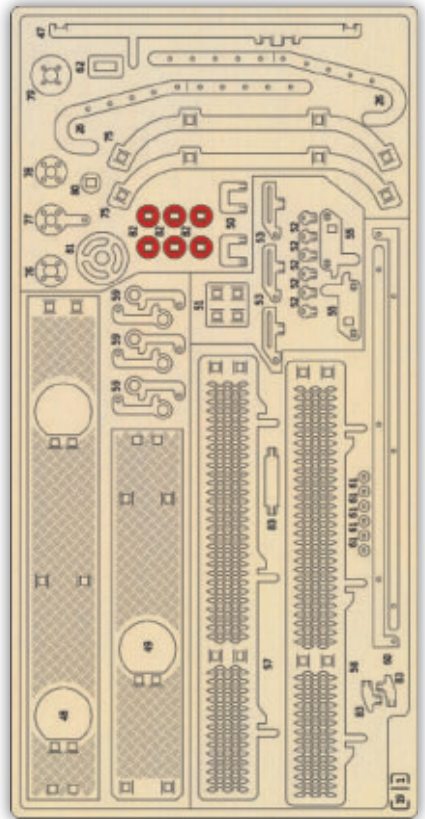

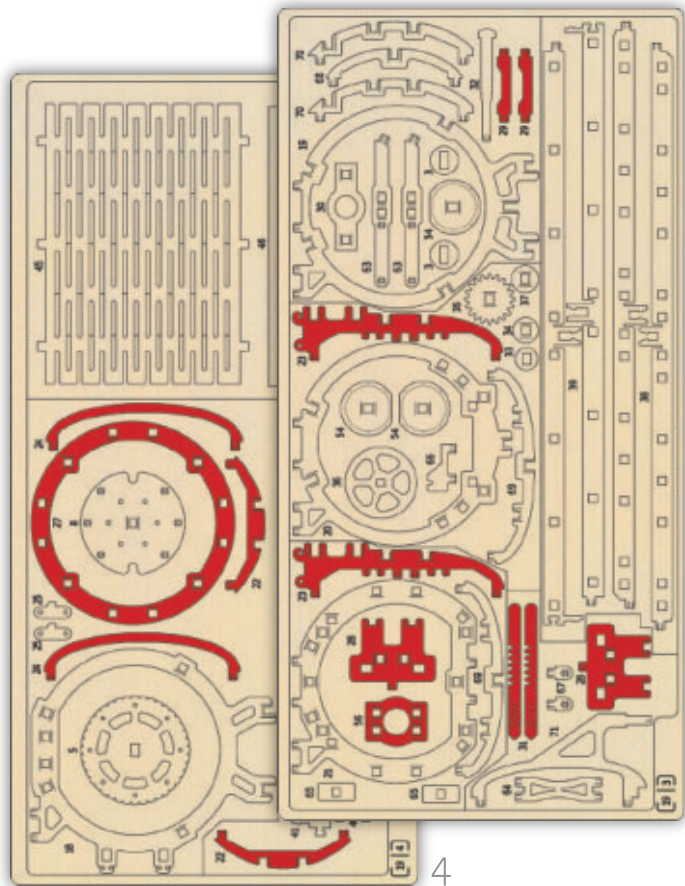

4

3

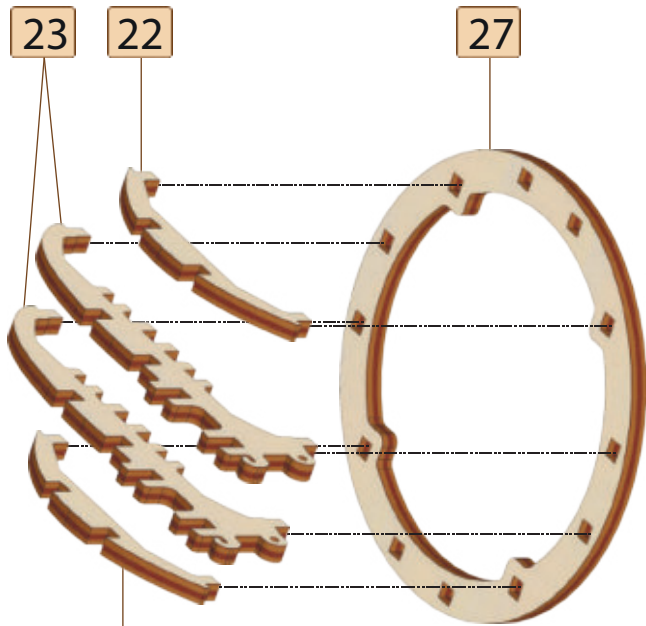

23

22

27

22

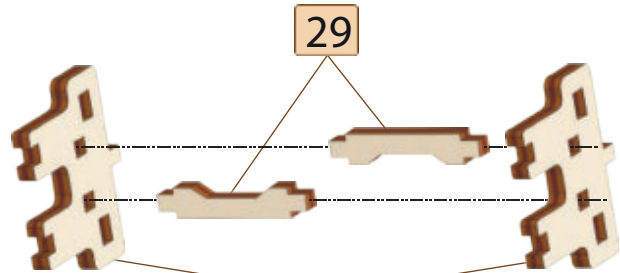

29

28

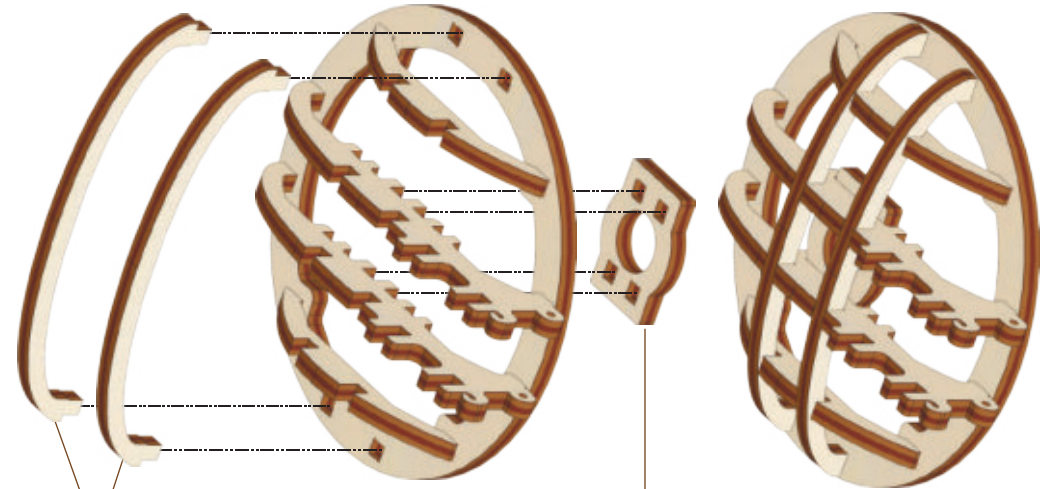

24

56

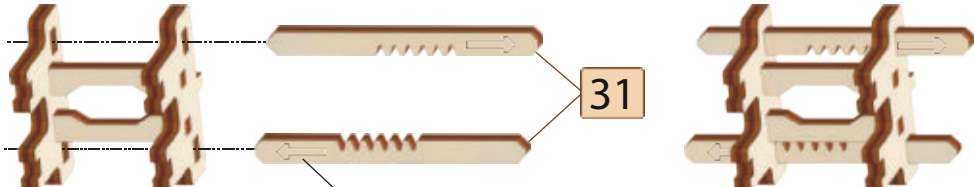

31

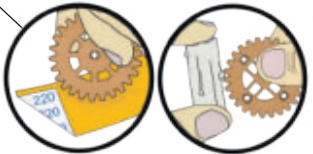

[24]

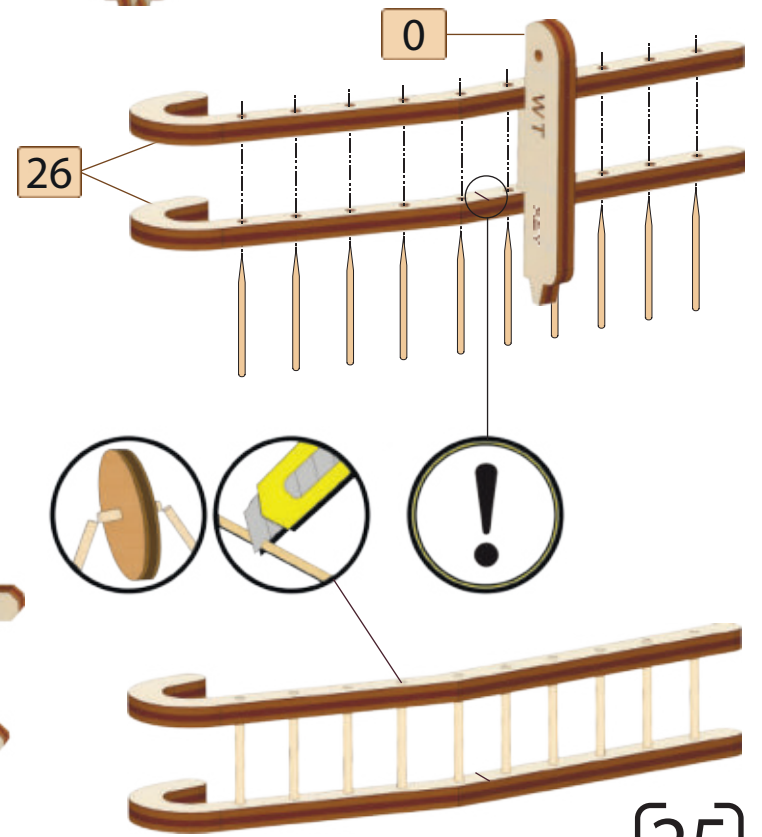
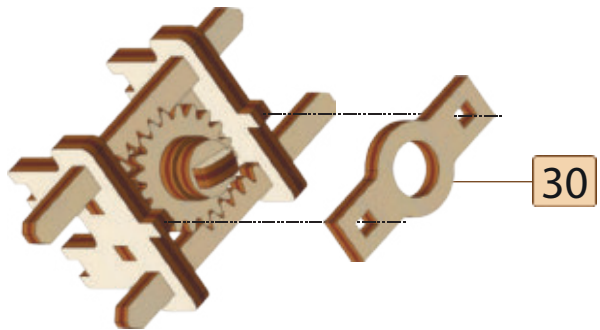
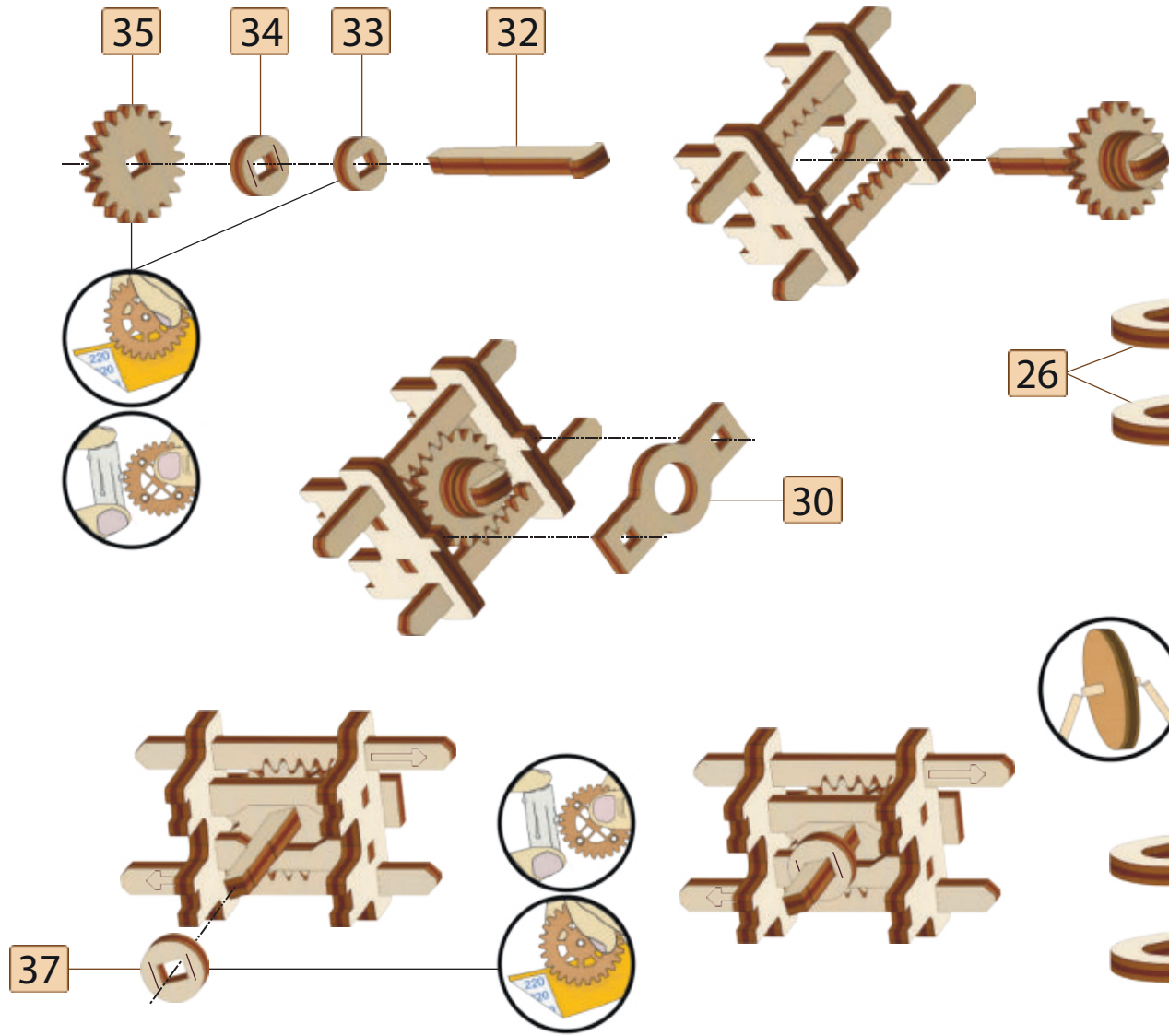
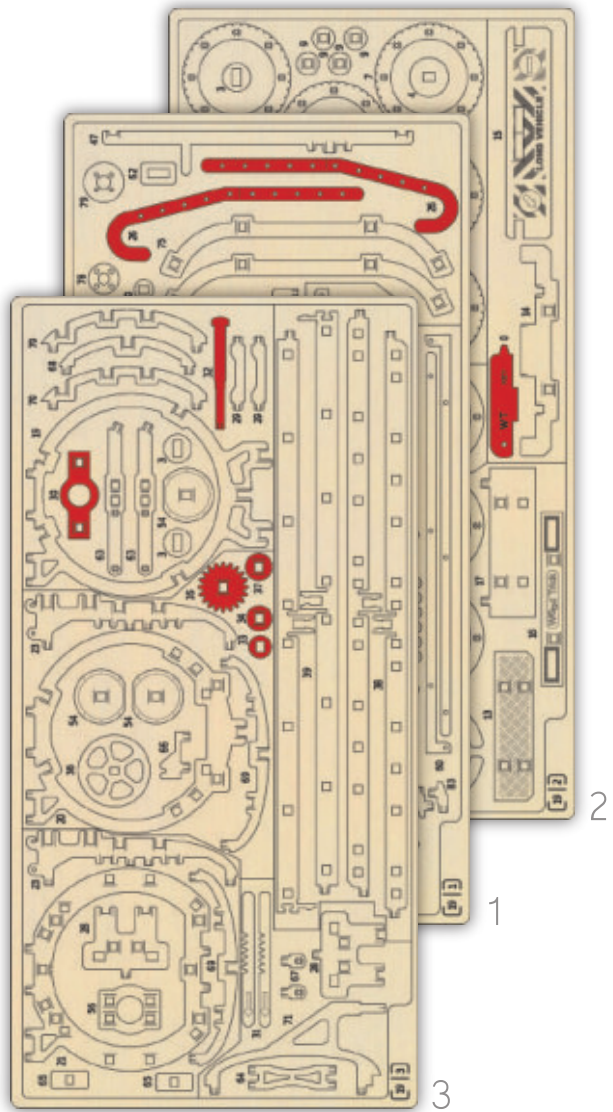

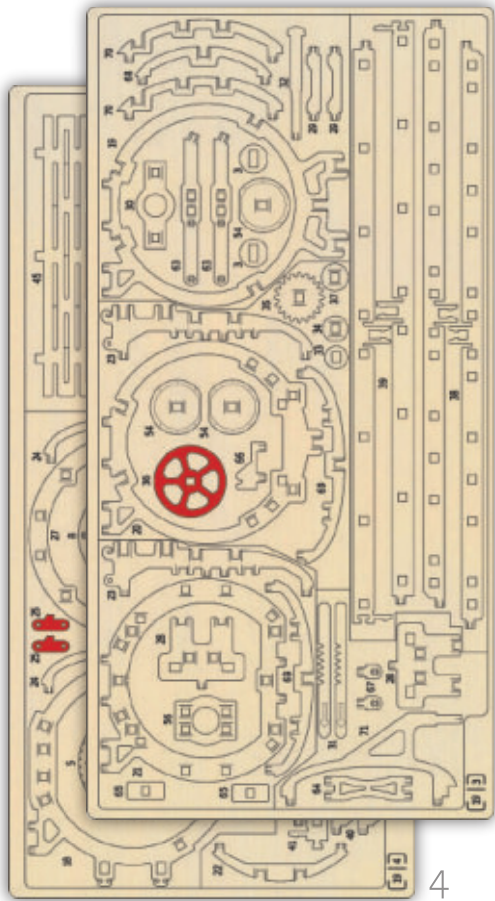

3

4

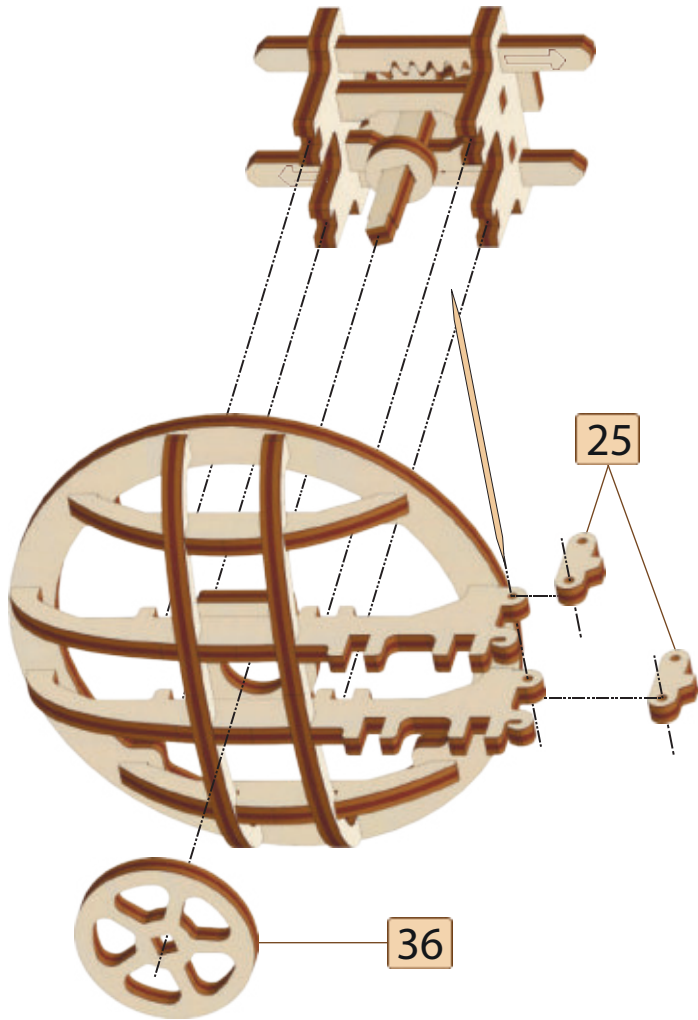

25

36

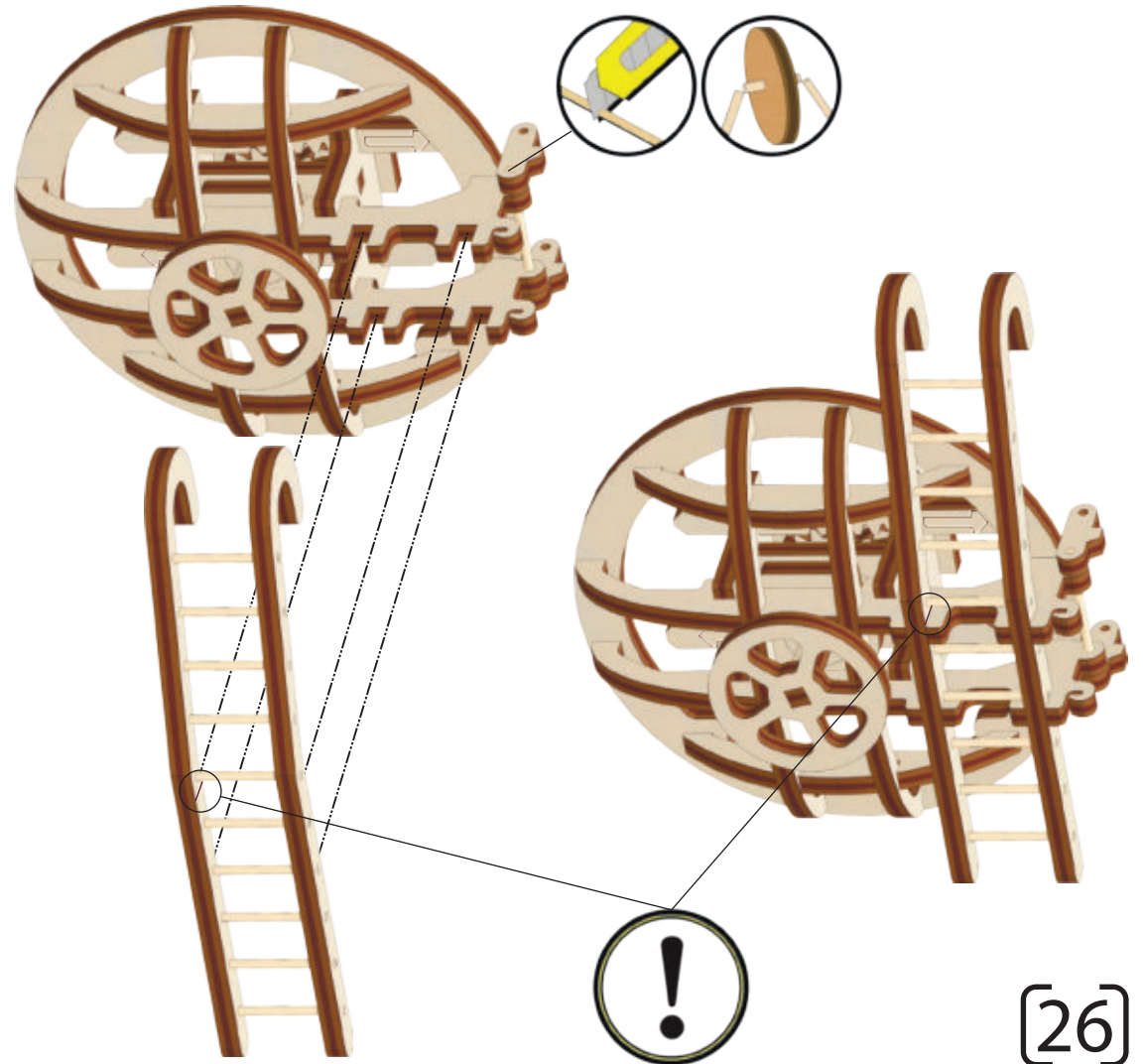

[26]

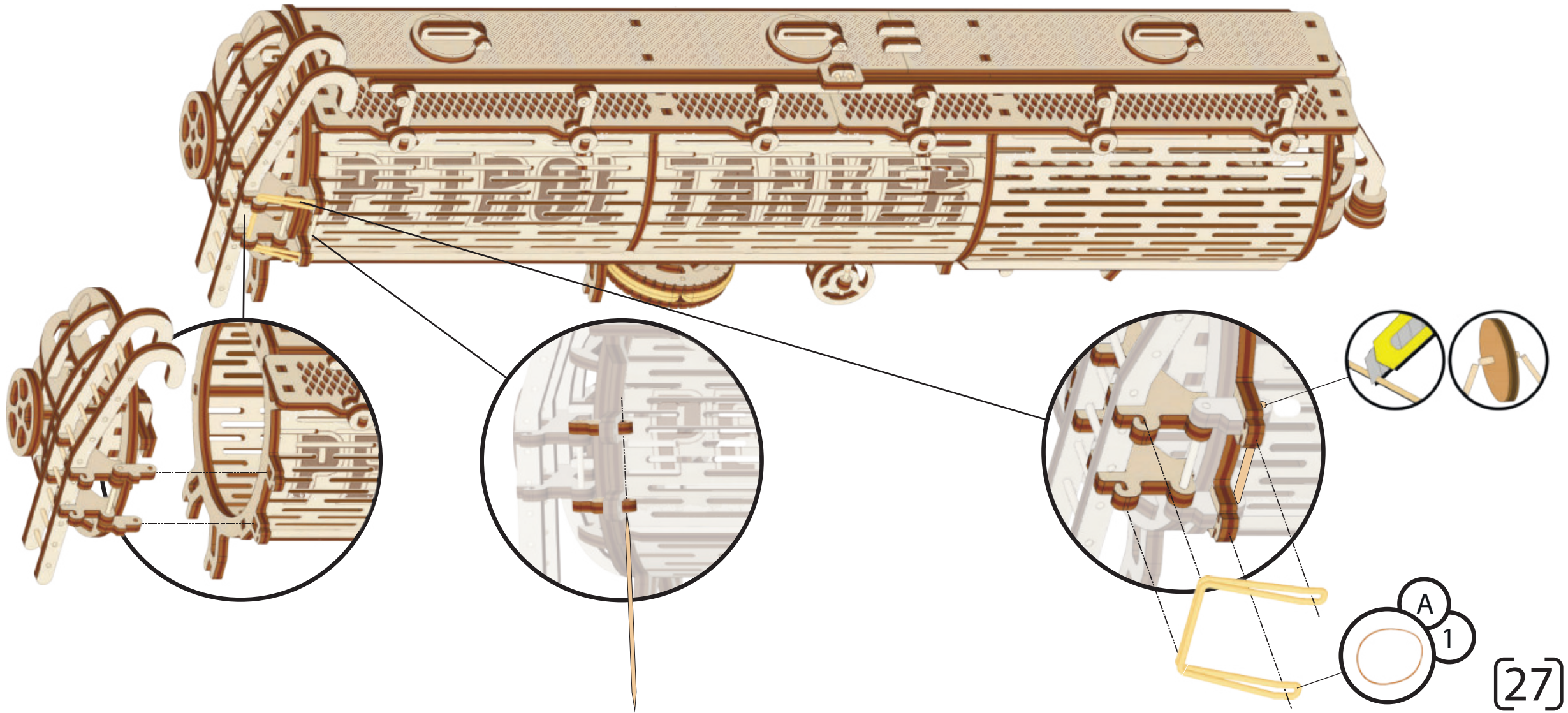

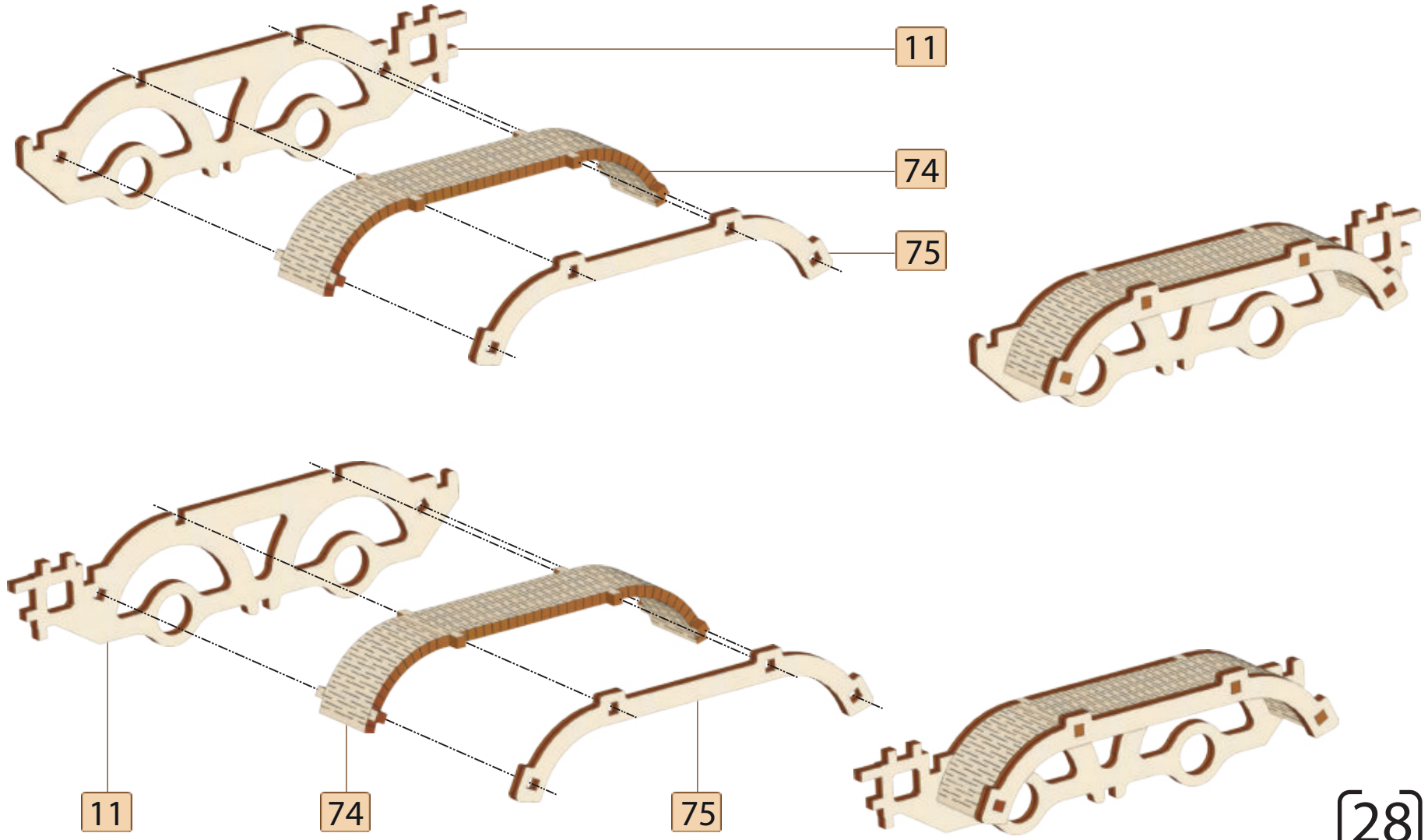
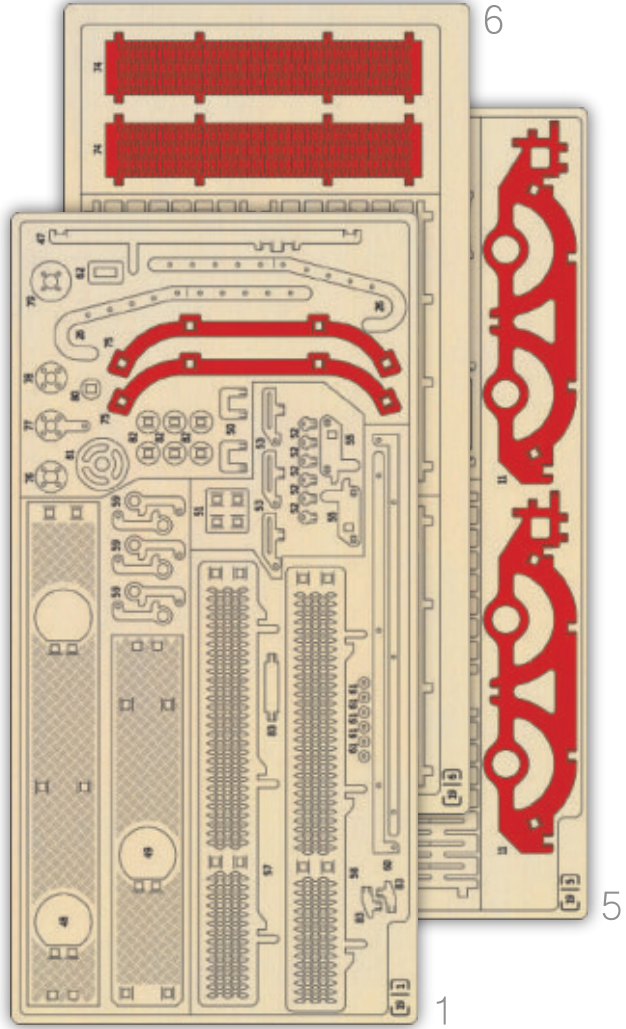

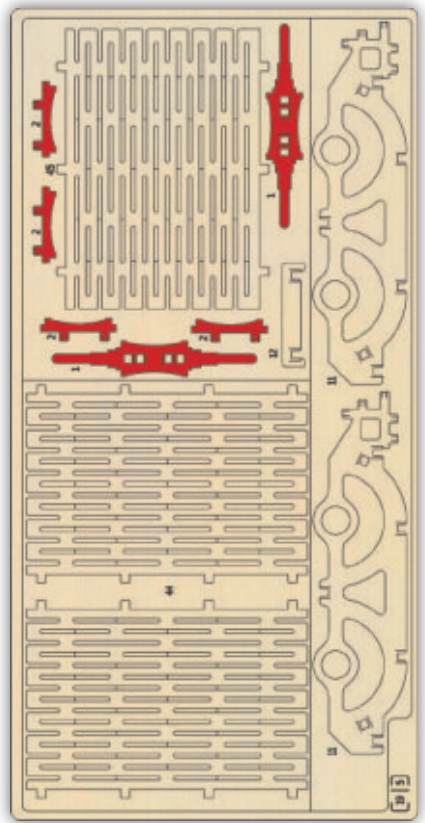

5

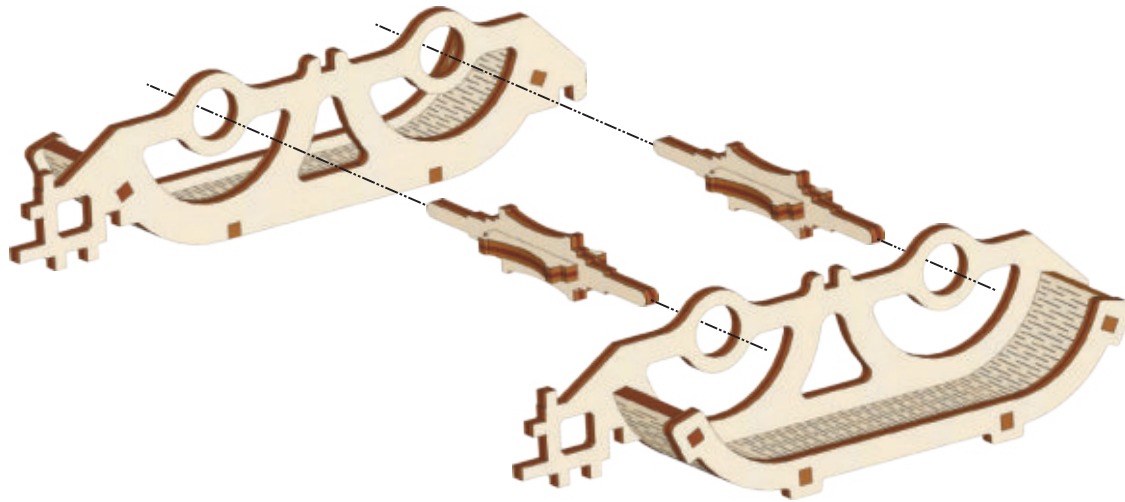
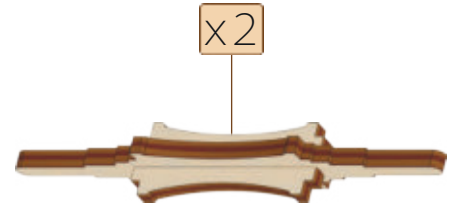
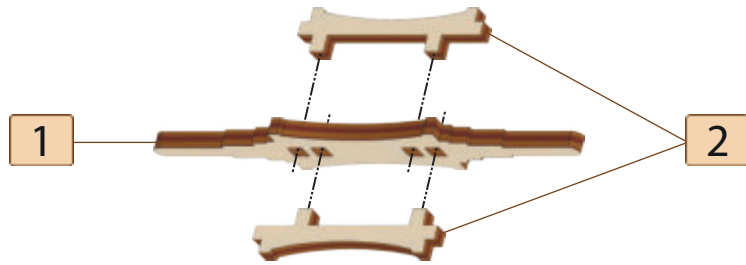

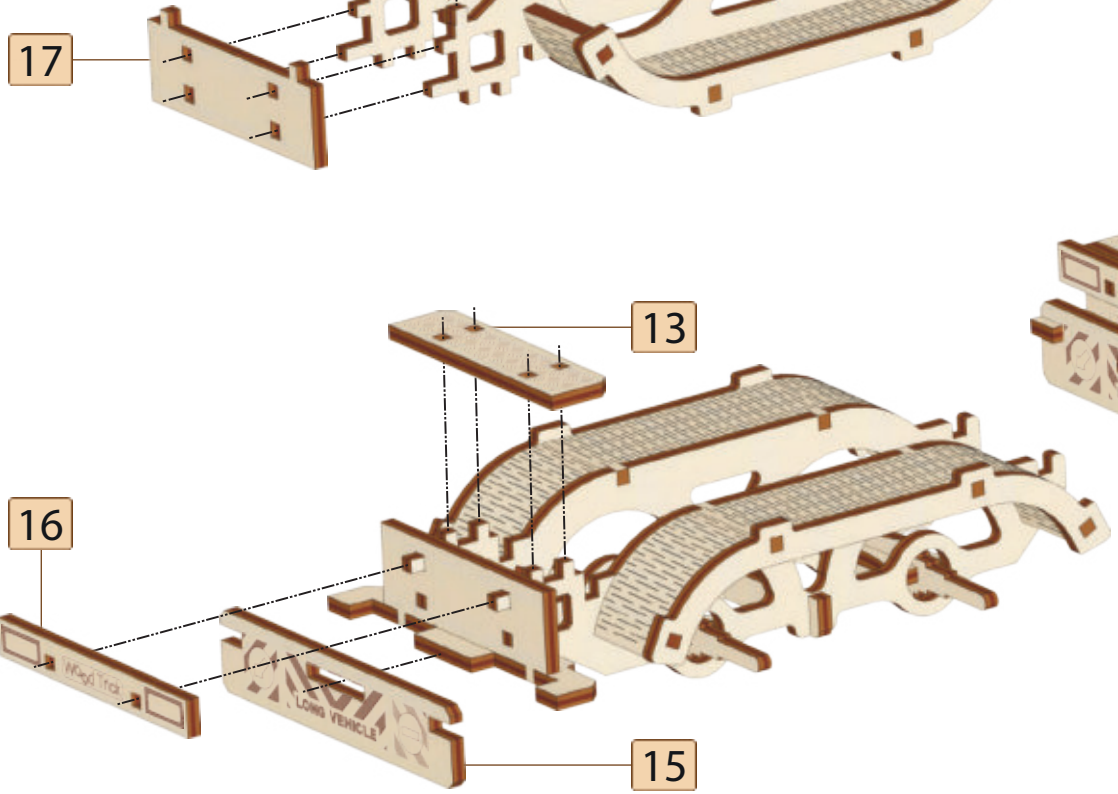
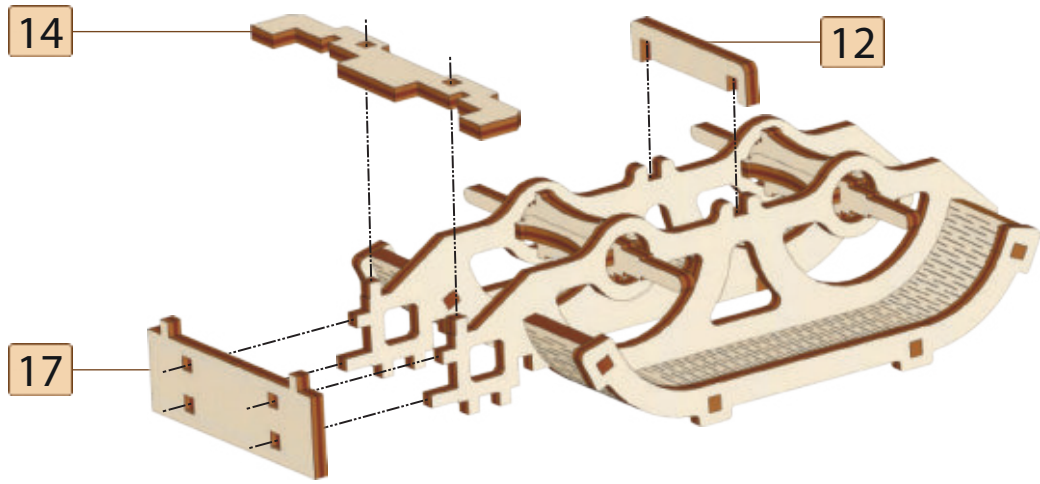
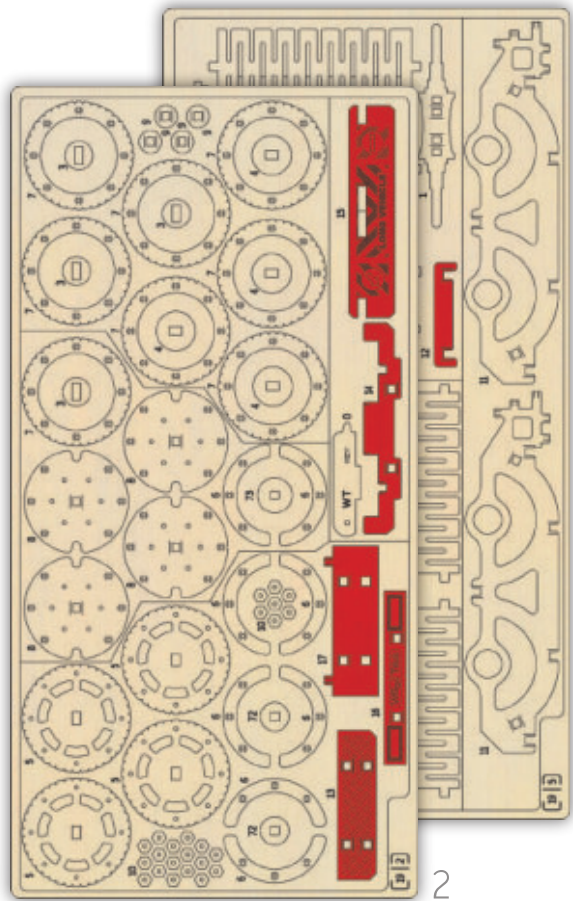

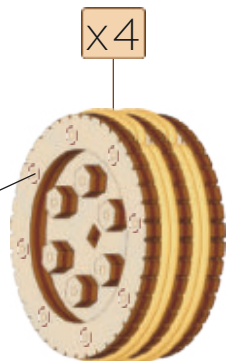
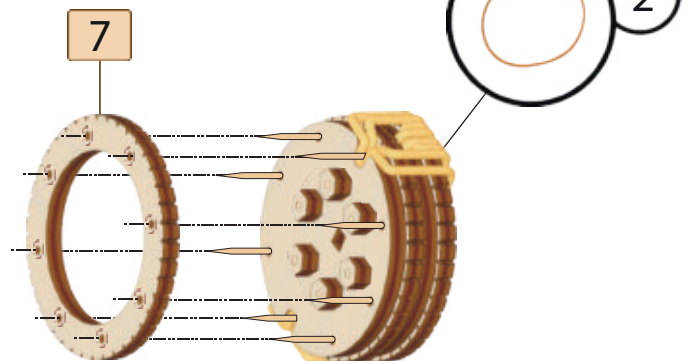
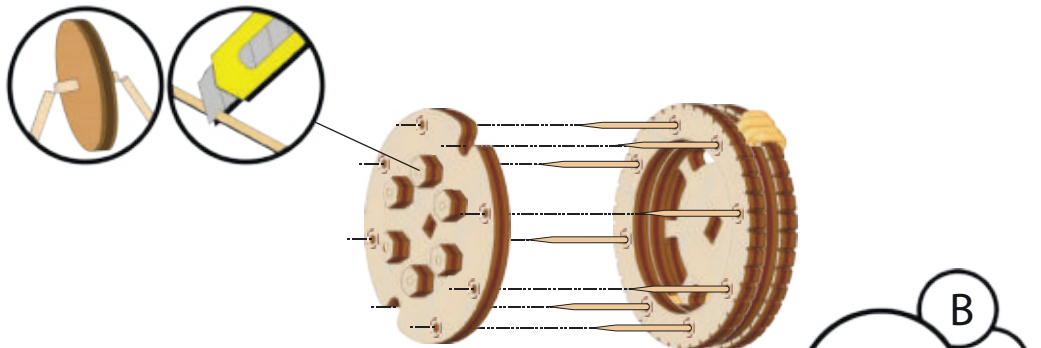
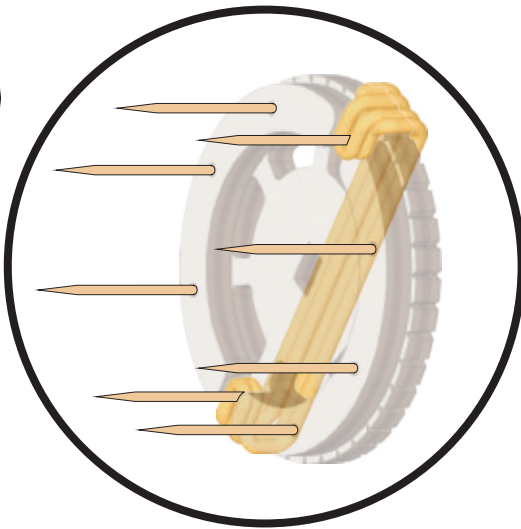
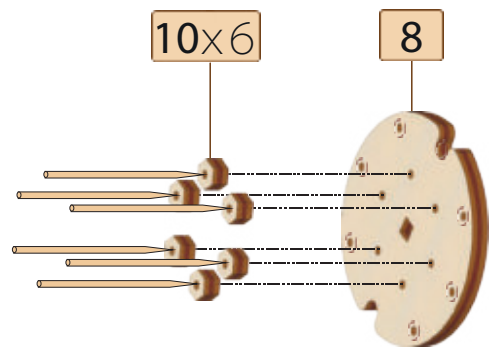
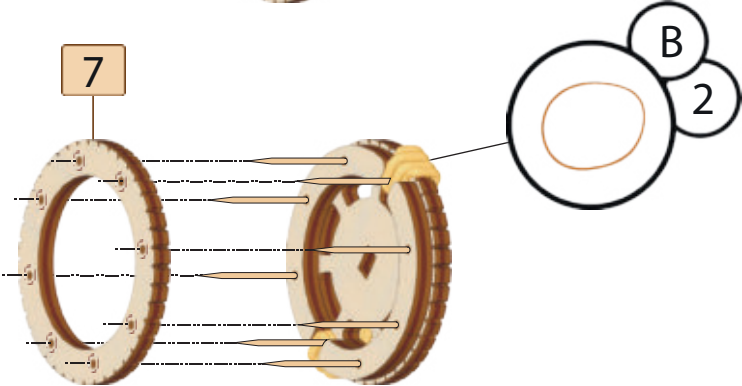
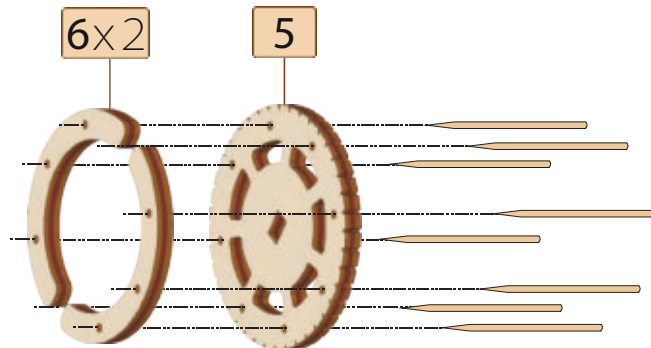
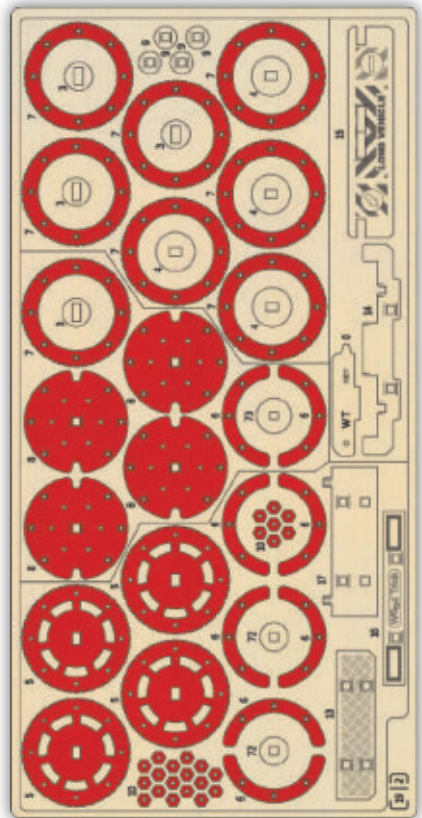

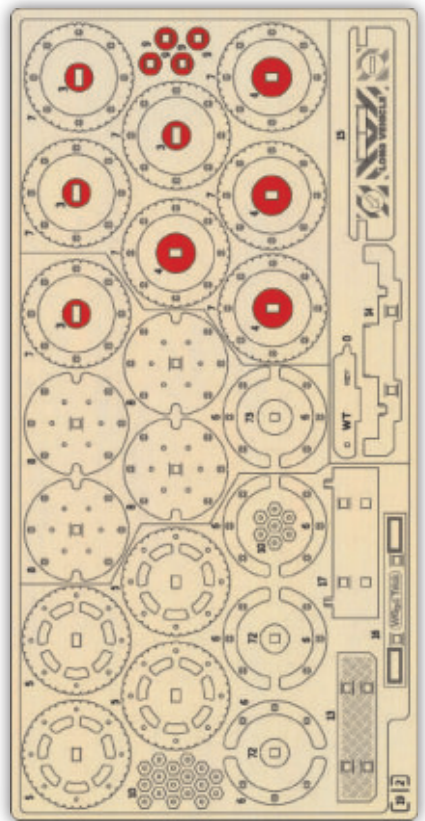

2

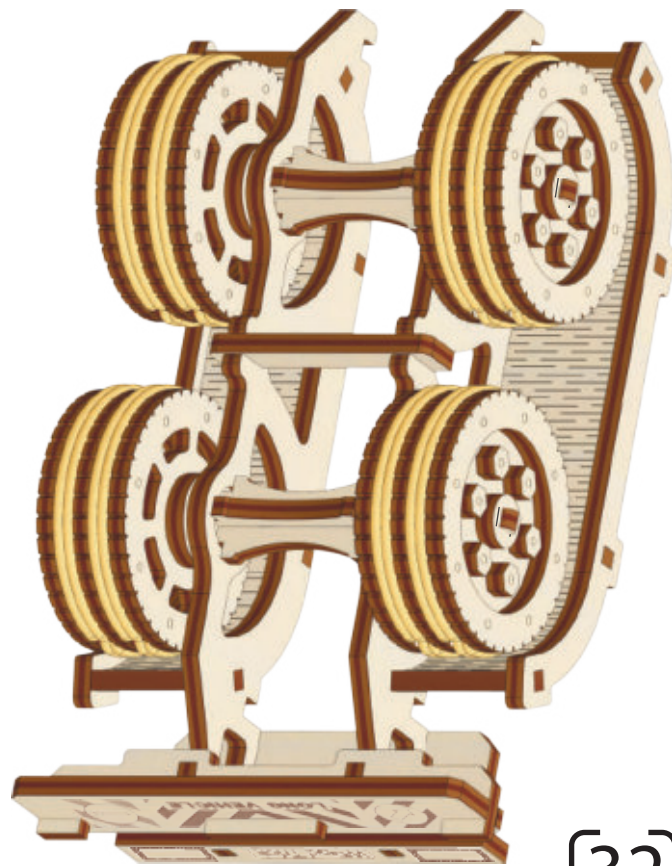
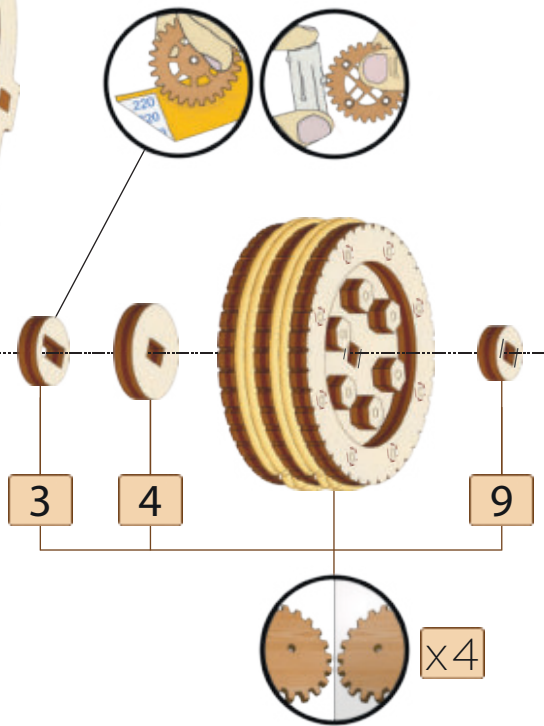
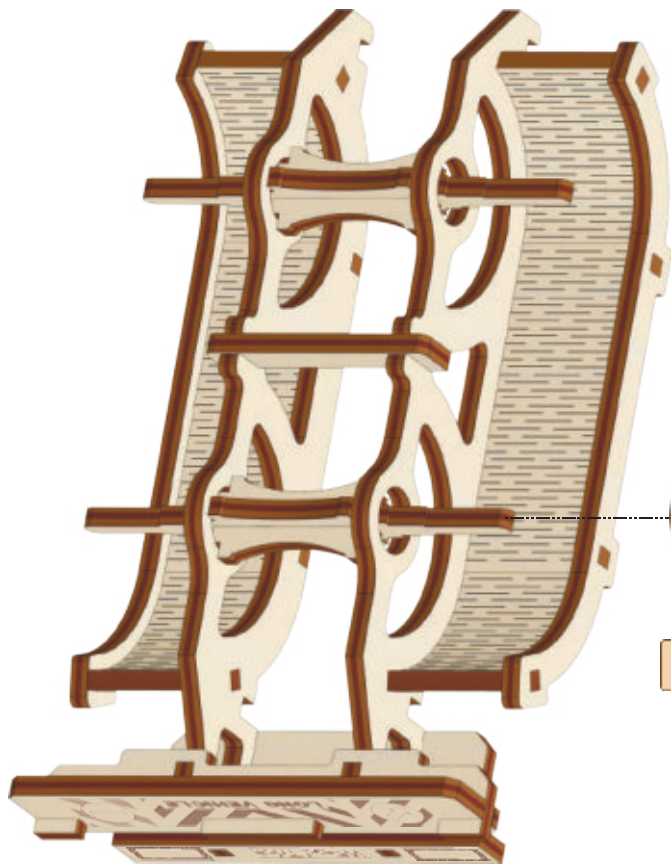

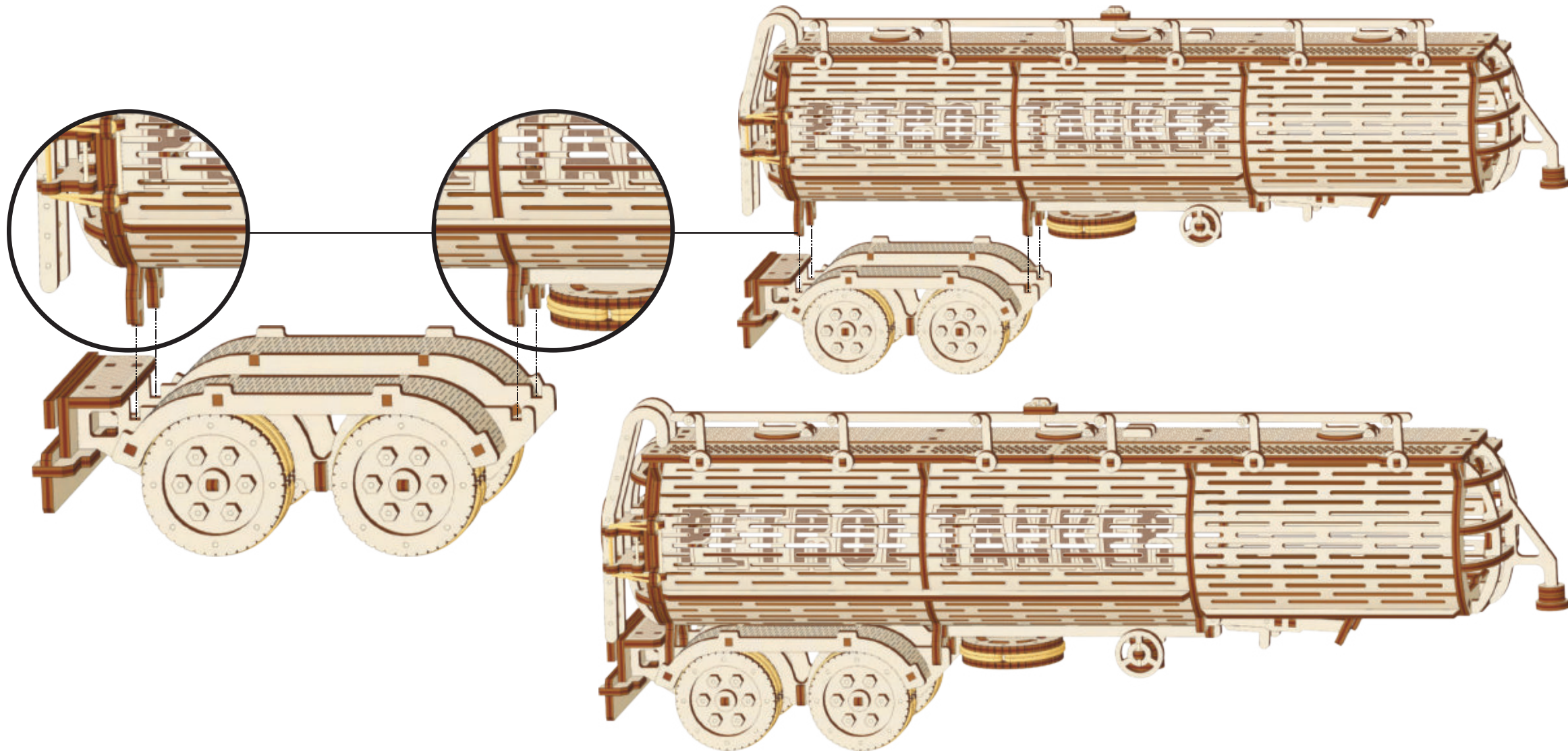

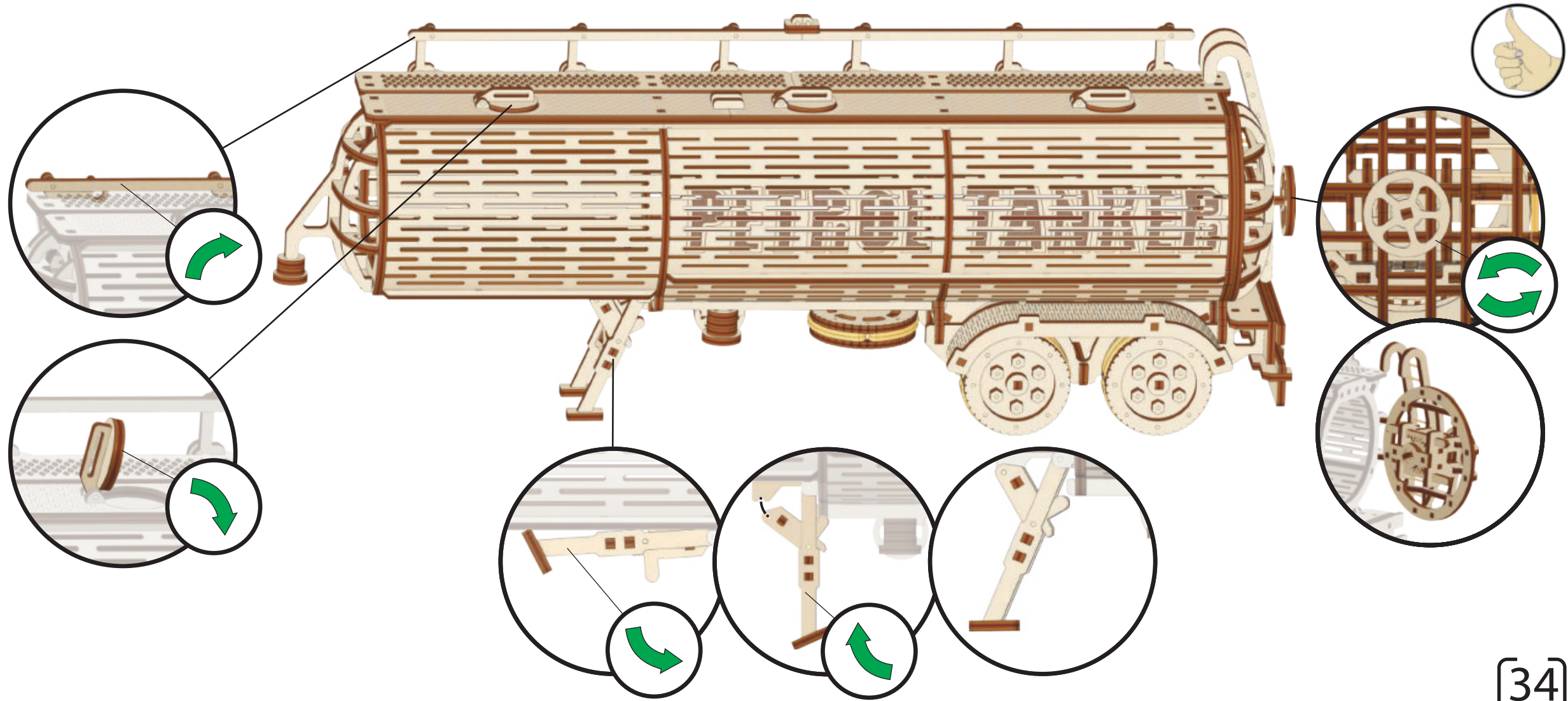



COLLECT A SET OF ADDITIONS

