



Booklet available in English on  
Heft in deutscher Sprache erhältlich auf  
Livret disponible en français sur  
Libretto disponibile in Italiano su  
Folleto disponible en español en  
如需中文版手册, 请访问

[LEGO.com/service/buildinginstructions](https://www.lego.com/service/buildinginstructions)



## WELCOME

We are delighted to introduce you to our latest Modular Building set, the 16th building in this popular series. Whether you are building one for the first time or adding to your collection, we hope it gives you hours of LEGO® building fun.



Chris McVeigh, LEGO® Designer



## BUILD A STORY

LEGO® Designer Chris McVeigh, and the rest of the LEGO design team, wanted to ensure you could build a story as well as a model with this Police Station set, that's why it's packed with intricate details and hidden features that fuel the imagination. In Chris's narrative, the local newsstand operator has fallen on hard times, but he's dreamt up a sweet scheme to generate headlines and sell papers. Feel free to build further on this or start a completely different story of your own.





[LEGO.com/brickseparator](https://LEGO.com/brickseparator)

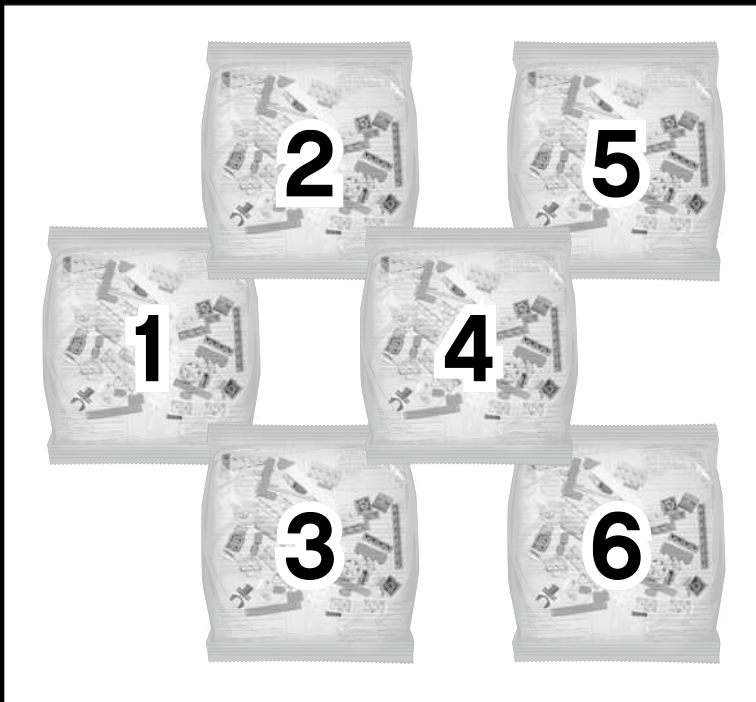



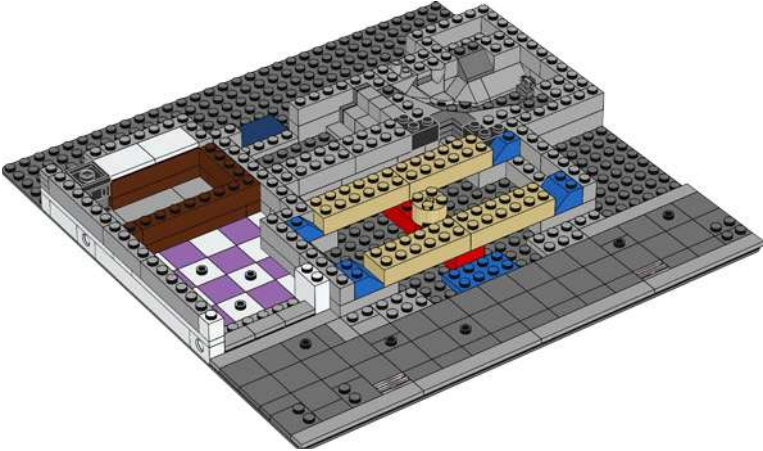
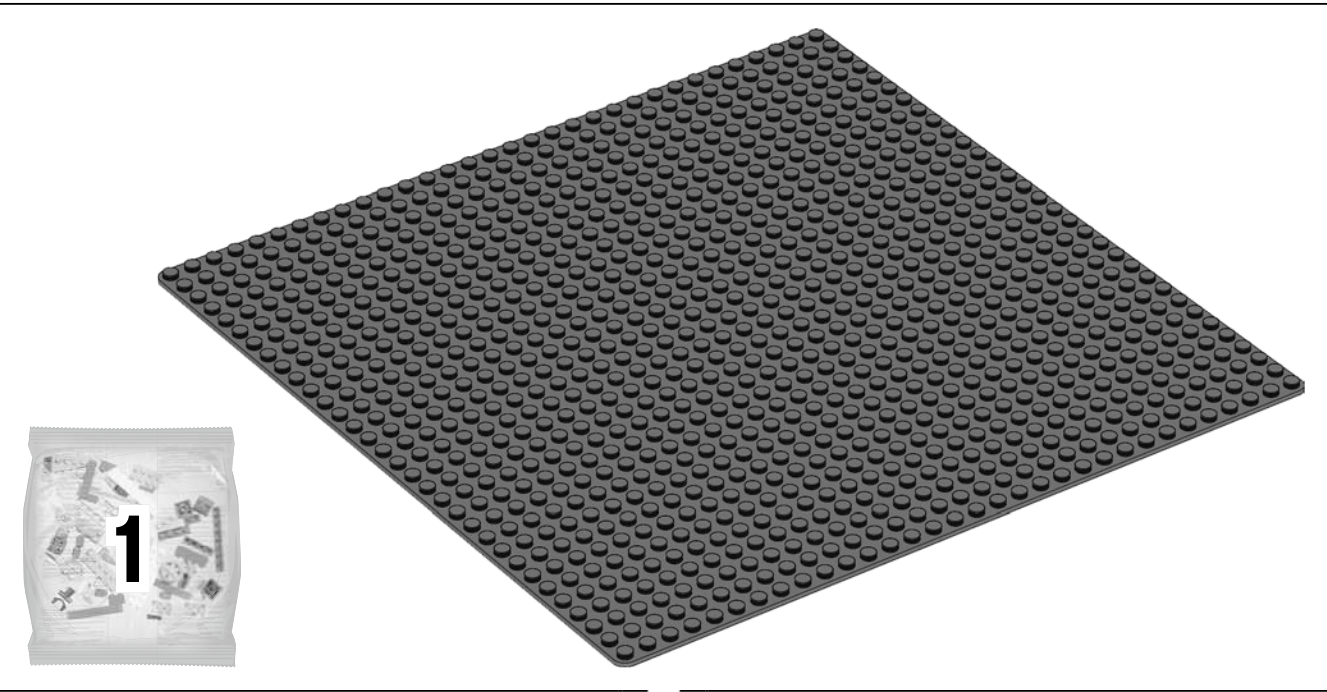

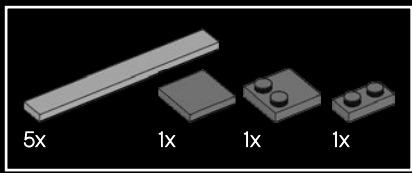

1

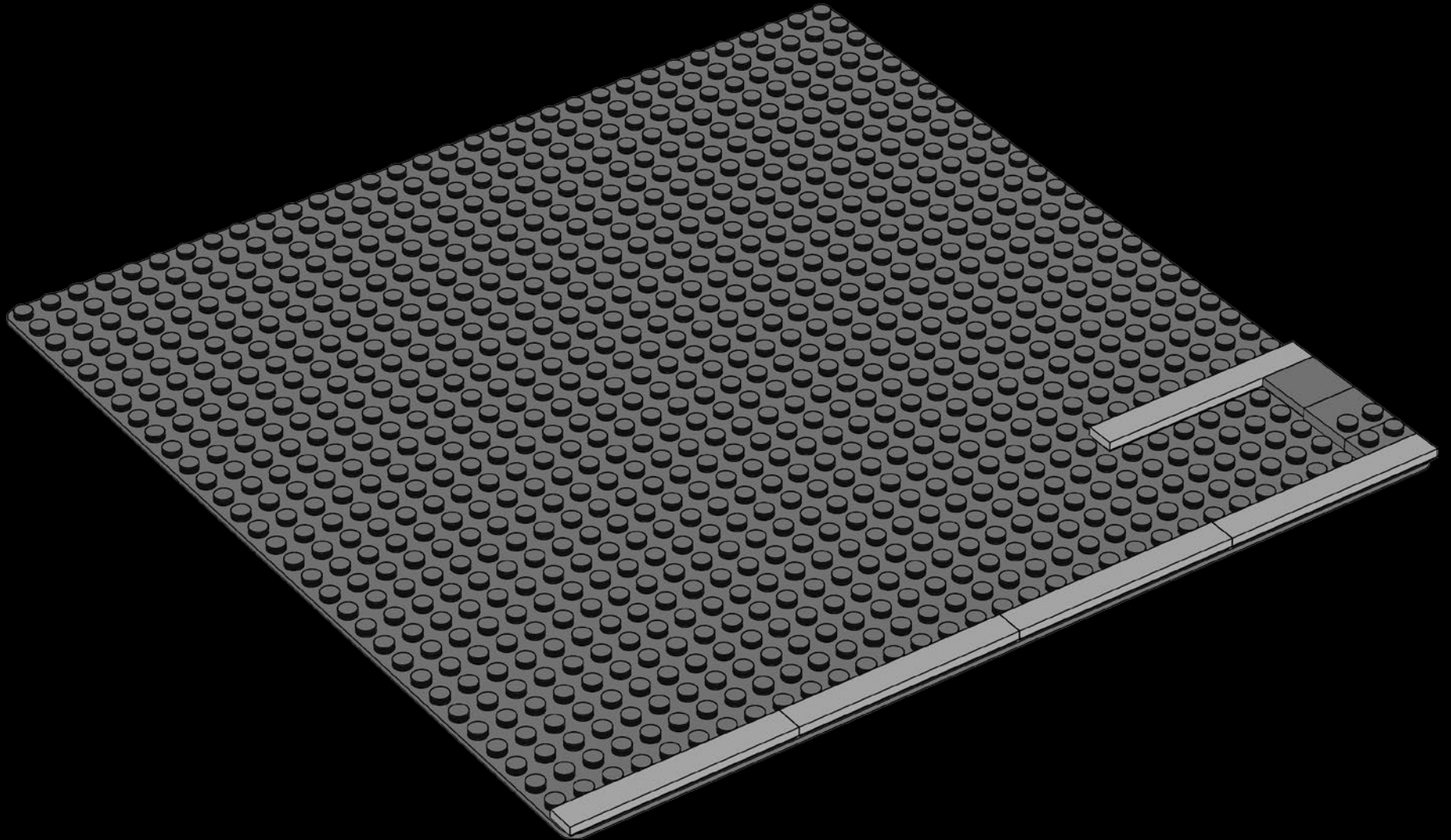



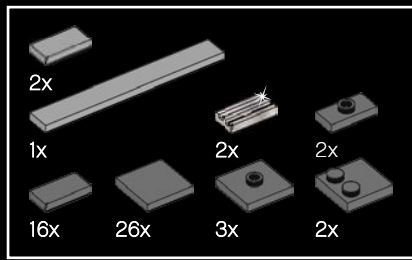

2

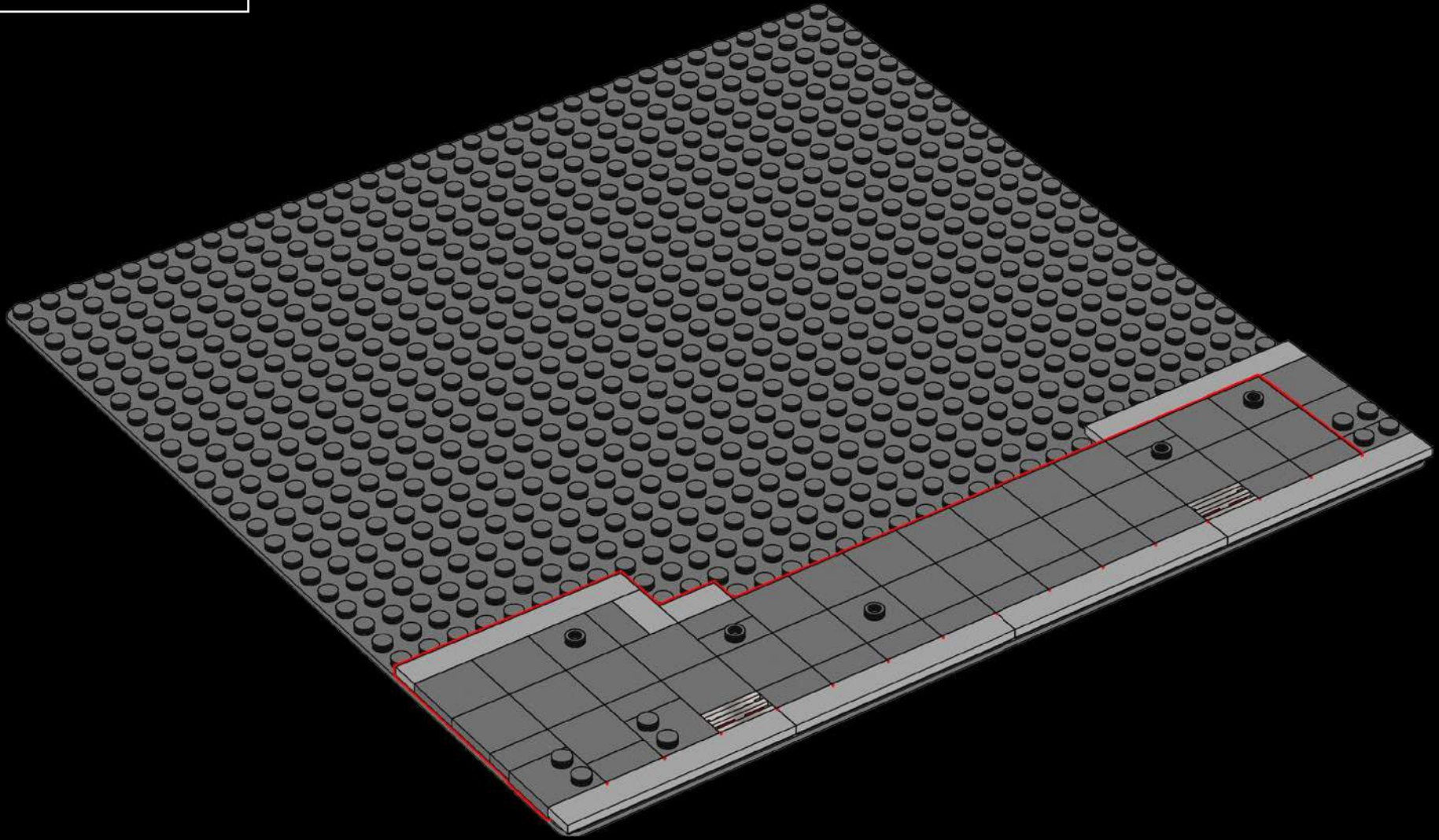





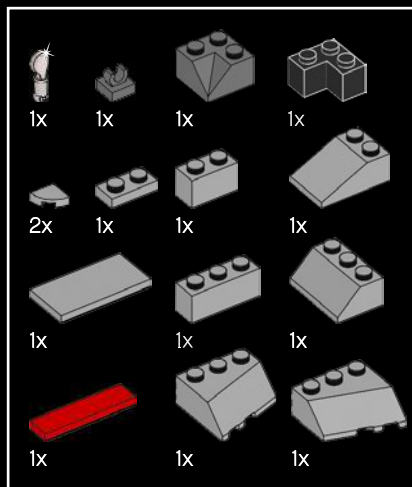

5

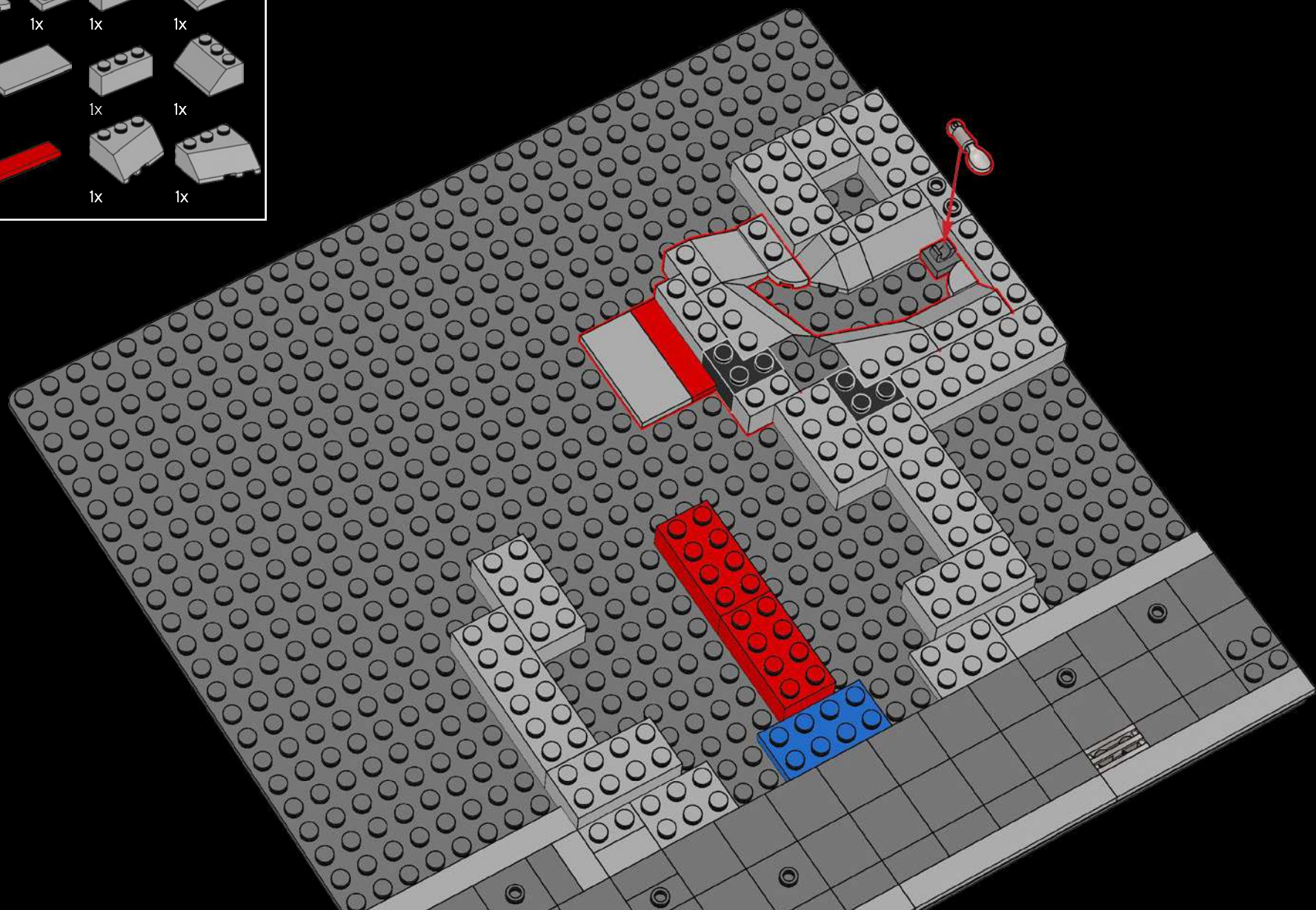

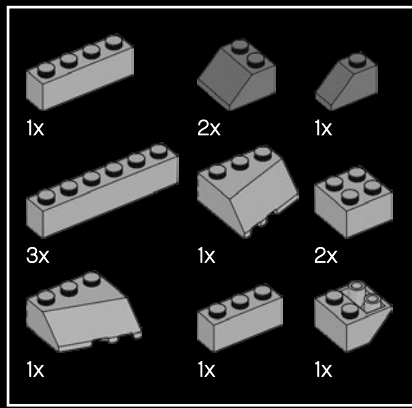

6

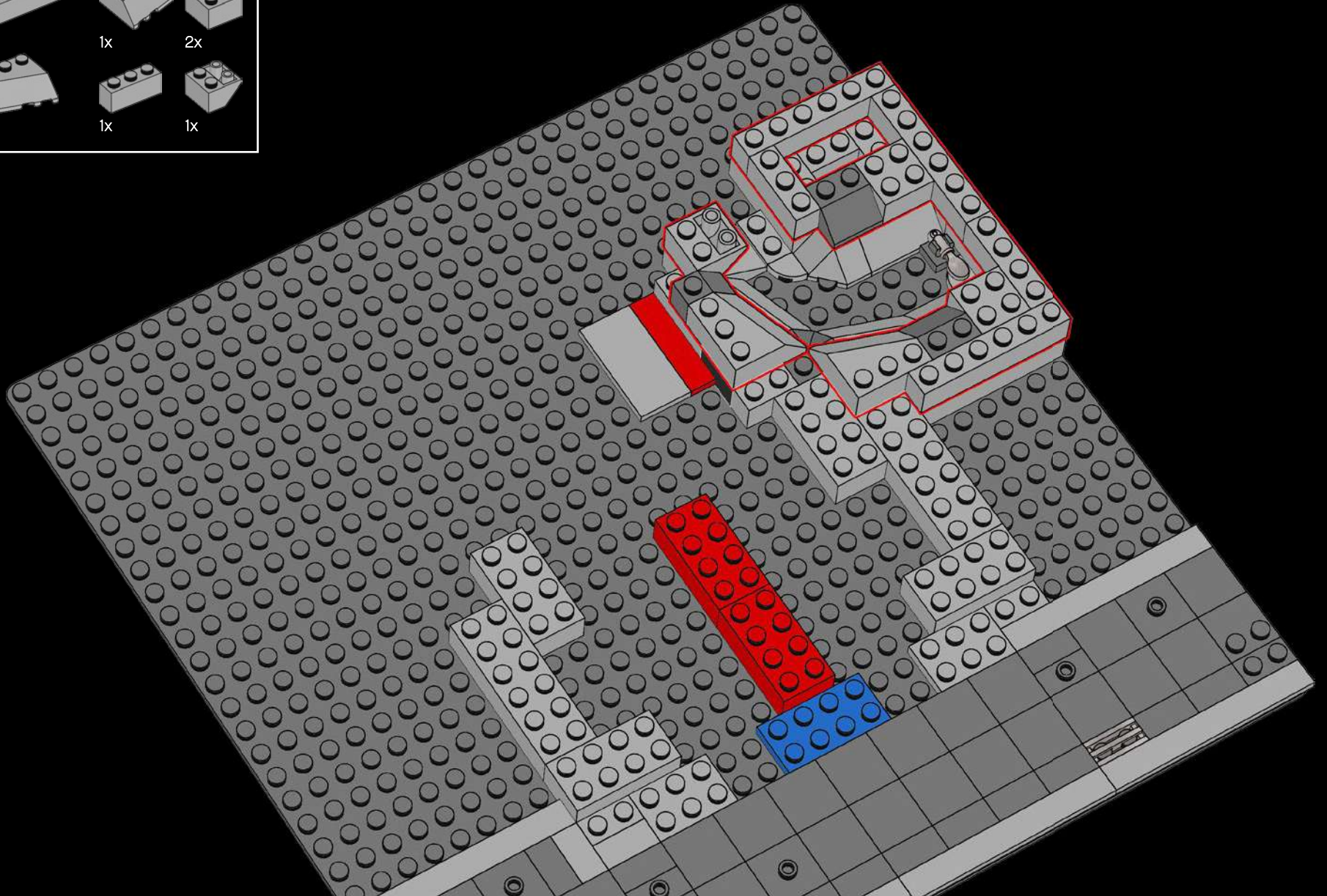

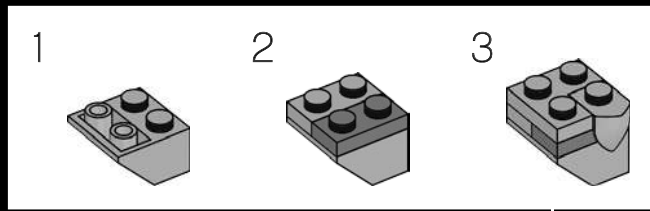
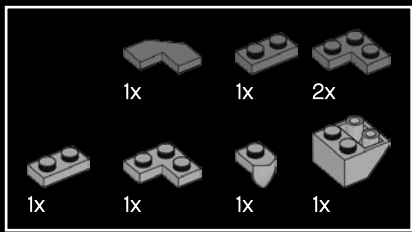

7

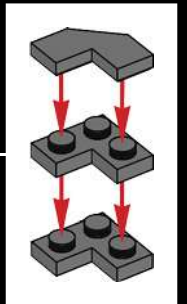
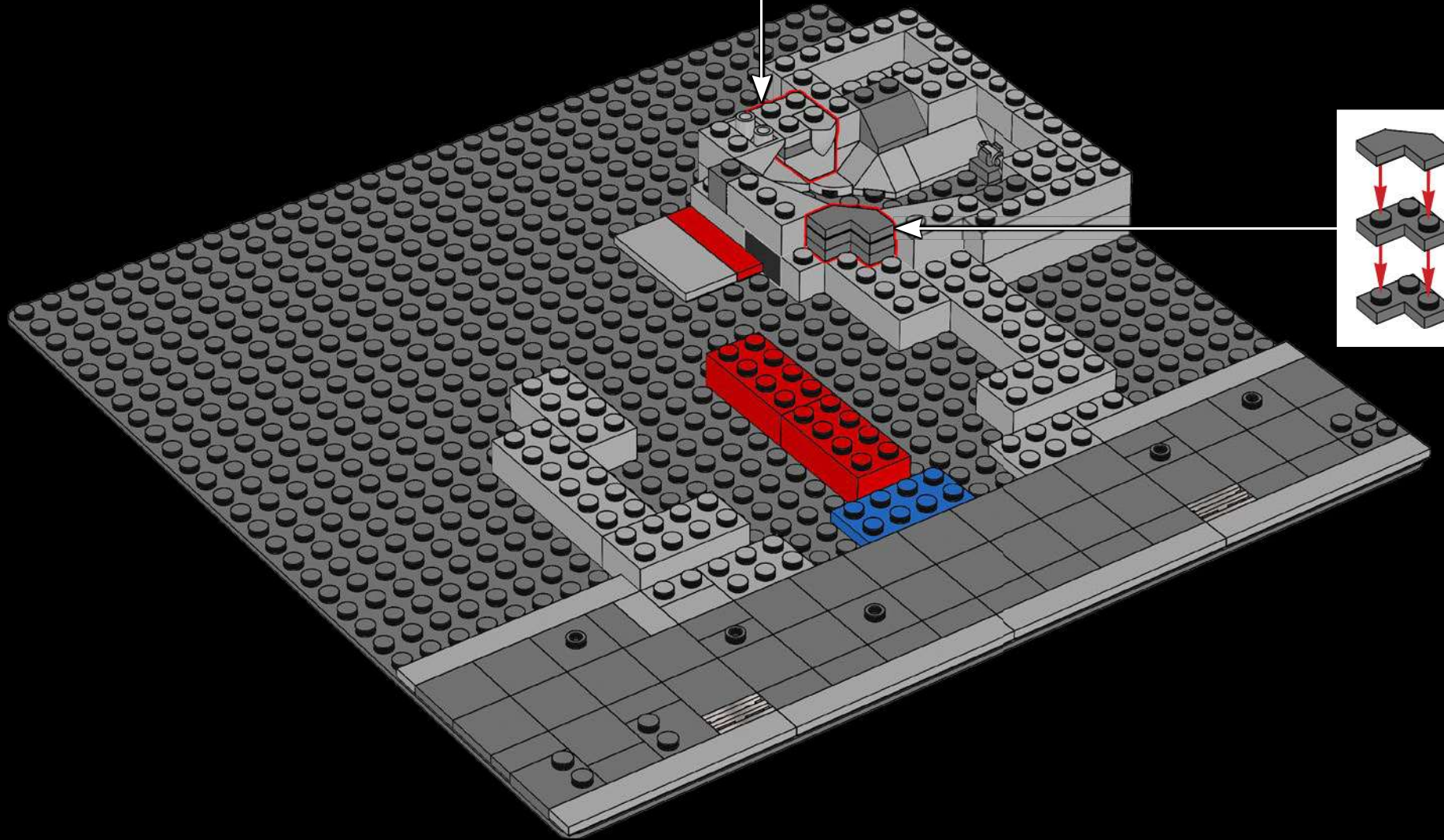

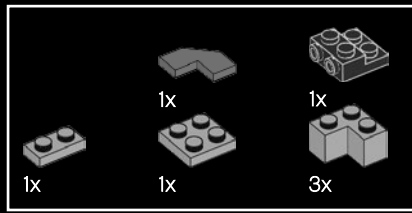

8

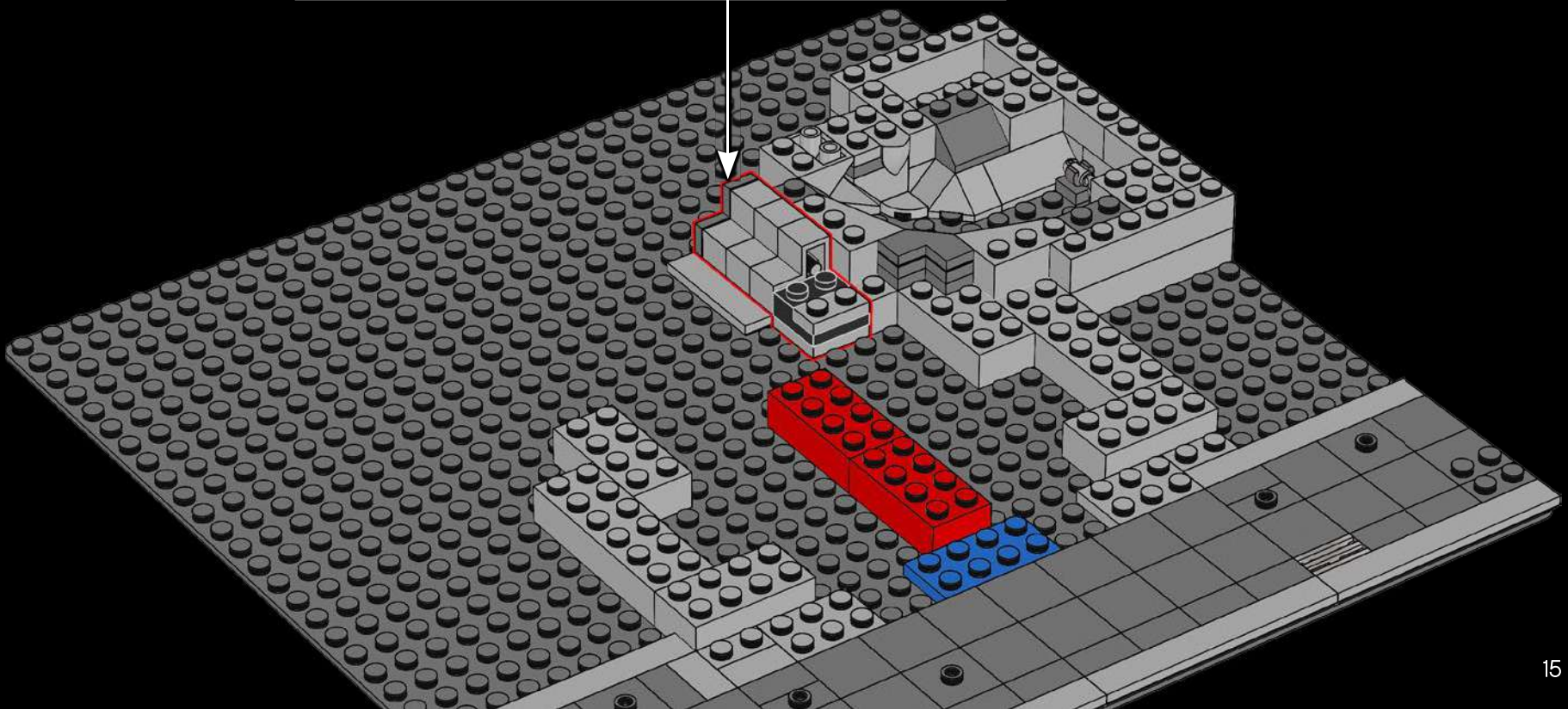
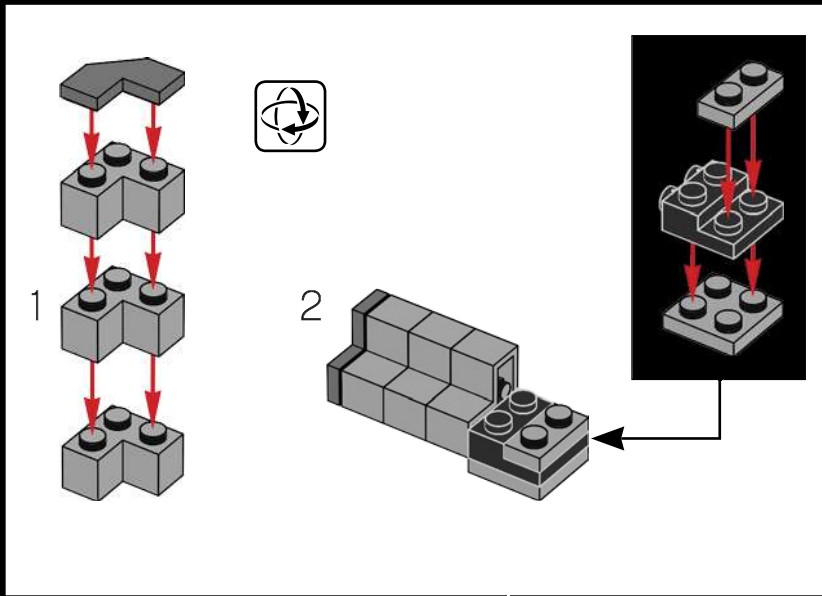

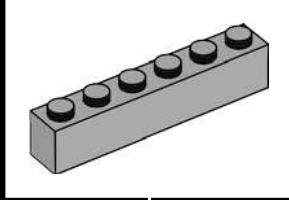
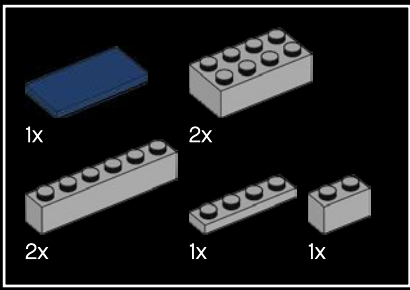

9

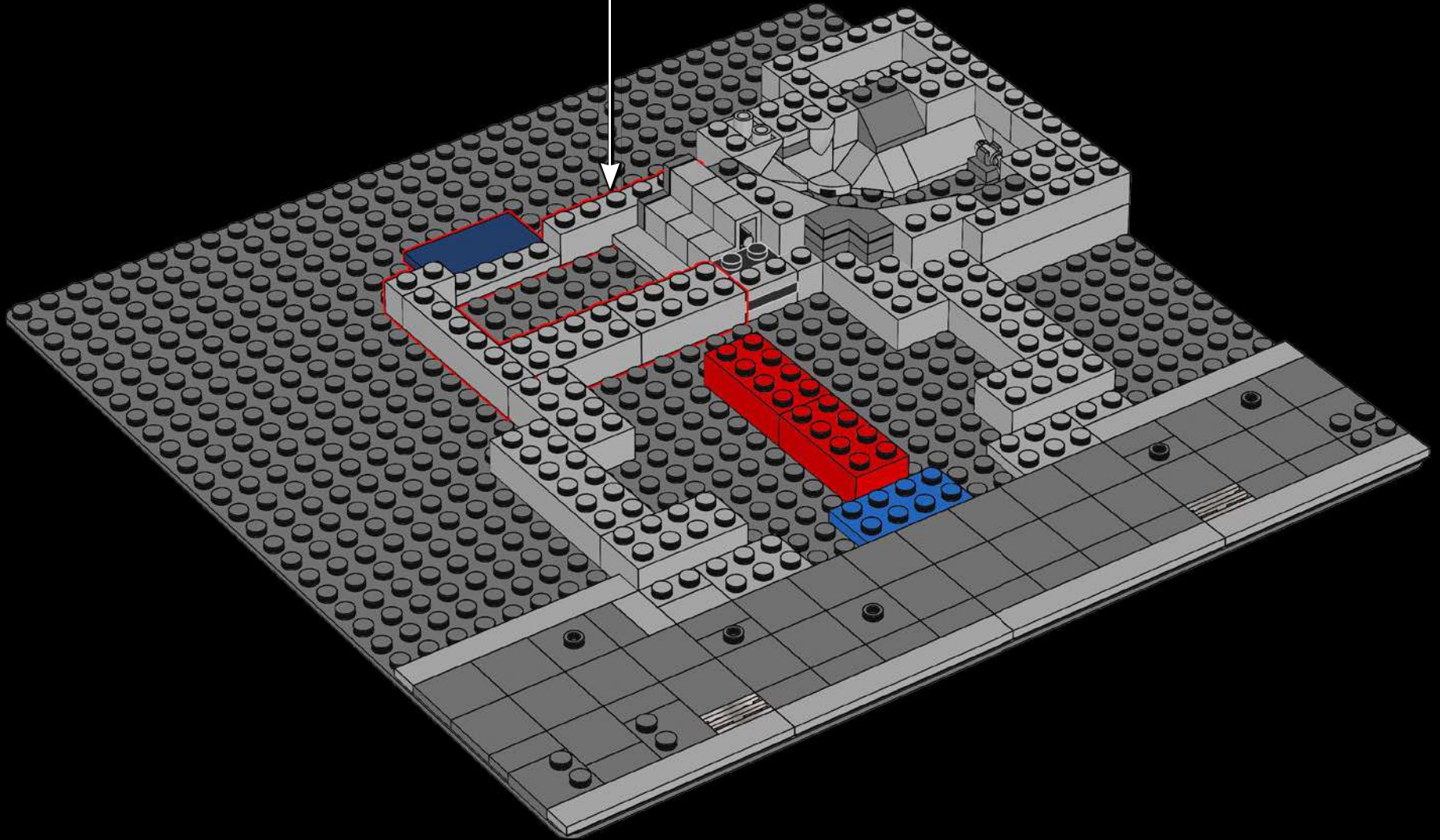



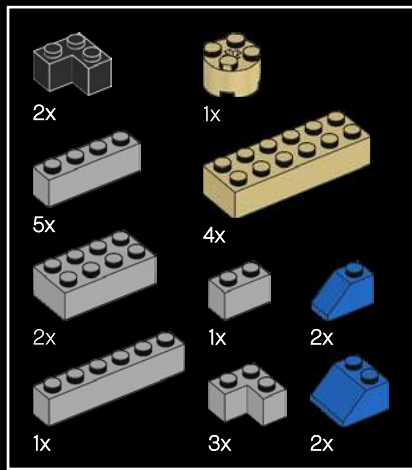

10

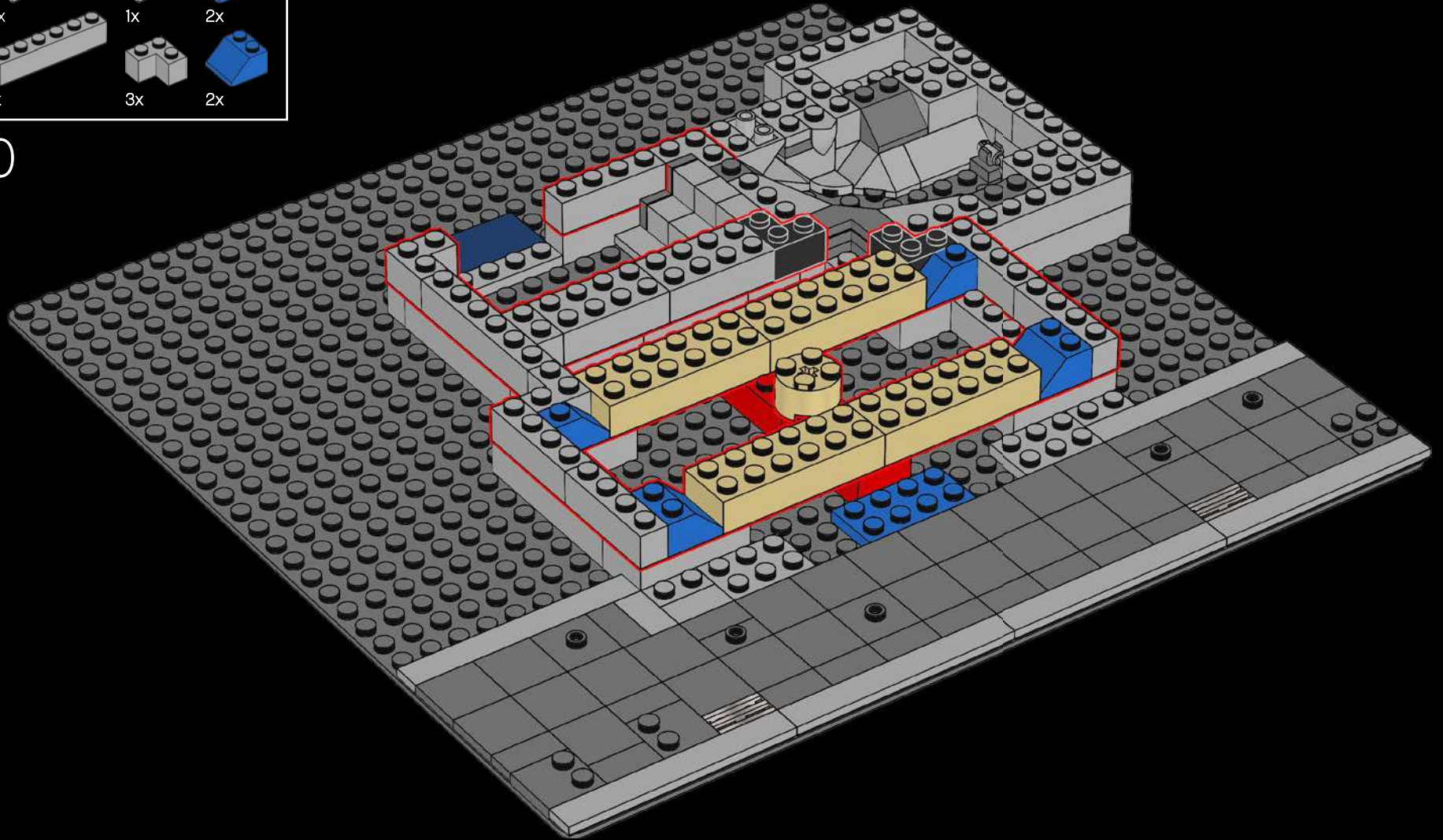



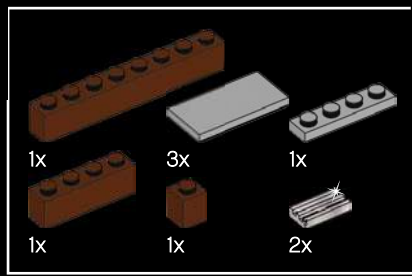

12

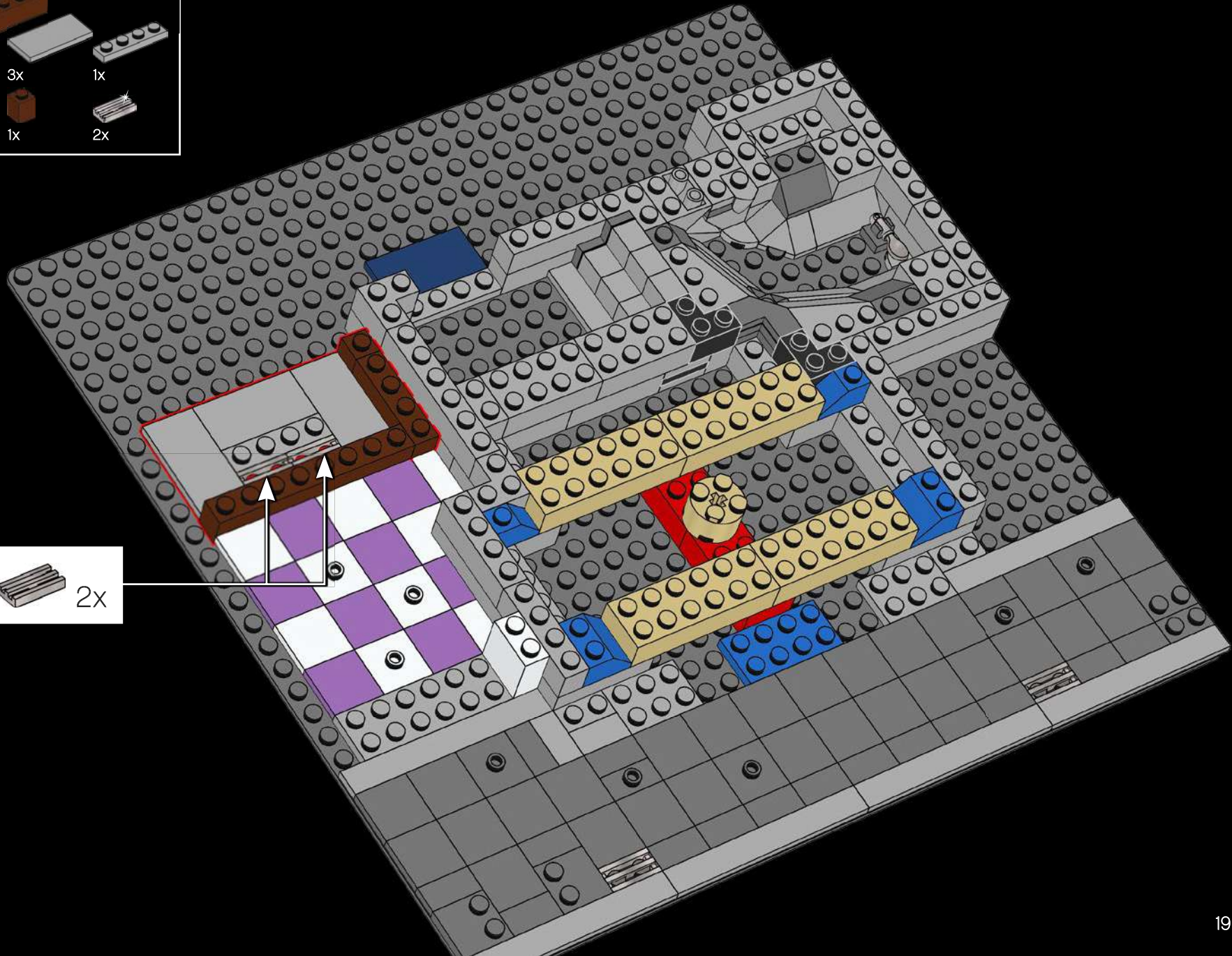

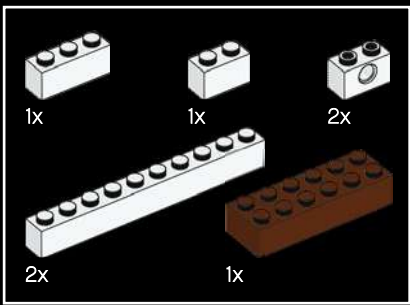

13

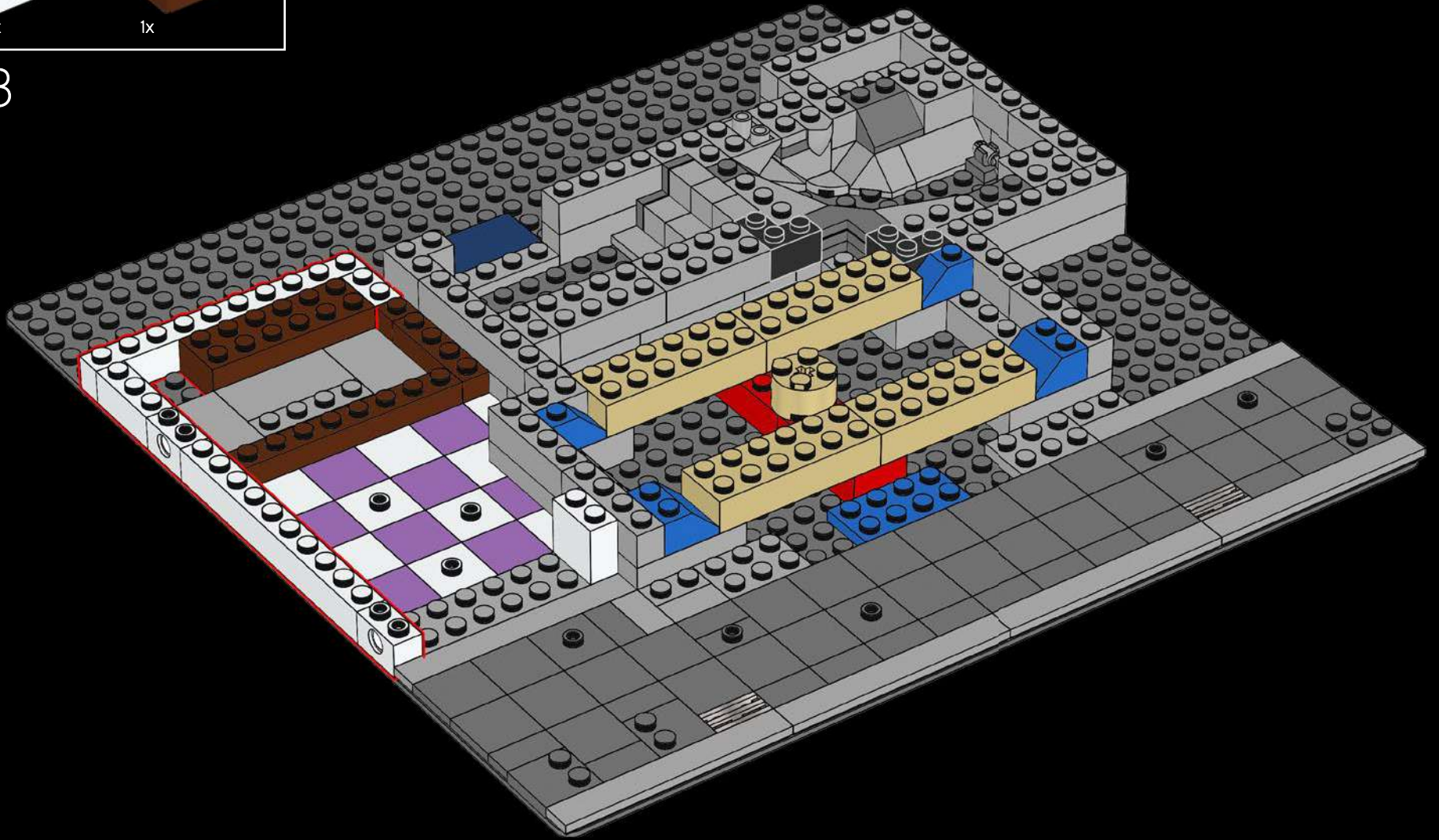

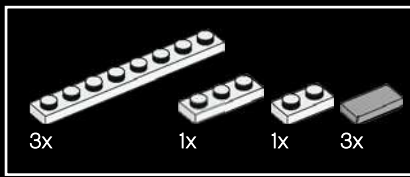

14

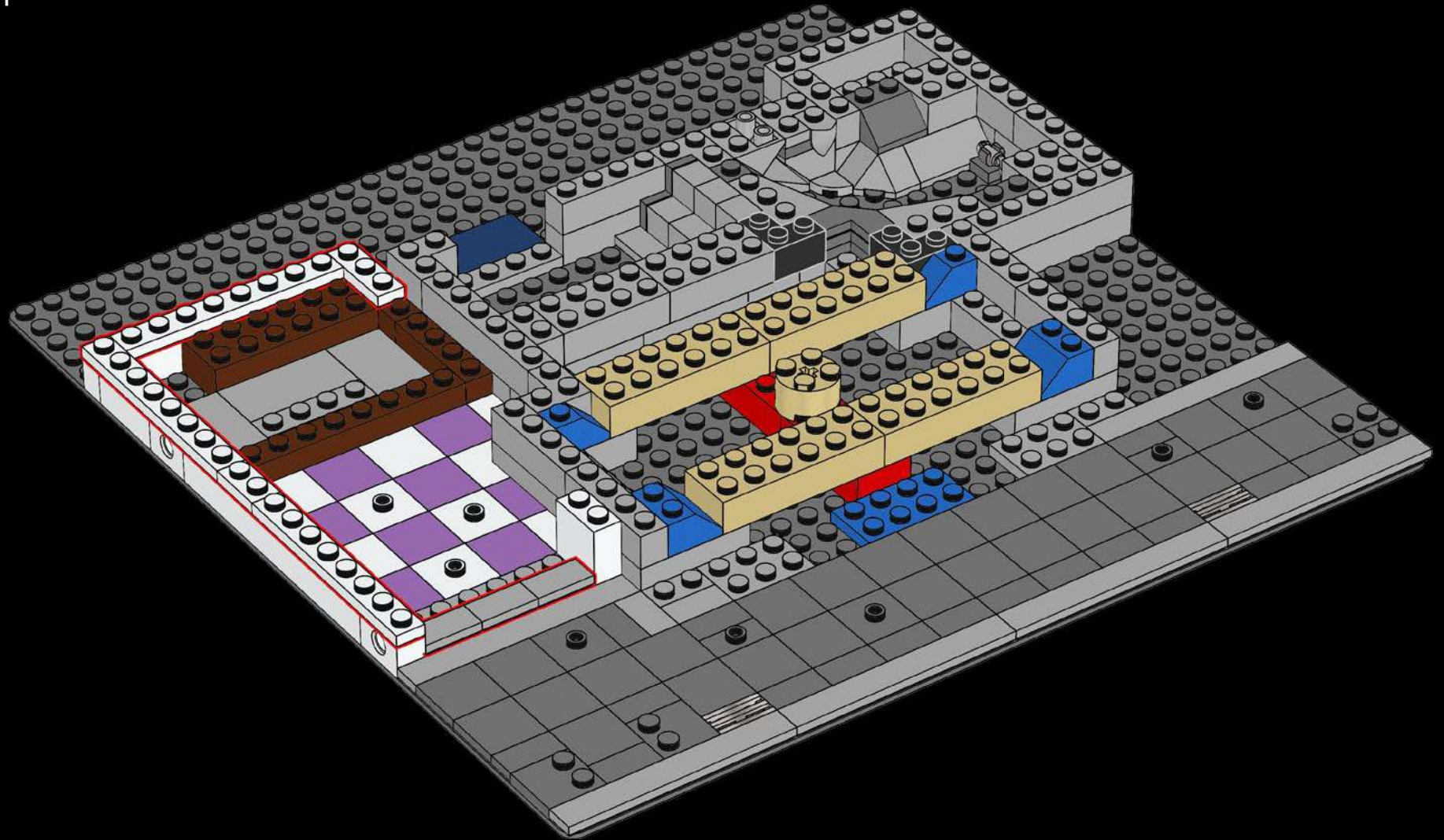



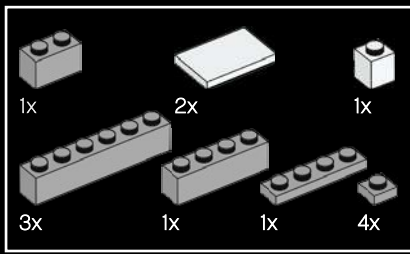

16

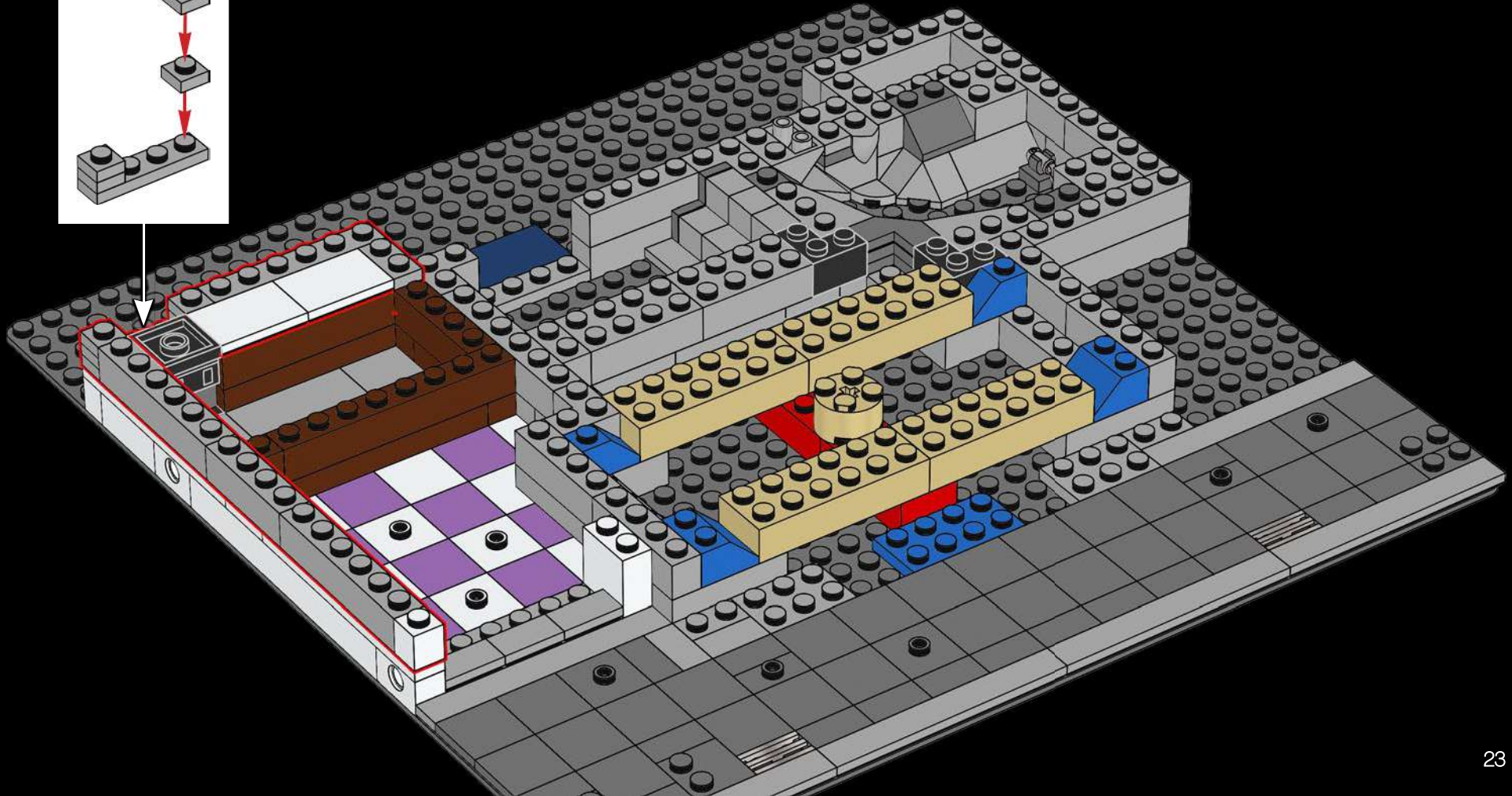
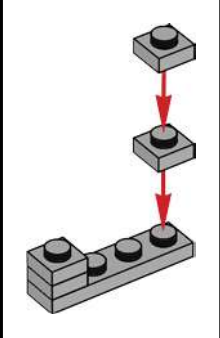

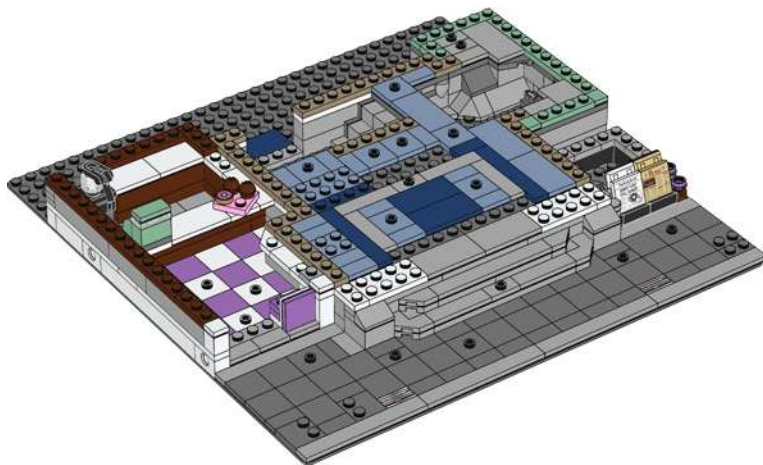





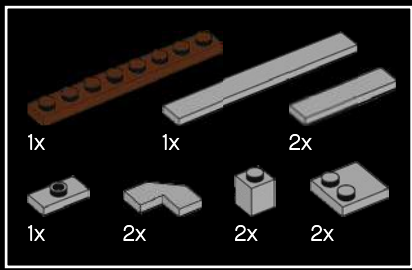

18

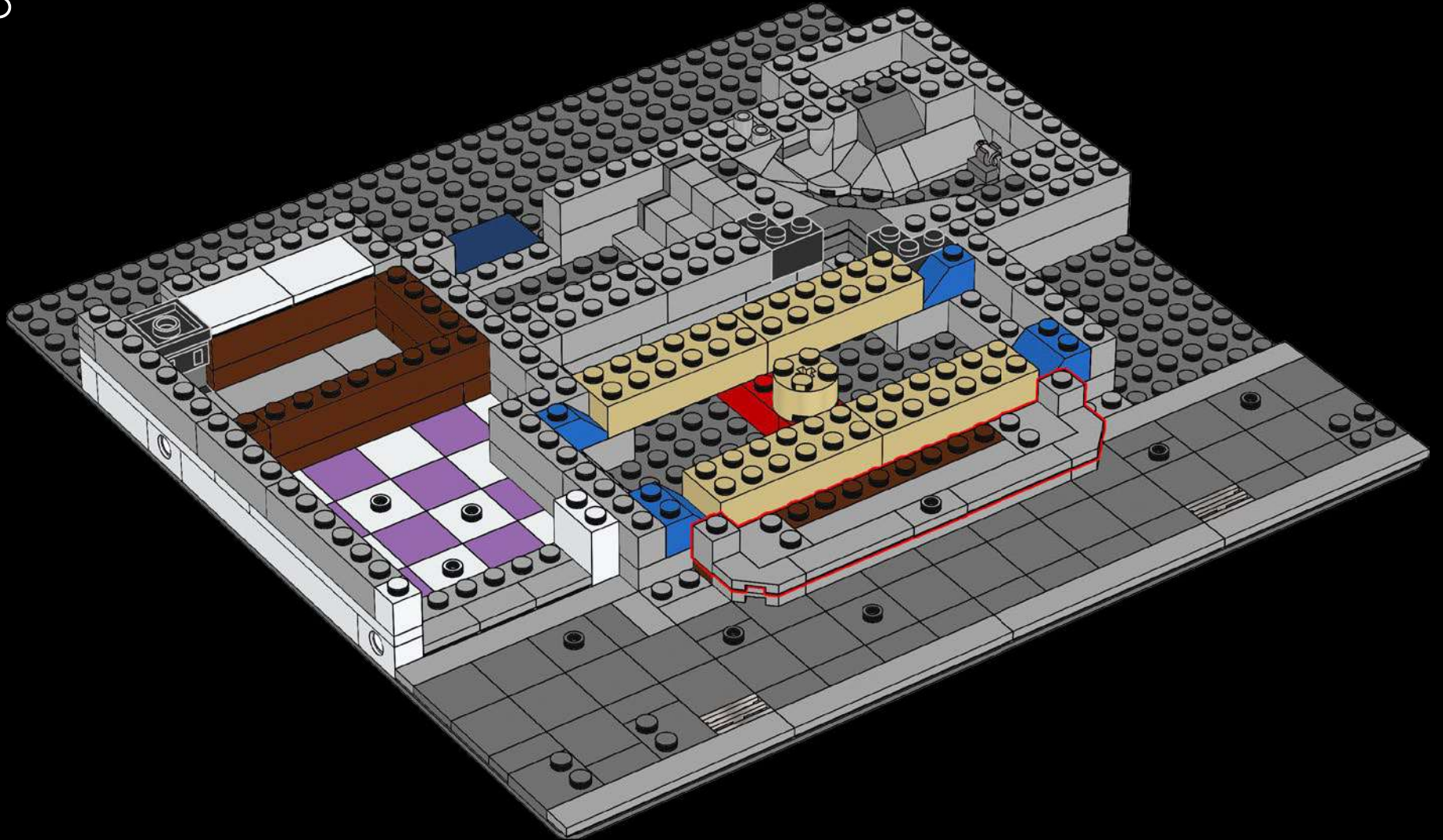

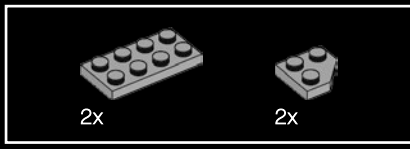

19

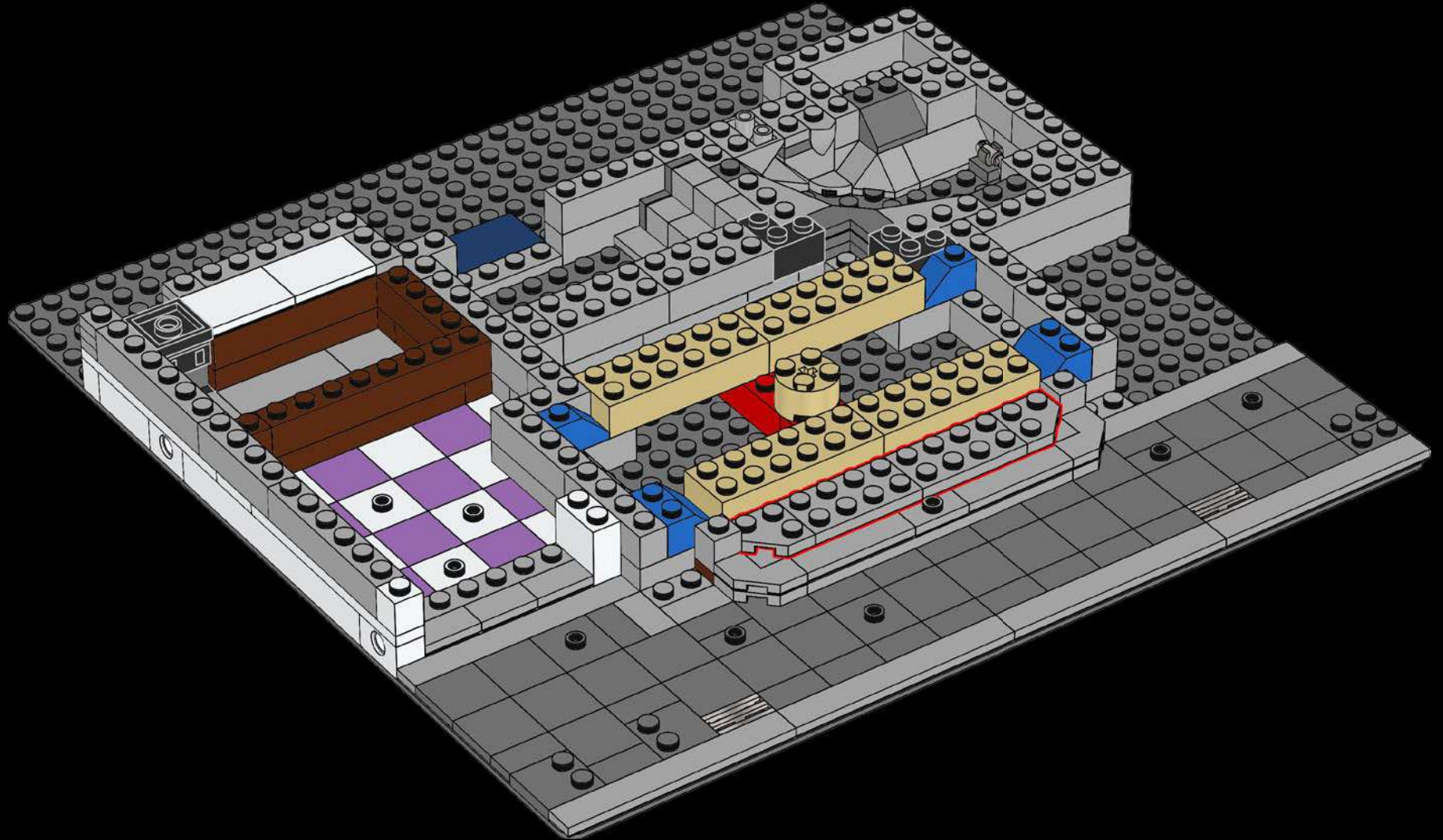

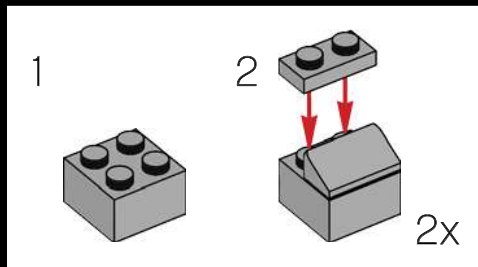
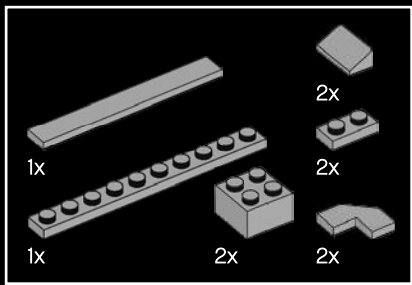

20

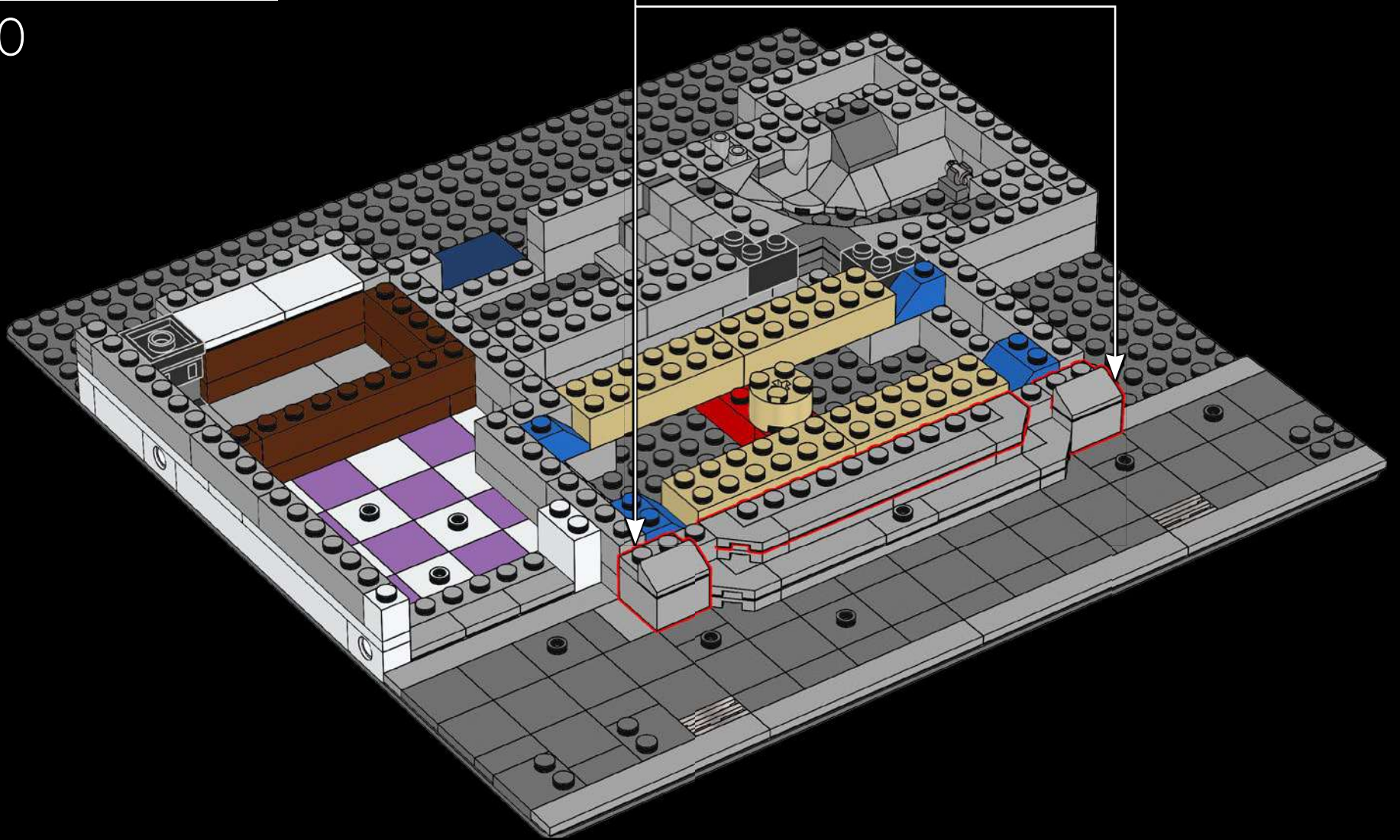

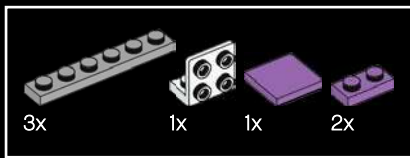

21

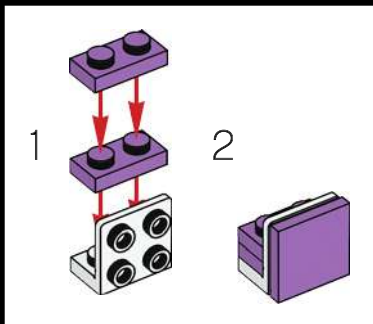
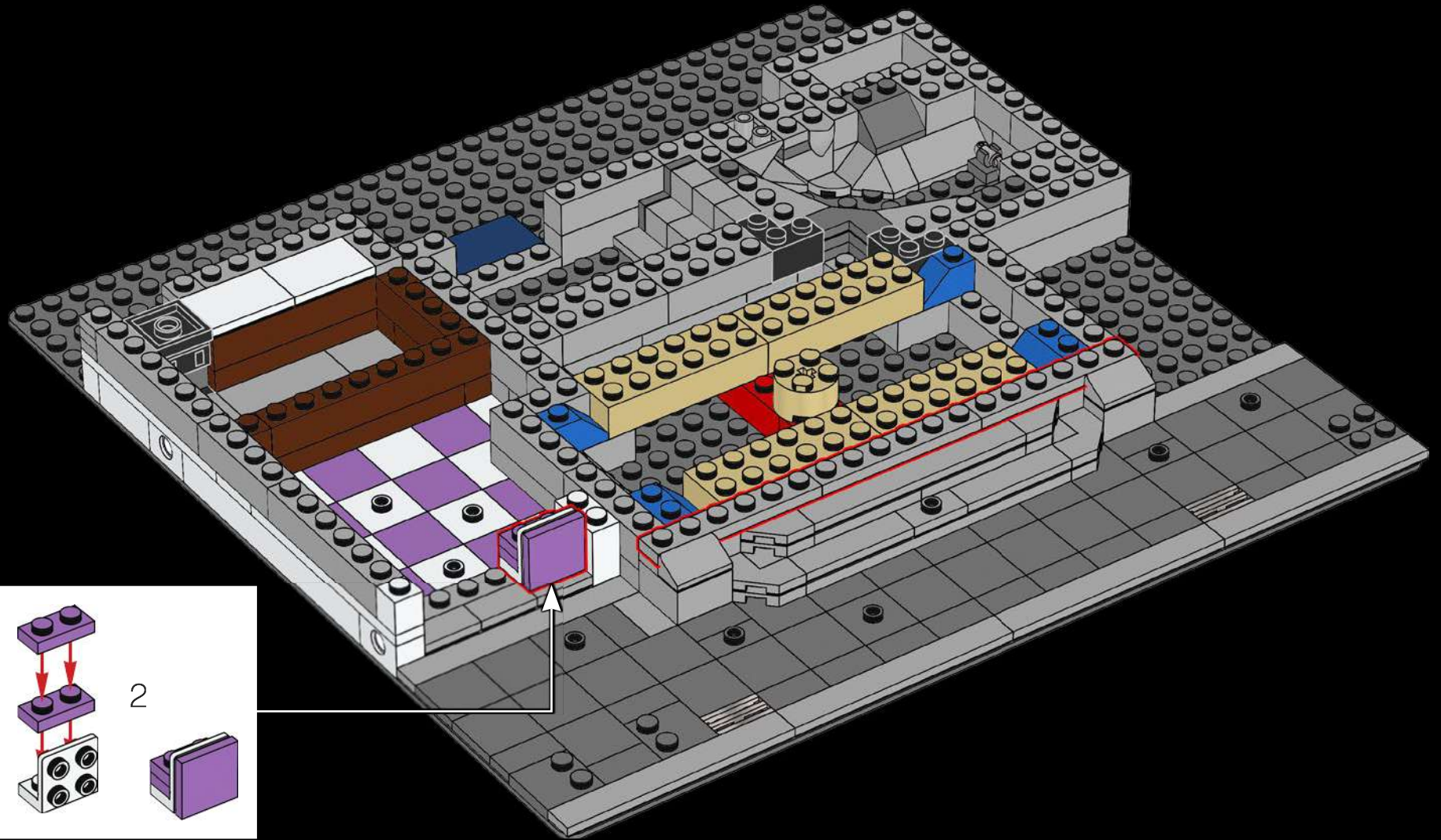





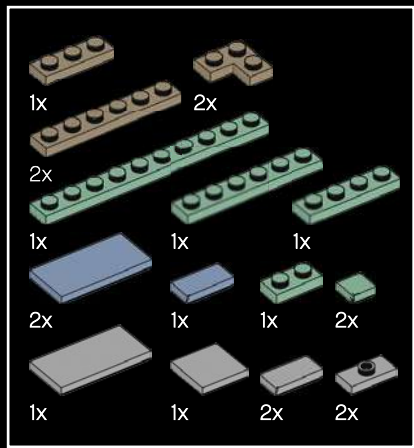

24

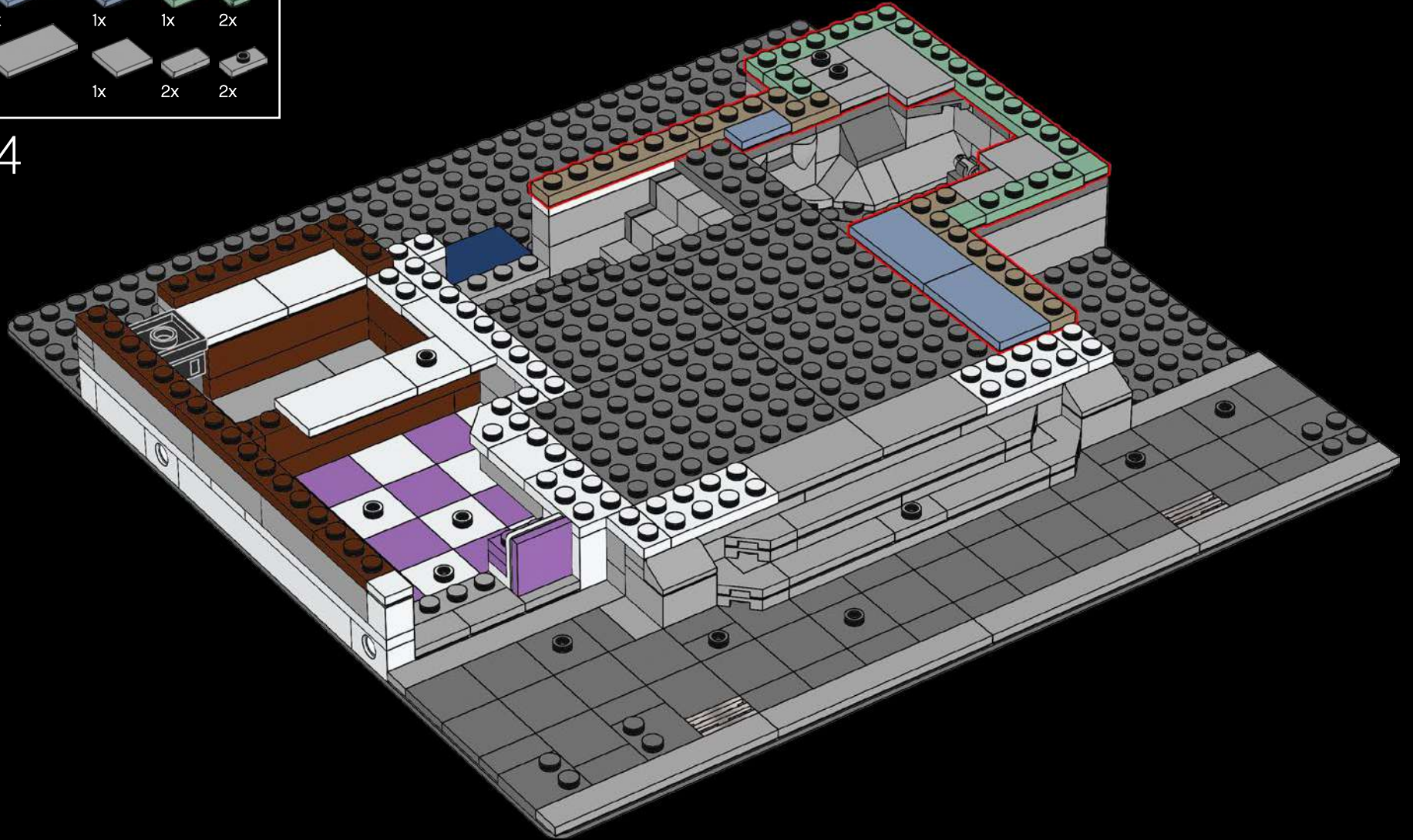



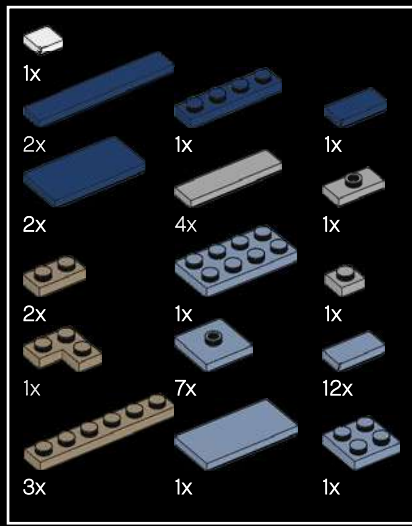

25

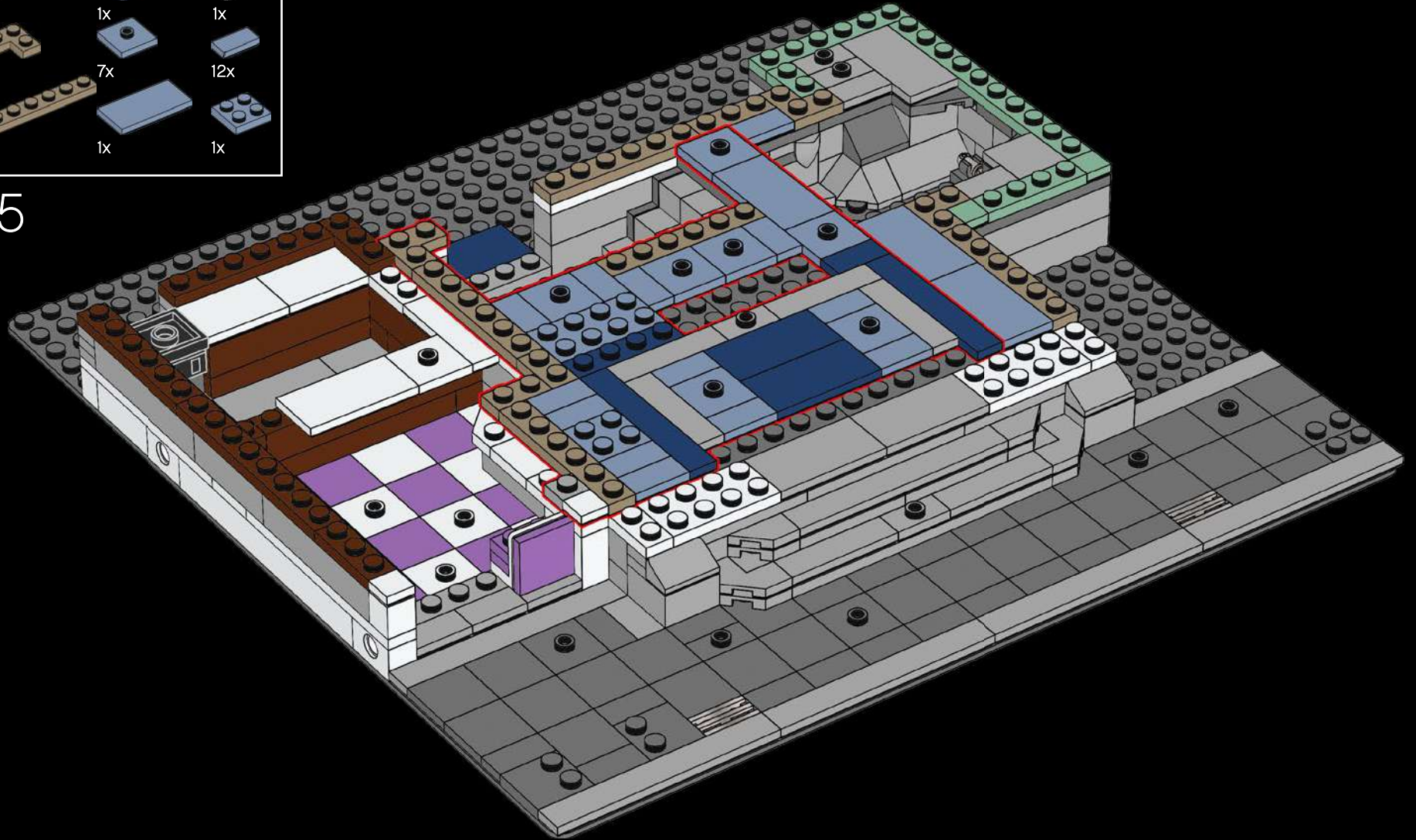

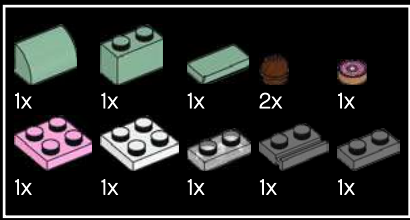

26

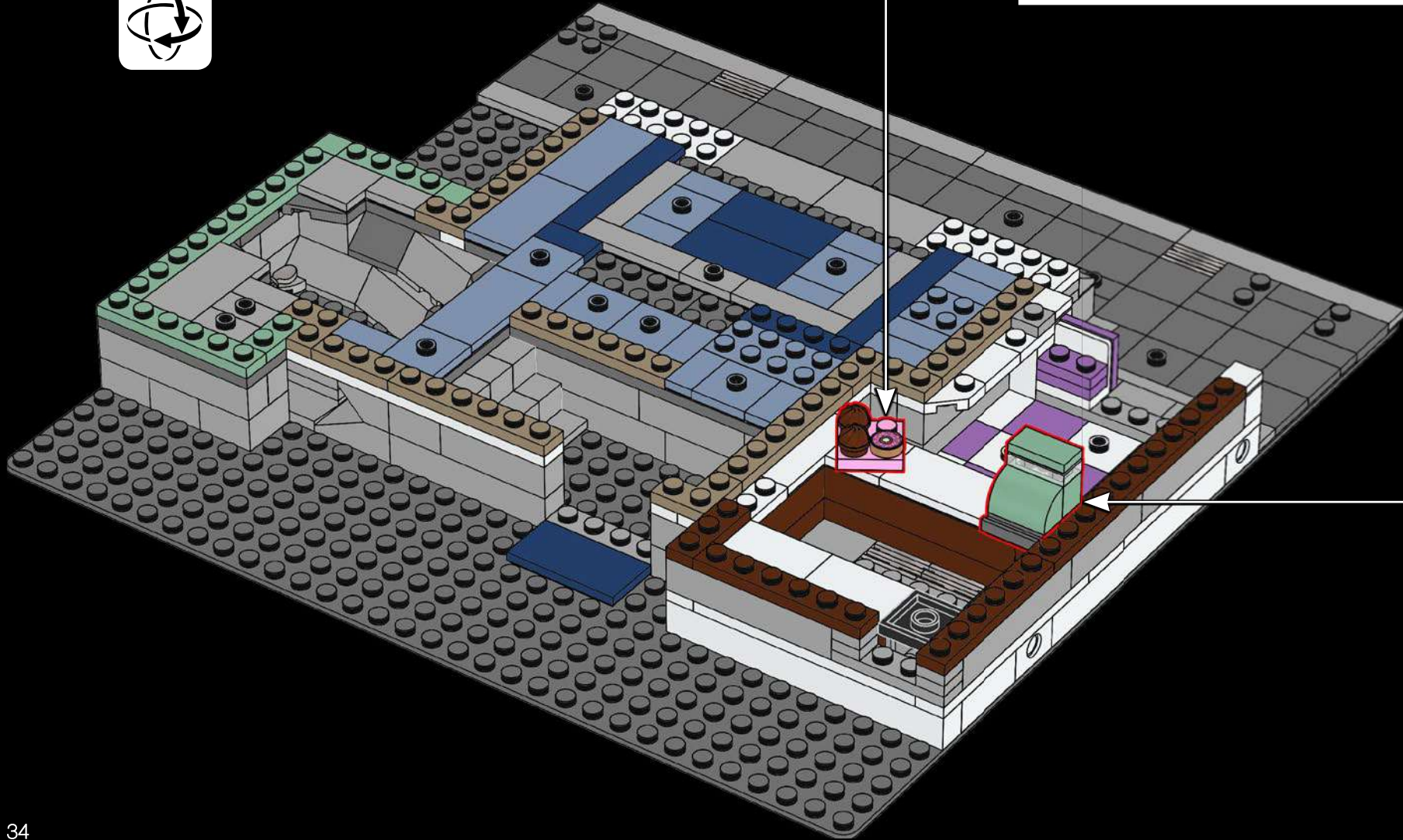
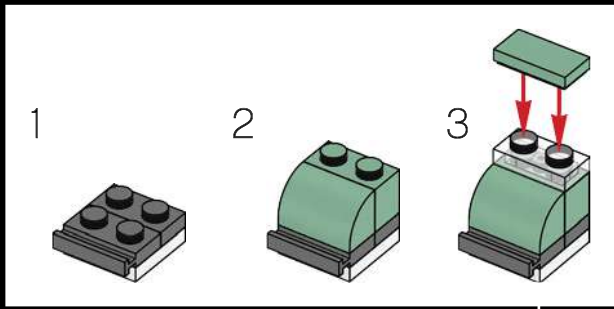
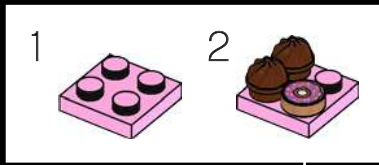

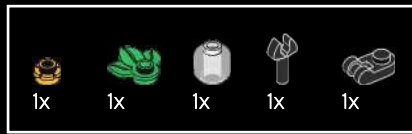

27

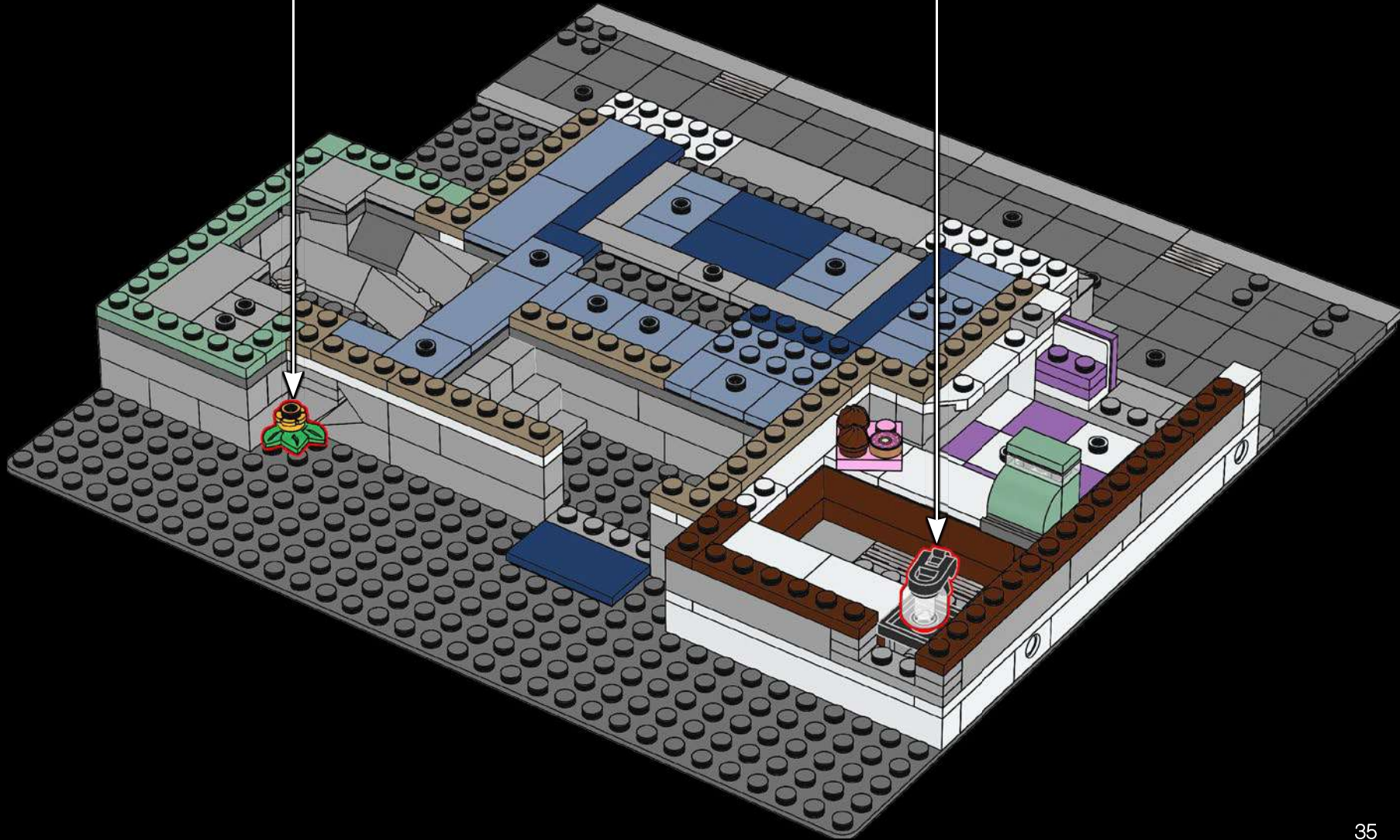
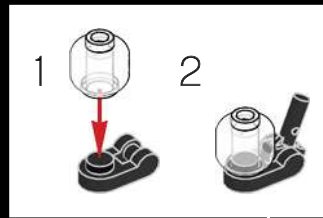
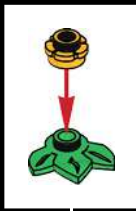

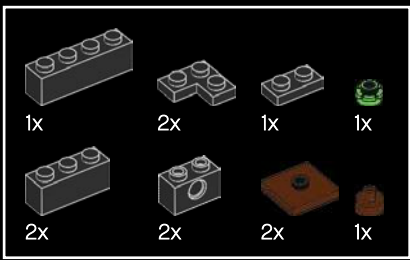



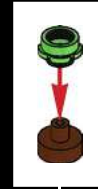

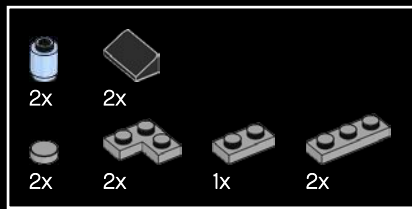

28

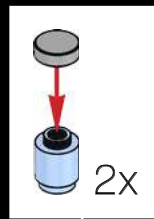



29



-   
2x
-   
2x
-   
1x
-   
2x
-   
1x

30

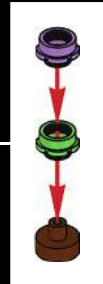
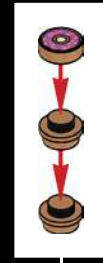
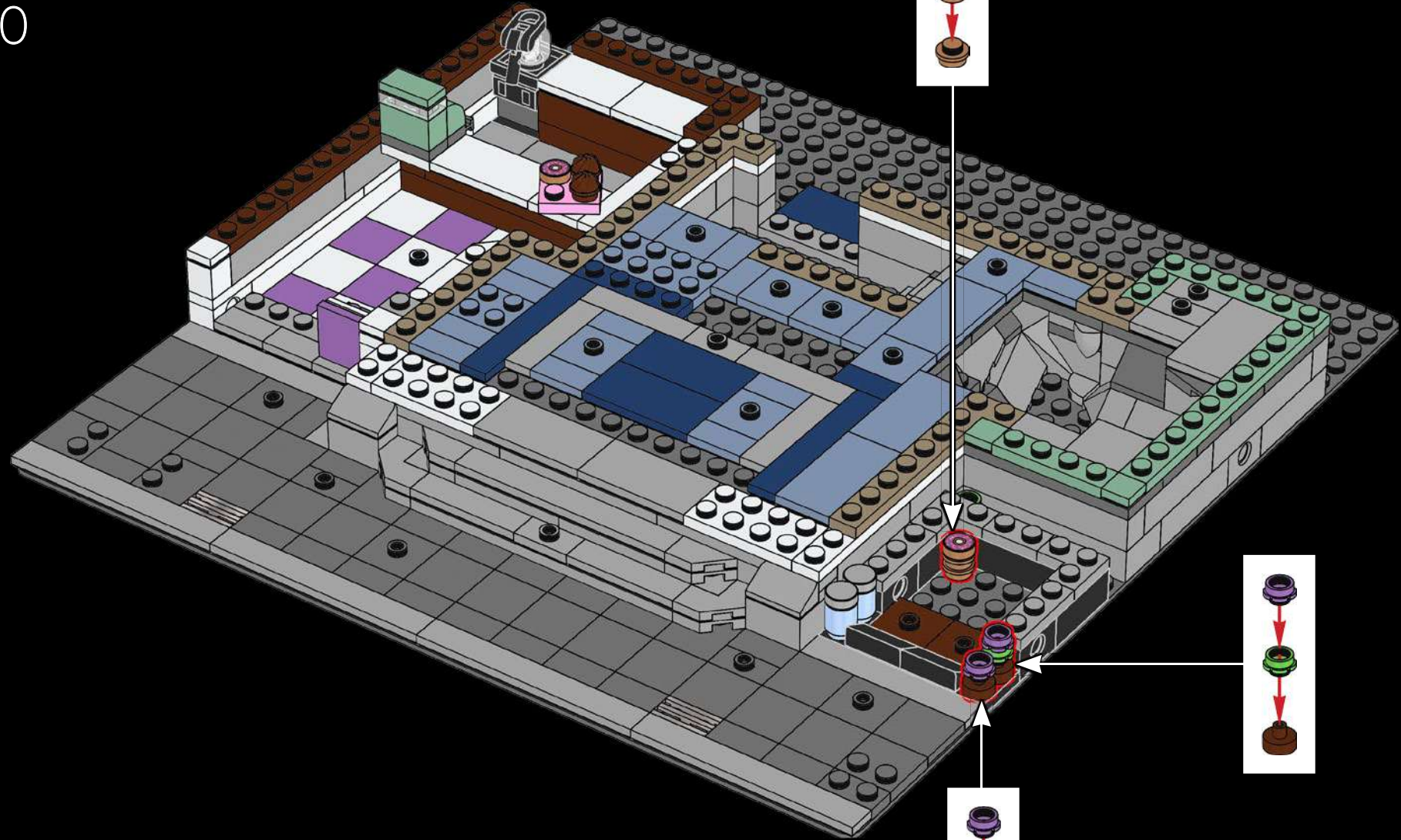

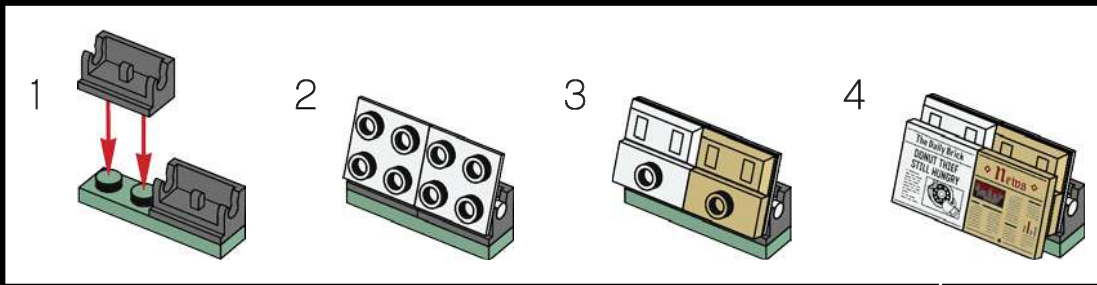
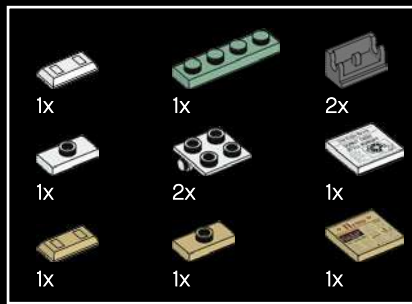

31



Our good-natured shop owner runs the delicious doughnut shop.

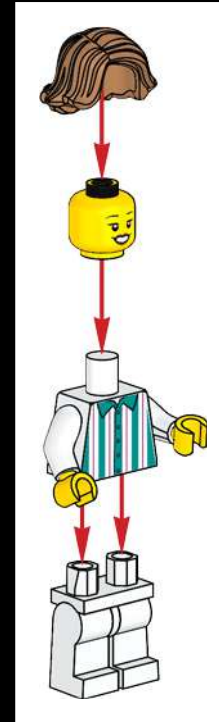
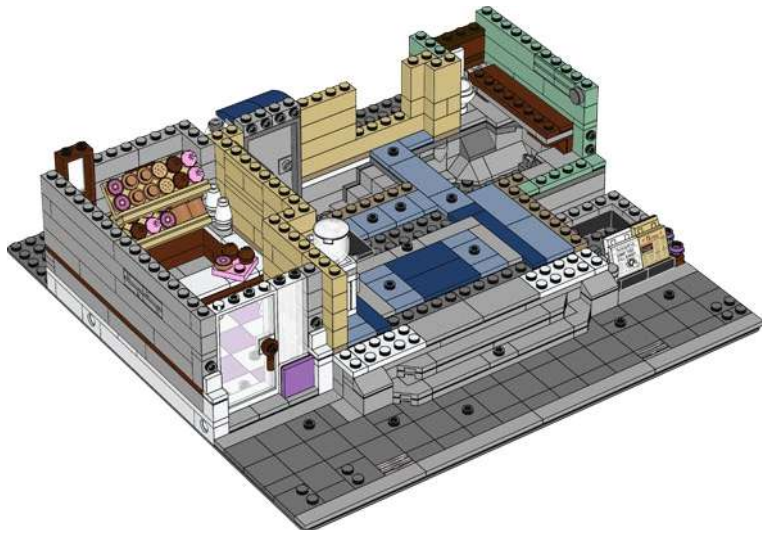





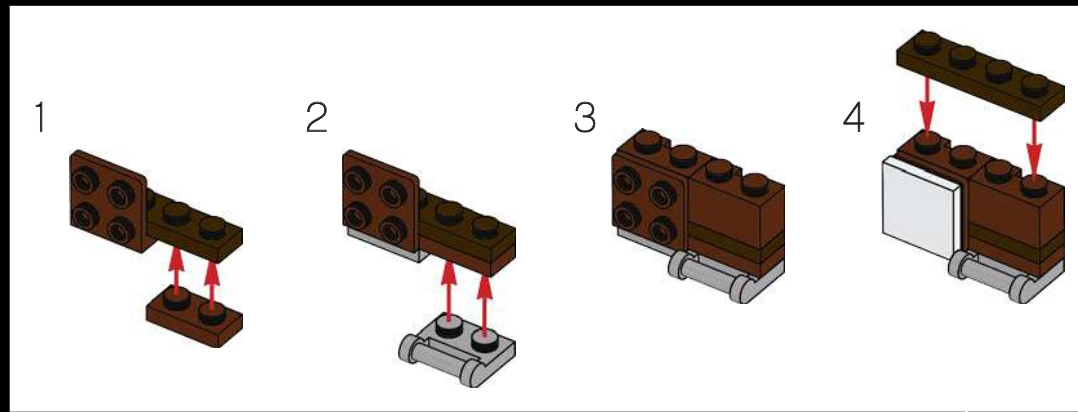
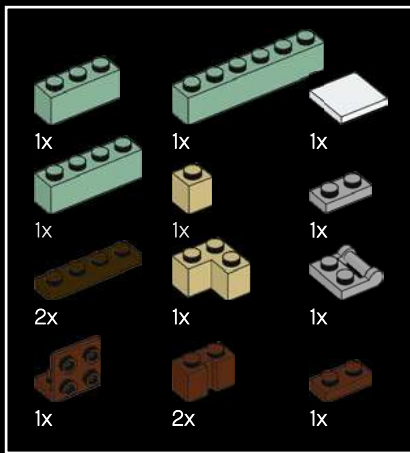

33

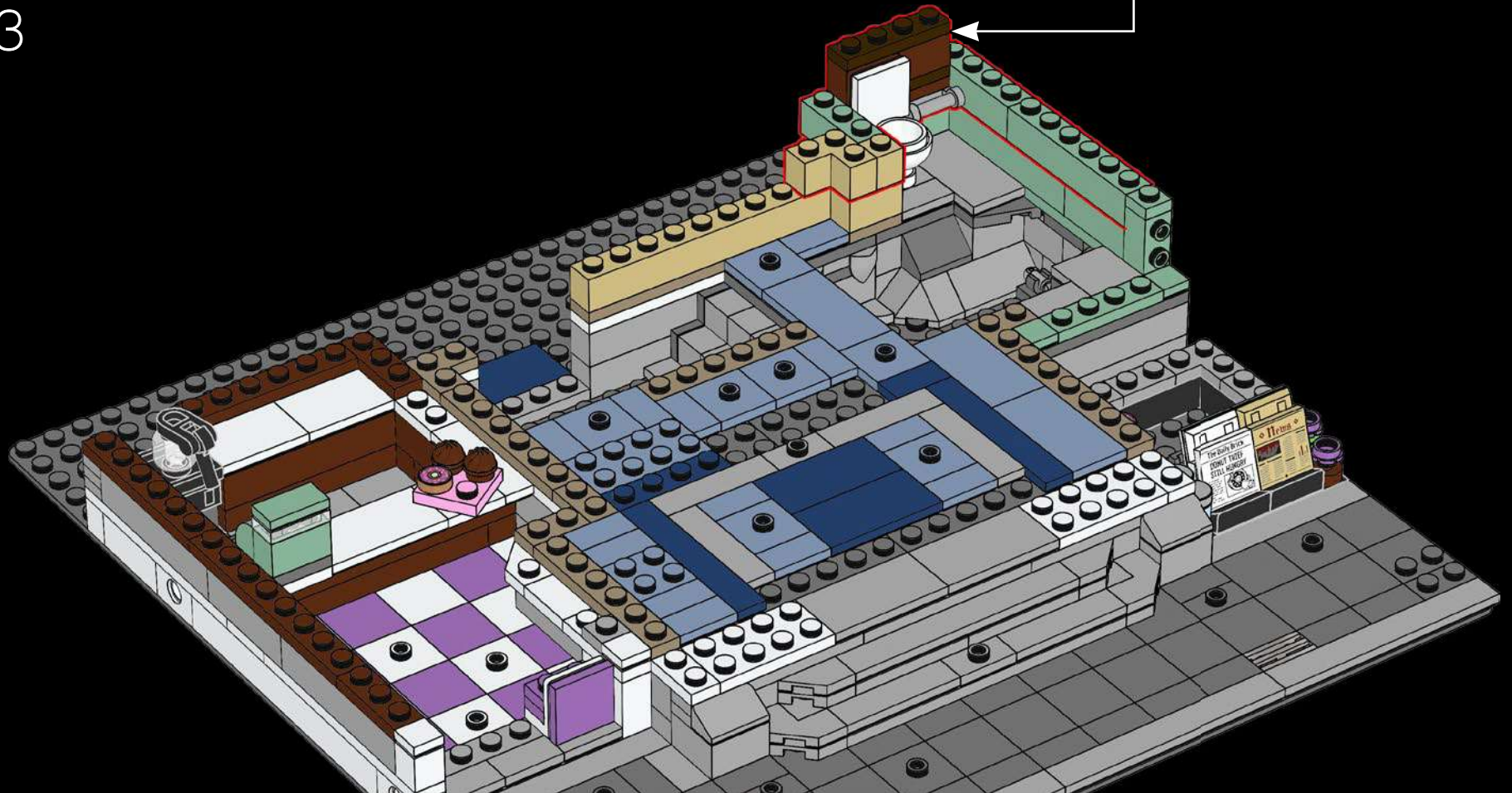

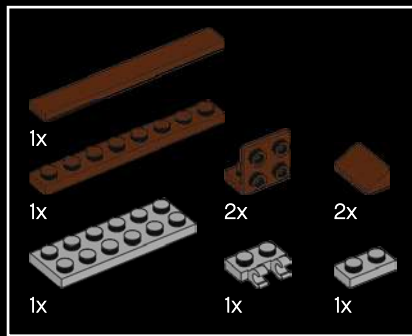

34

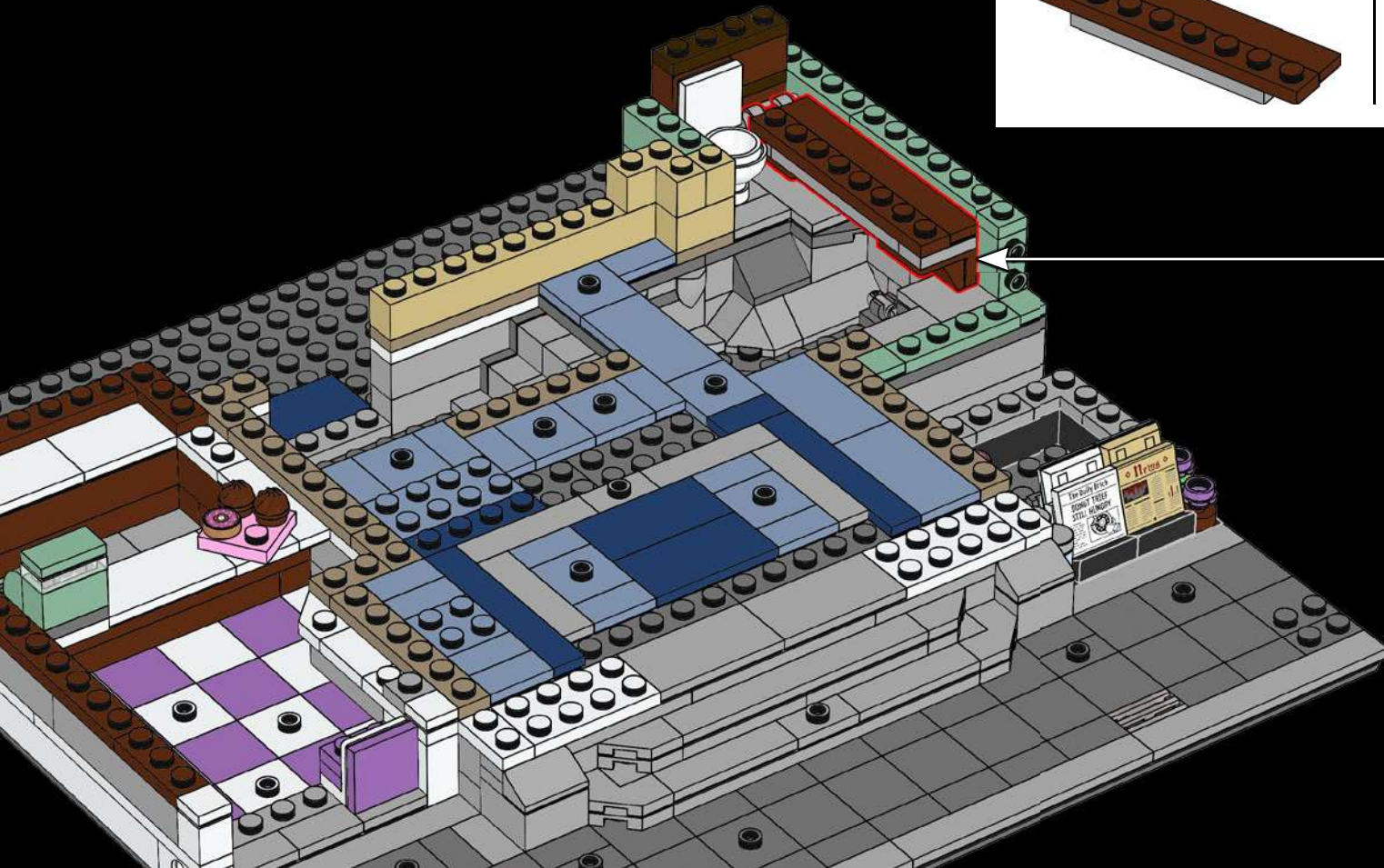
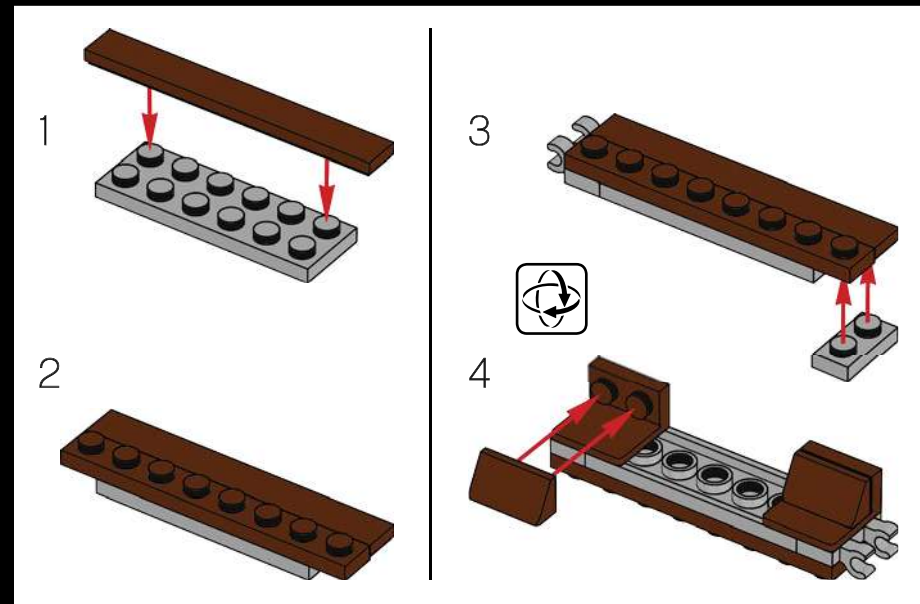

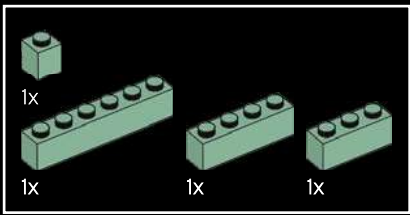

35



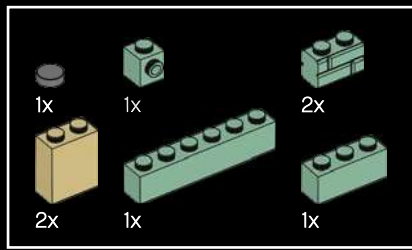

36

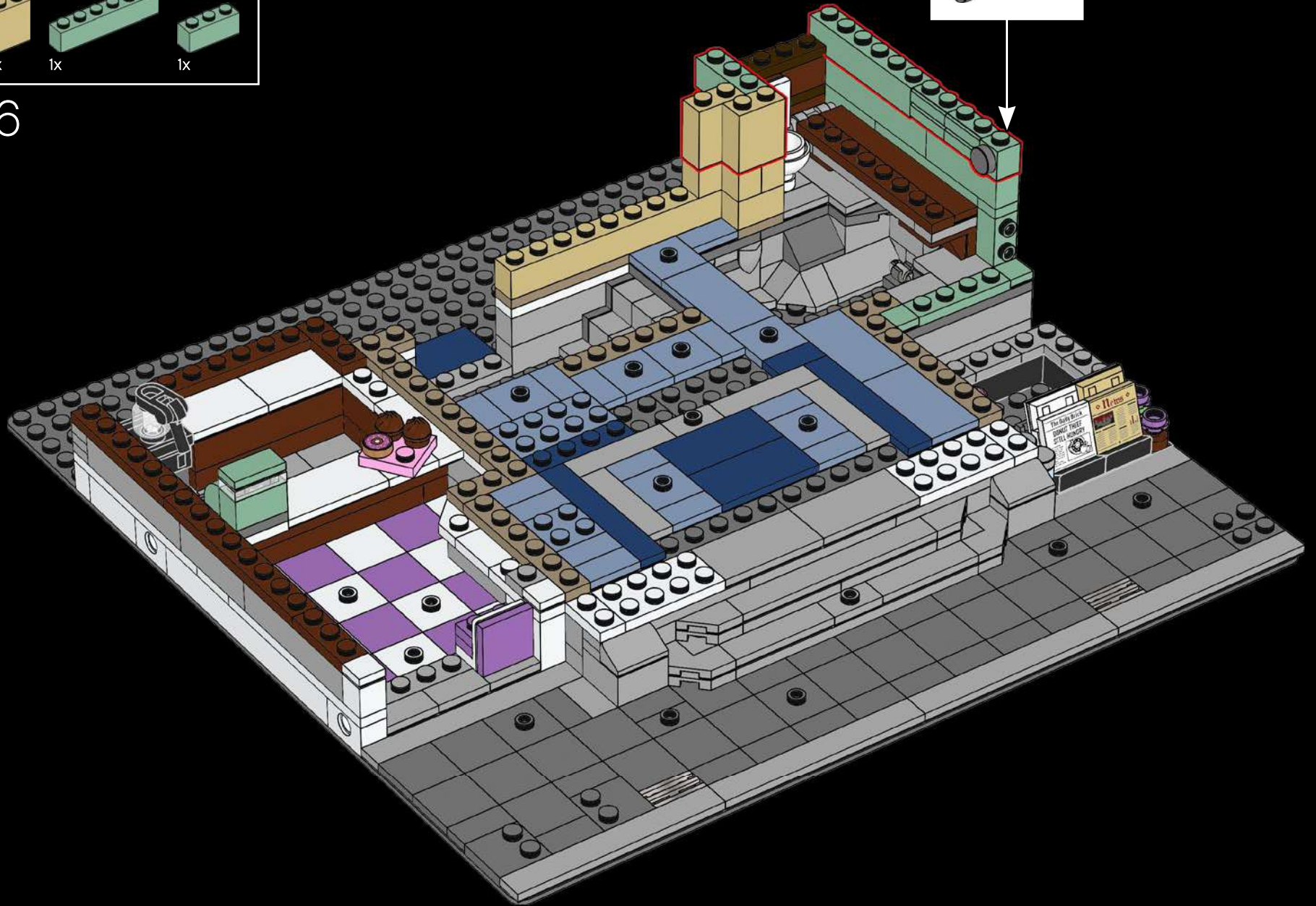
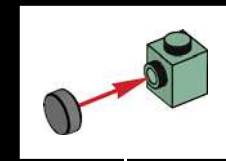



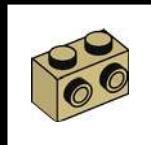
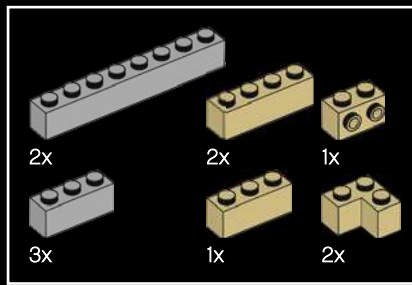

38

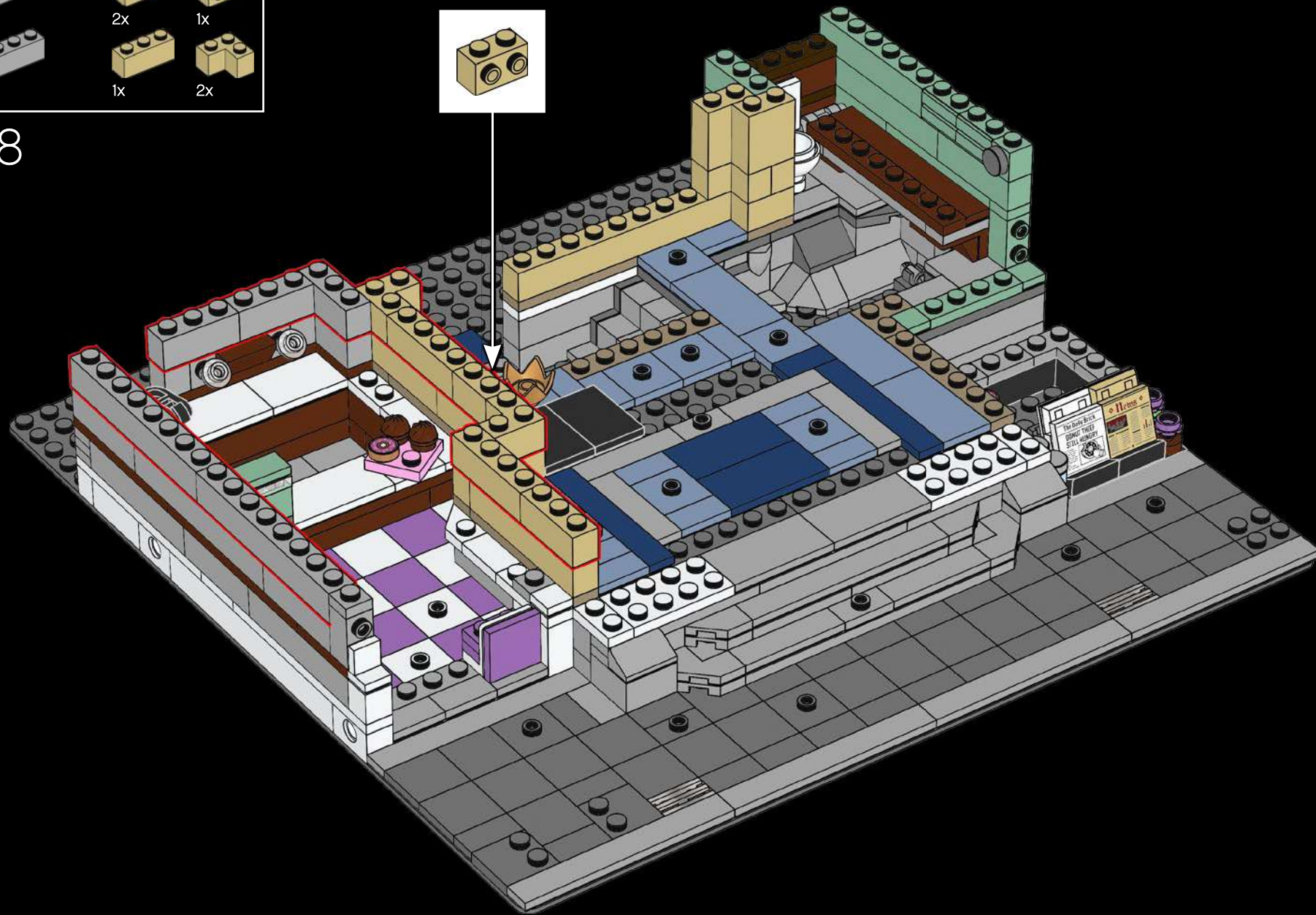





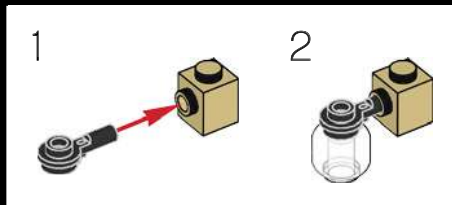
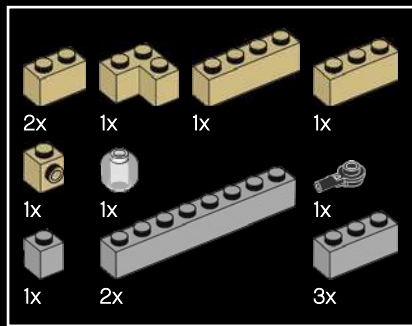

40

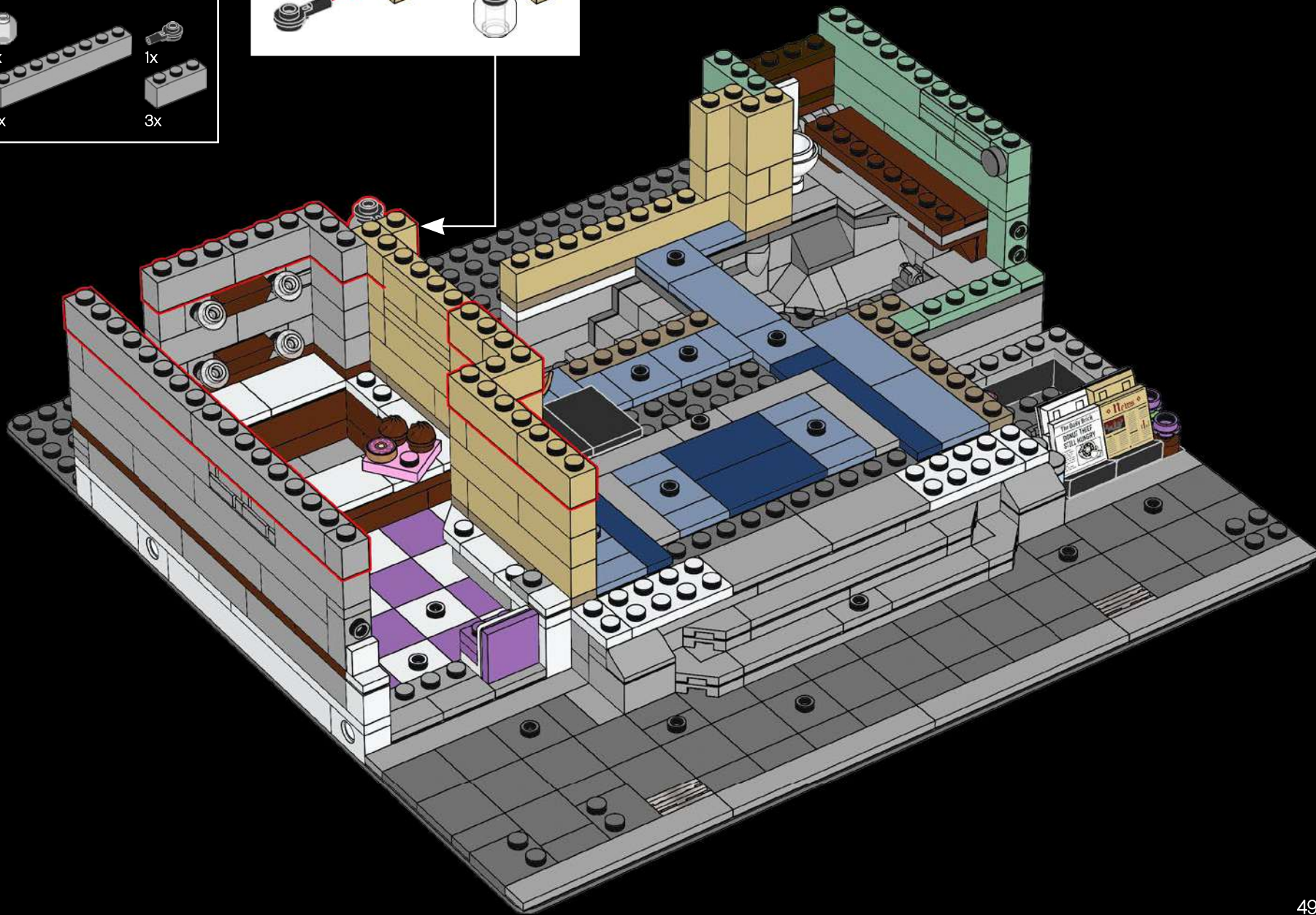

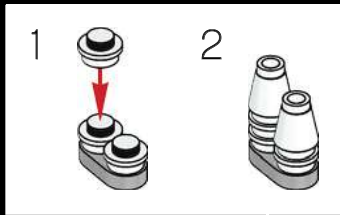
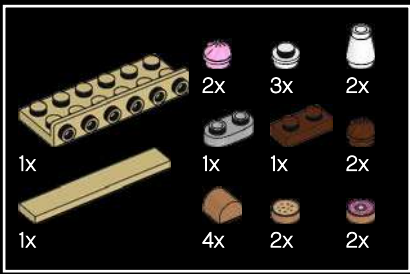

41

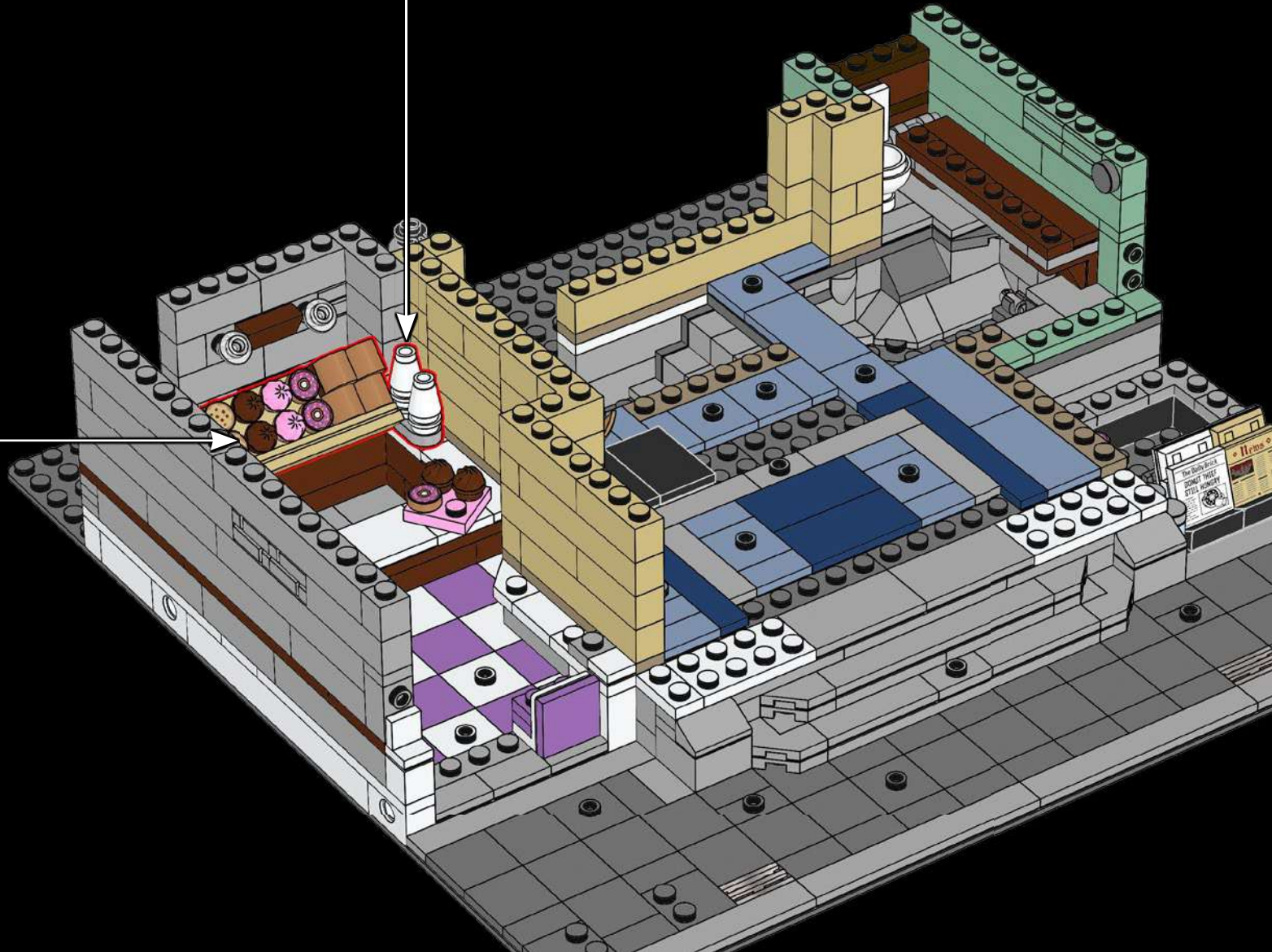
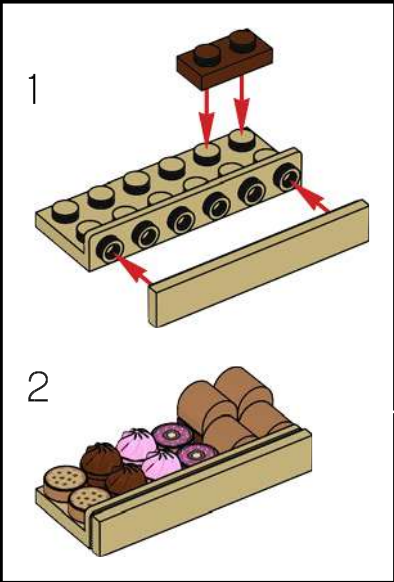

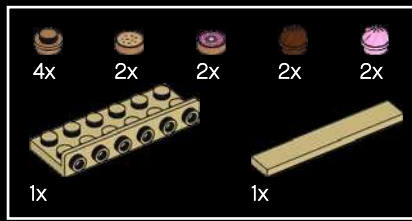

42

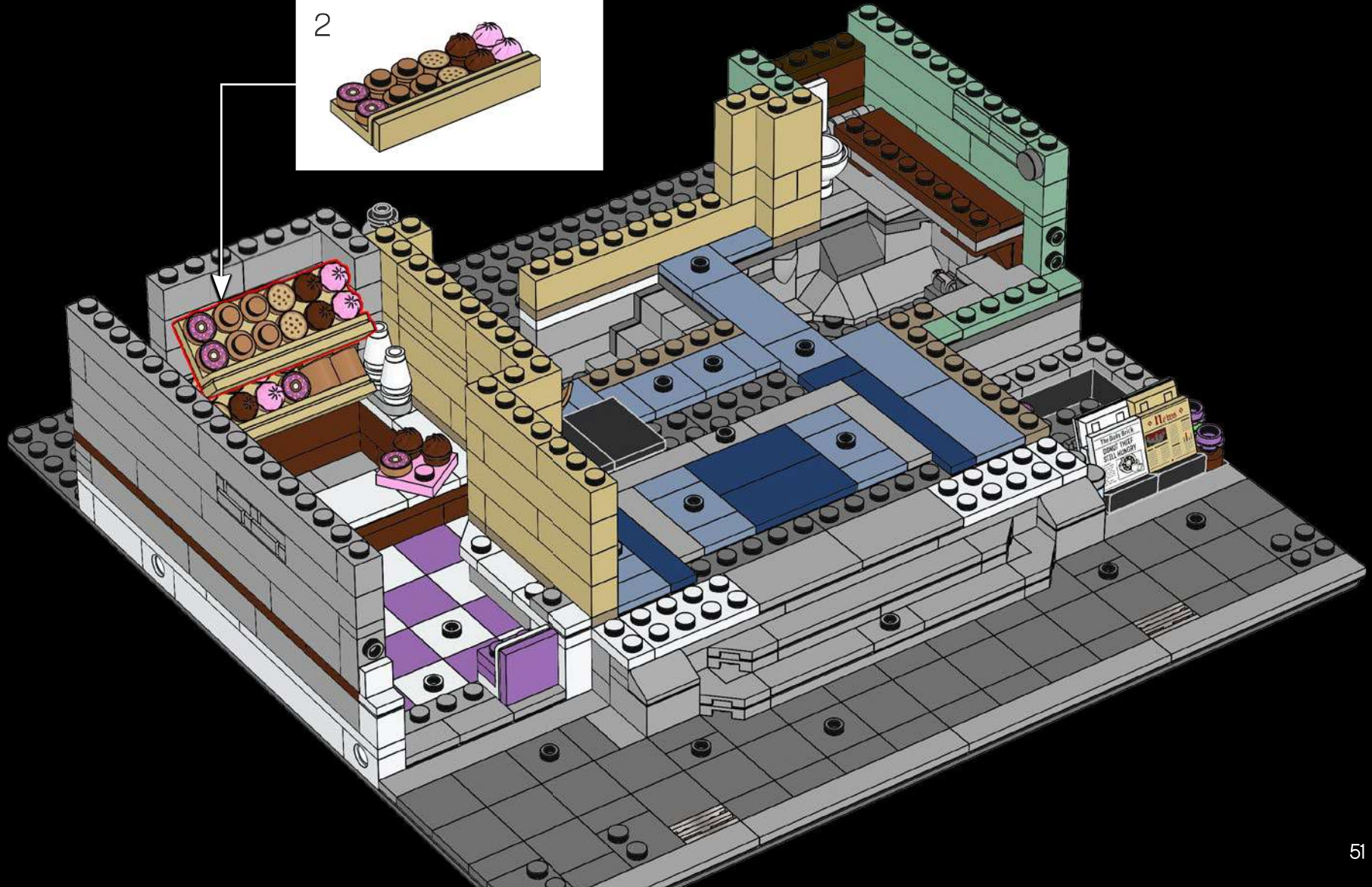
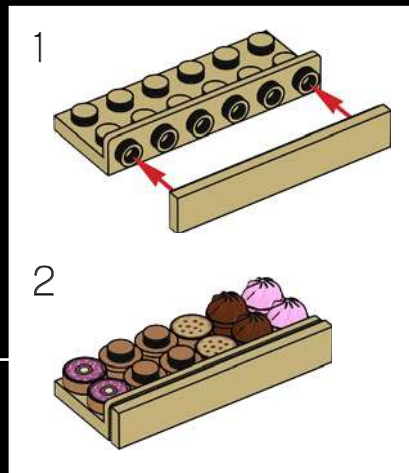

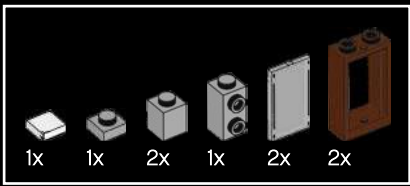

43

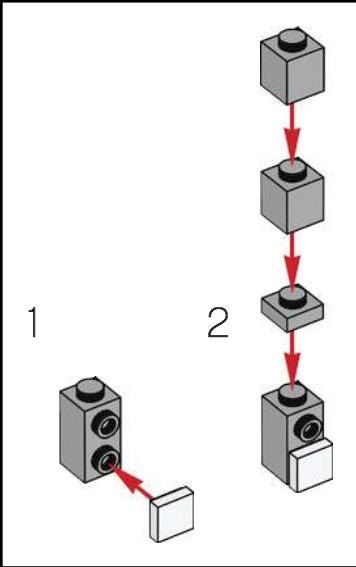
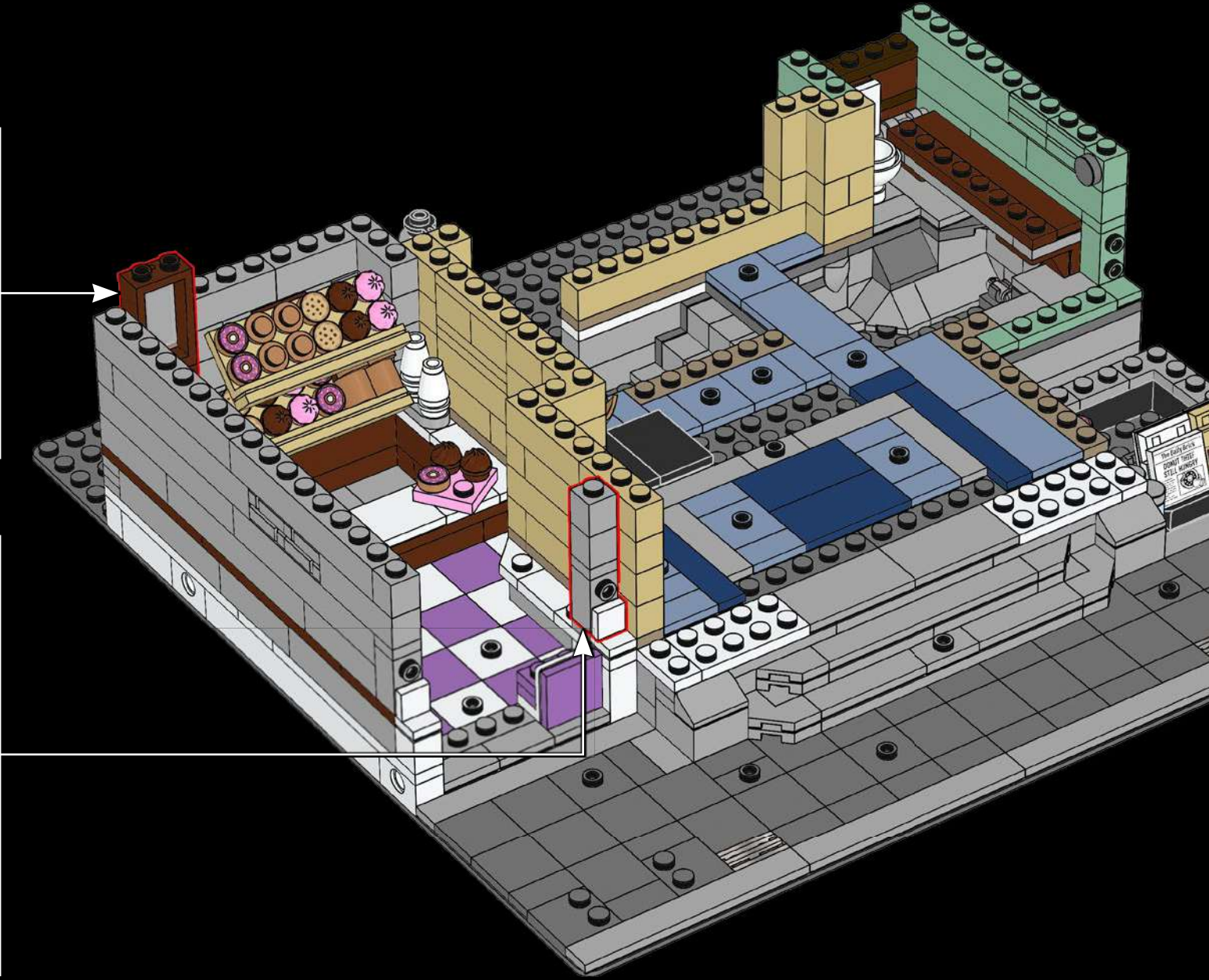
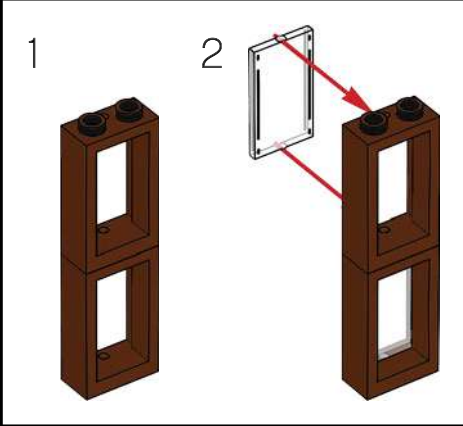

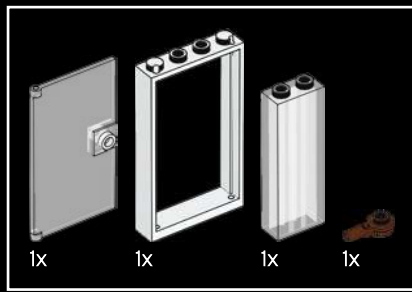

44

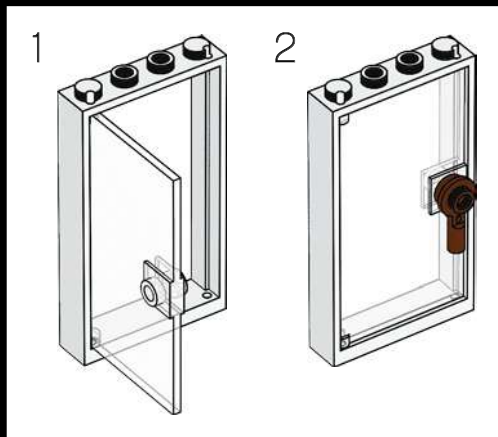
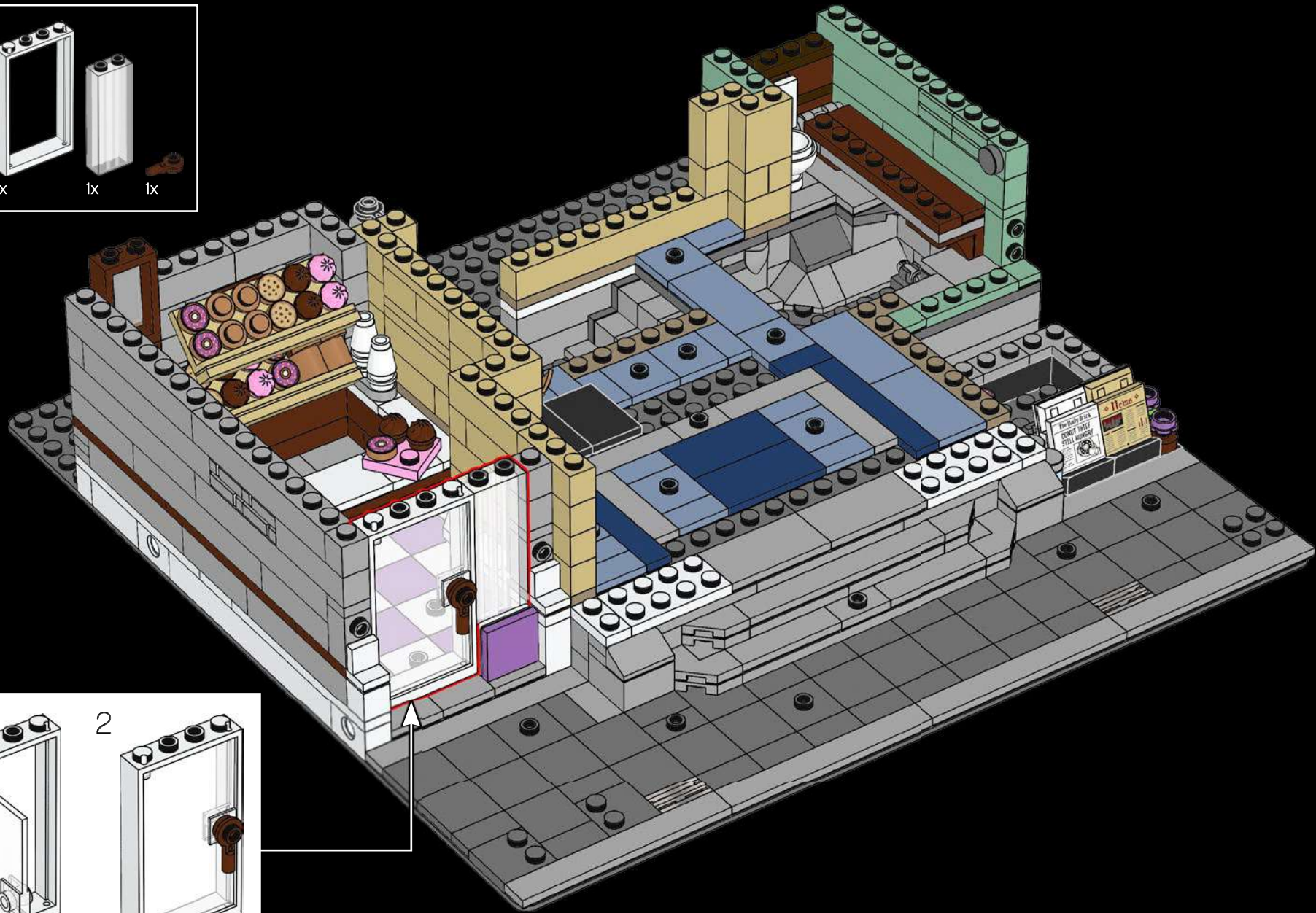

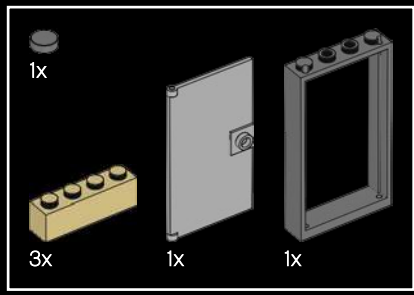

45

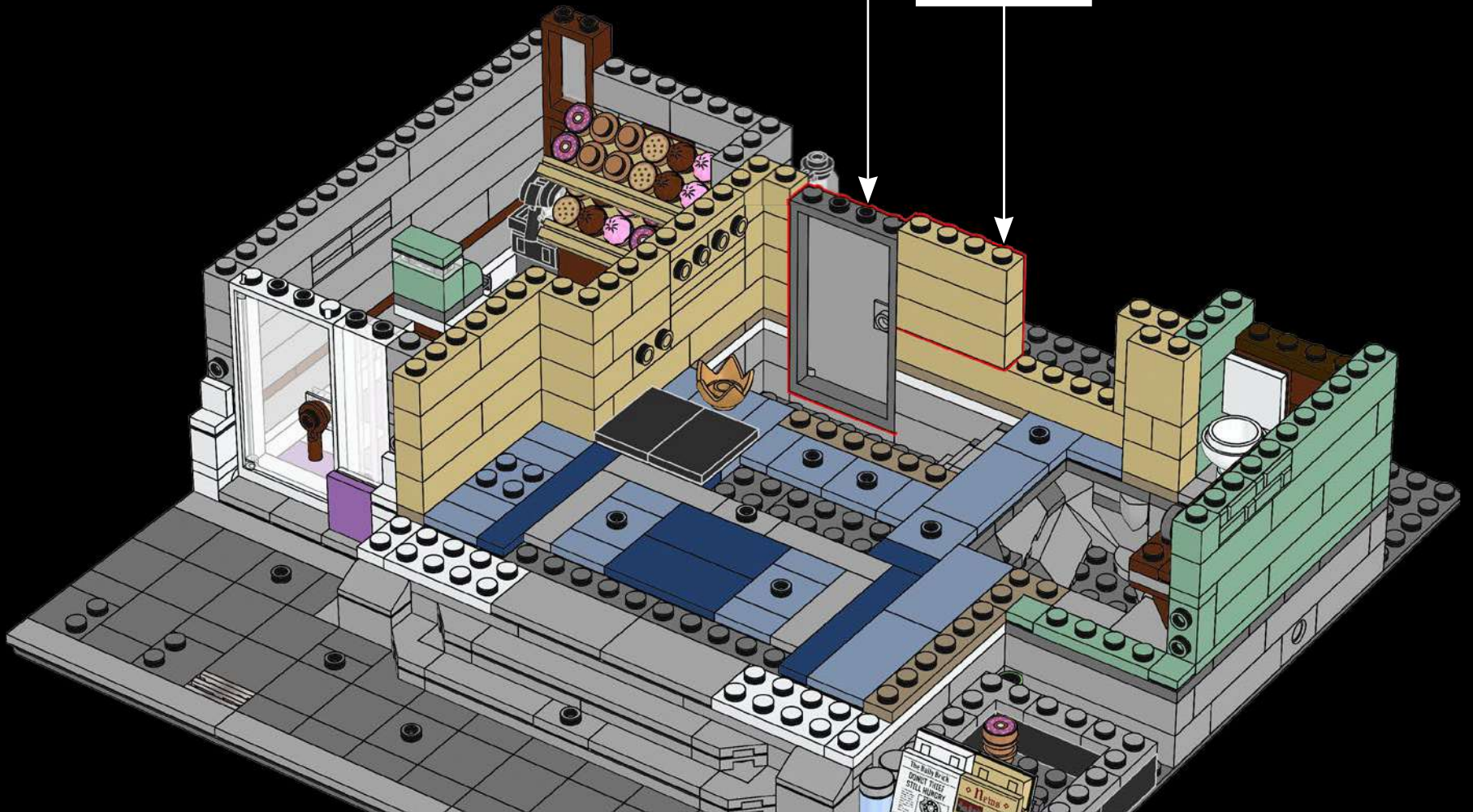
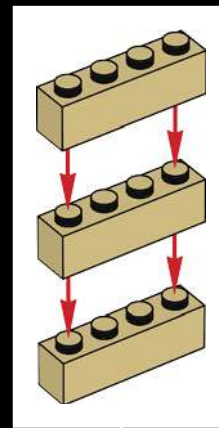
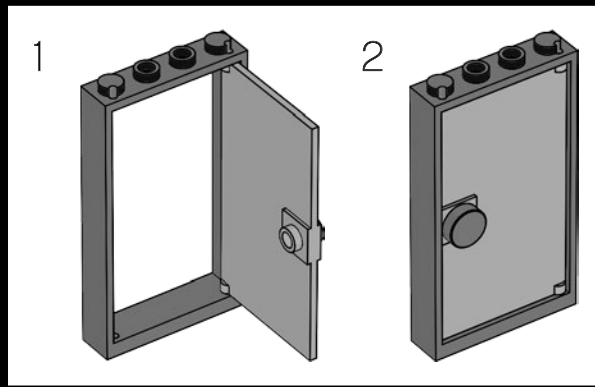

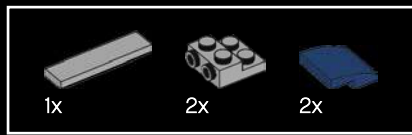

46

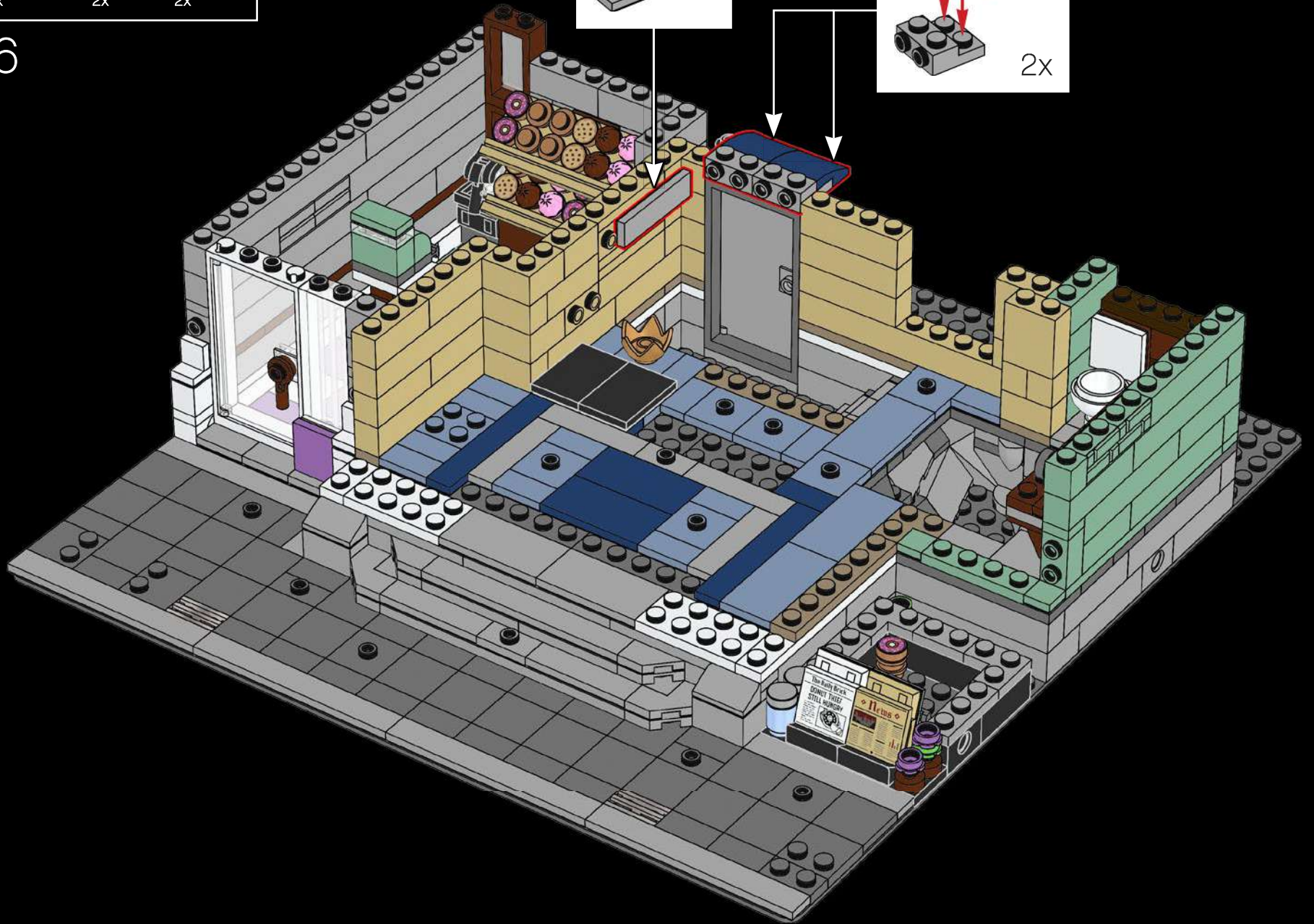
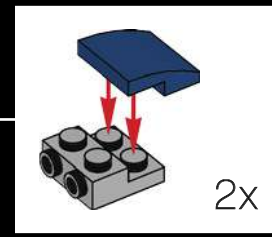
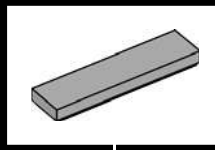







53



54

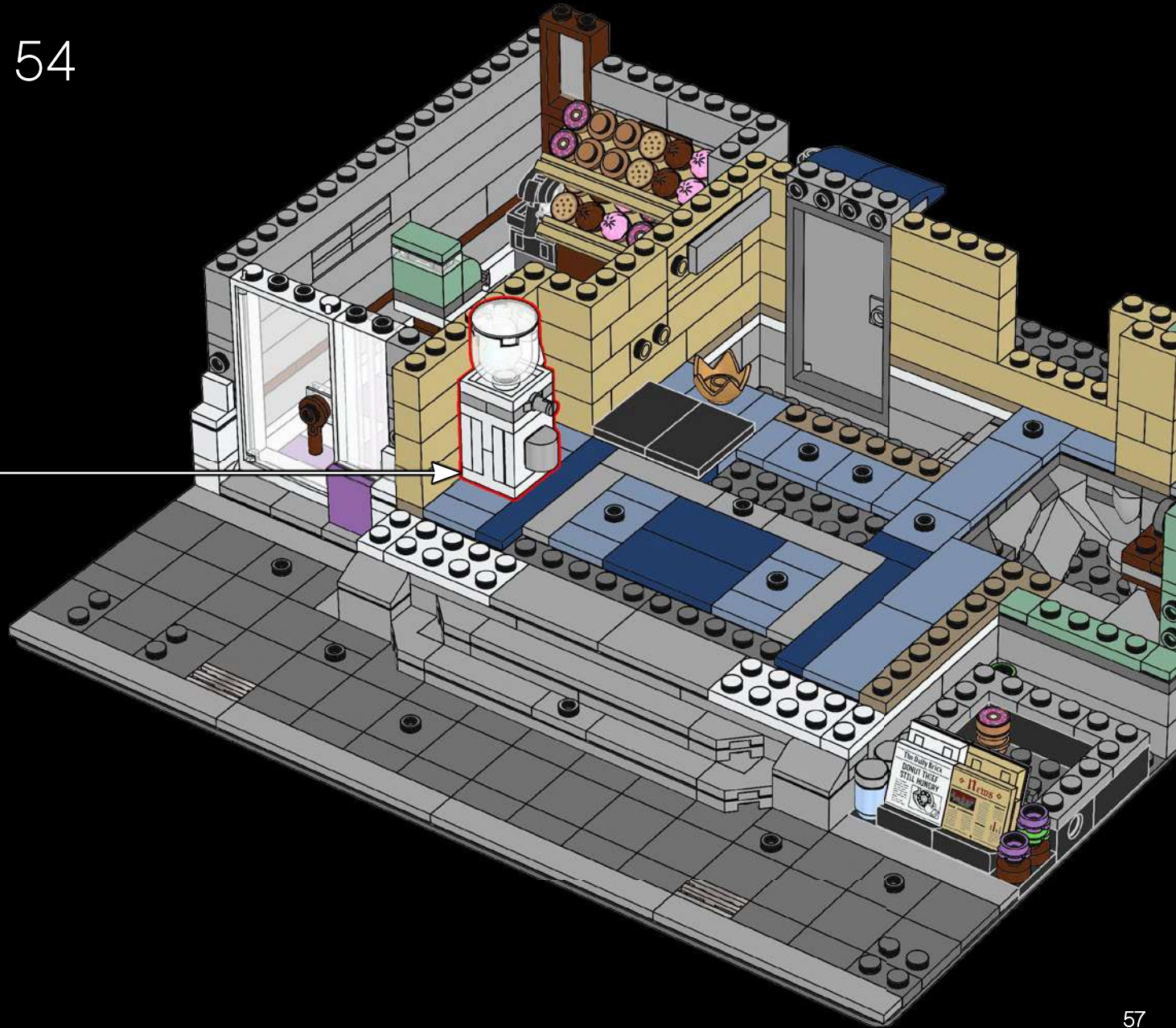

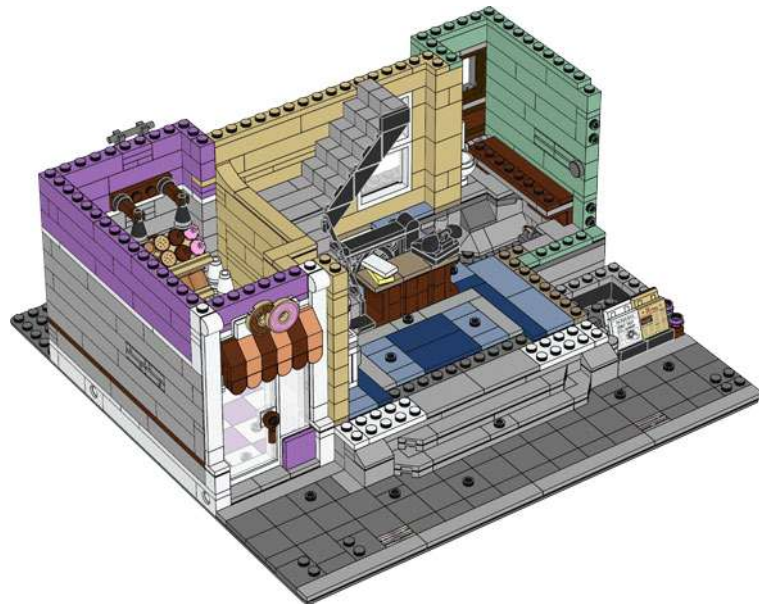

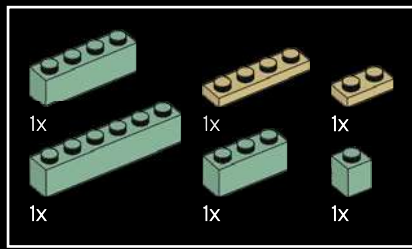

55



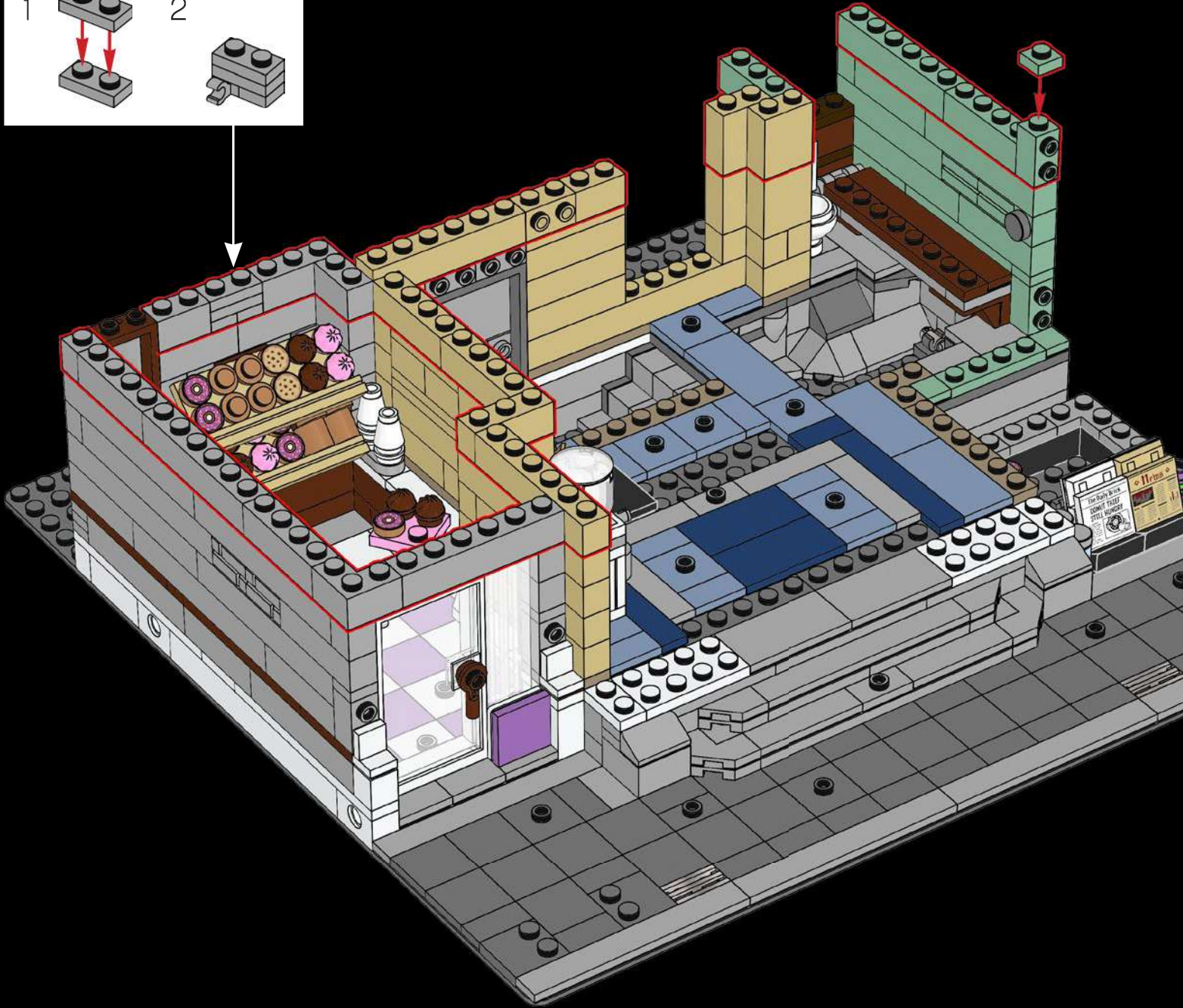
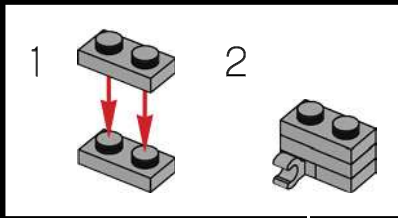
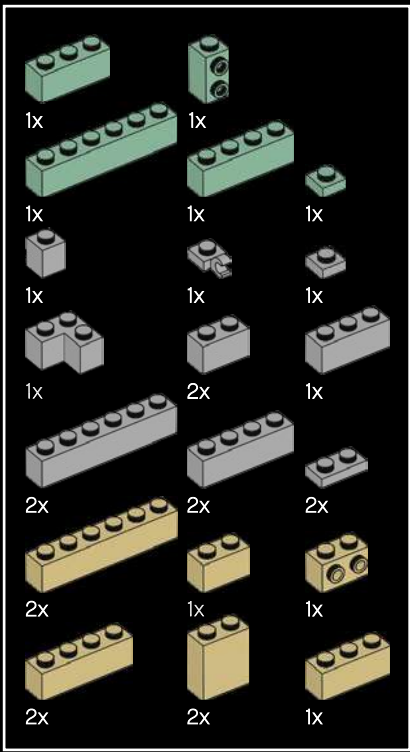

56



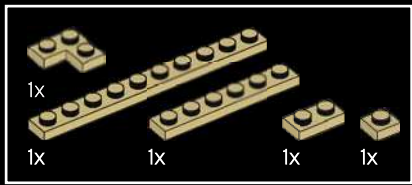

58

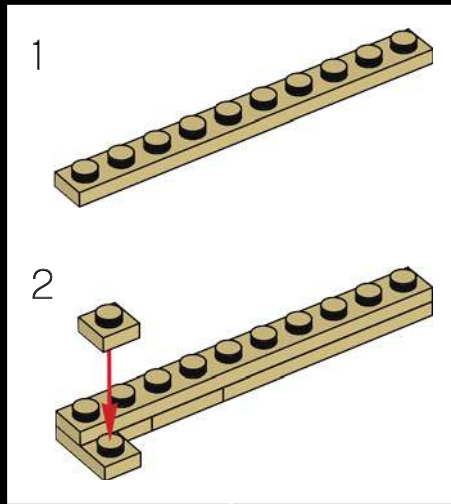

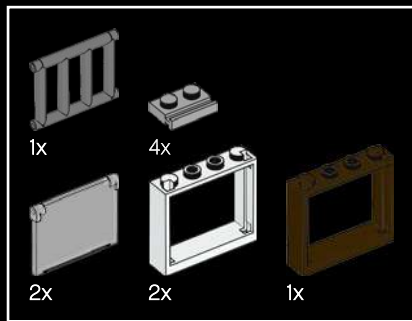

59

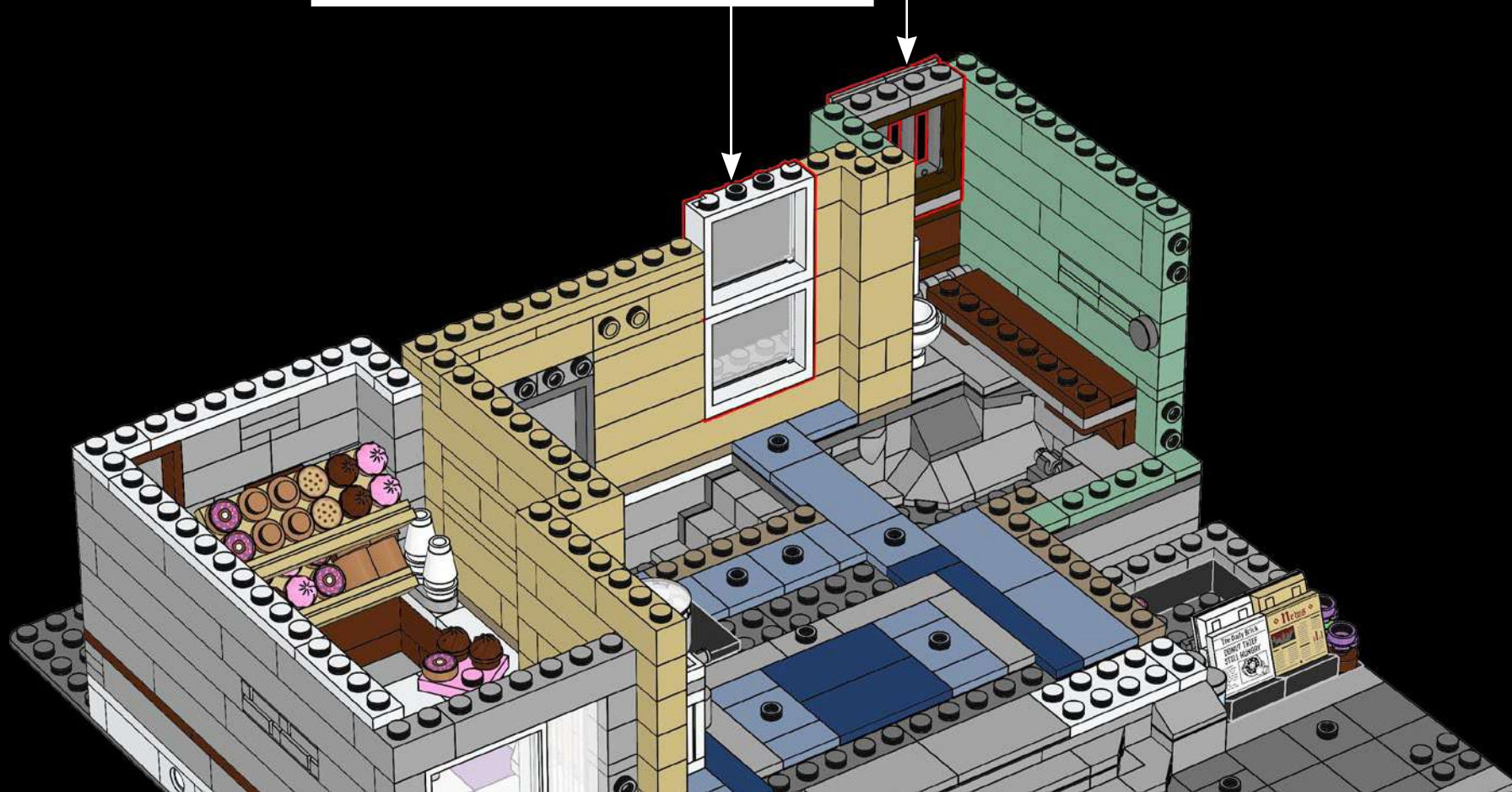
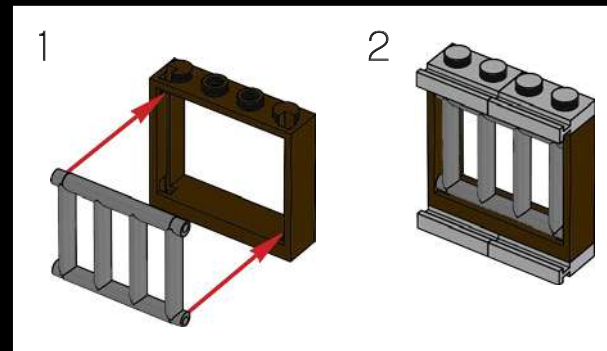
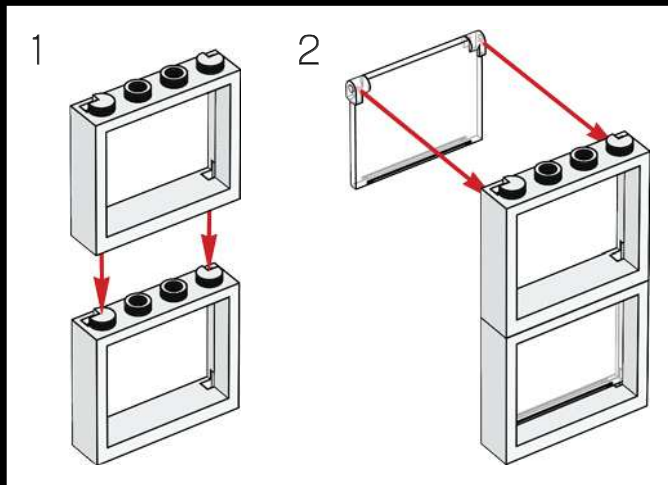

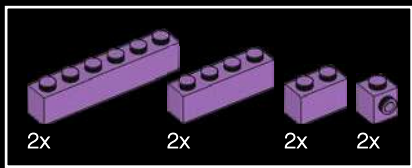

60

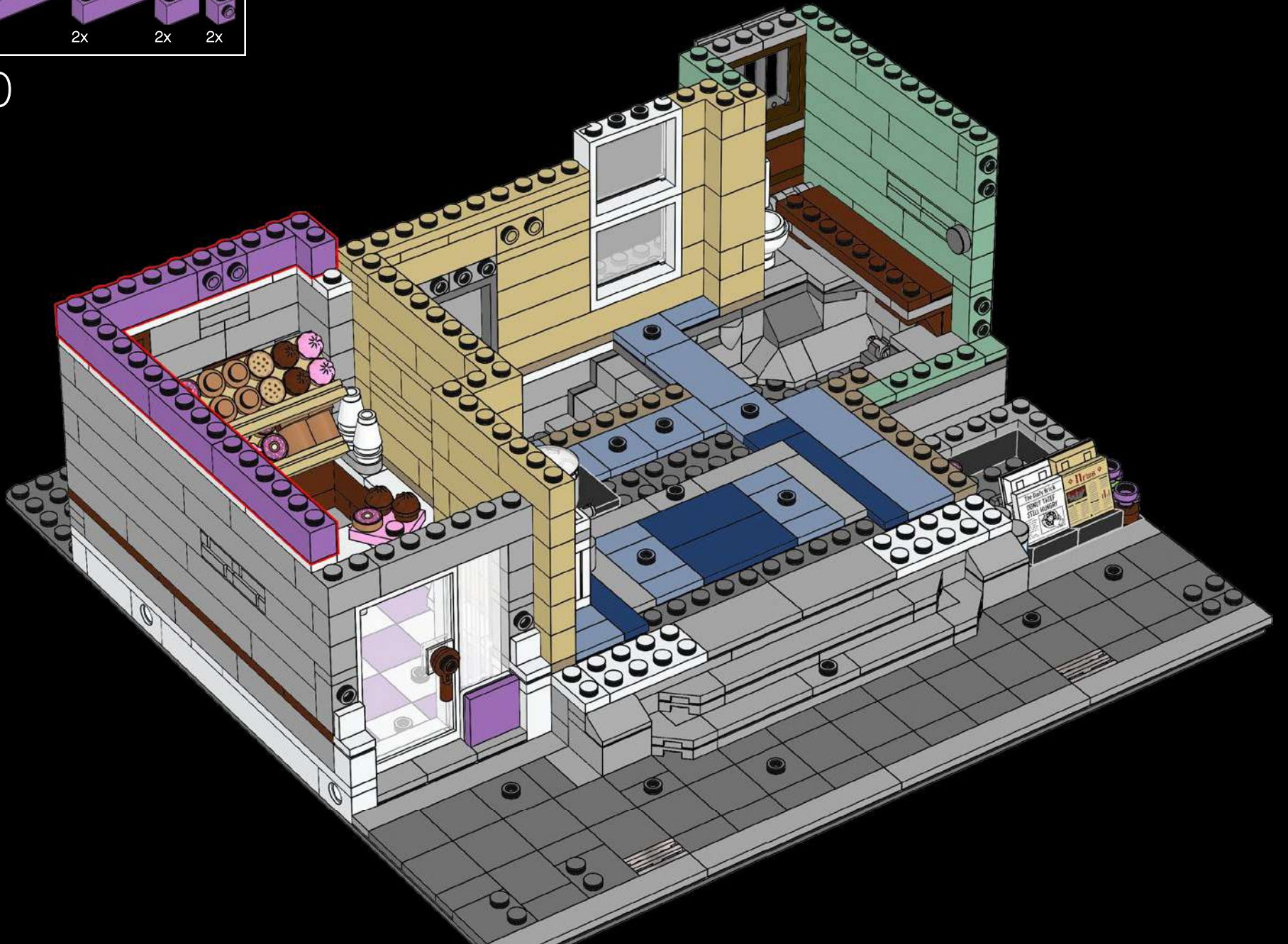



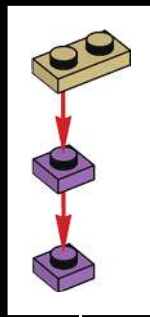
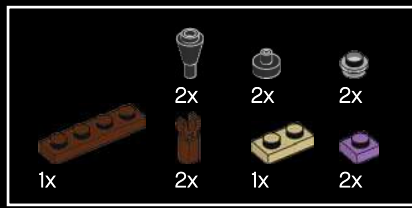

61

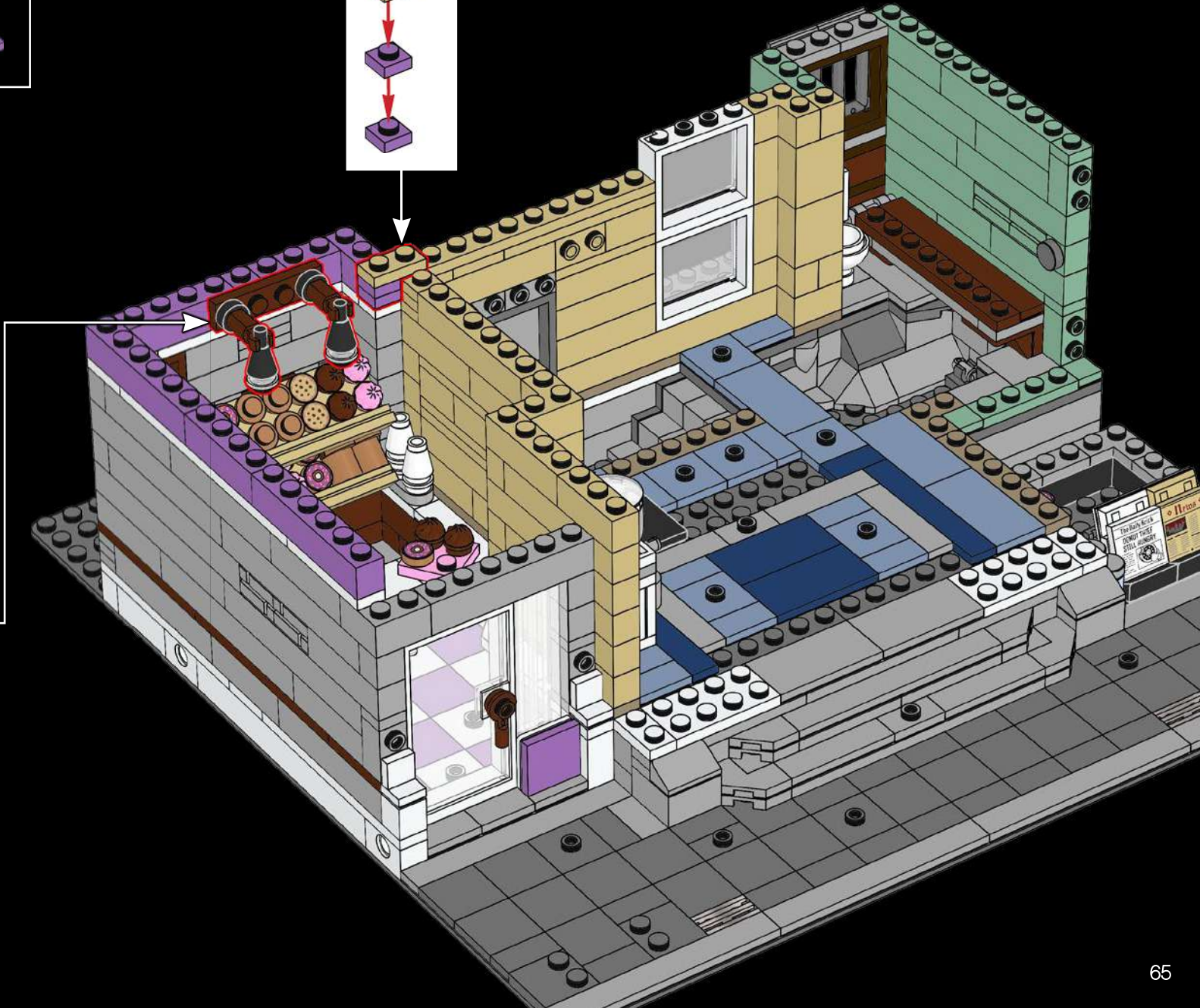
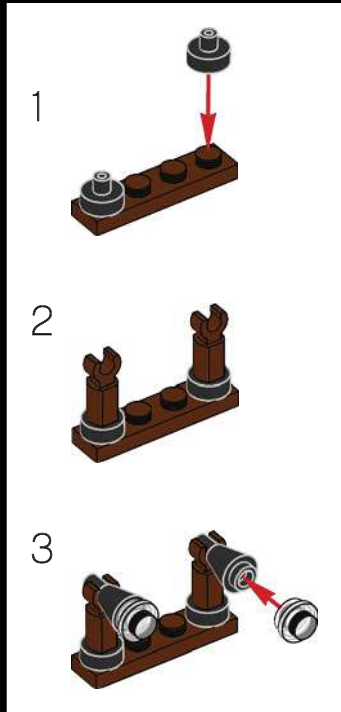

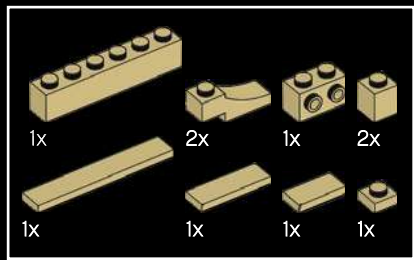

62

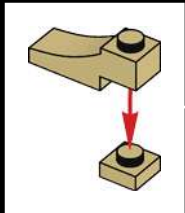
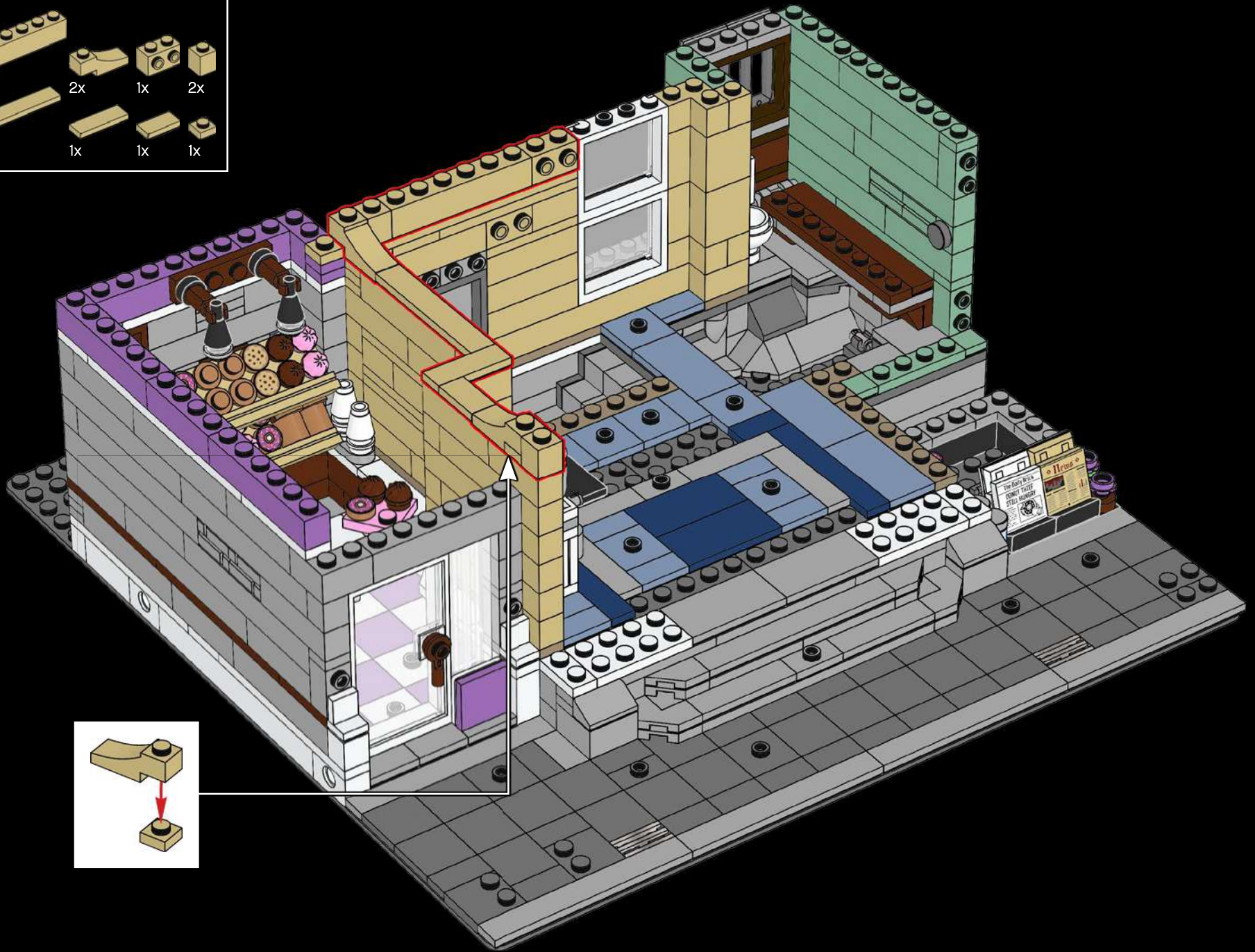





68

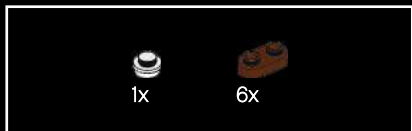
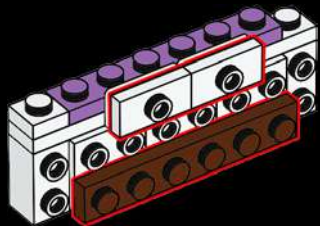

69

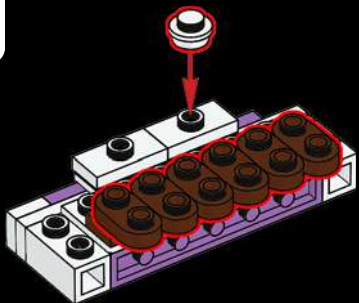

70

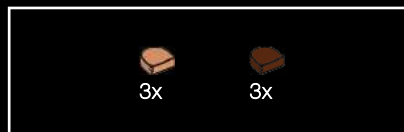
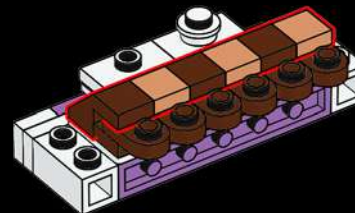

71

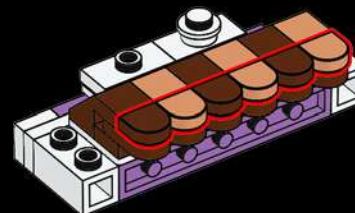

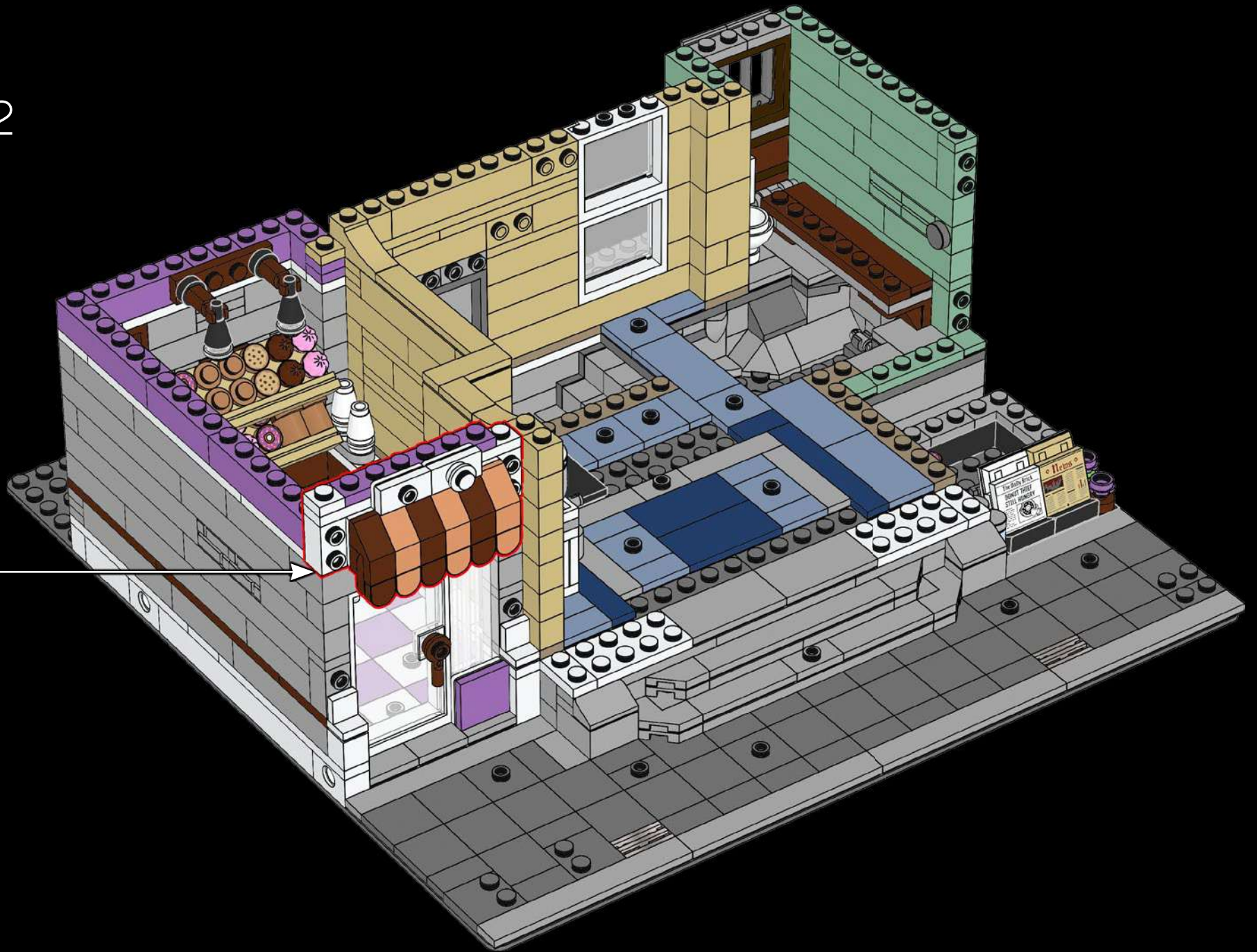

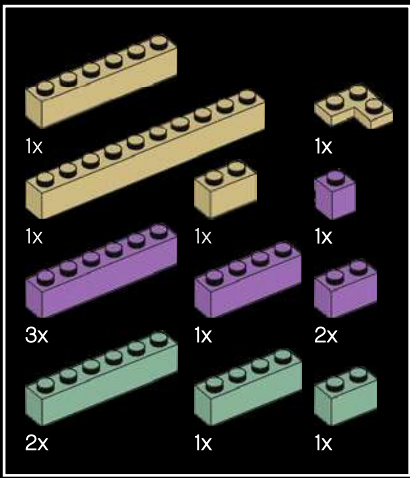

73

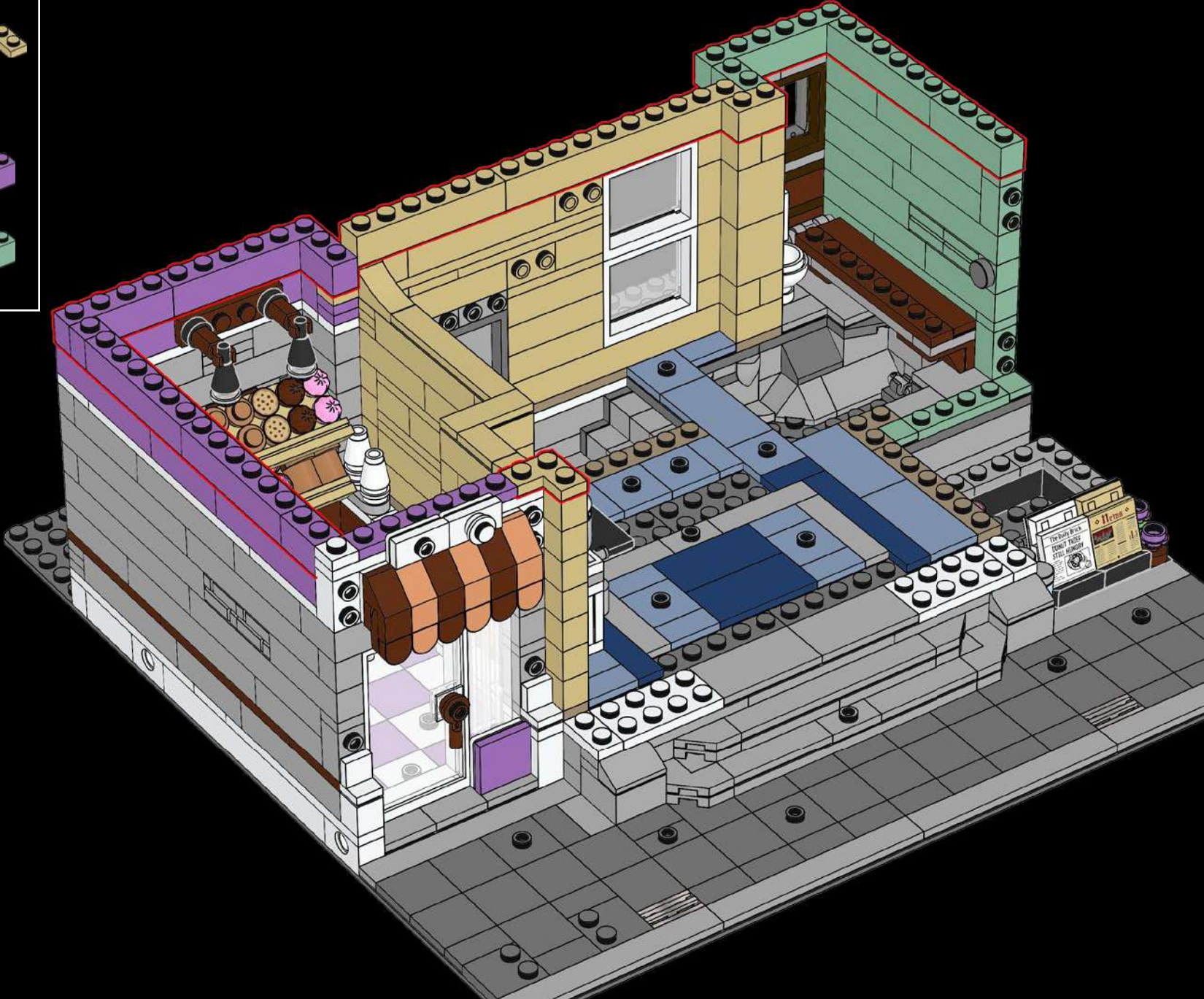

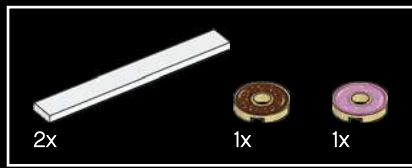

74



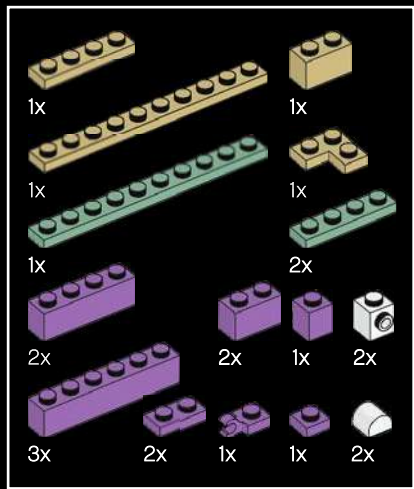

75

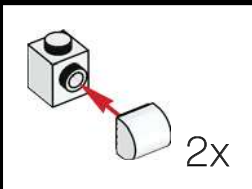
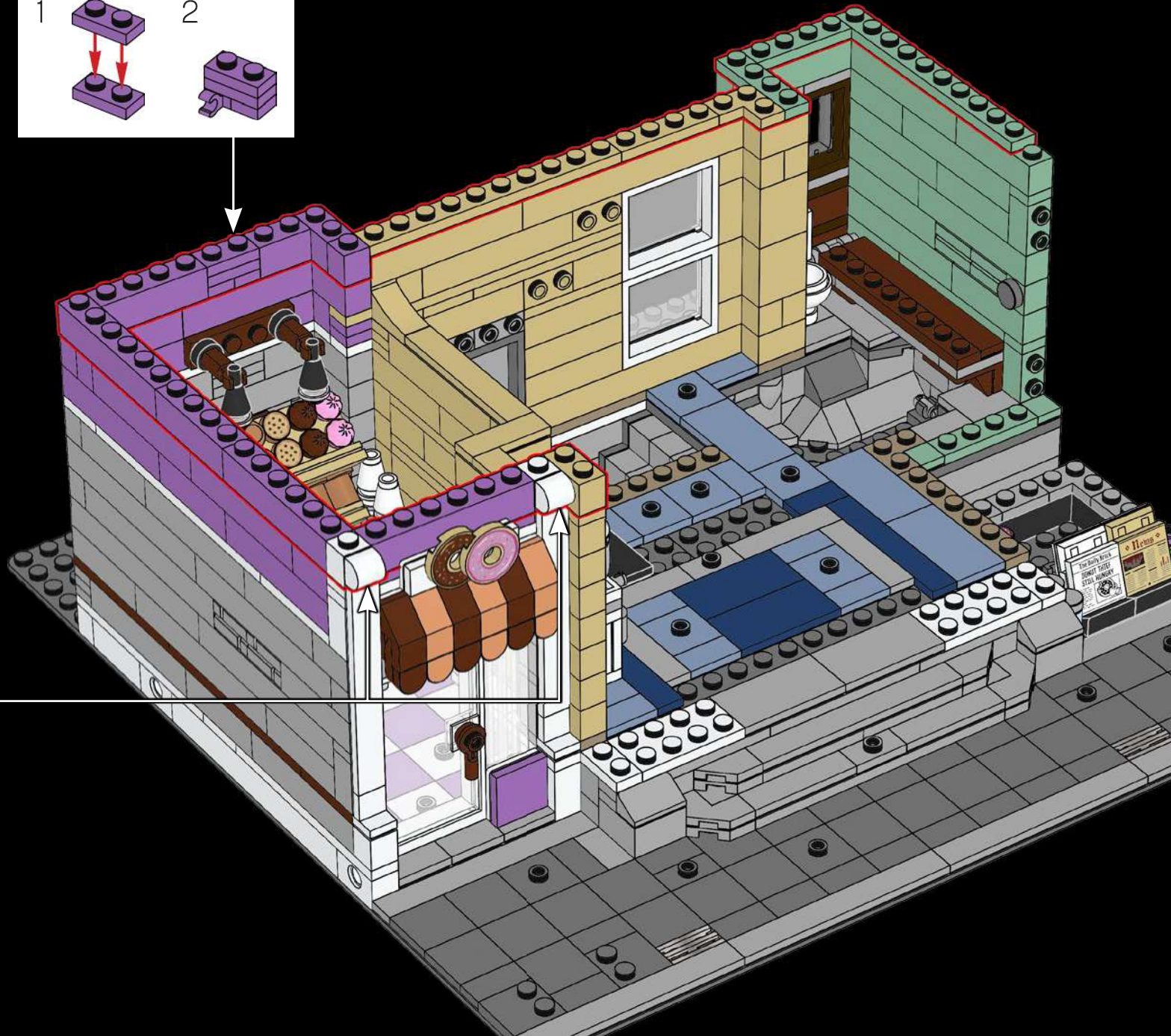
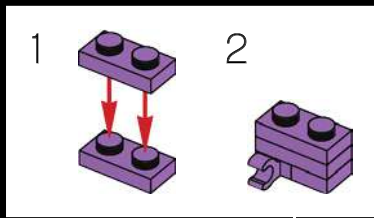



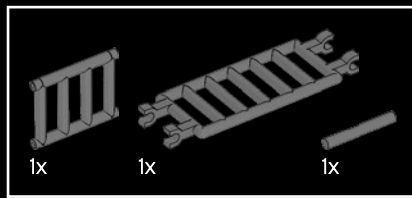

76

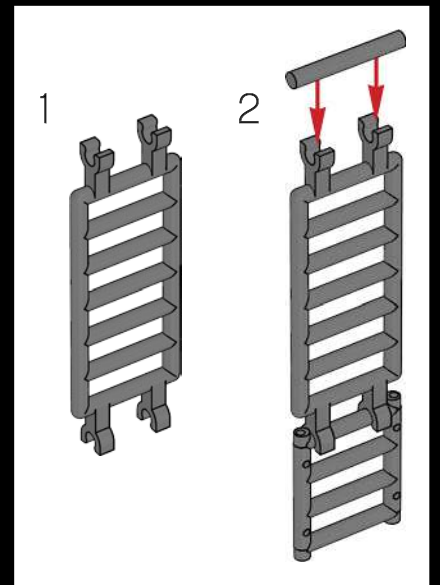

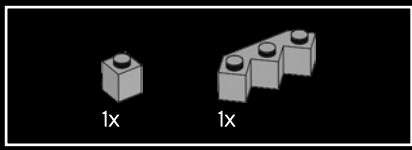

77

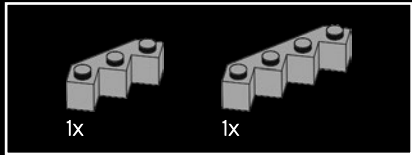
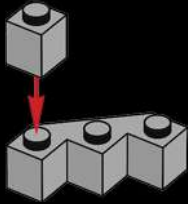

78

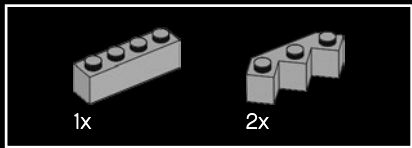
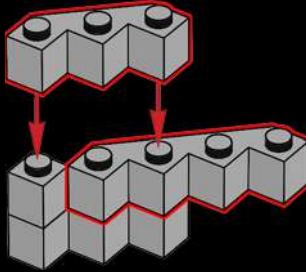

79

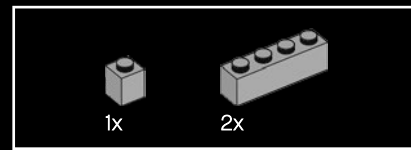
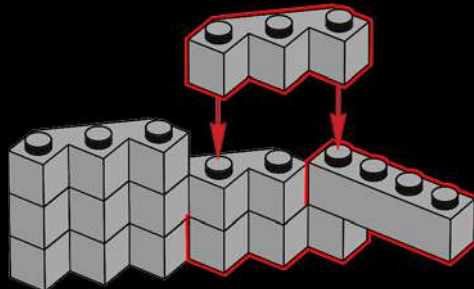

80

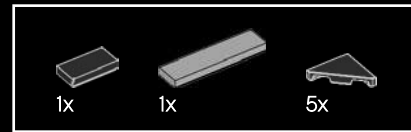
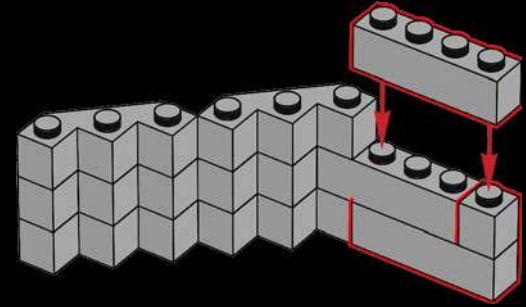

81

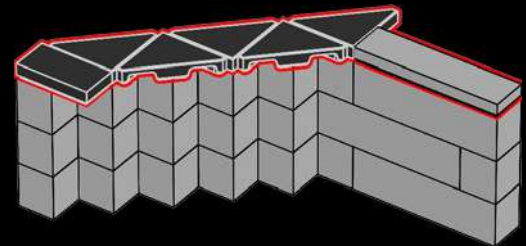

The station's grand staircase is constructed with facet bricks that have been flipped on their sides.

82

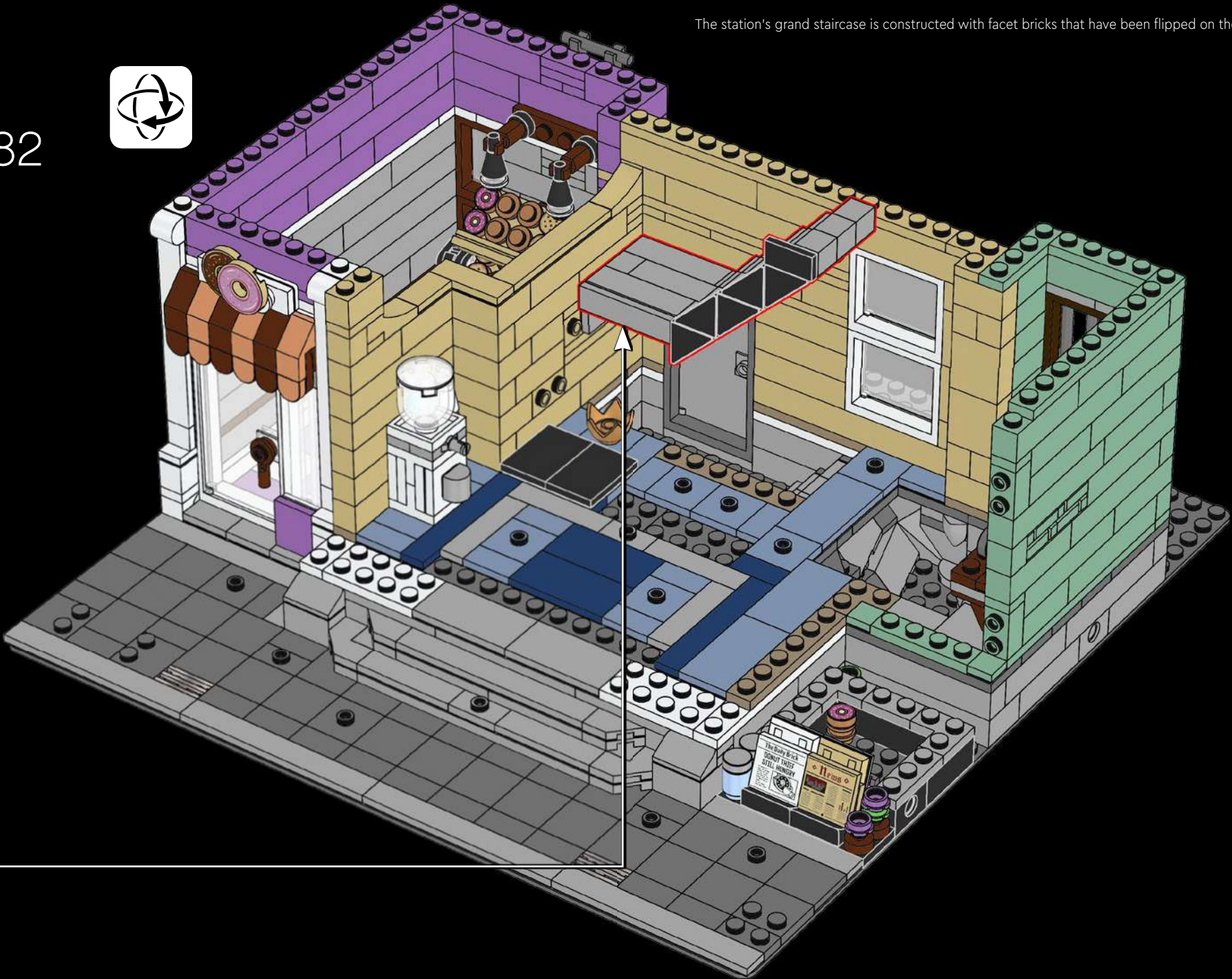

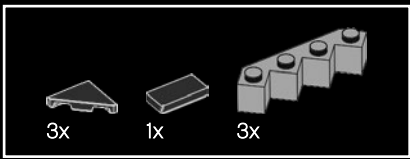

83

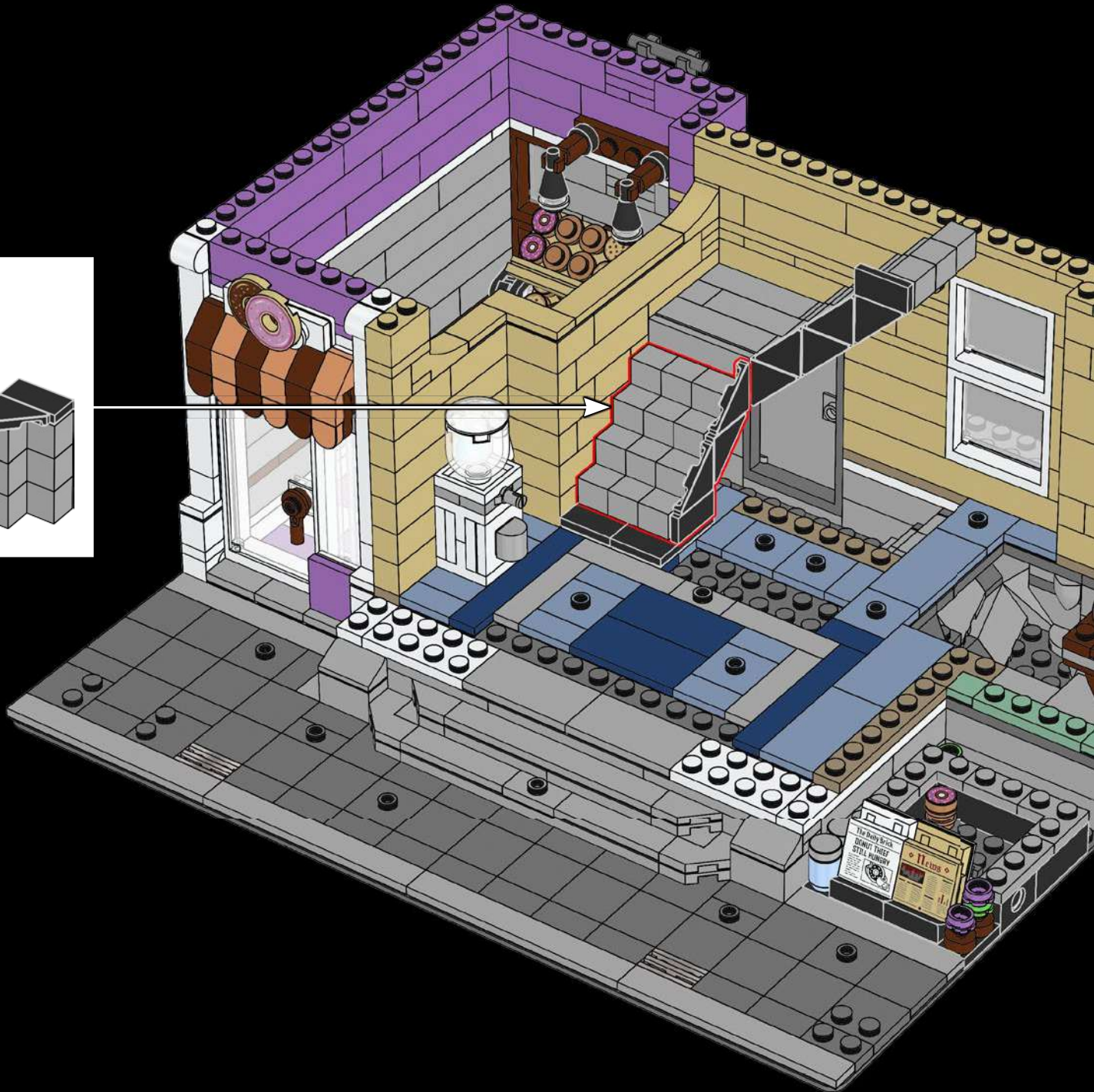
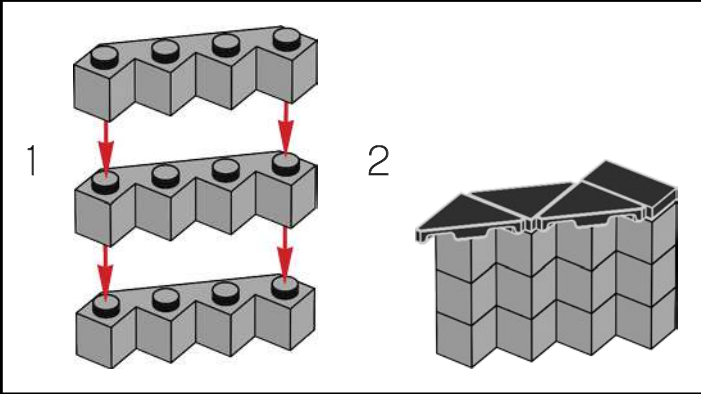

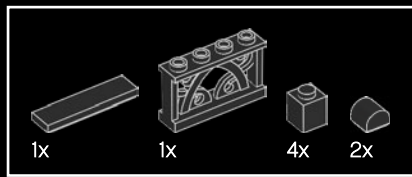

84

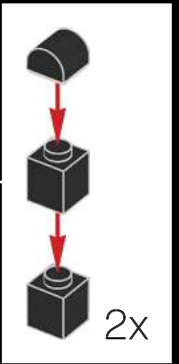
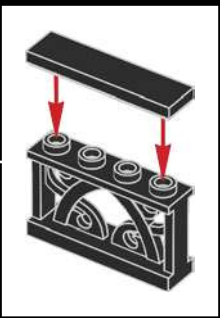
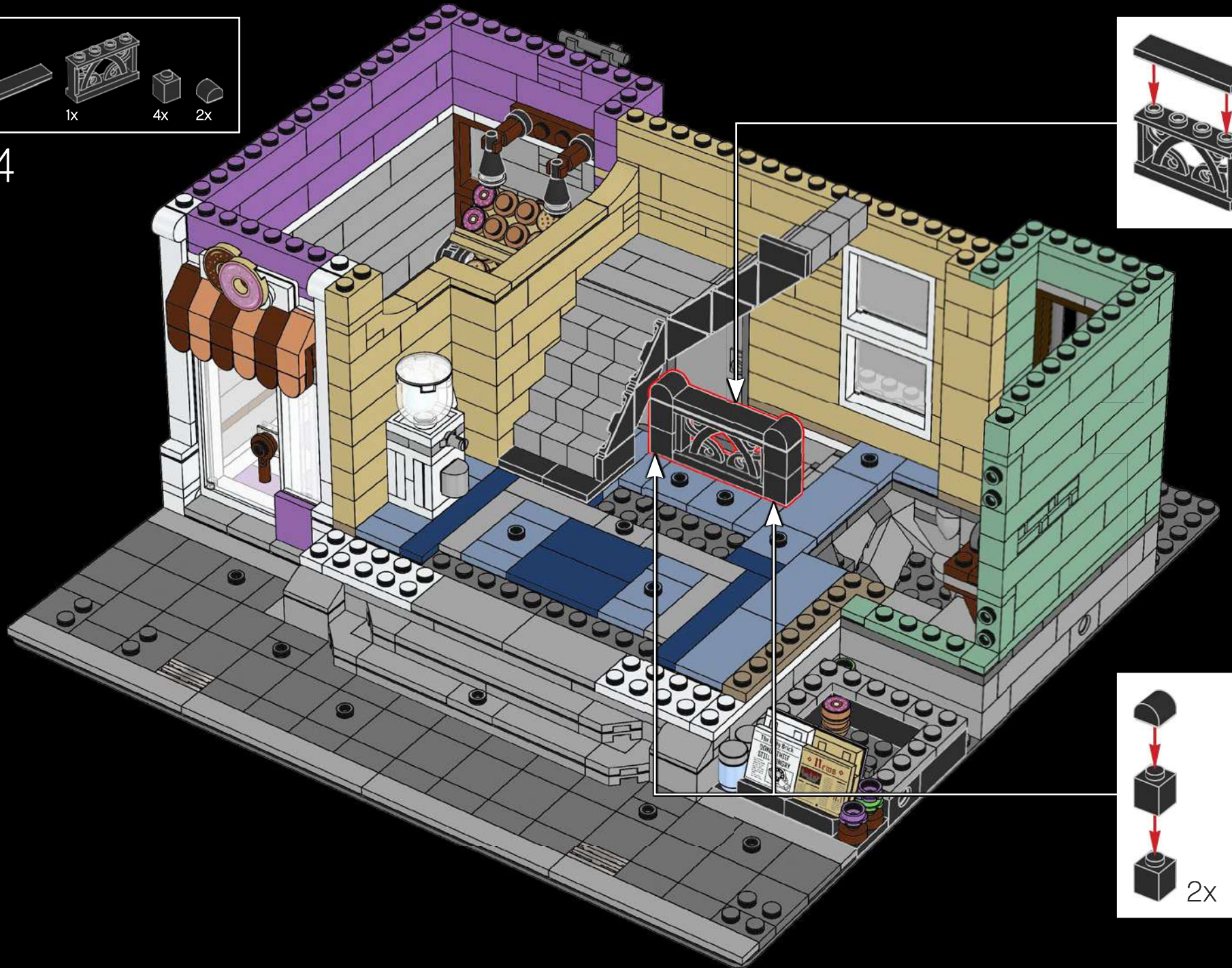



Whether it's movies, television, or LEGO® sets, rotary telephones really communicate the time period of the story.

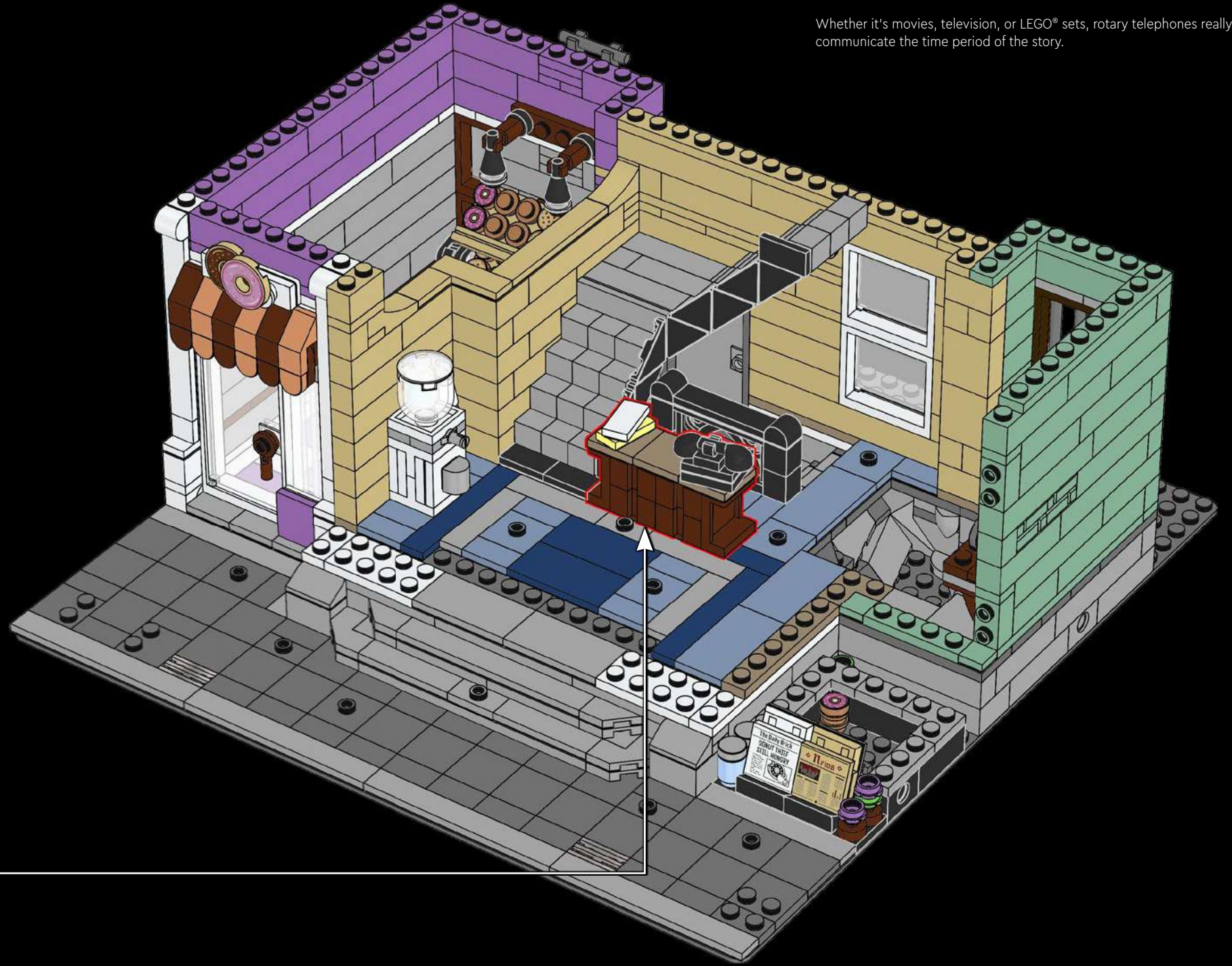

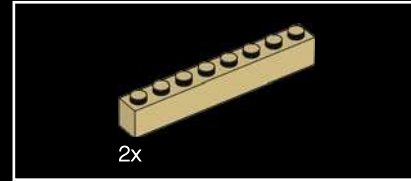
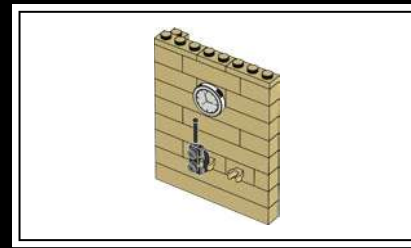
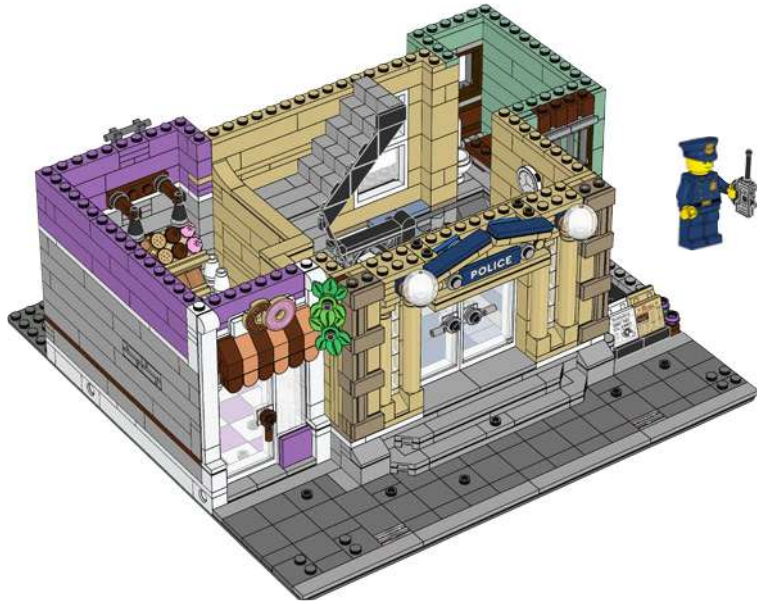
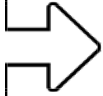

2x

86

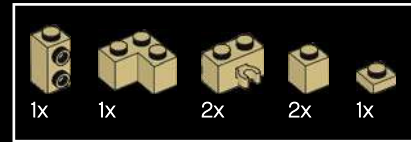
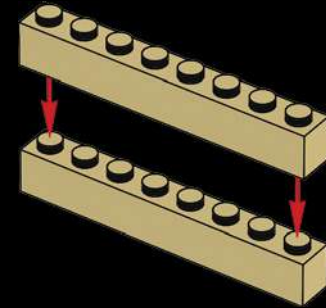

87

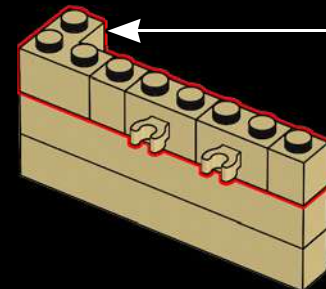
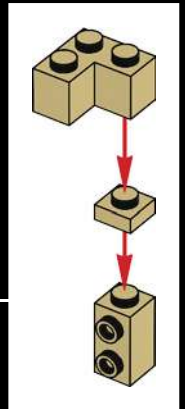

The fresh-faced constable is a recent graduate from the academy.

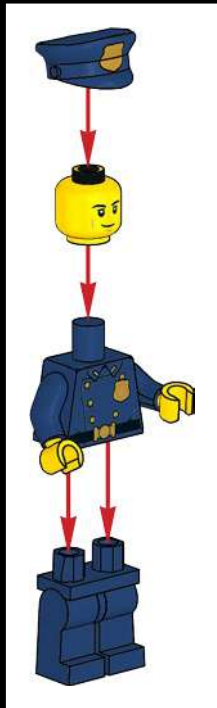



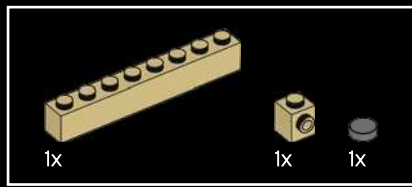

88

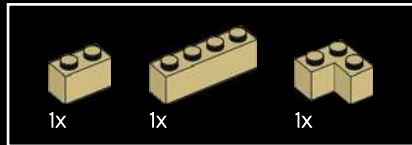
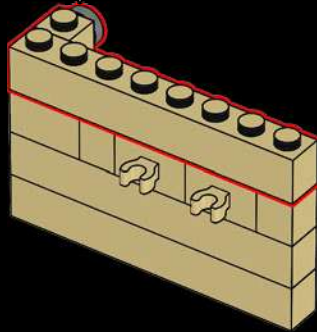
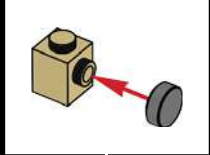

89

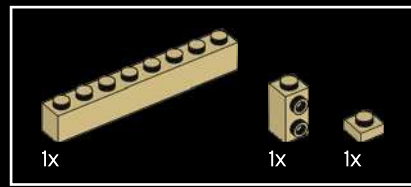
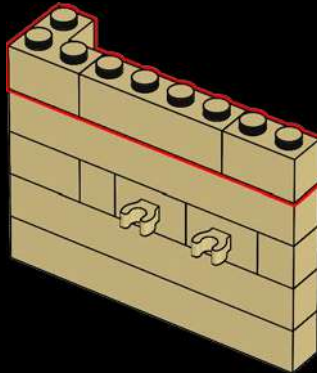

90

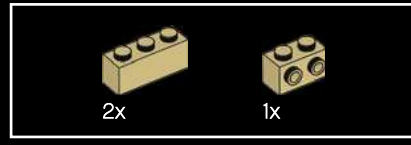
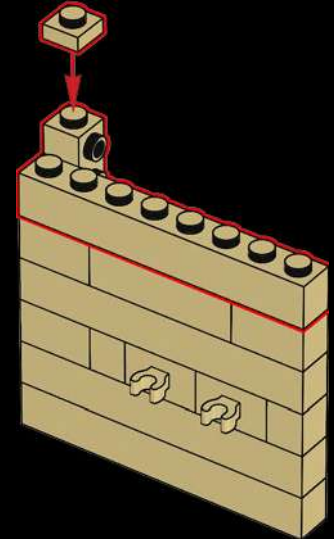

91

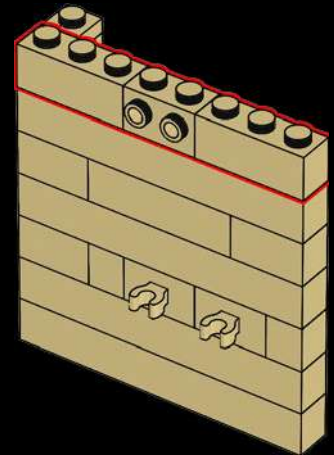

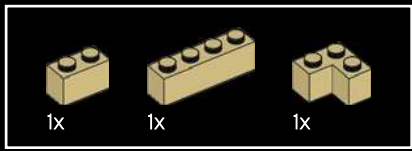

92

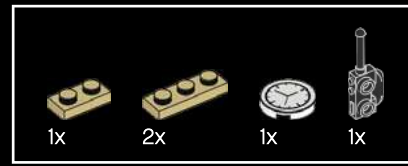
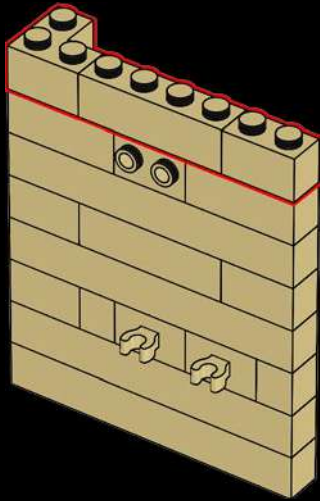

93

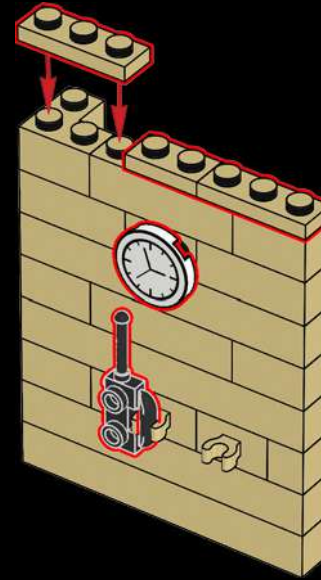

94



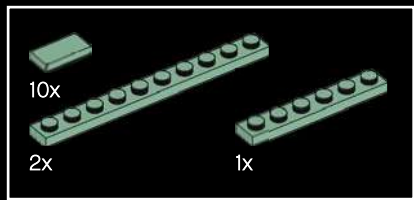

95

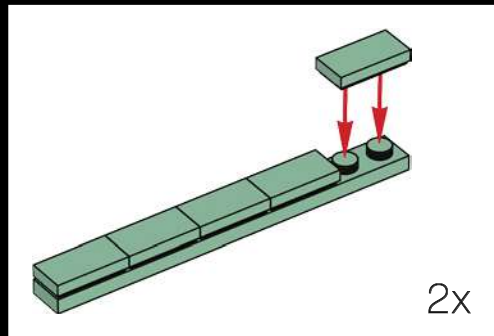
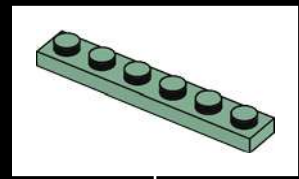
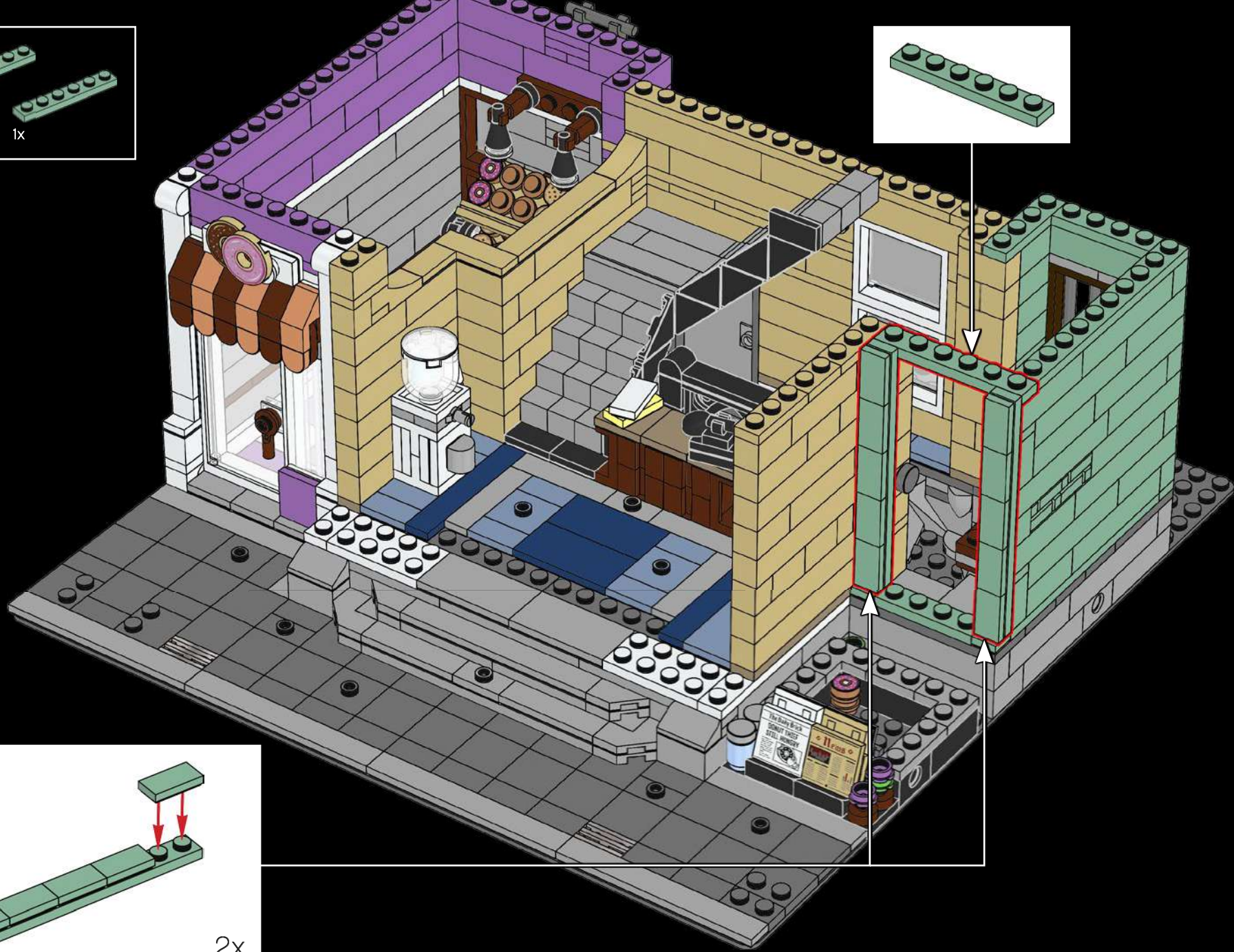

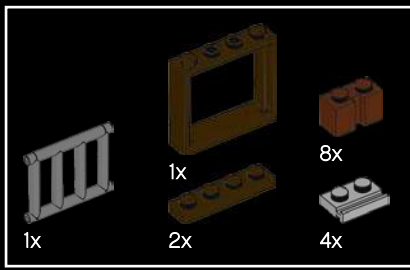

96

1

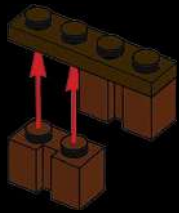

2



3

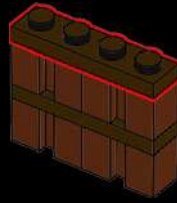

4



5

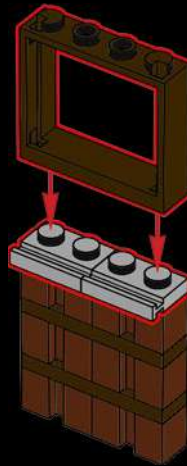

6

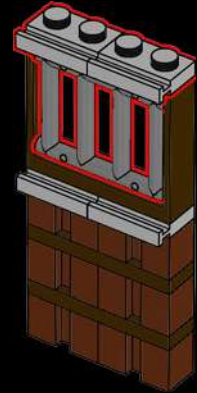

7

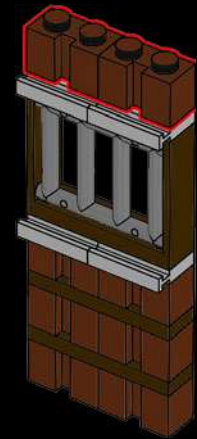



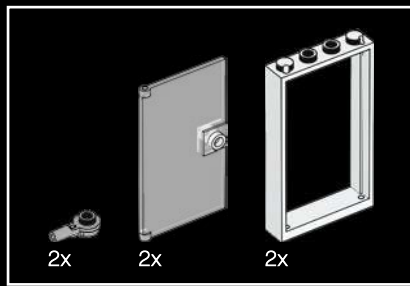

97

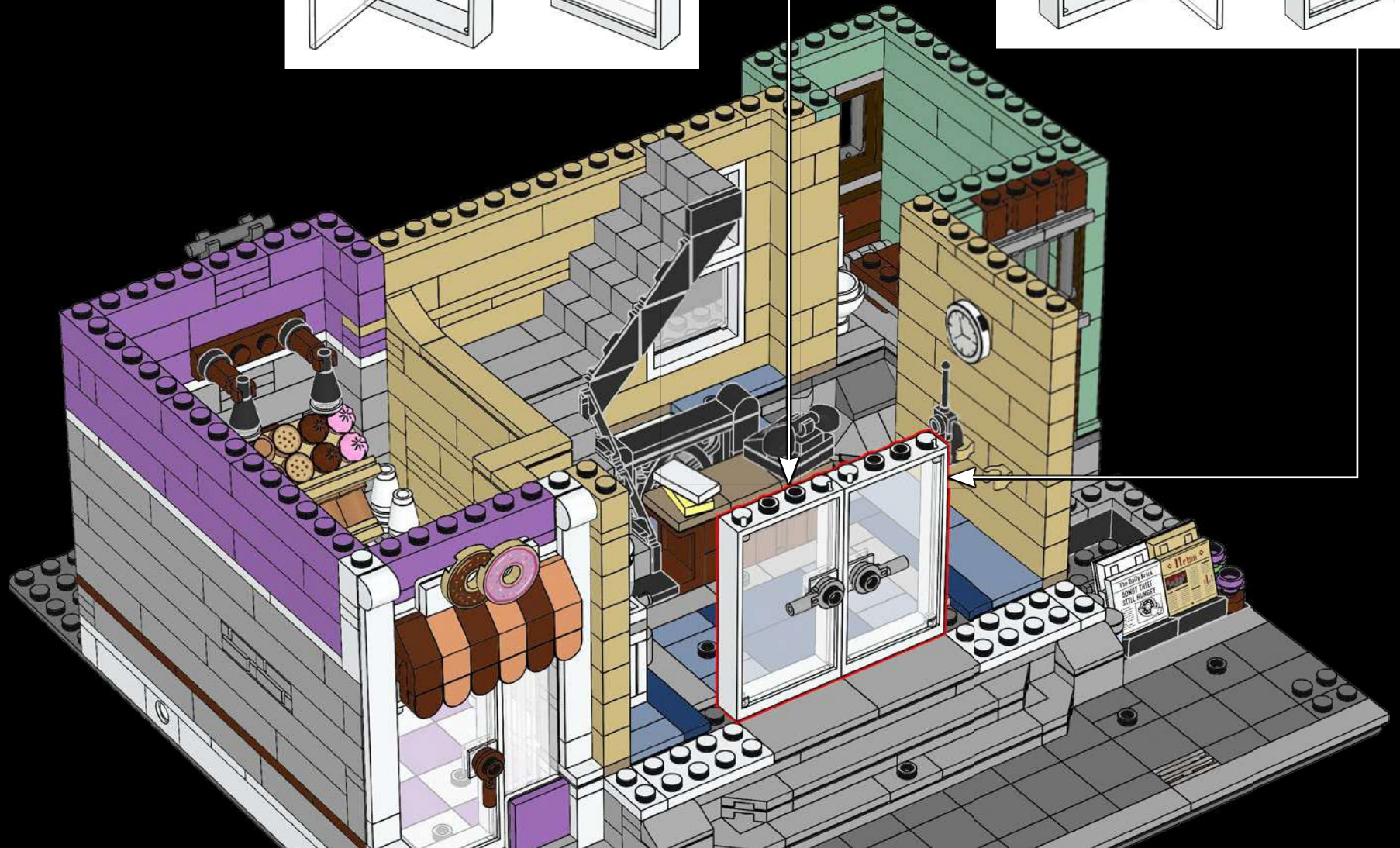
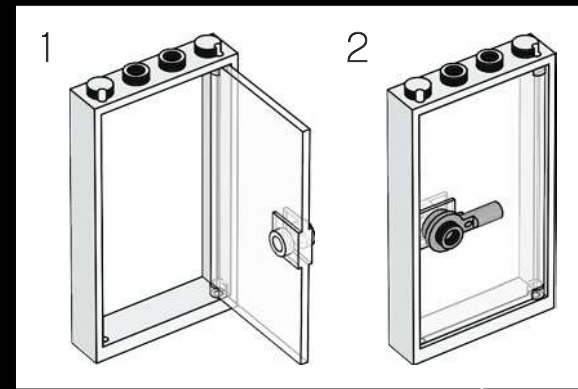
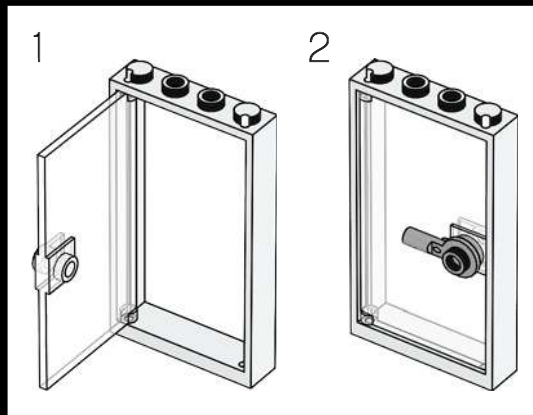



6x

98

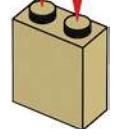
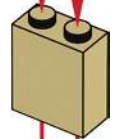
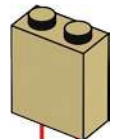
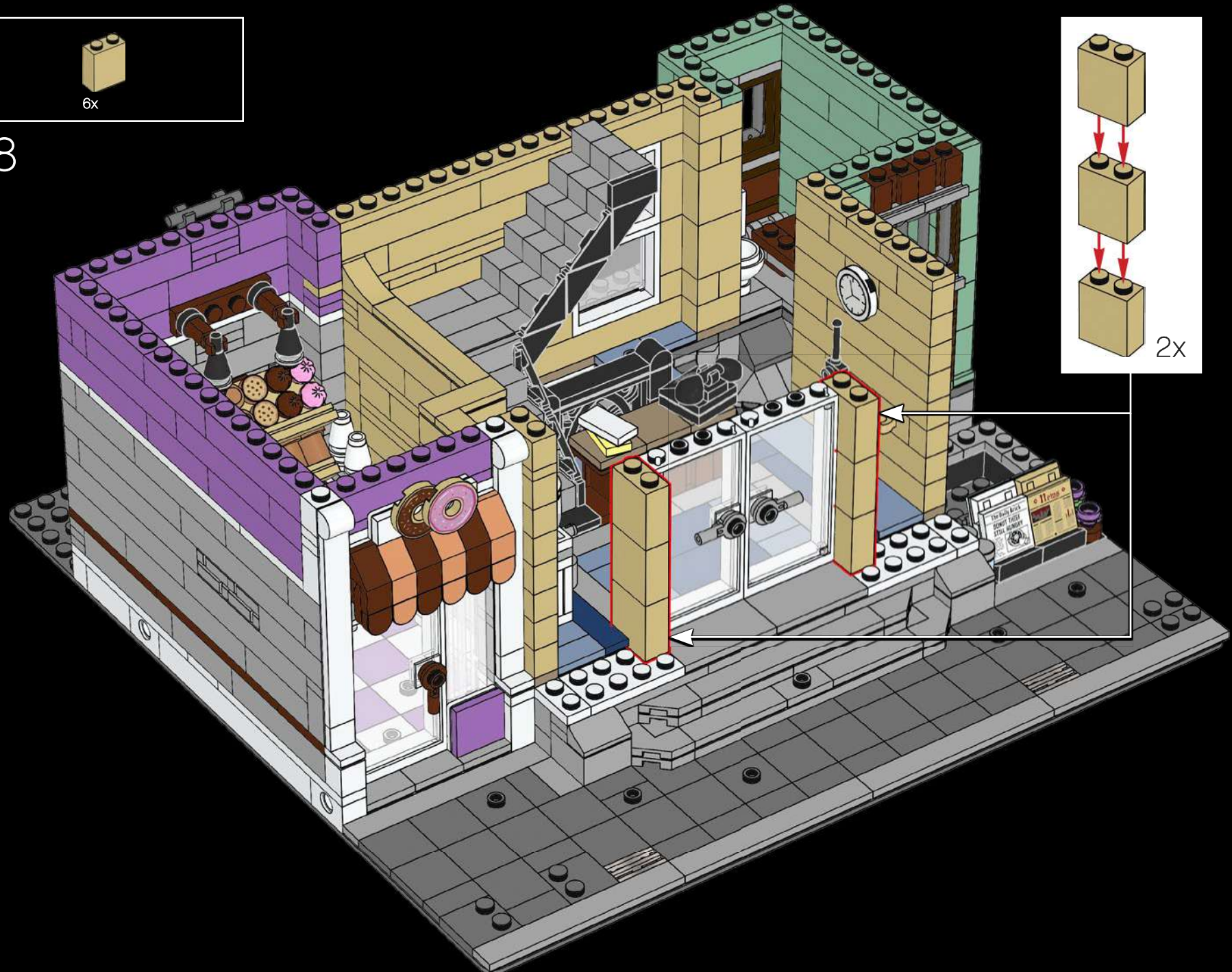

2x



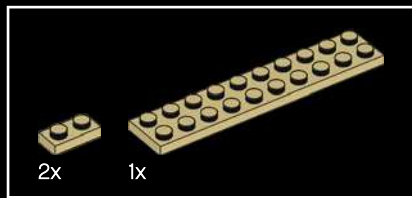

99

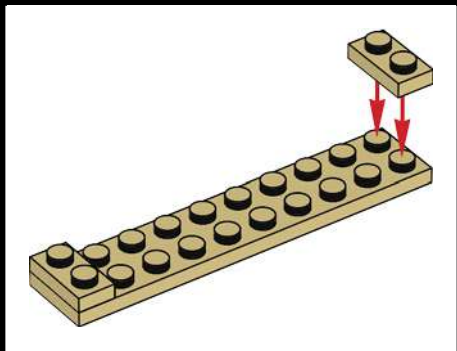
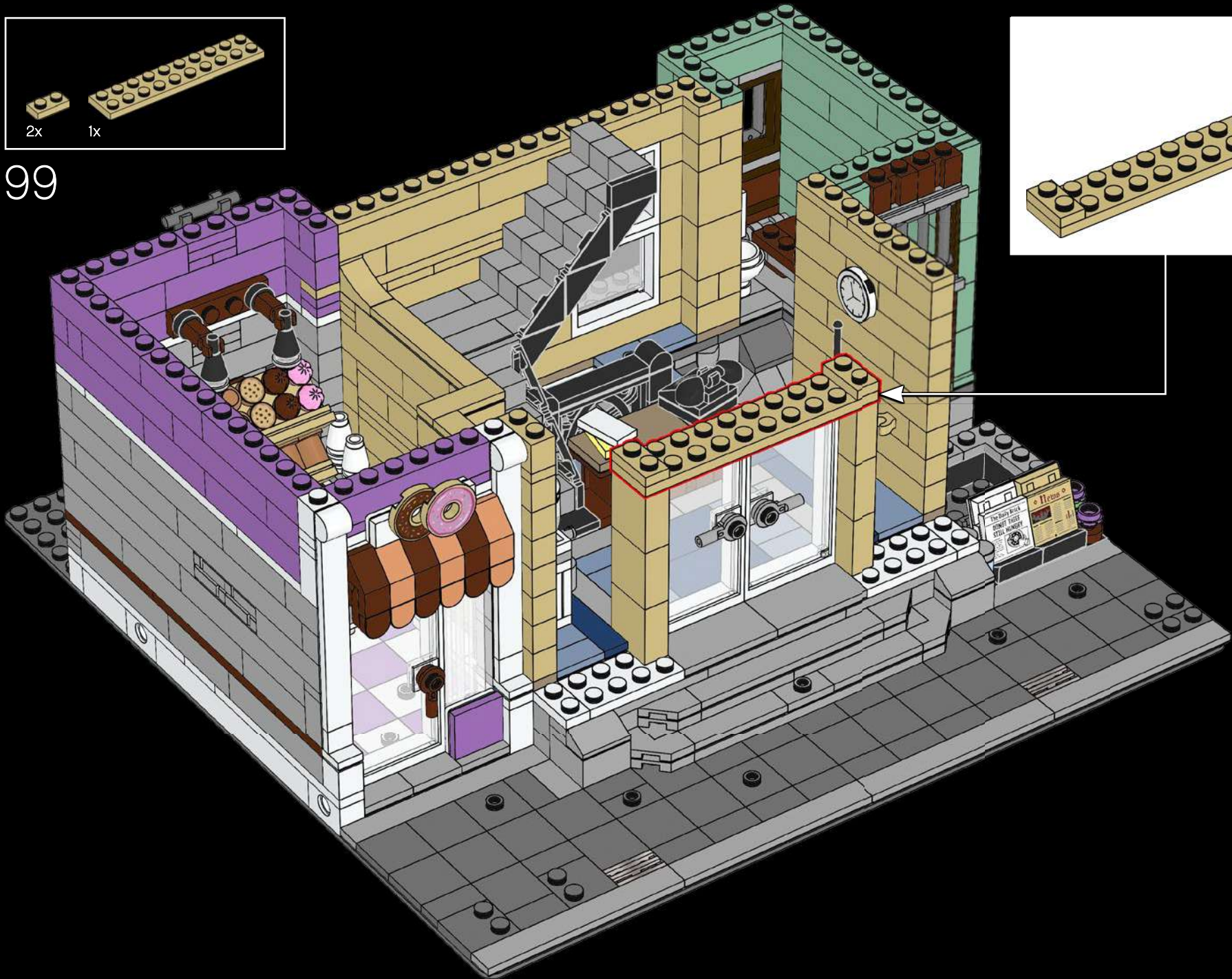

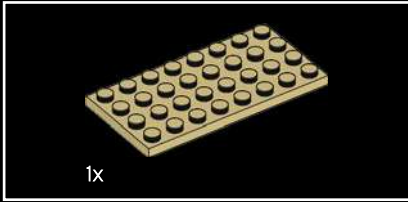

1x

100

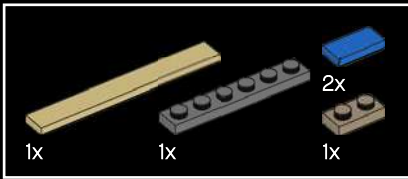
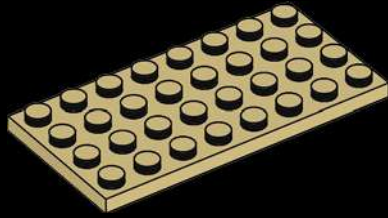

101

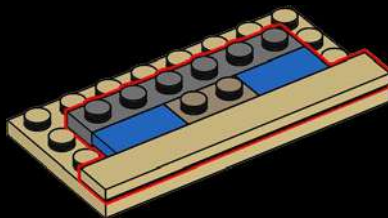

102

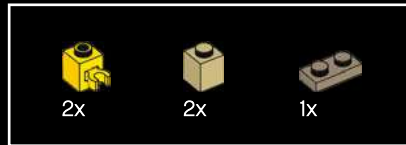
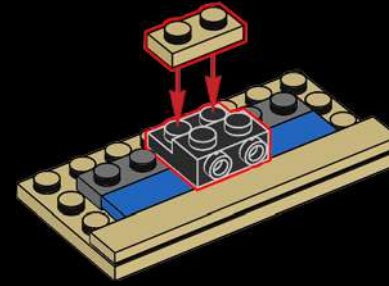

103

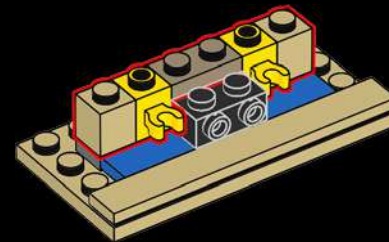

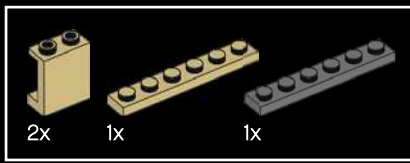

104

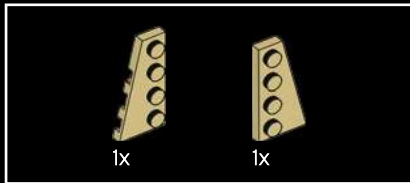
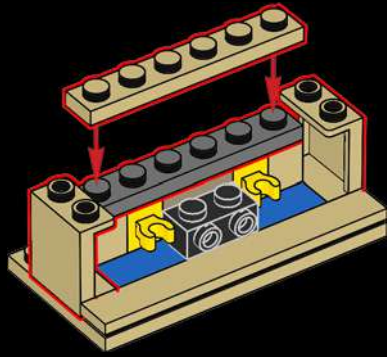

105

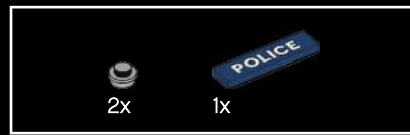
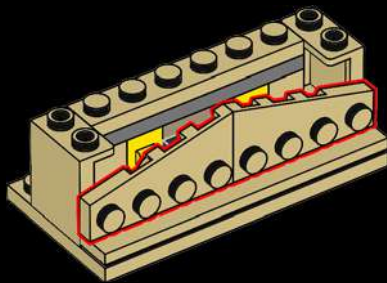

106

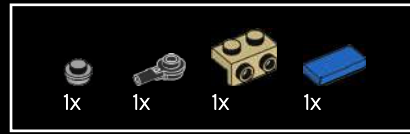

107

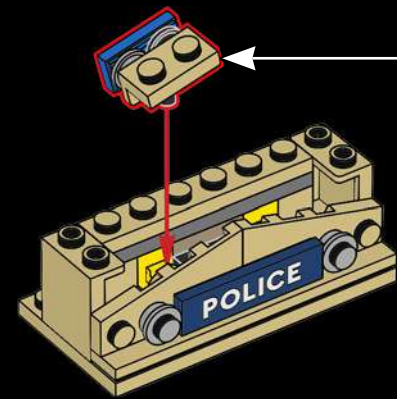



108

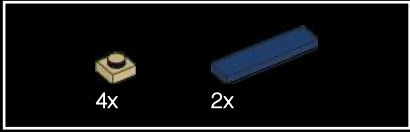
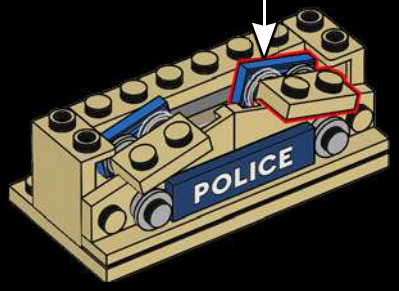

109

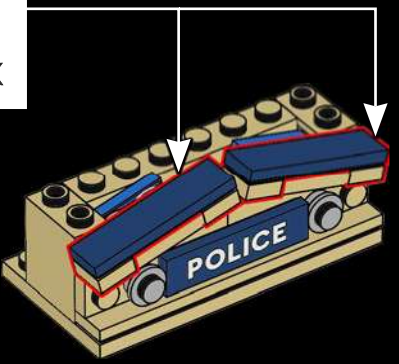
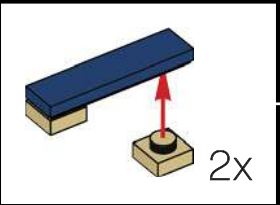

110

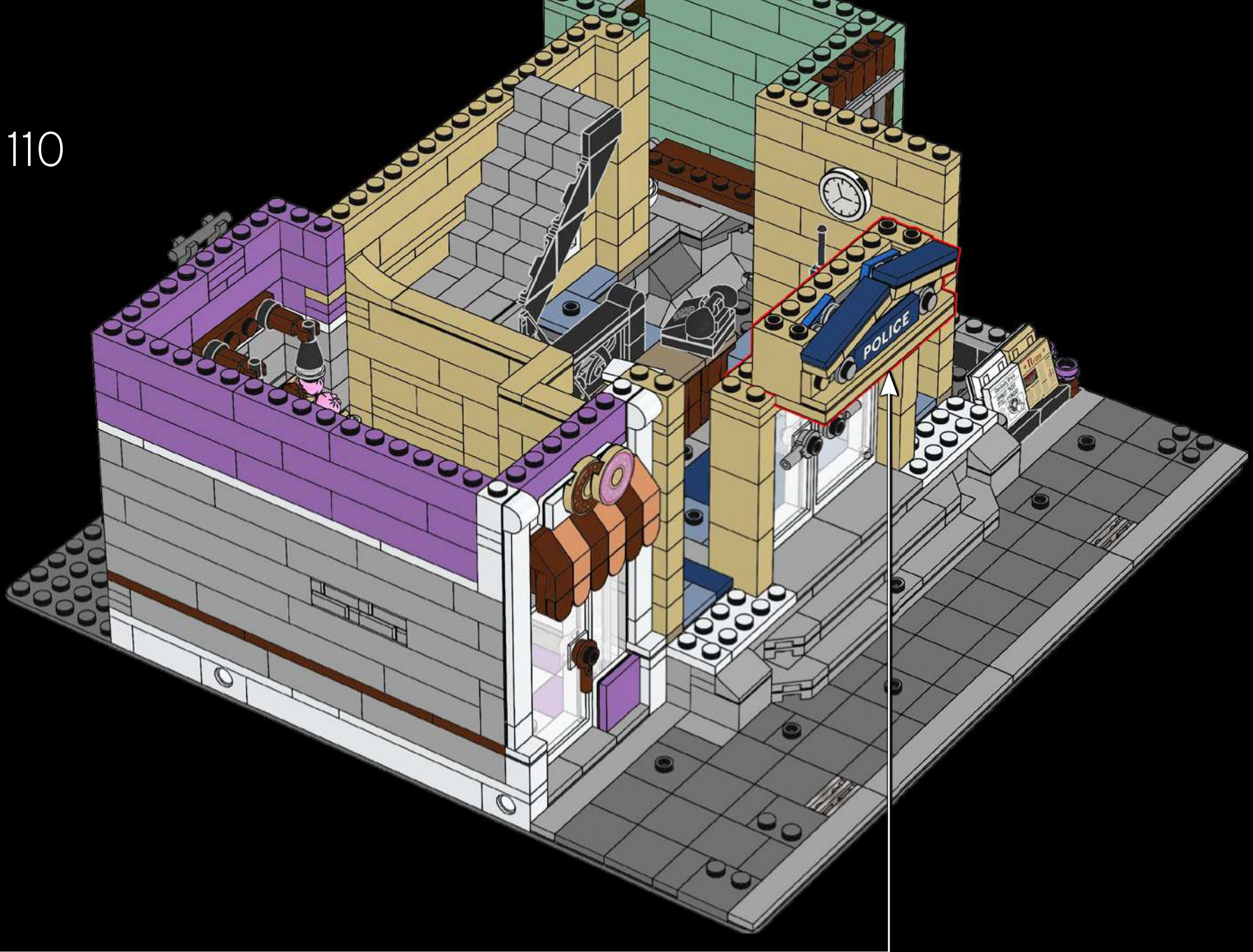



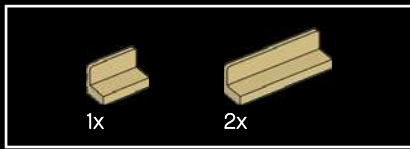

112



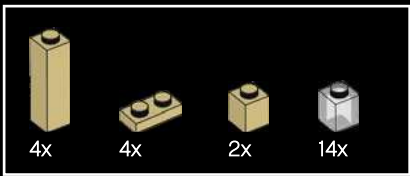

113

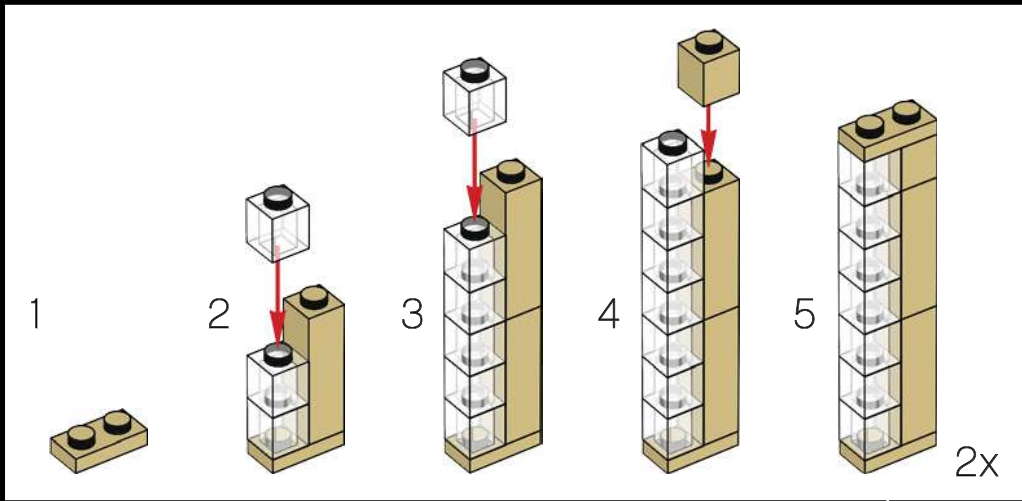



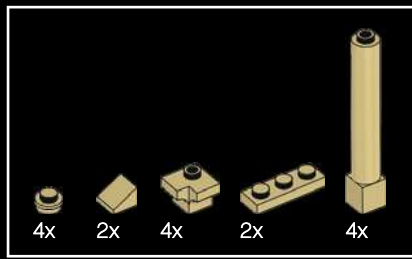

114

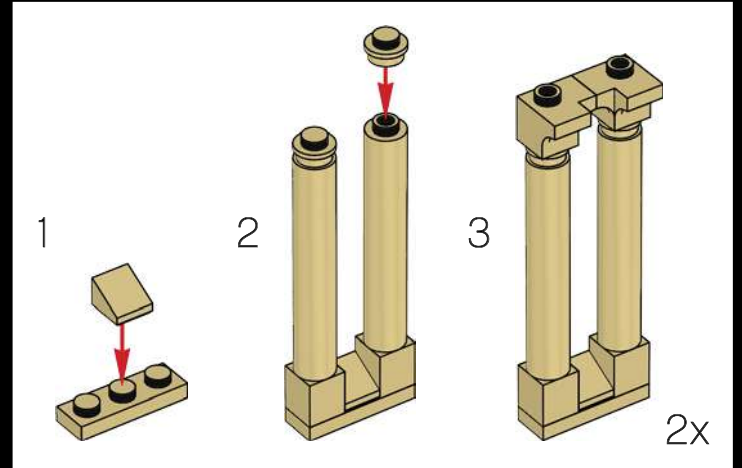
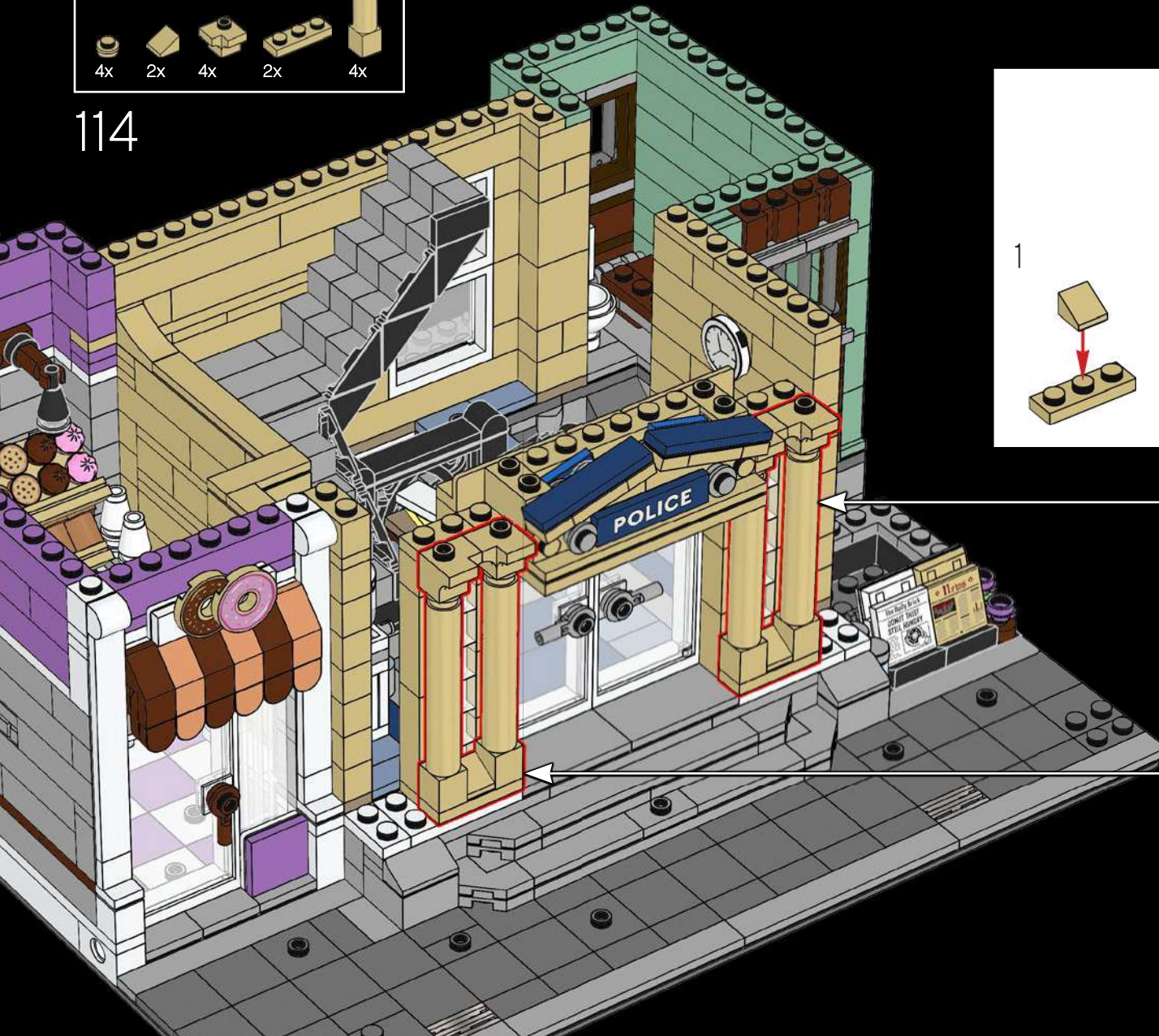

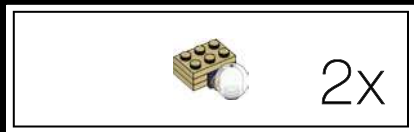

115

1



2



3

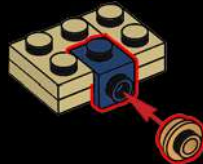

4



5

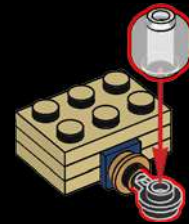

6



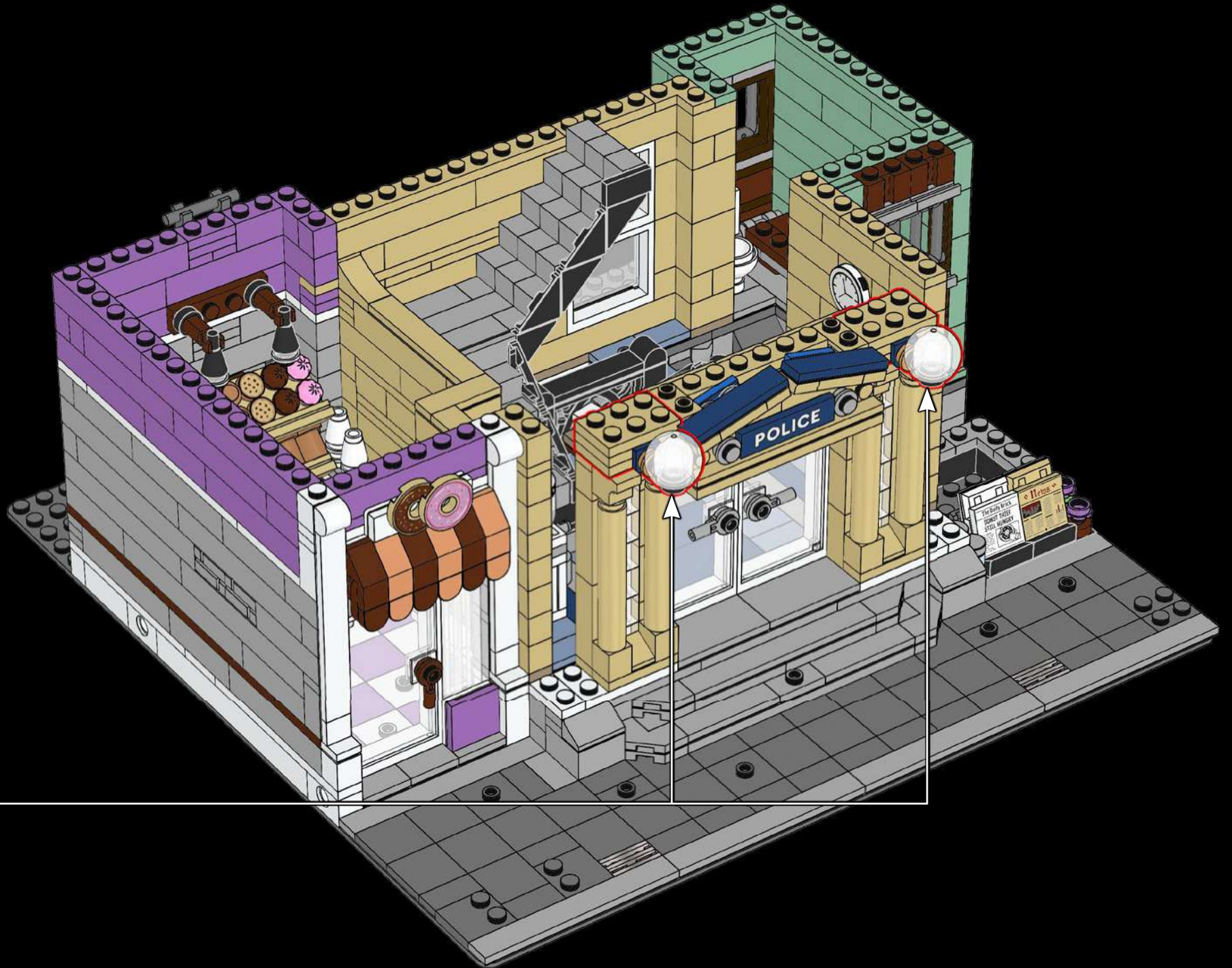

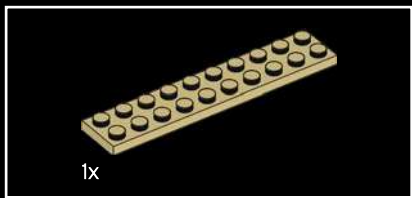

116

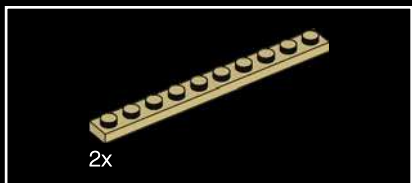
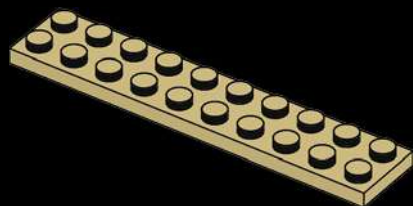

117

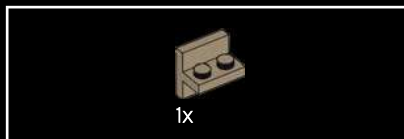
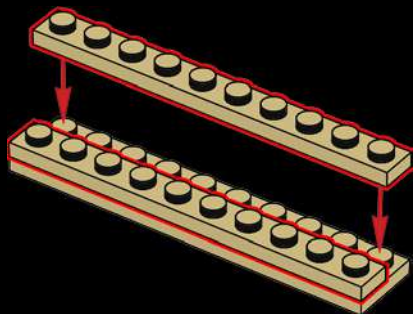

118

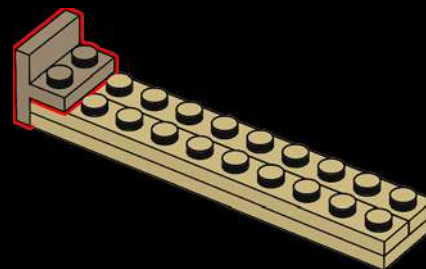

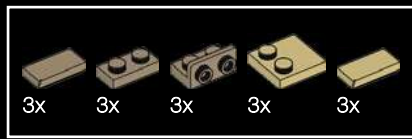

119

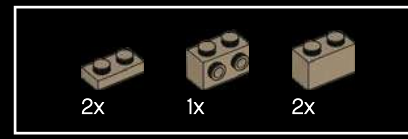
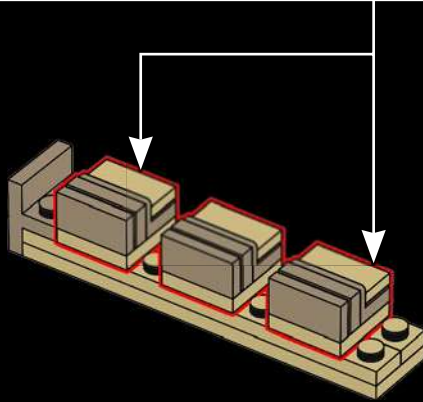
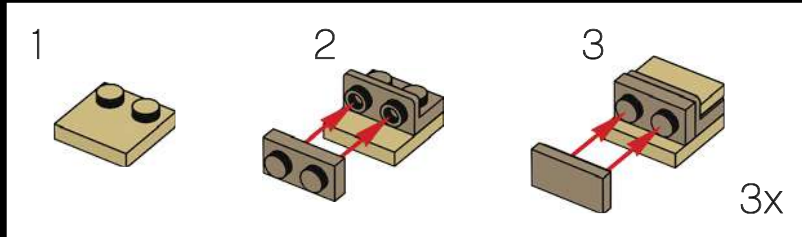

120

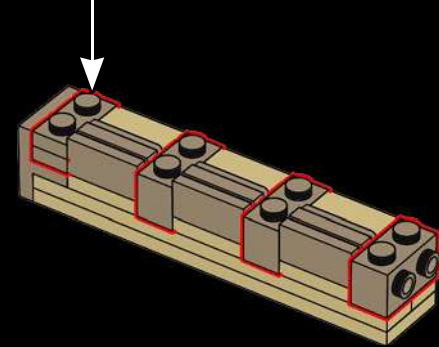
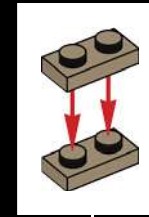

121

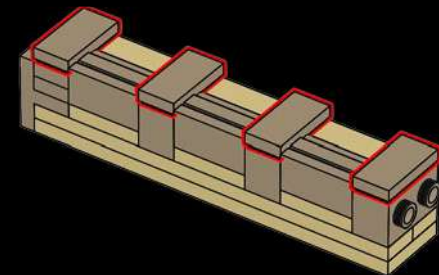

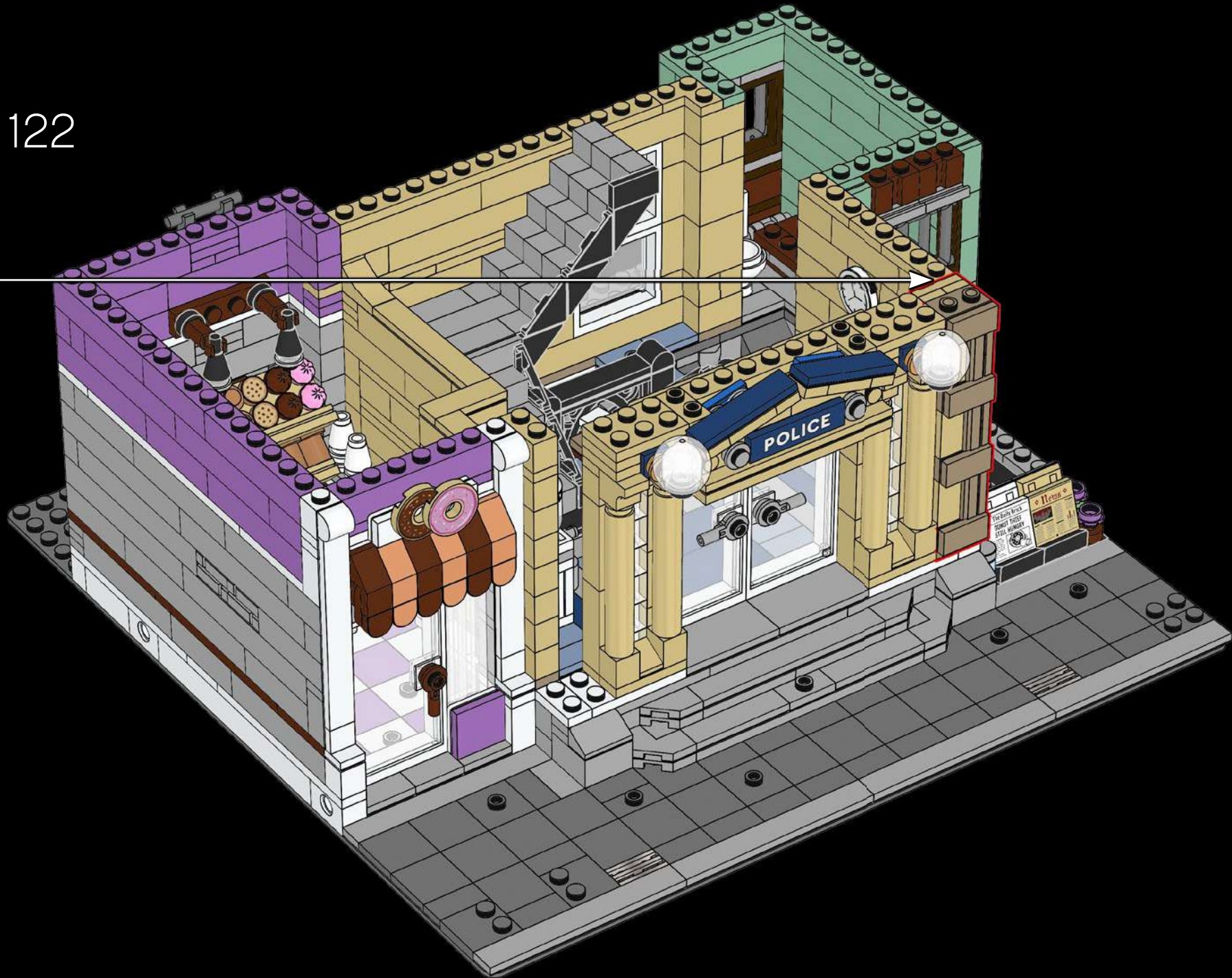

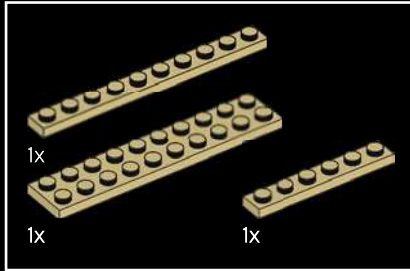
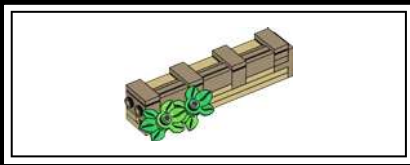

123

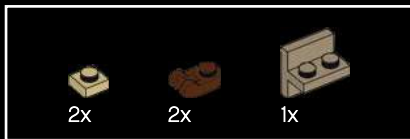
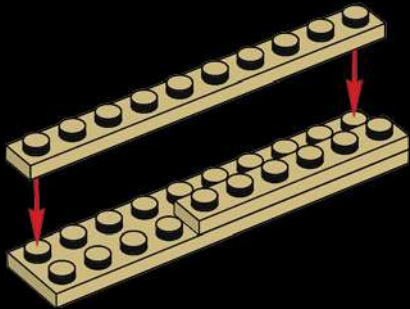

124

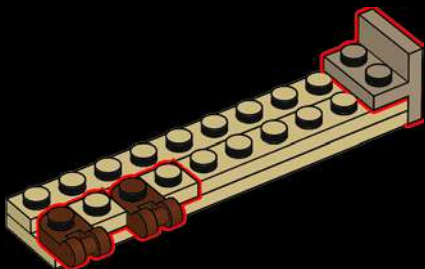

125

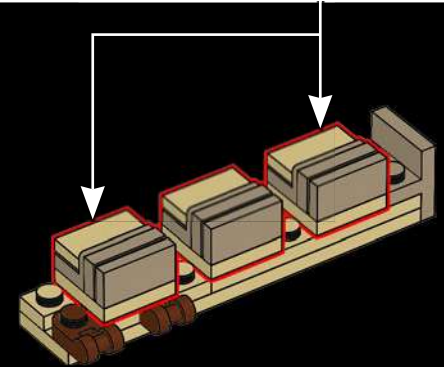
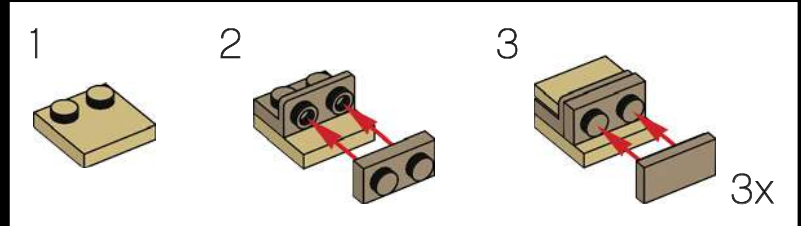

126

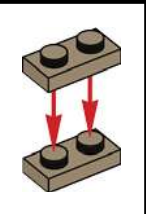
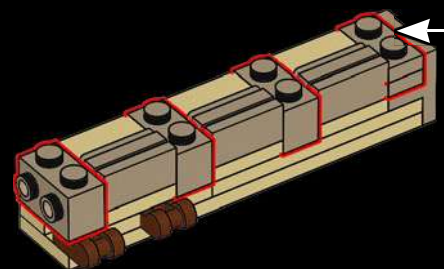



4x

127

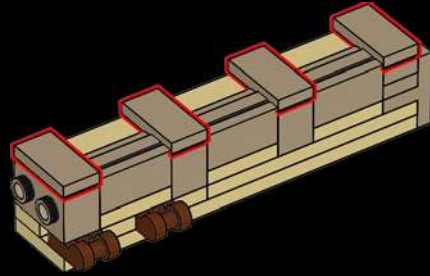

2x

128

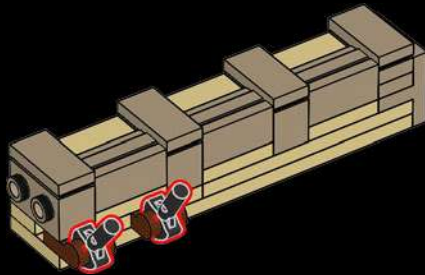

1x



1x

129

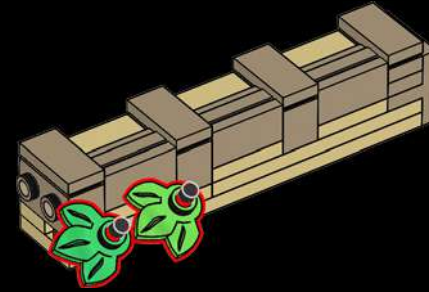

1x



1x

130

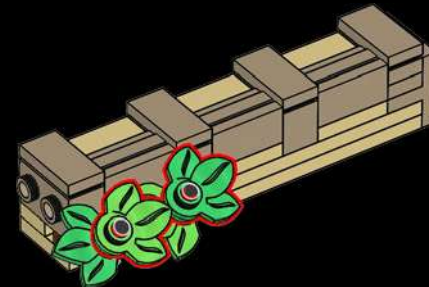



131

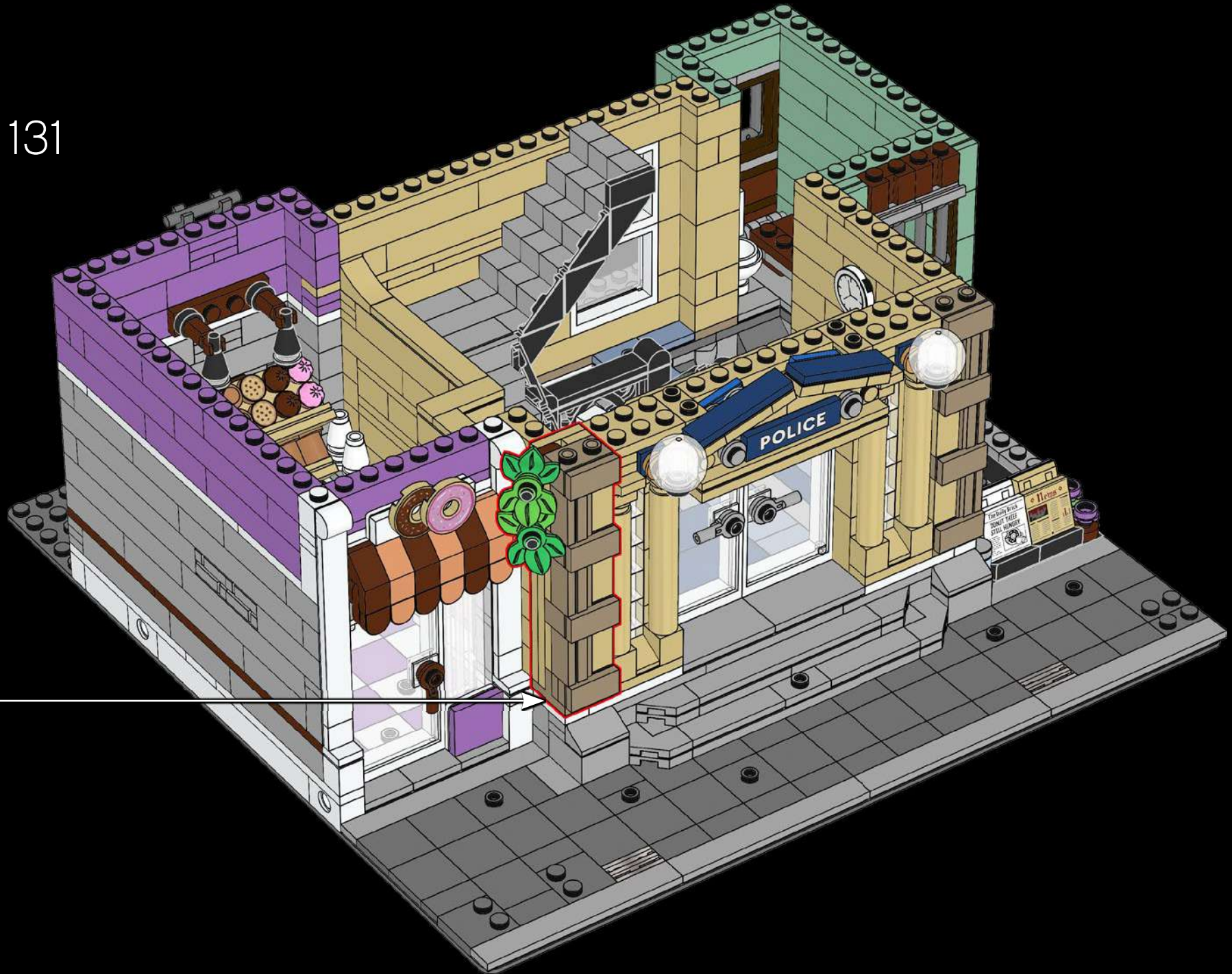

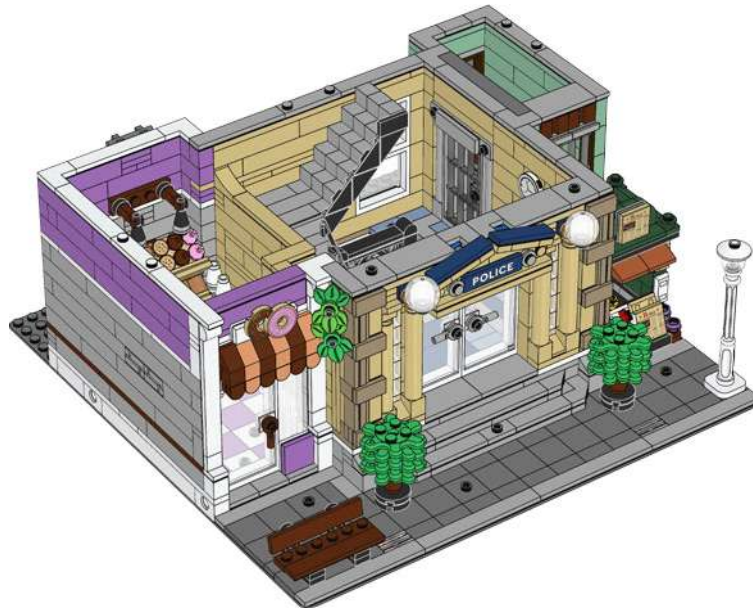

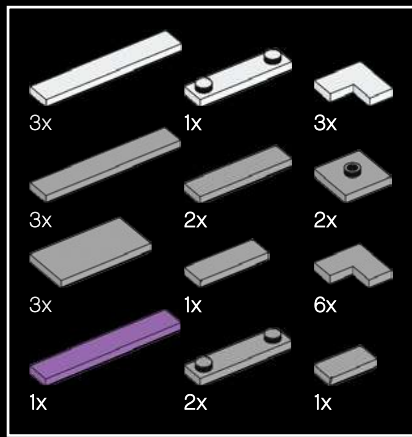

132

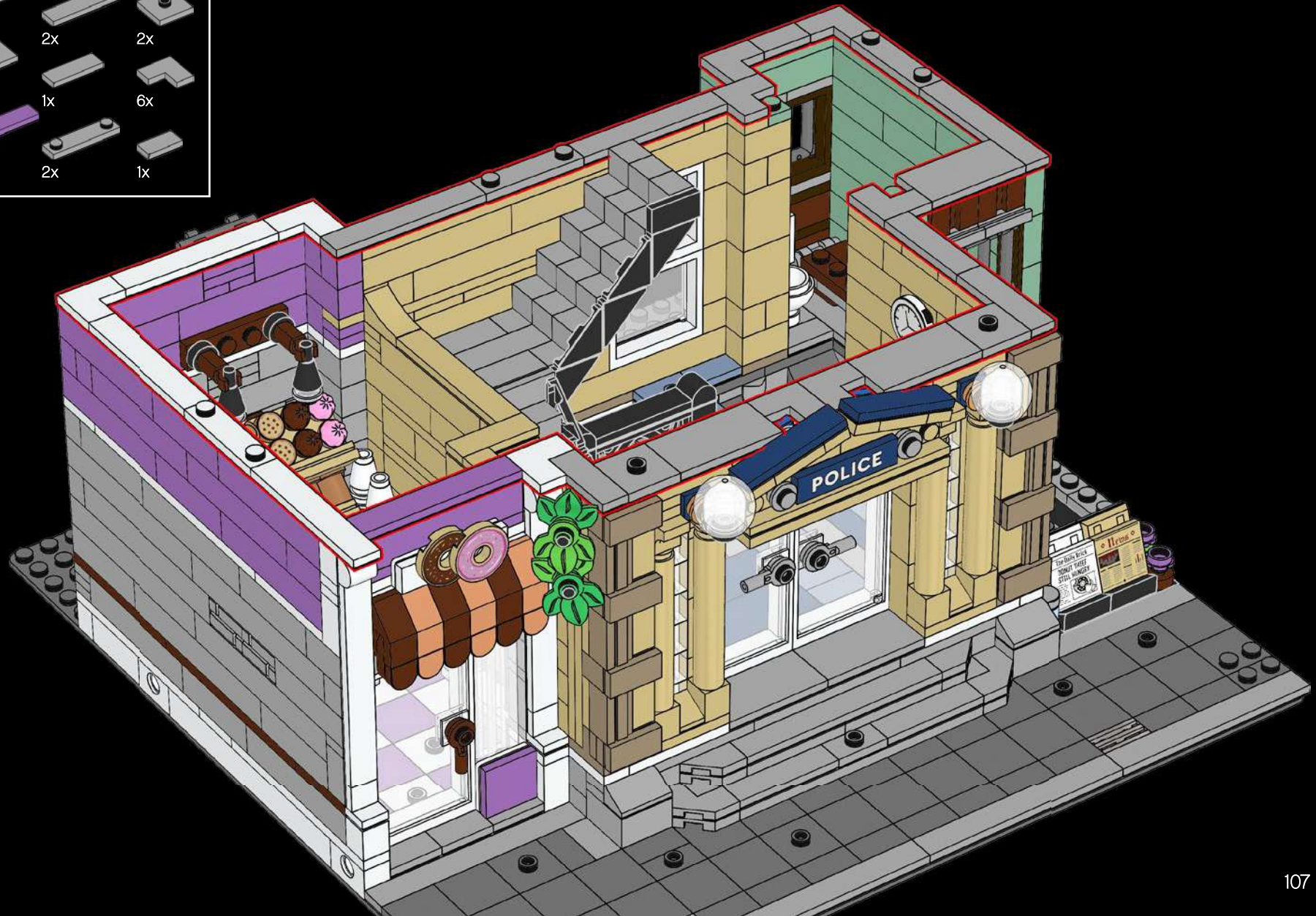

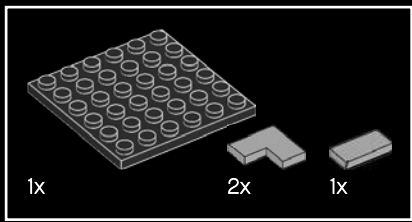

133

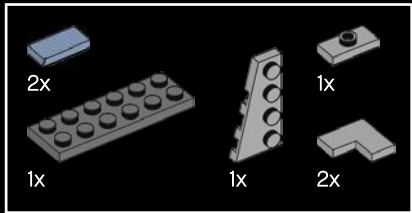
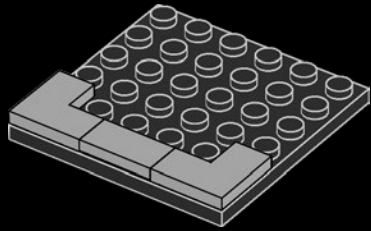

134

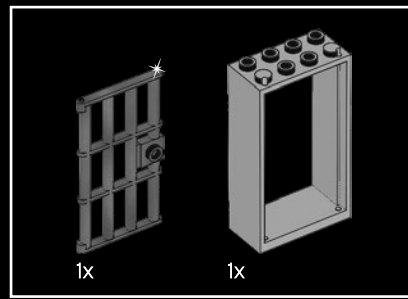
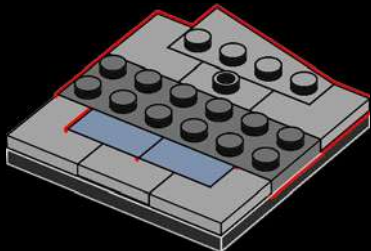

135

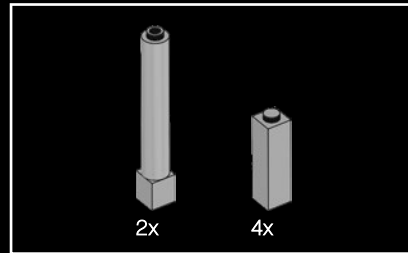
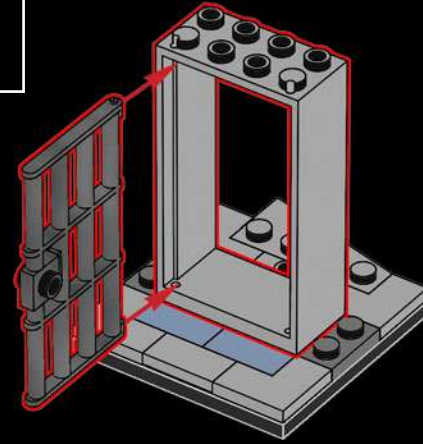

136

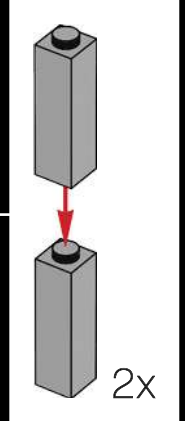
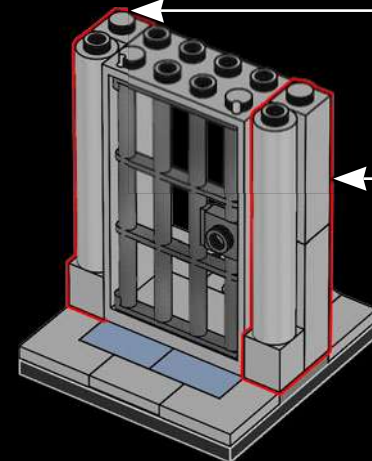

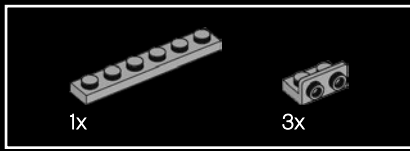

137

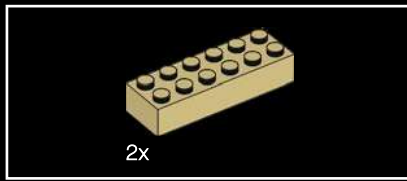
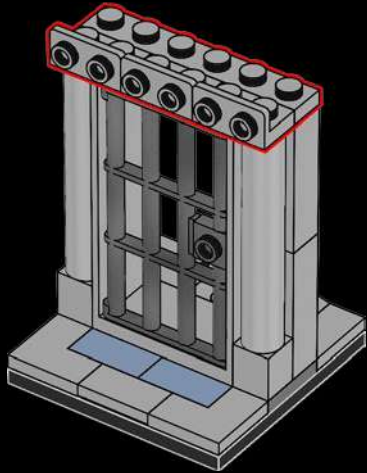

138

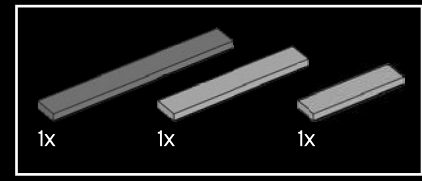
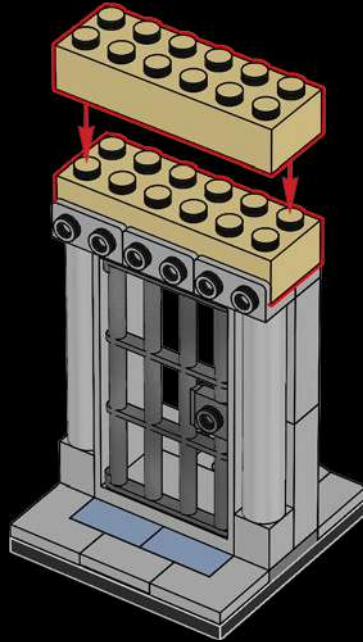

139

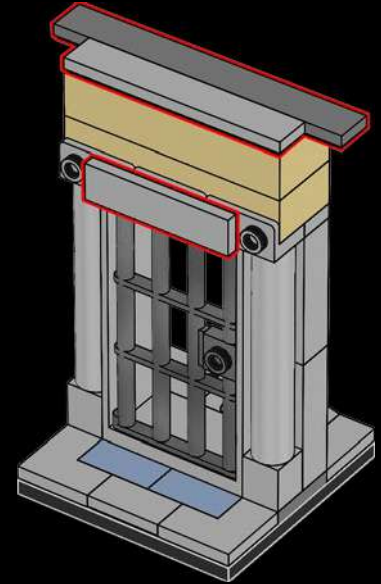

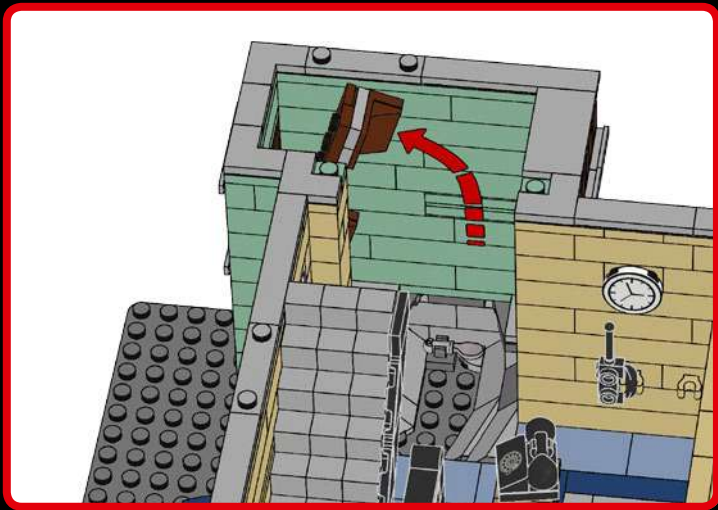

140



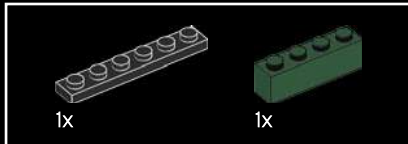
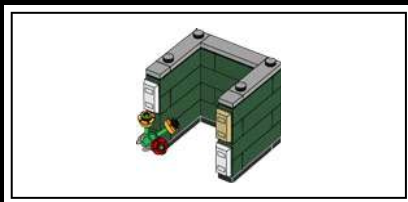

141

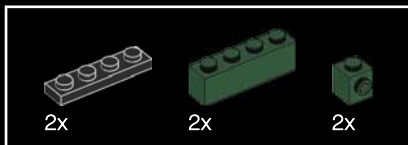
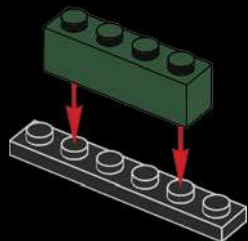

142

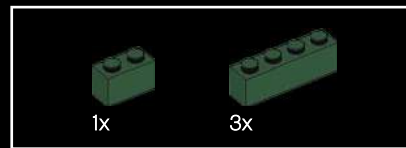
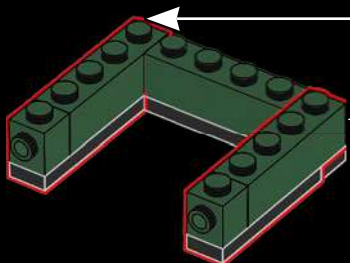
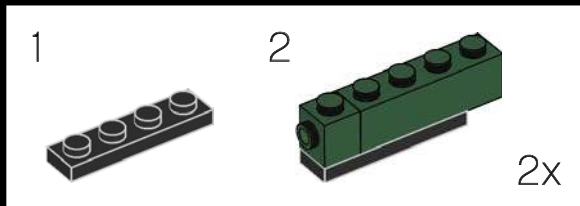

143

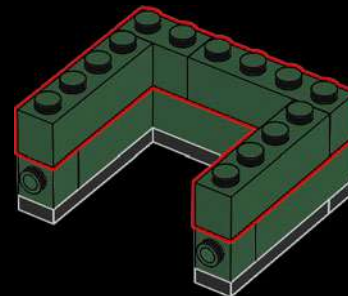

144

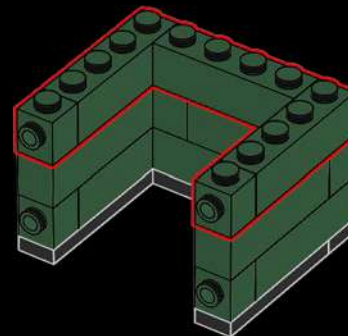

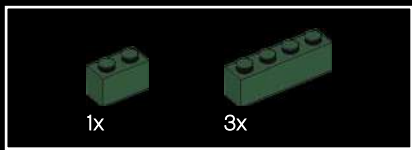

145

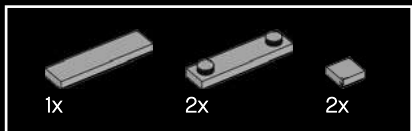
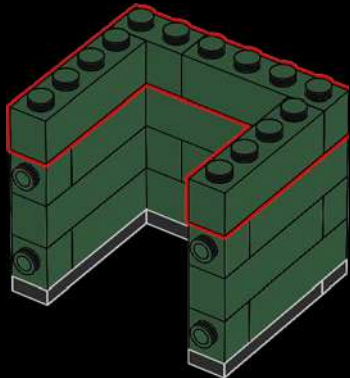

146

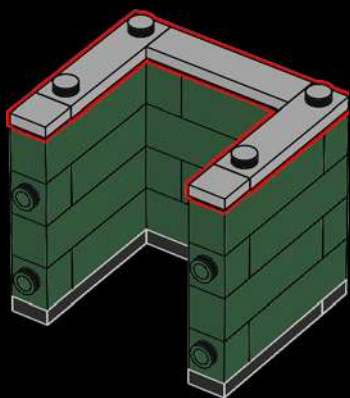

147

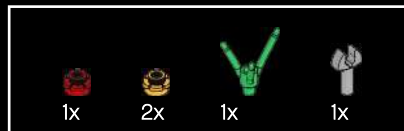
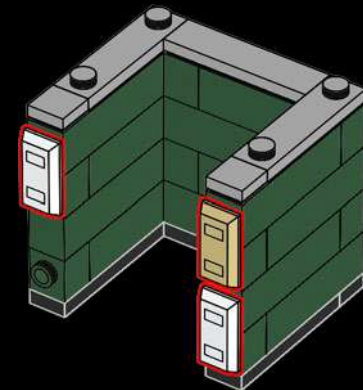

148

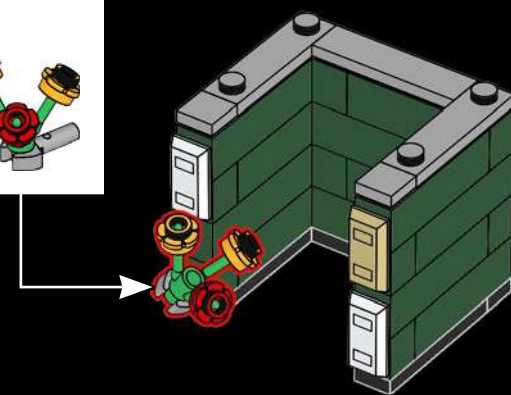
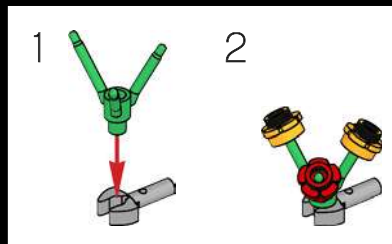



149



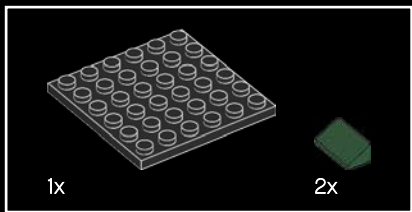

150

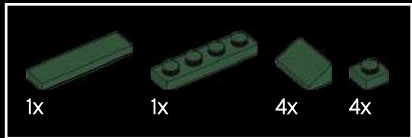
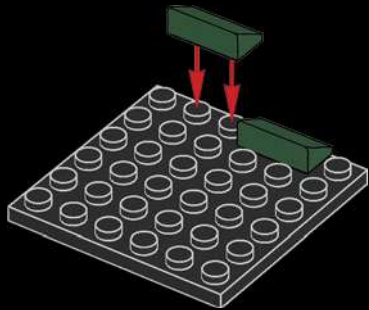

151

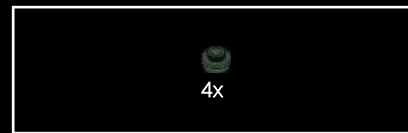
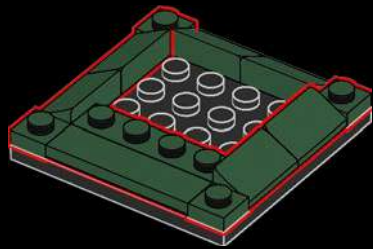

152

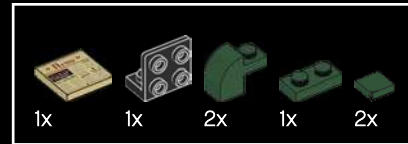
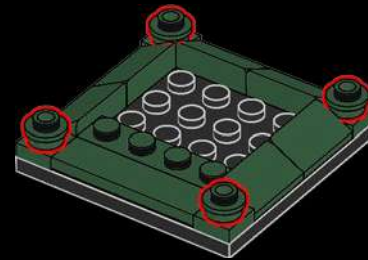

153

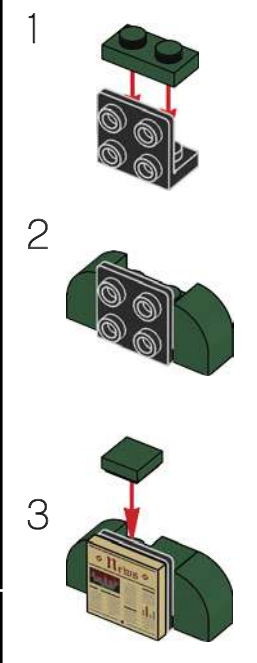
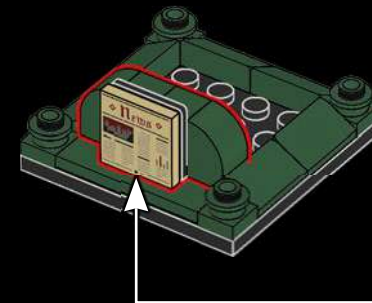

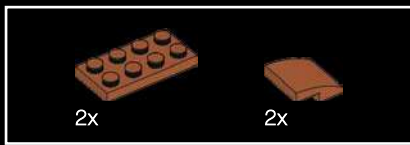

154

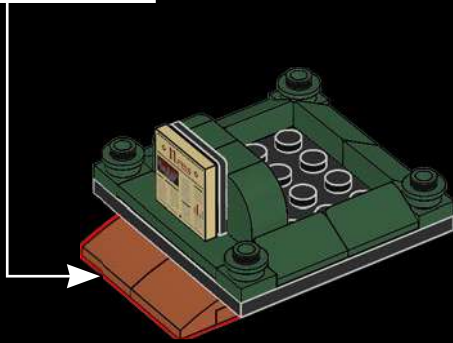
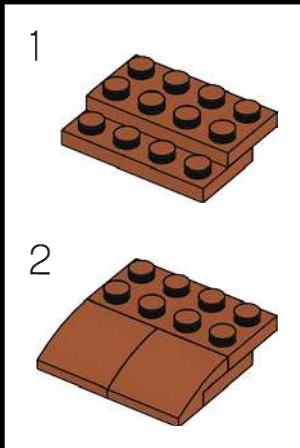

155





156

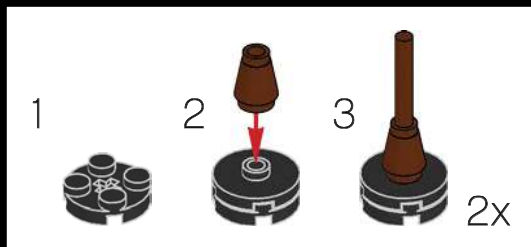

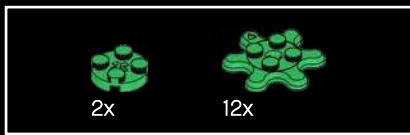

157

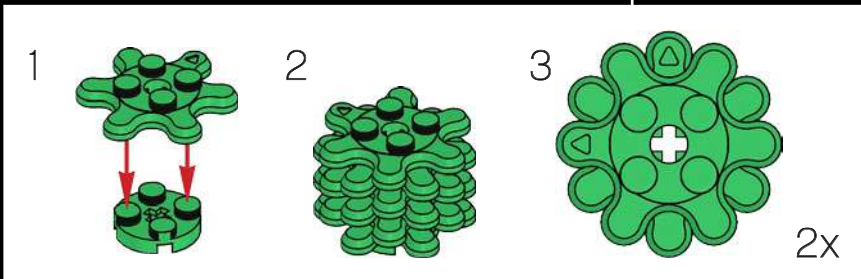

These convincing brick-built trees were created with new gear parts!



158

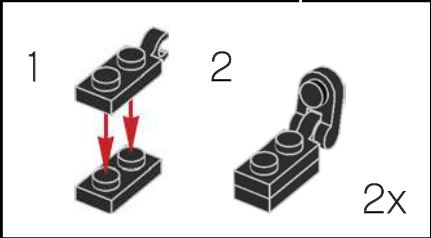

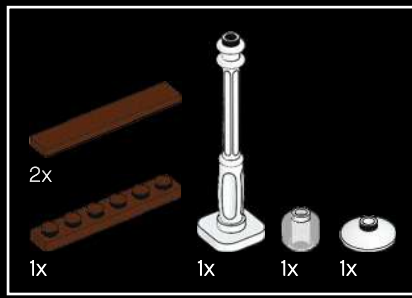

159

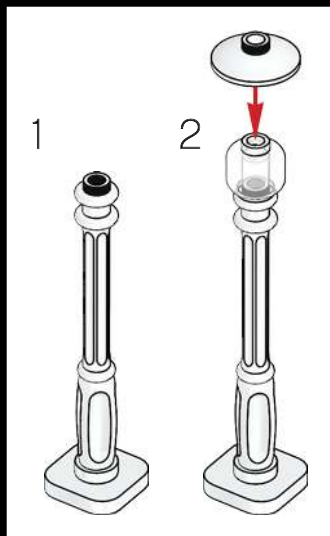

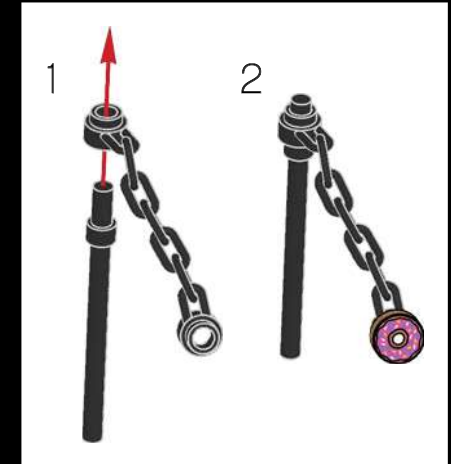
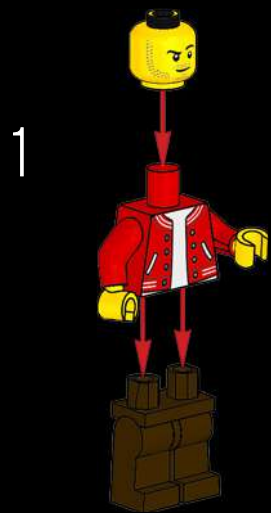
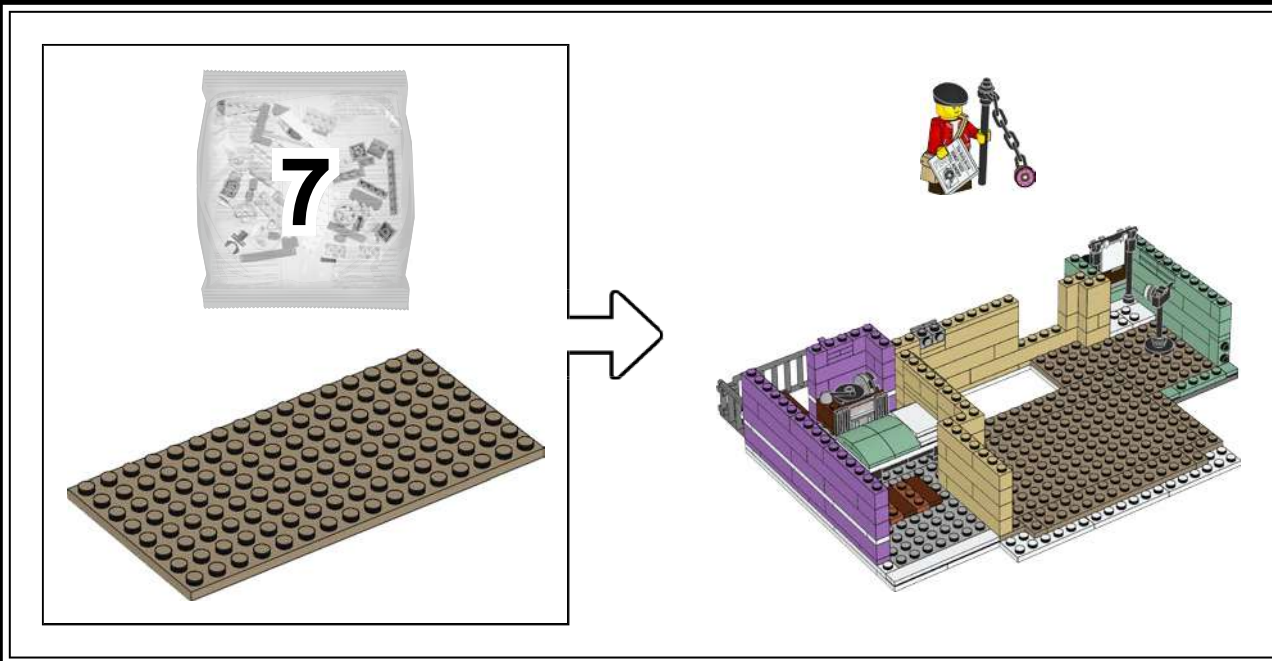



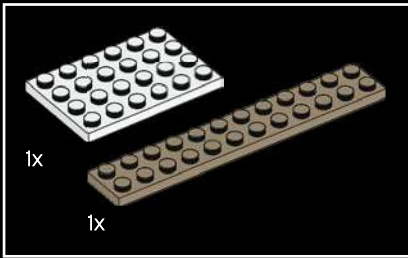

160

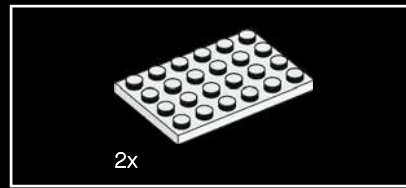
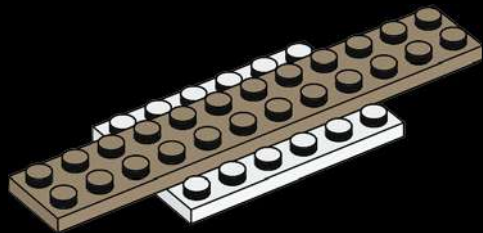

161

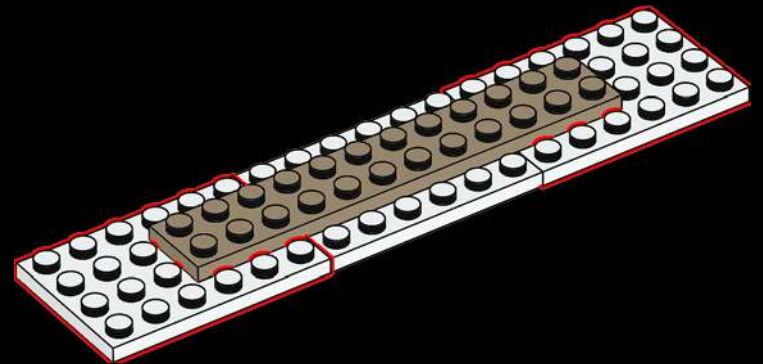

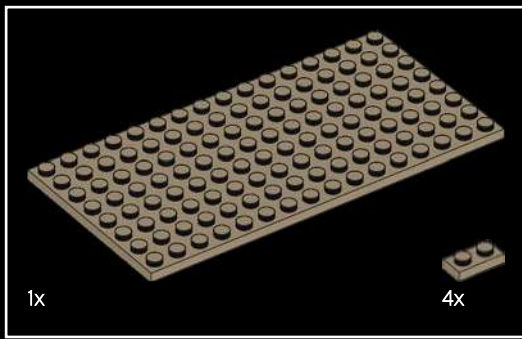

162

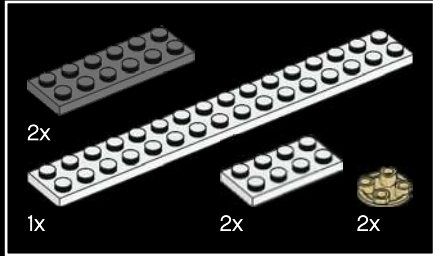
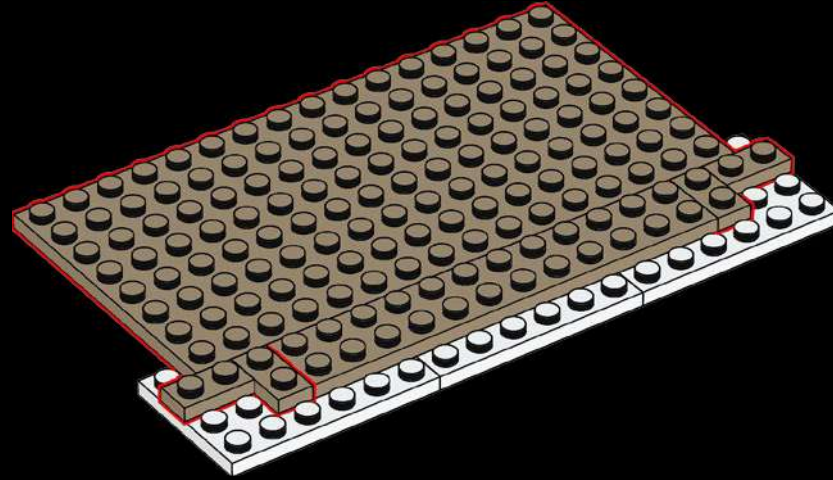

163

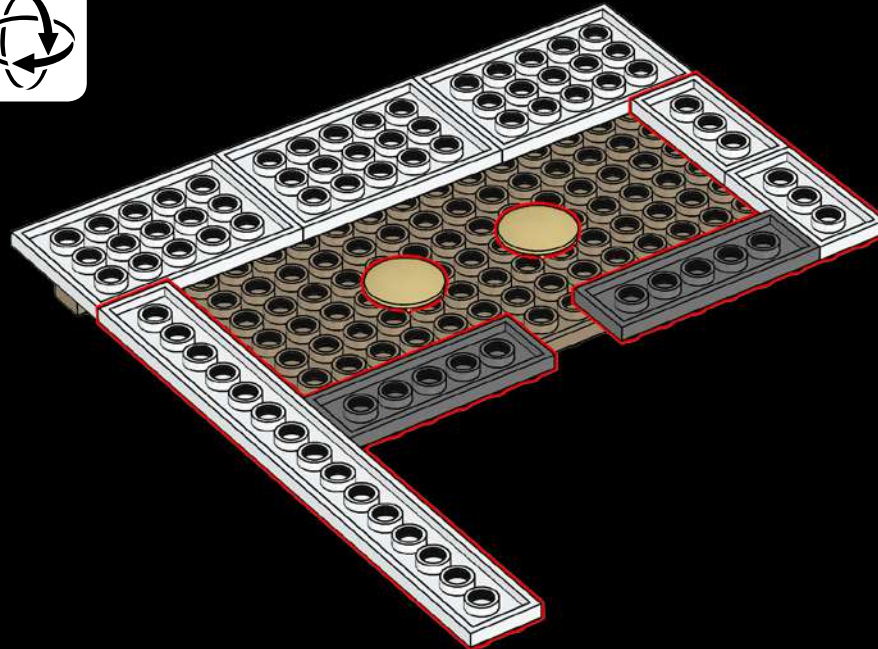

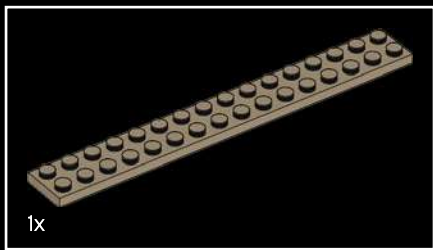

1x

164

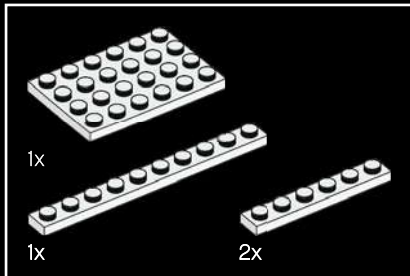
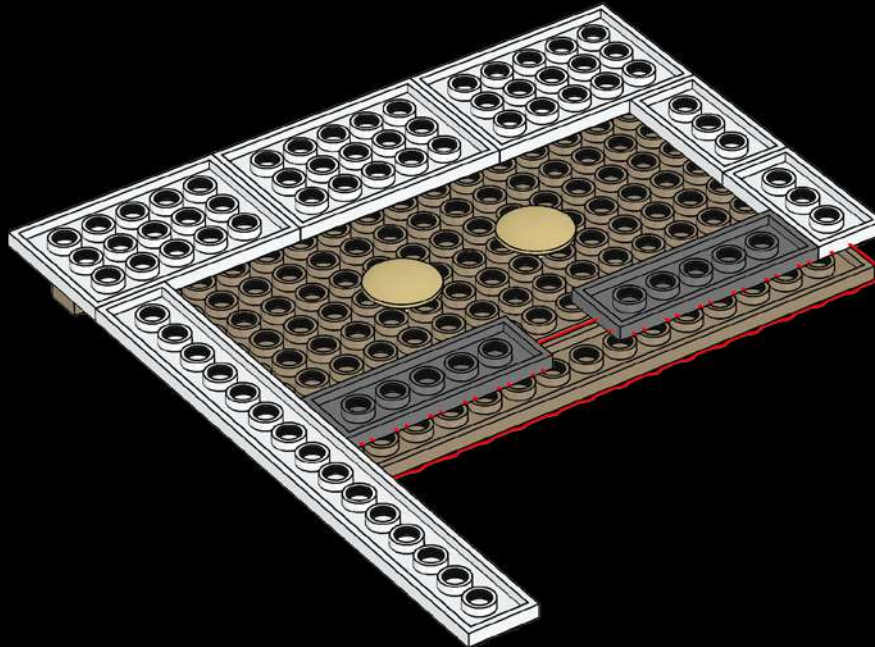

1x

1x

2x

165

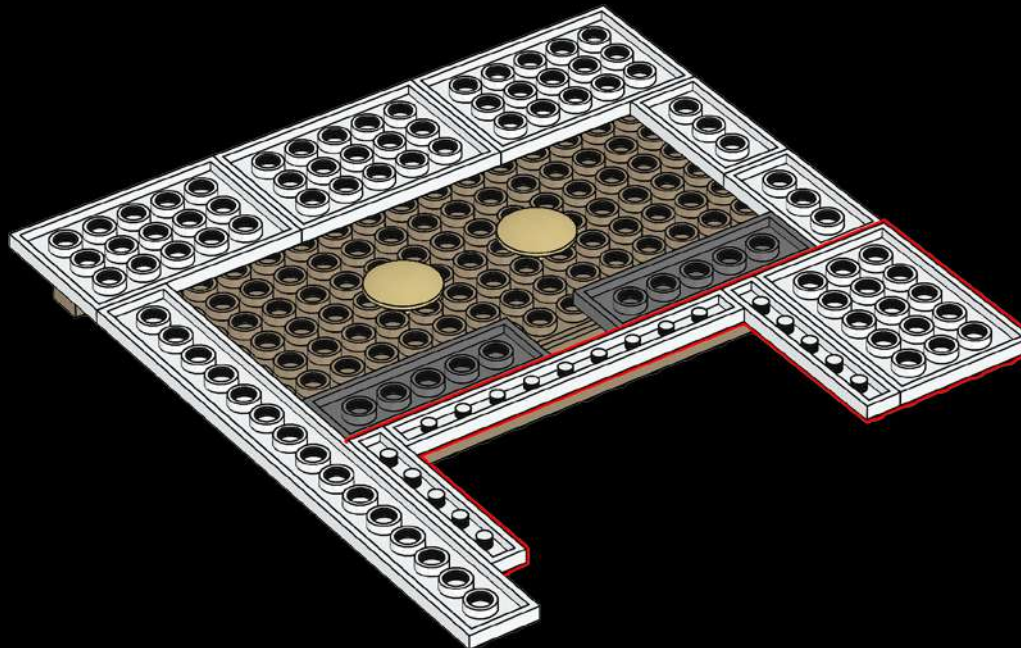

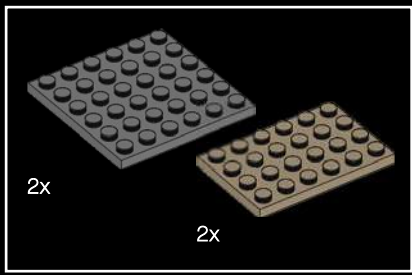

166

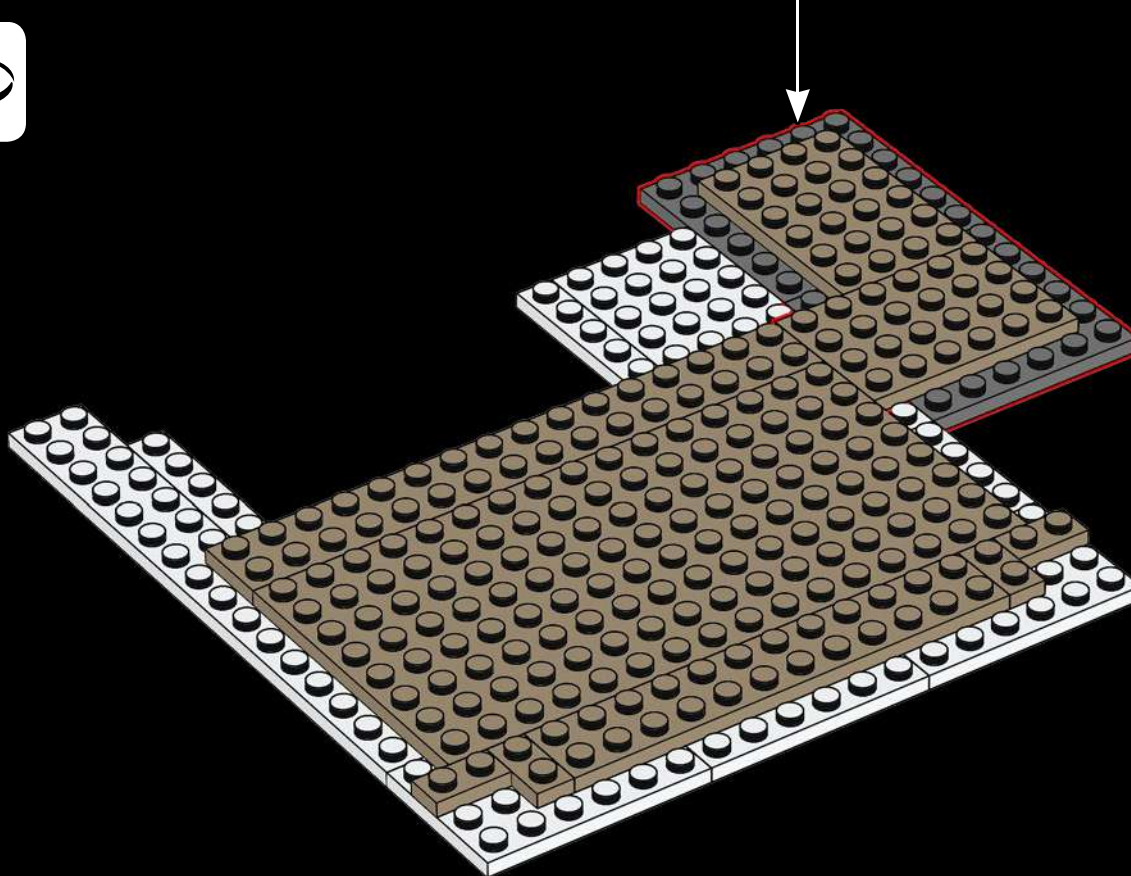
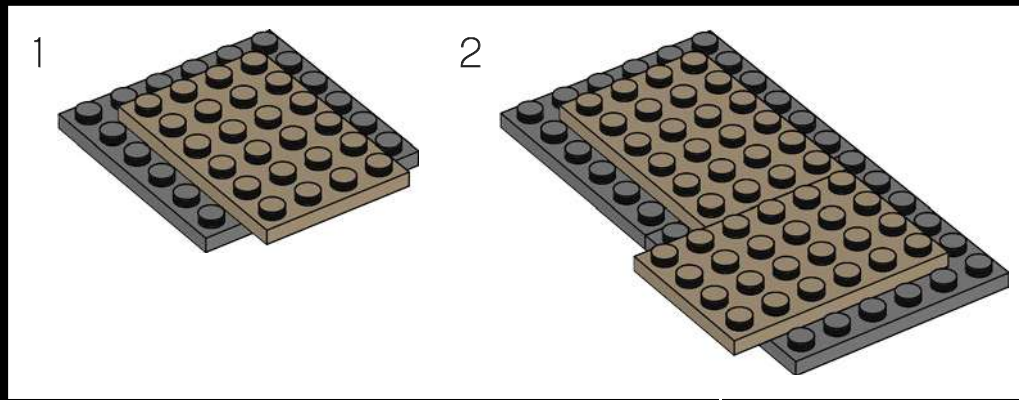

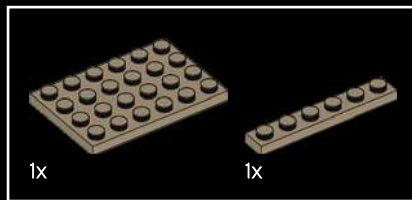

167

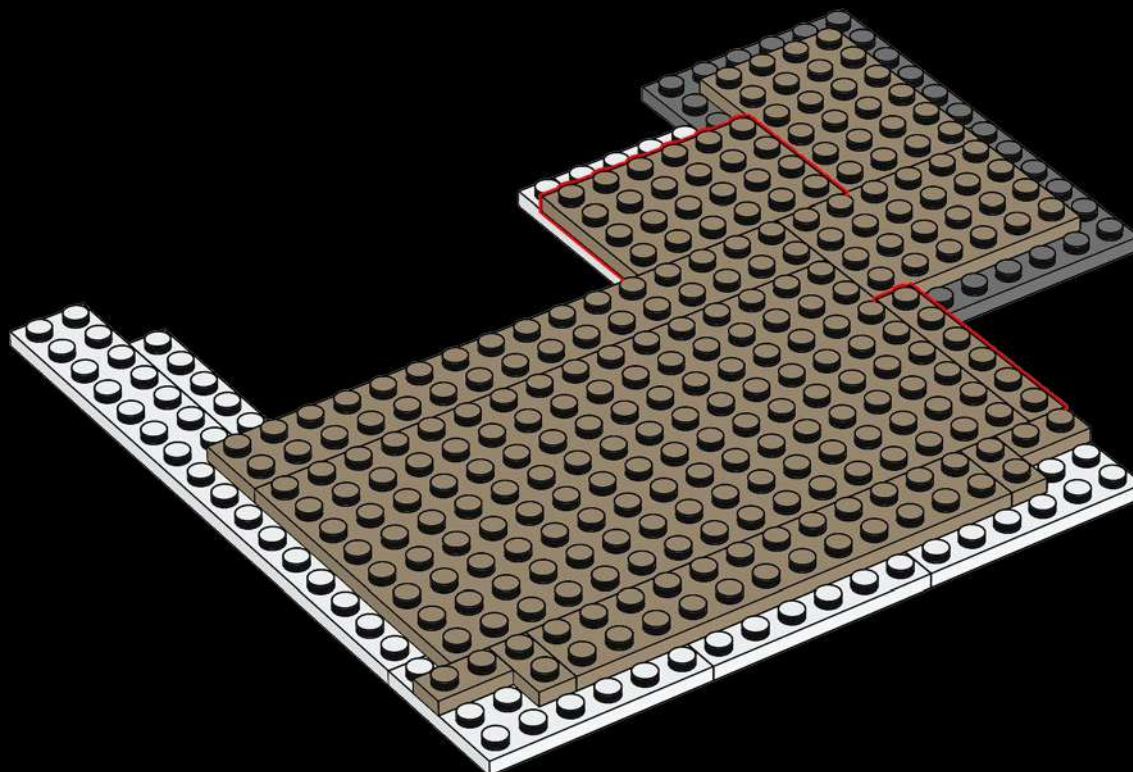

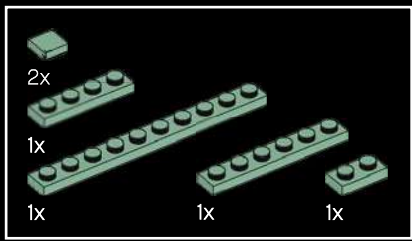

168

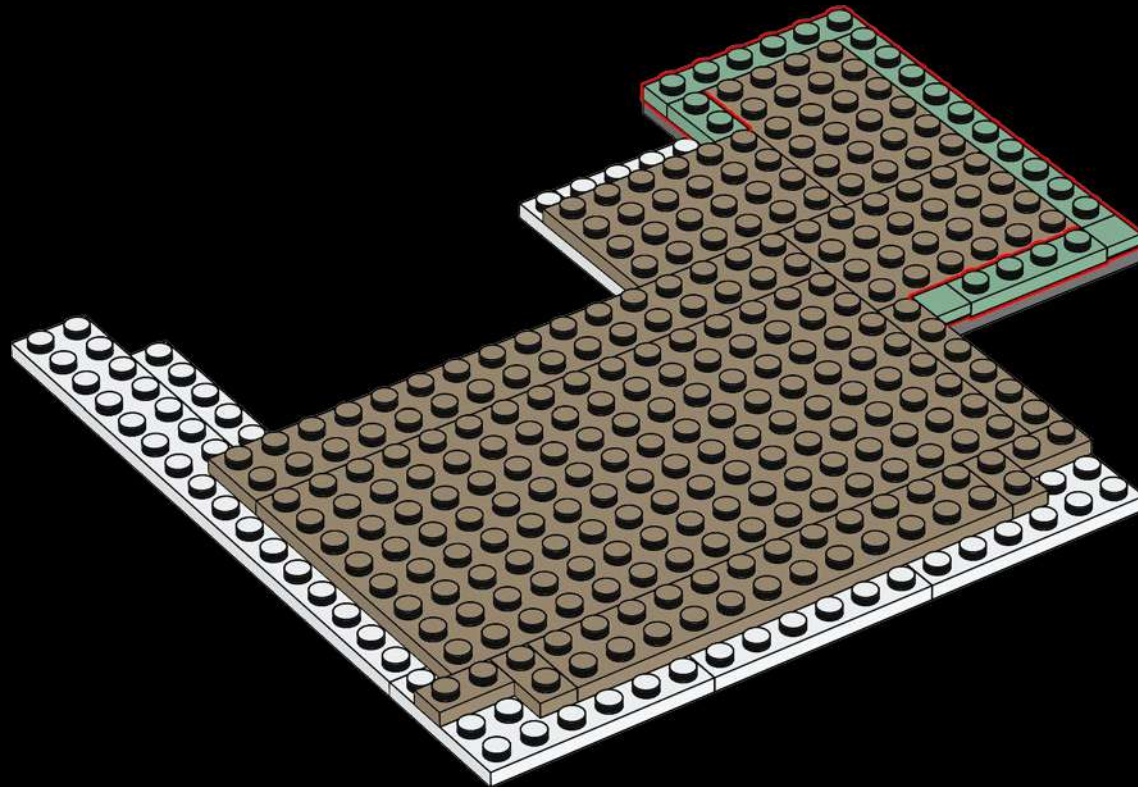

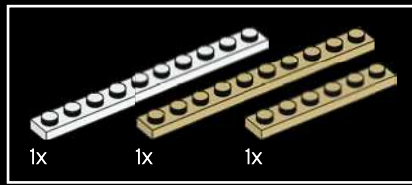

169

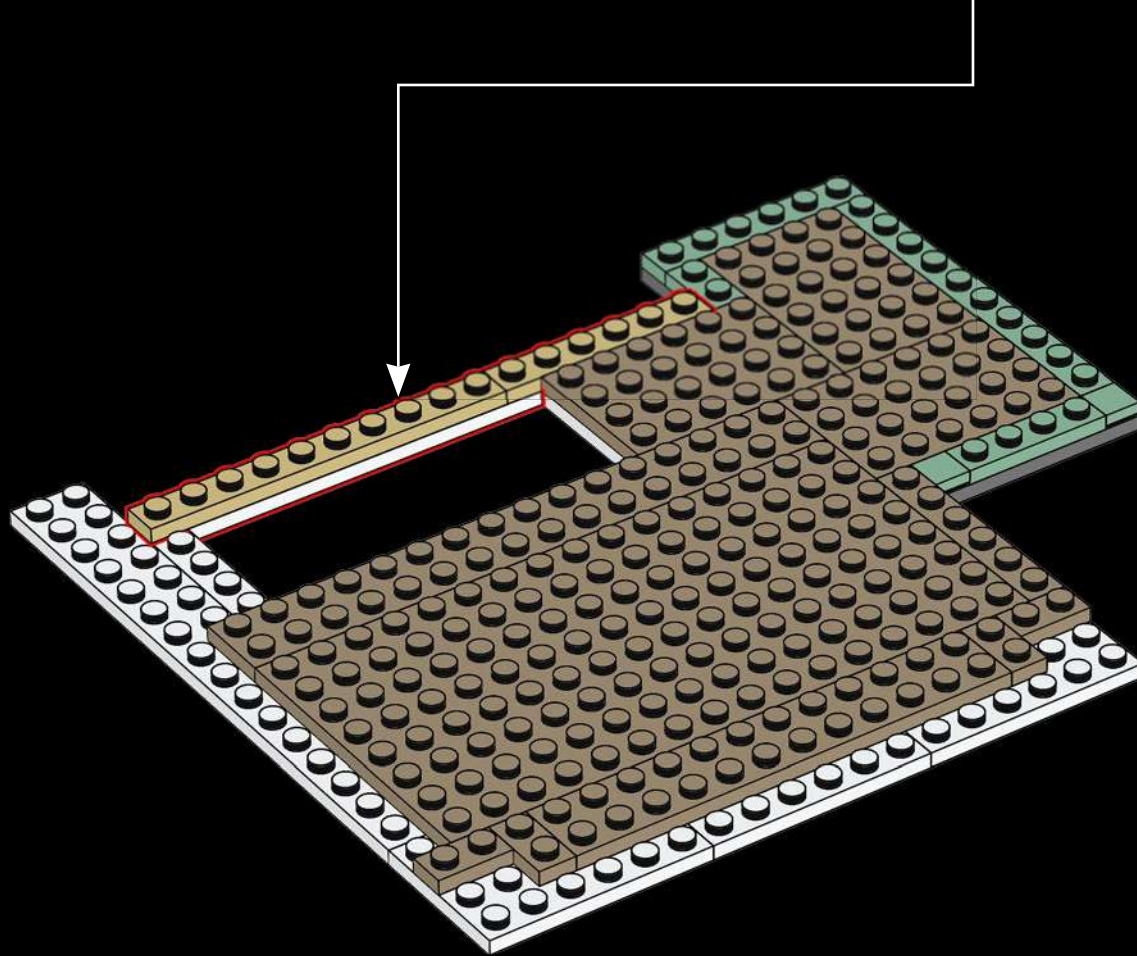
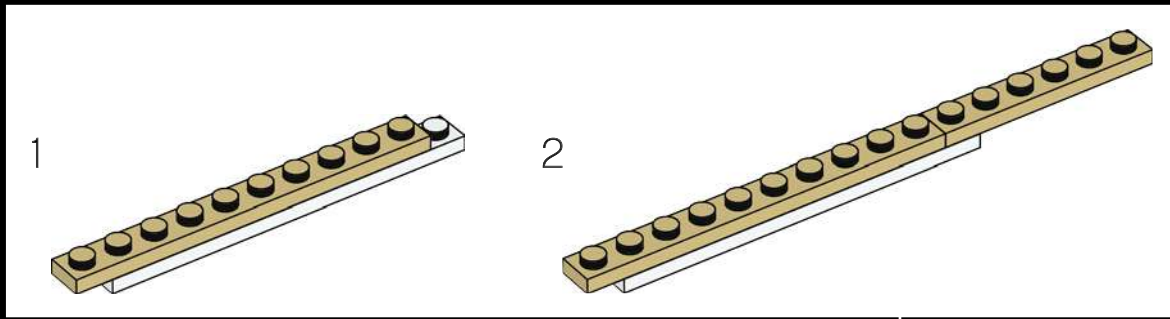

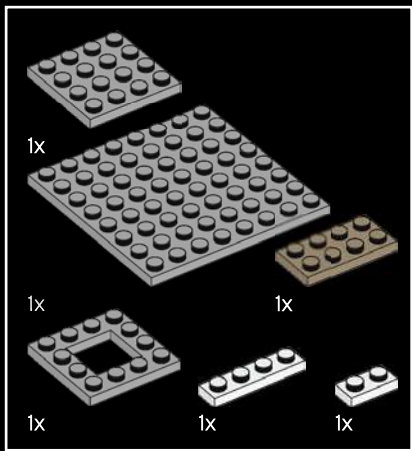

170

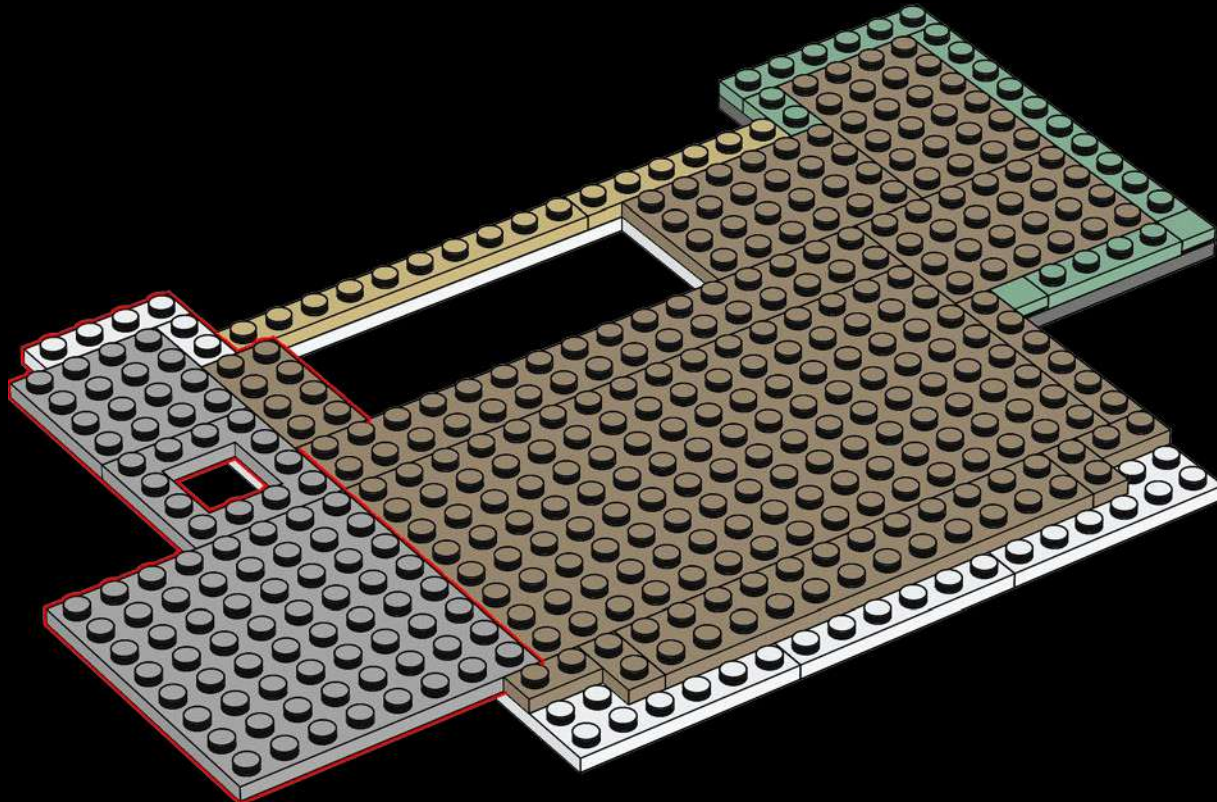



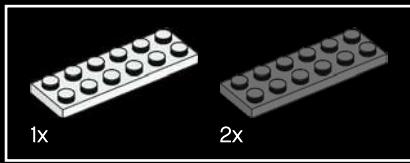

171

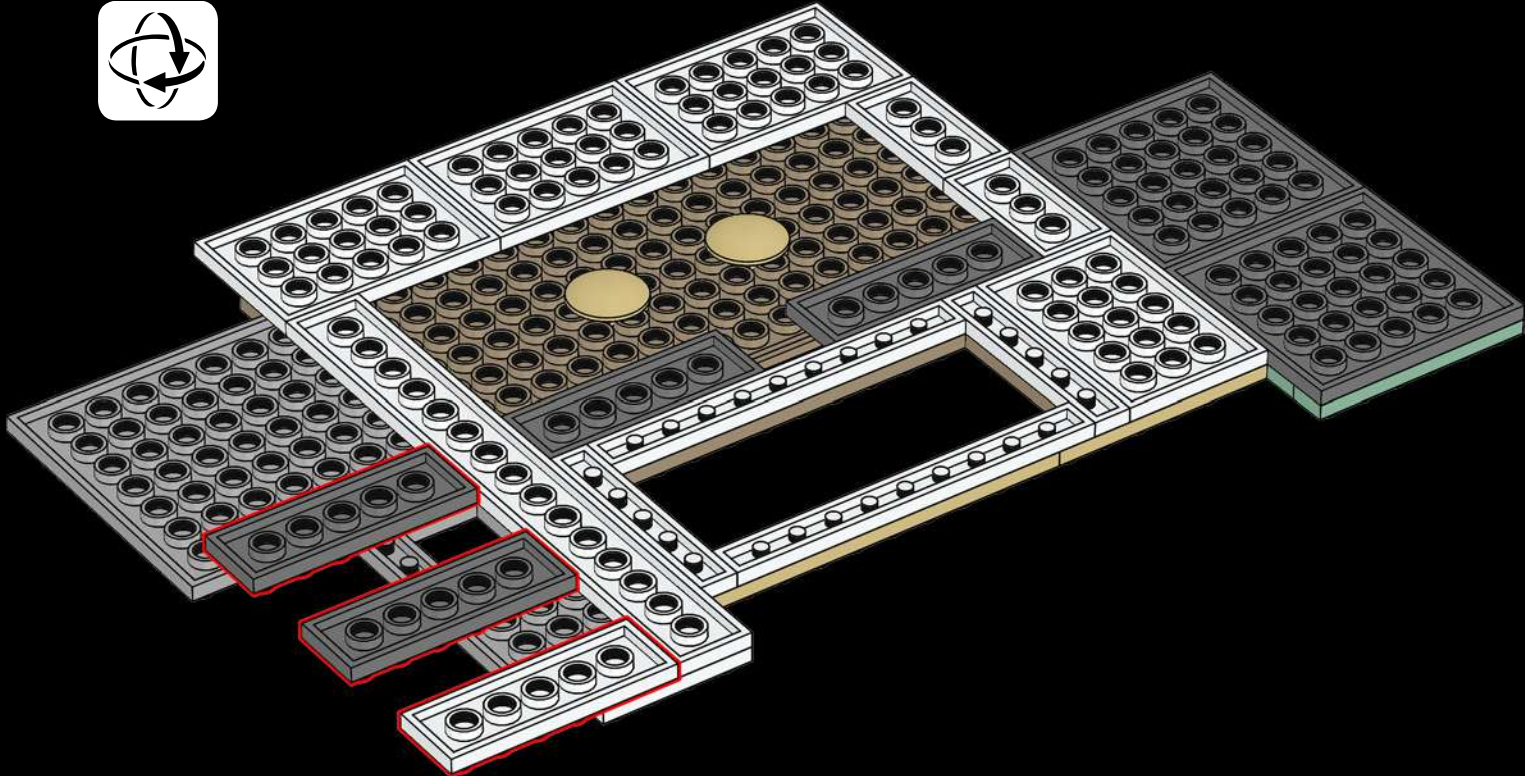

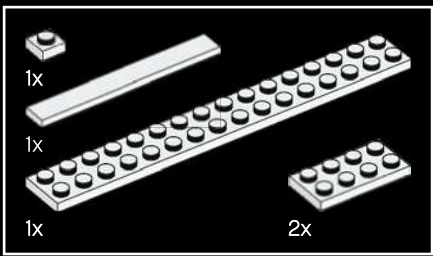

172

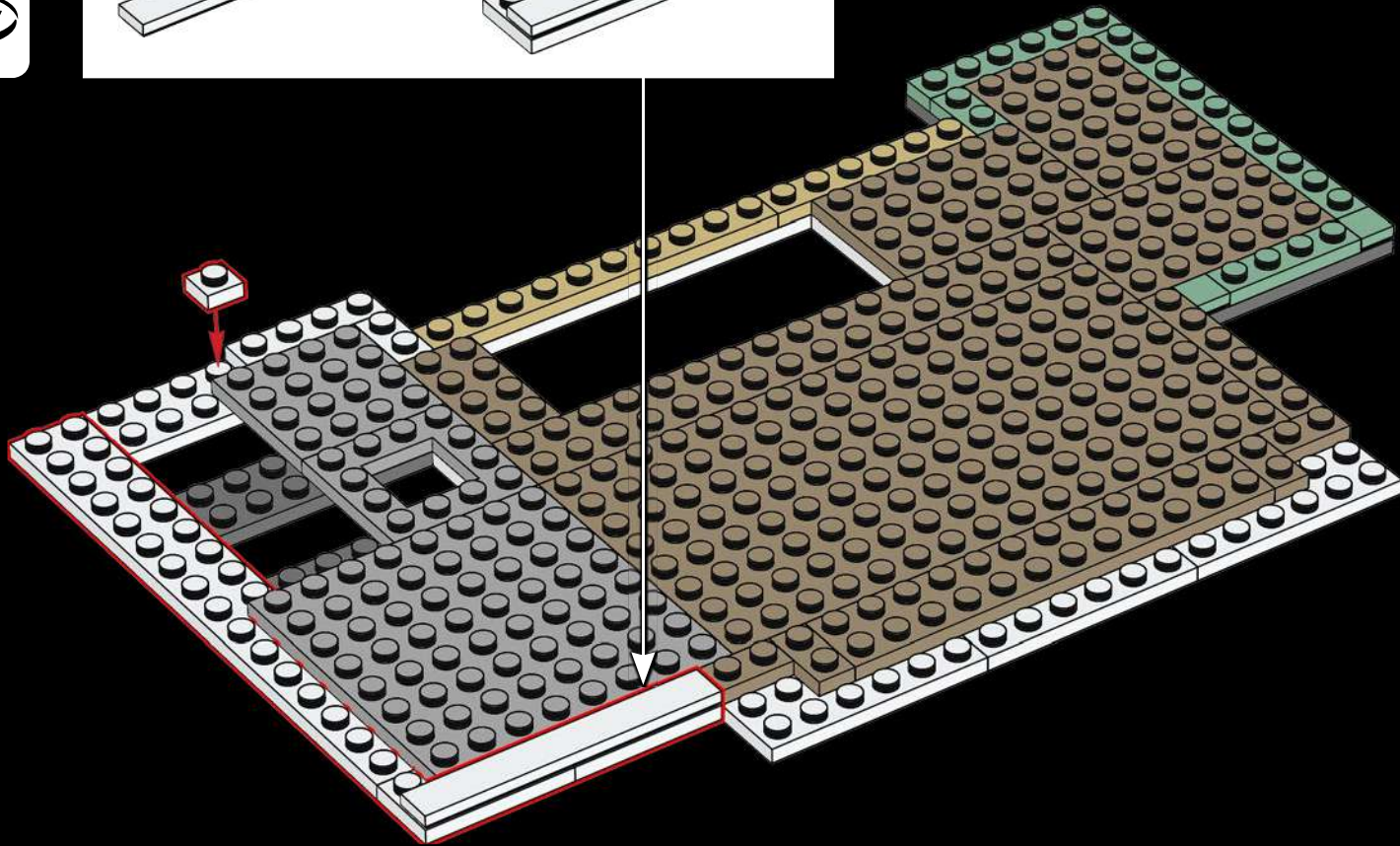
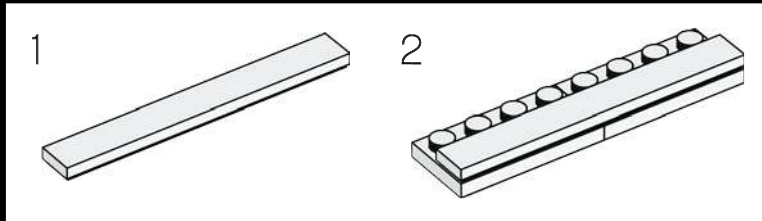

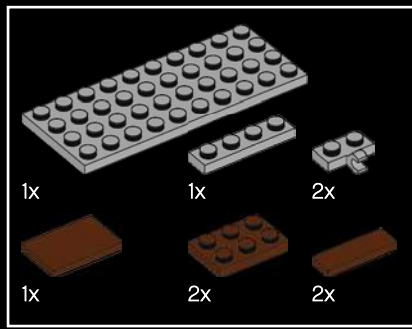

173

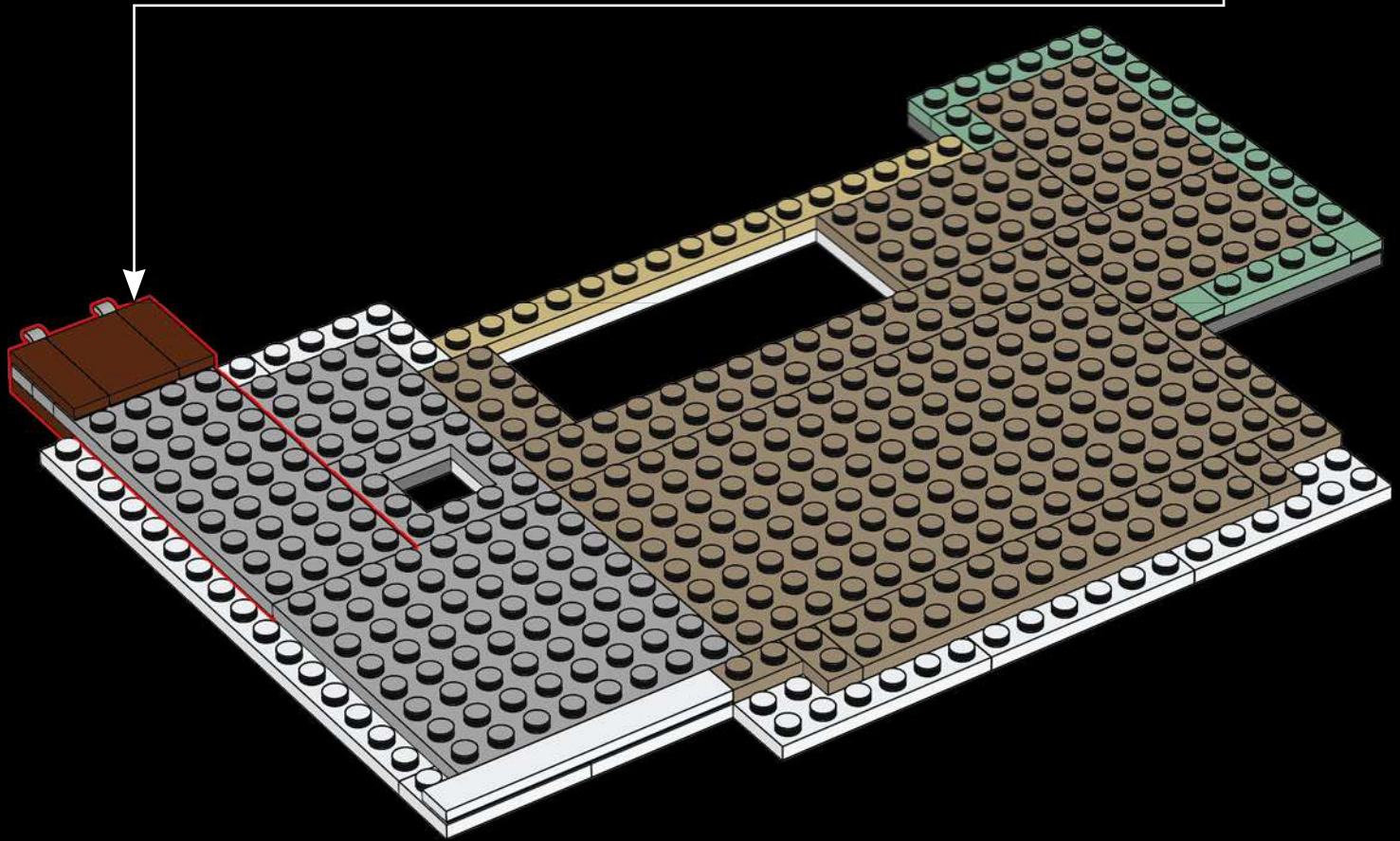
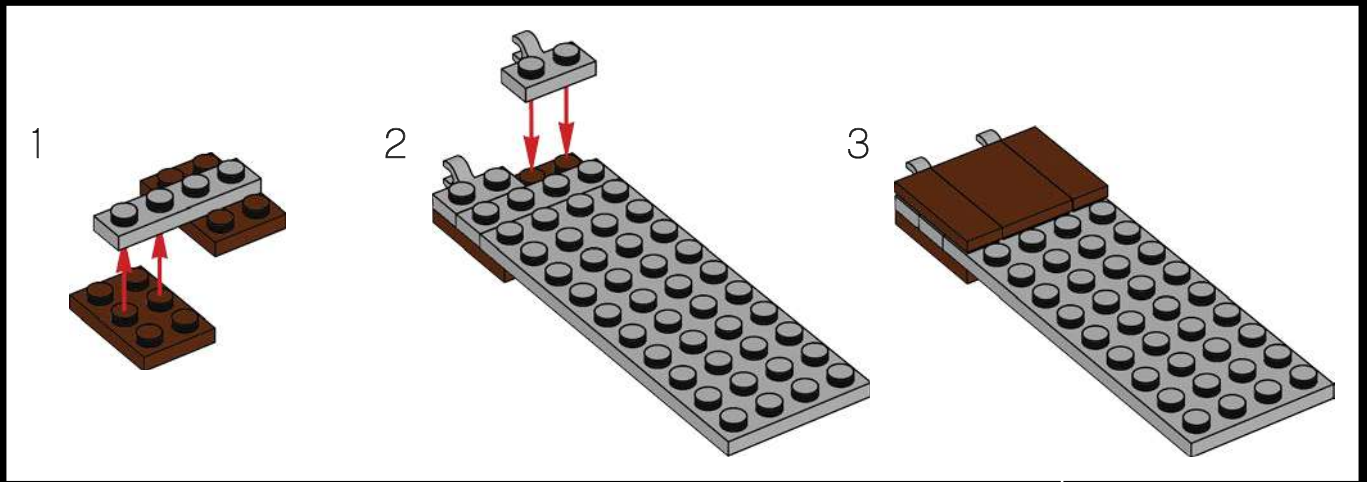

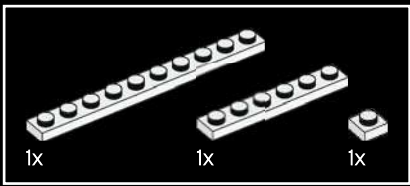

174

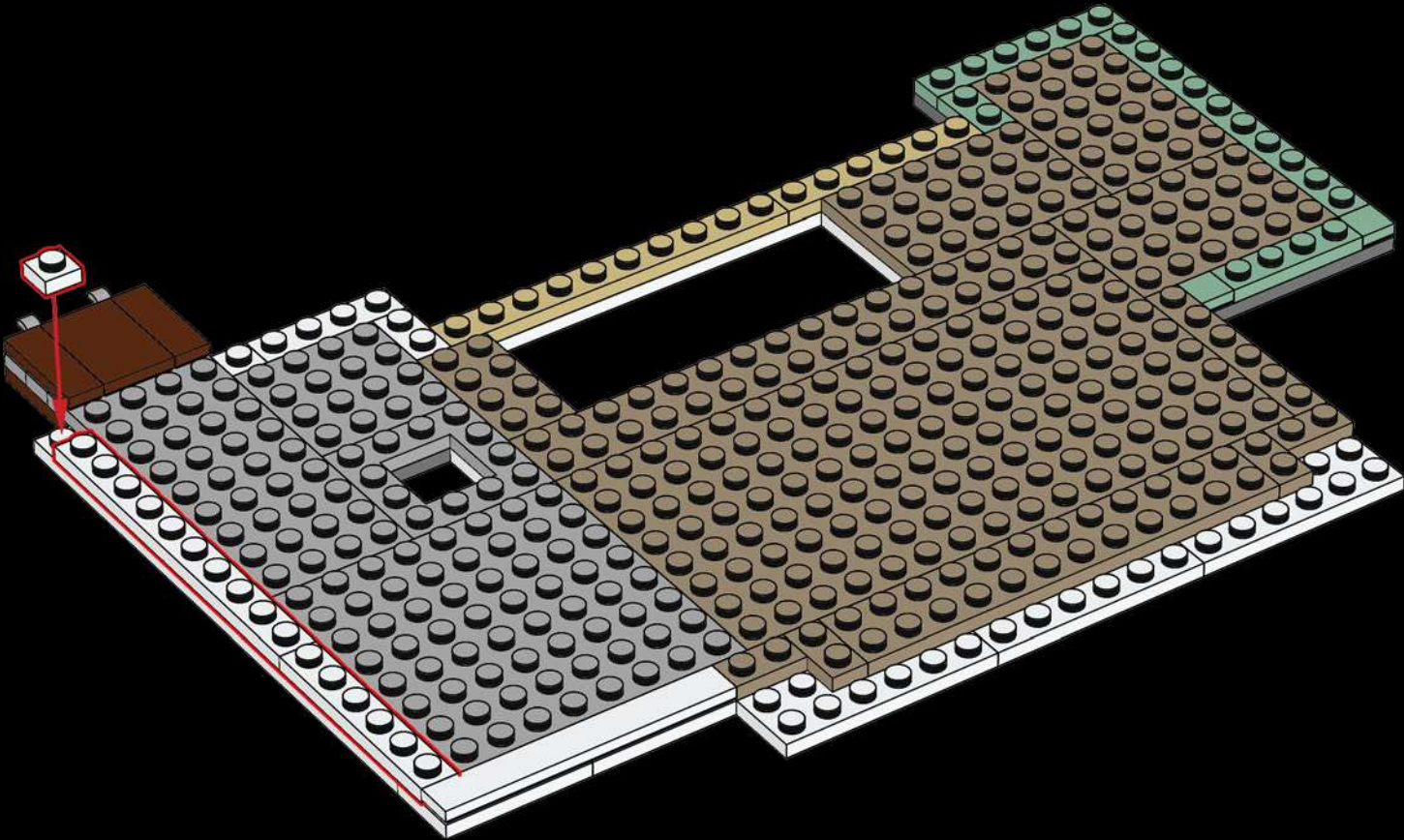

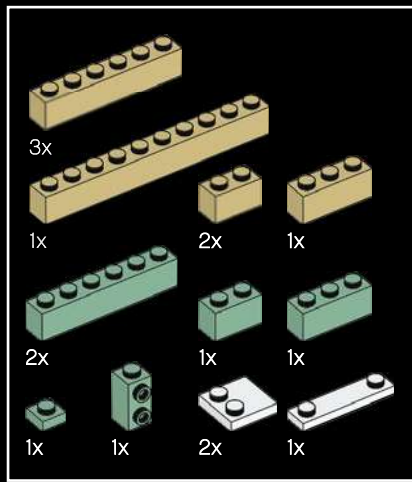

175

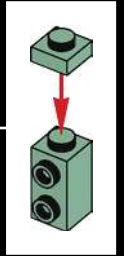
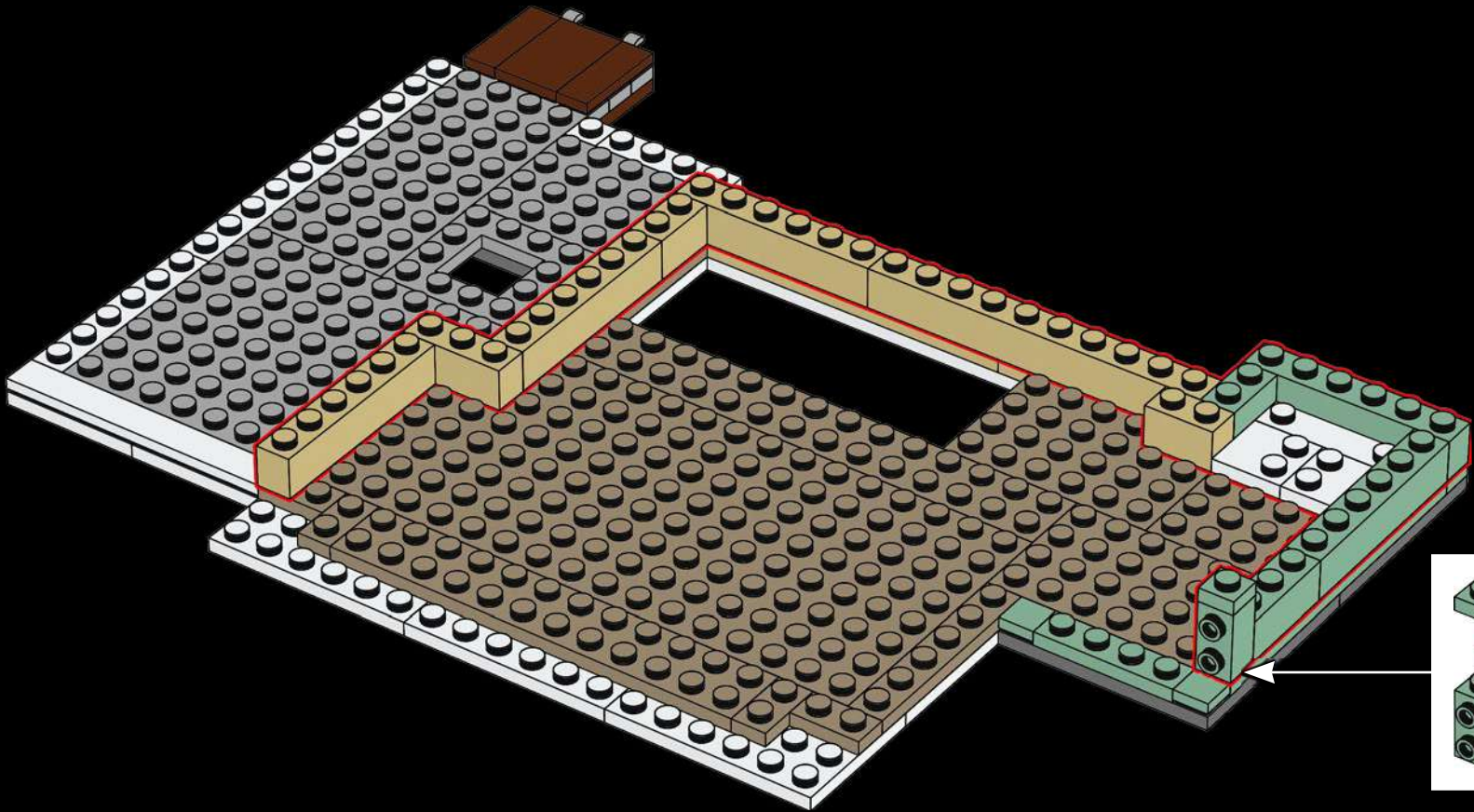

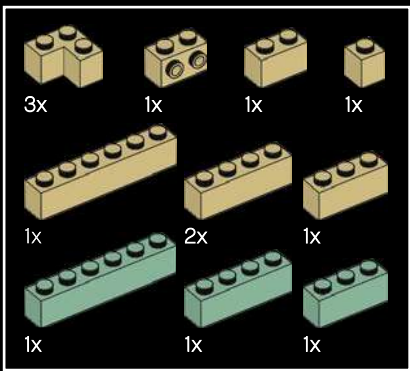

176

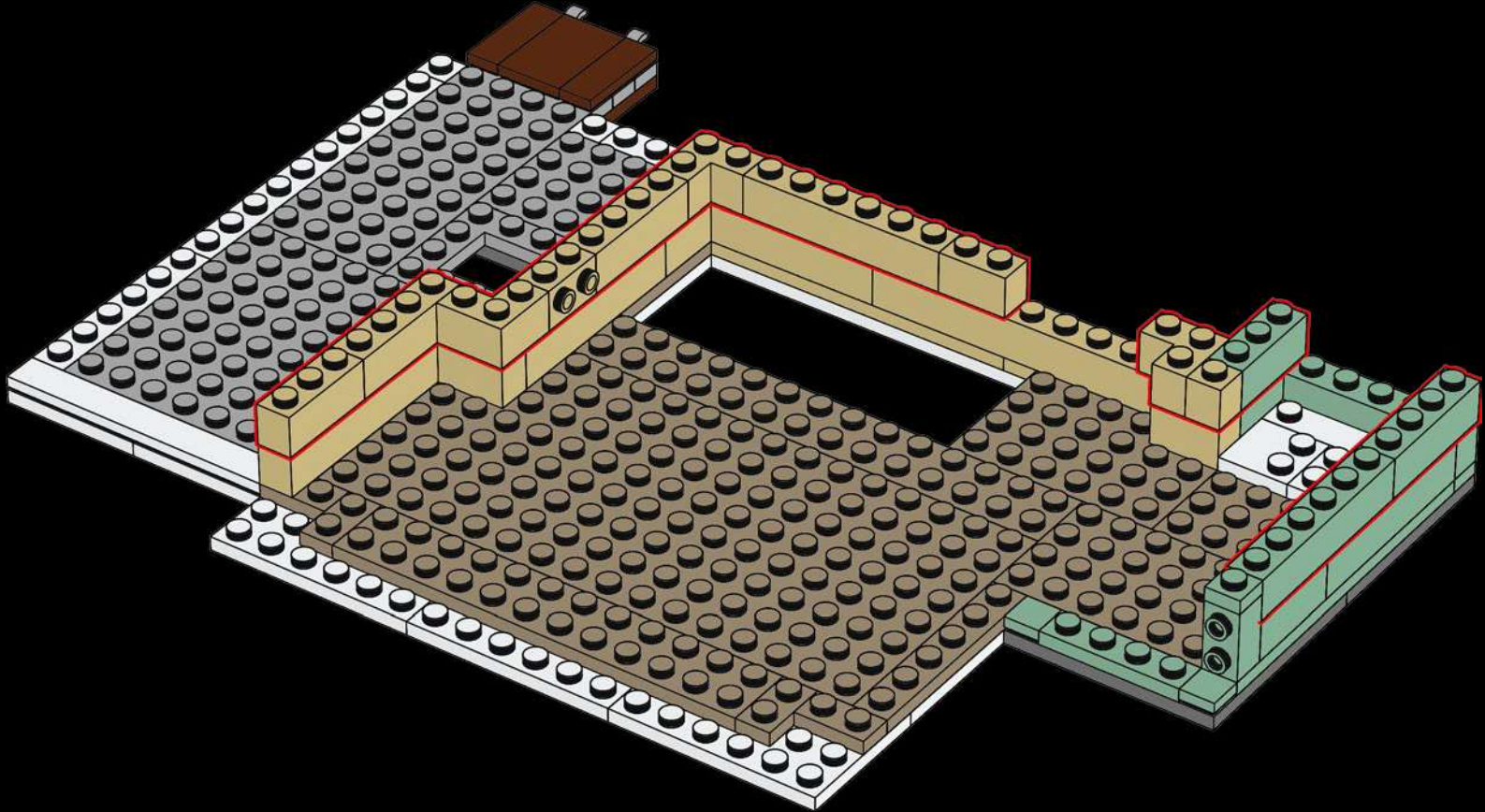







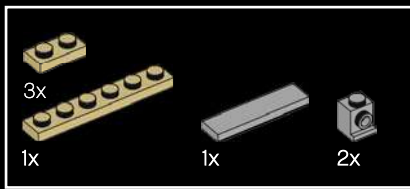

179

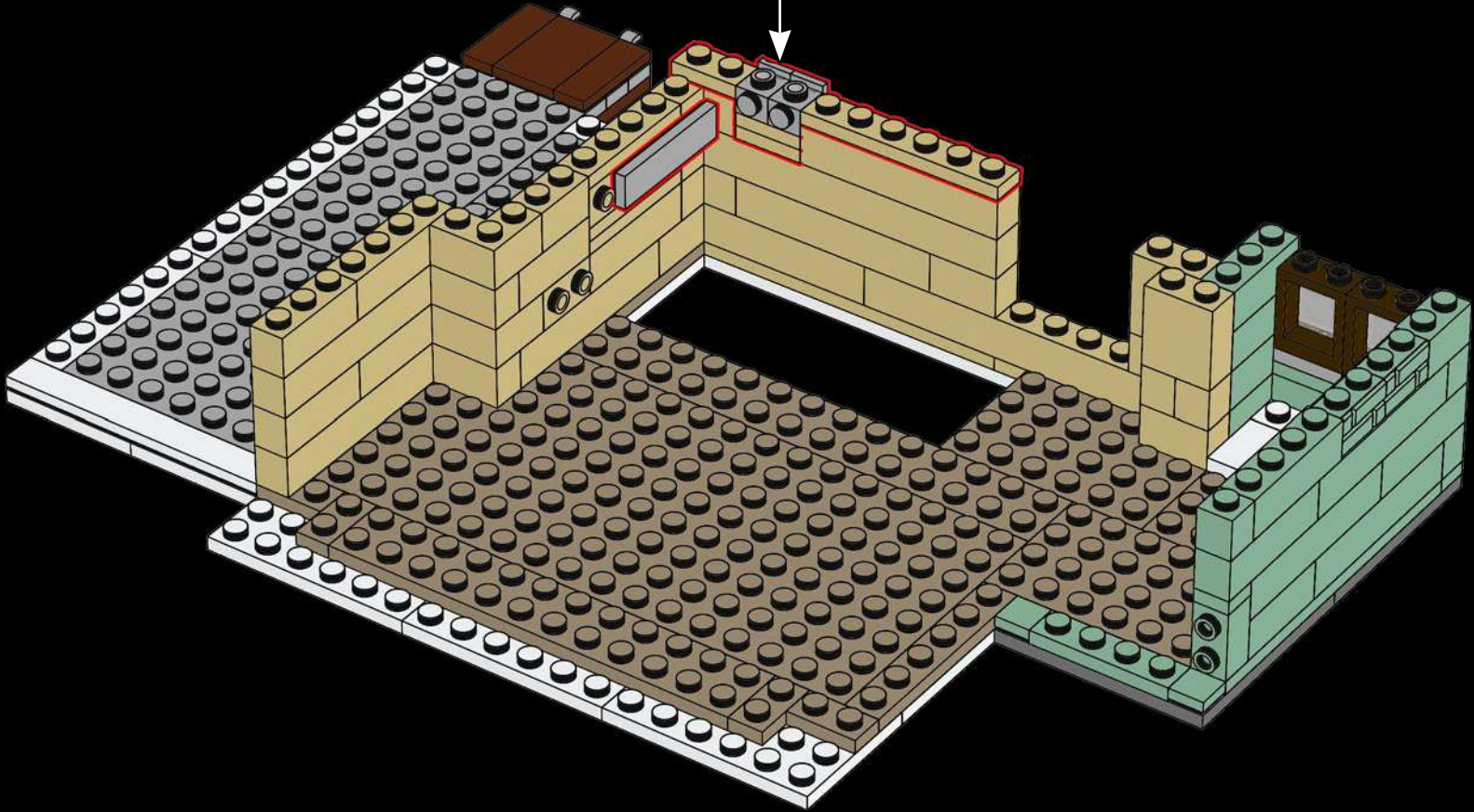
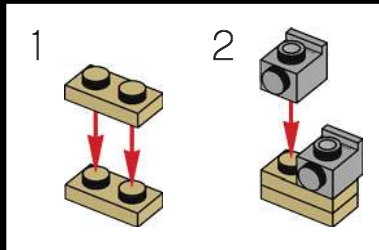



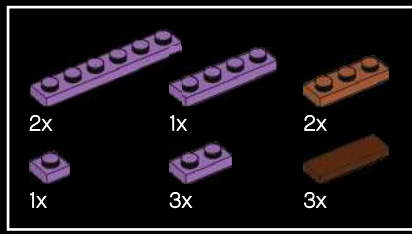

181

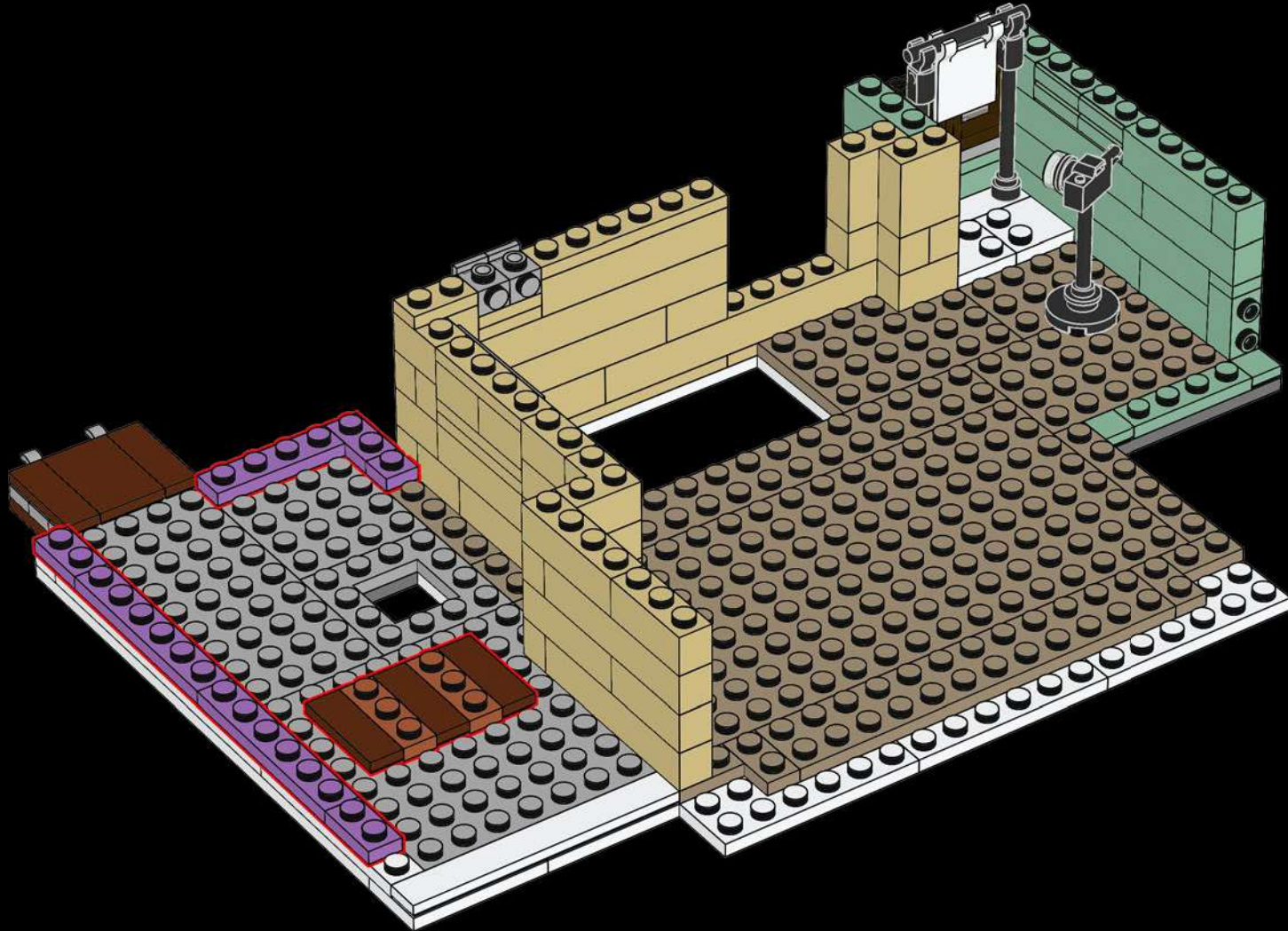

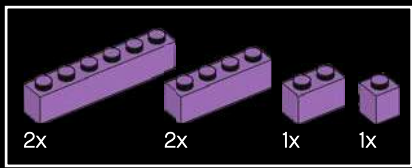

182

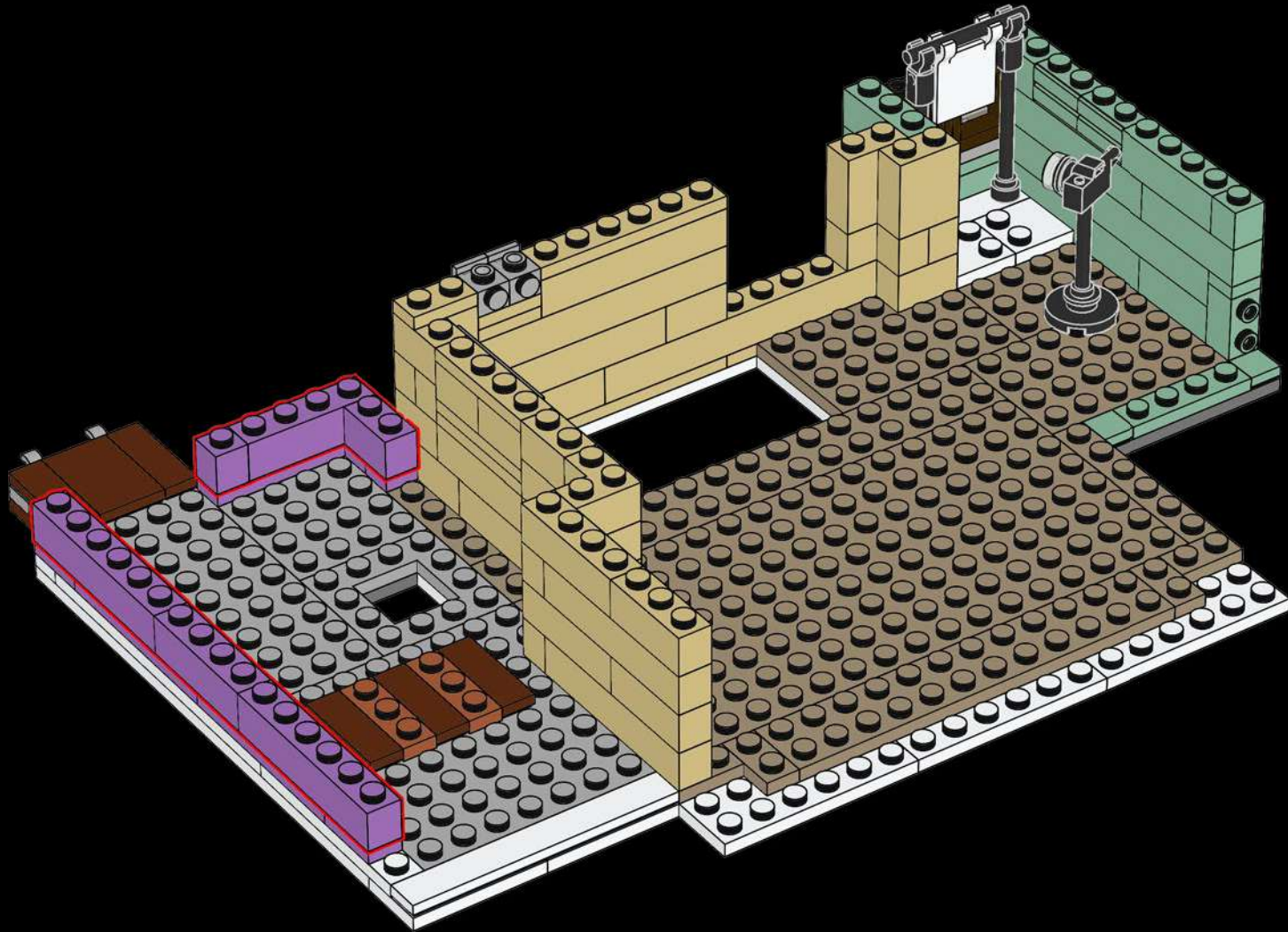

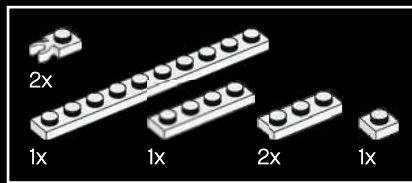

183

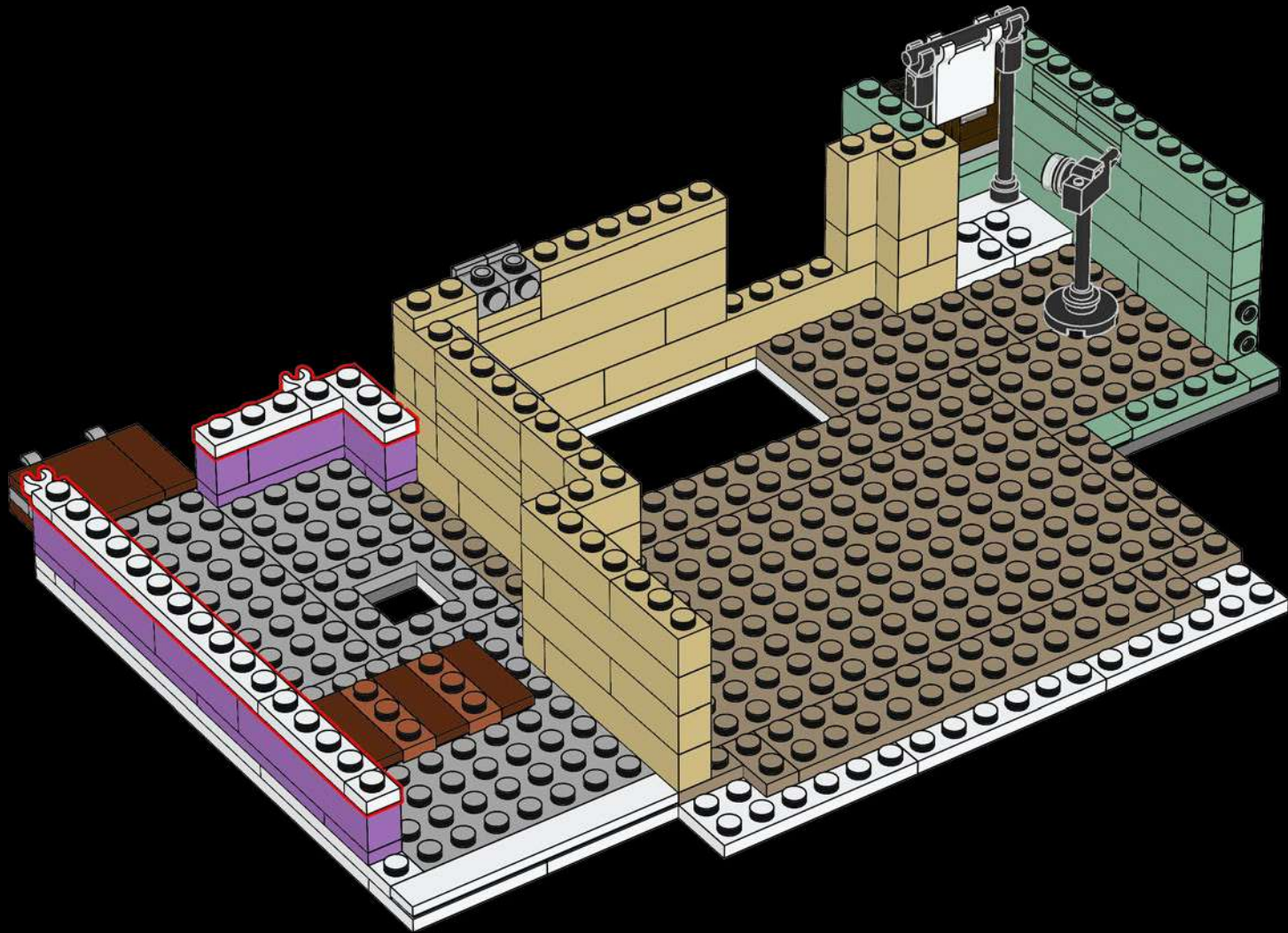

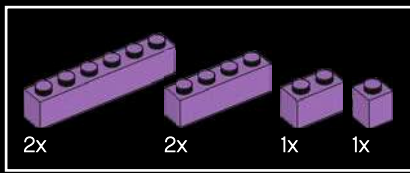

184

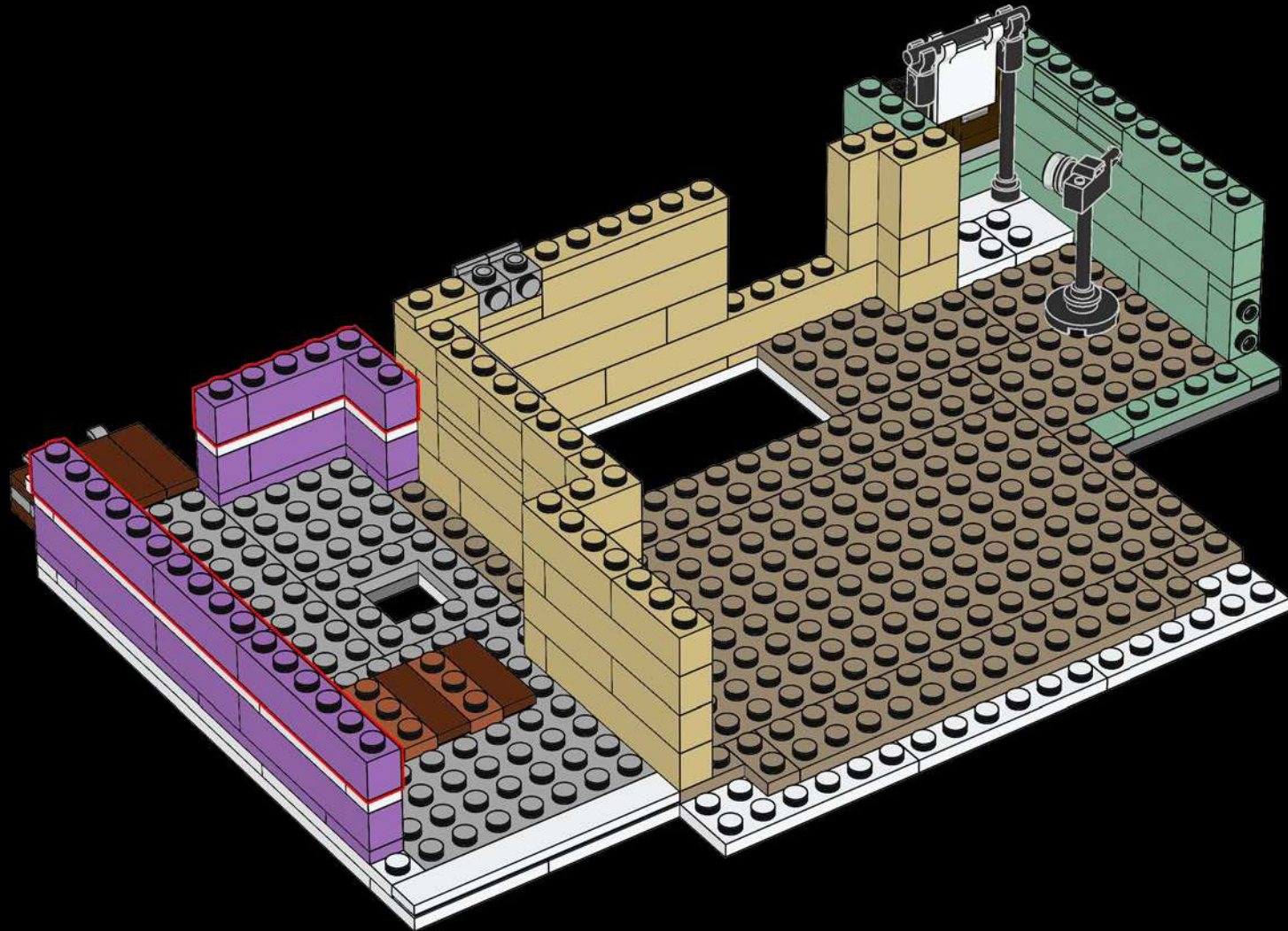

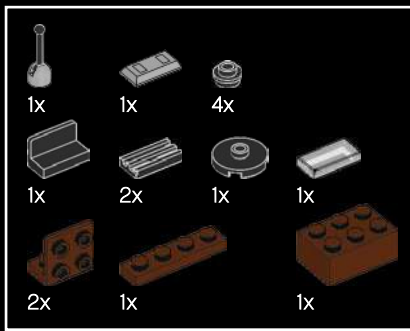

185

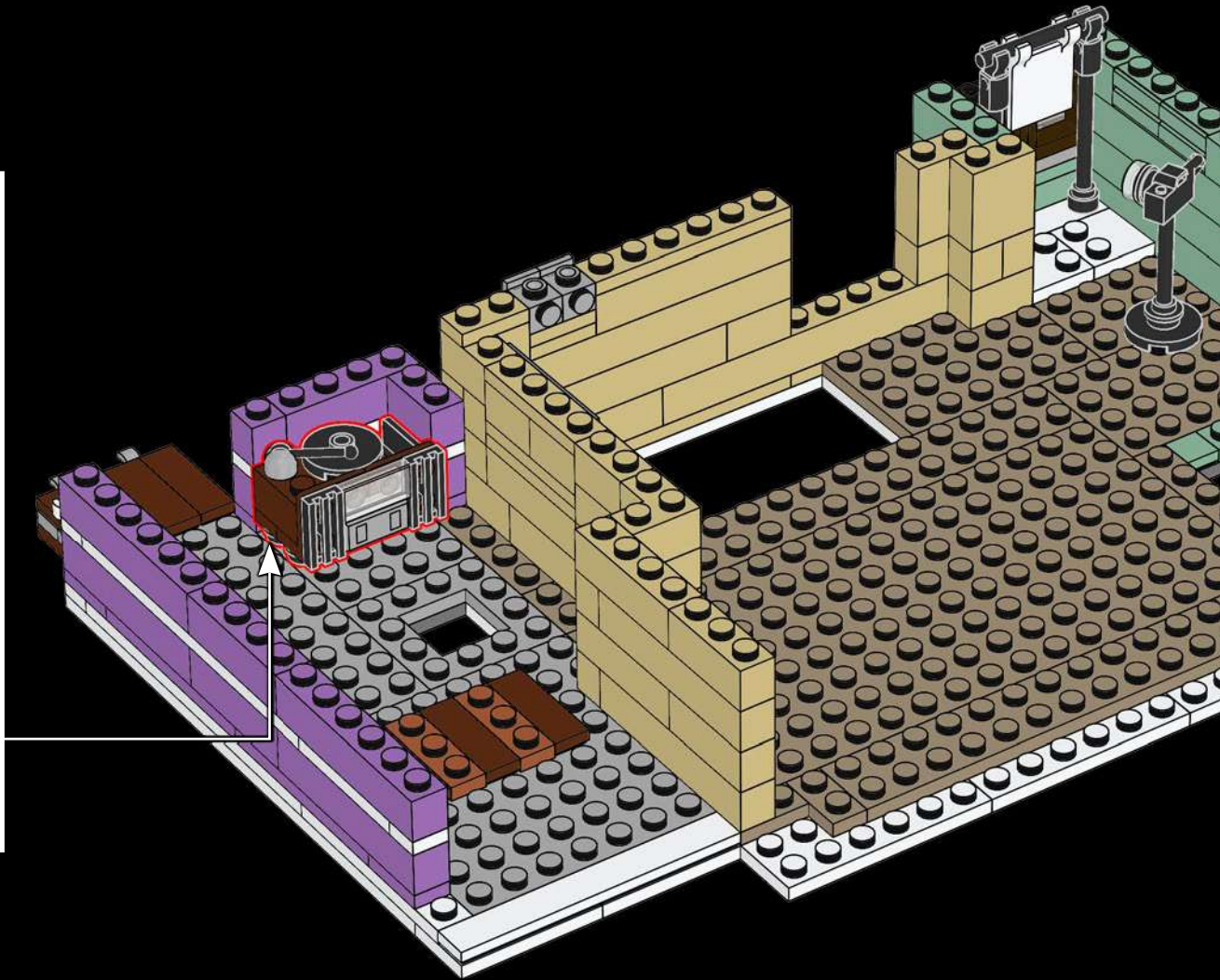
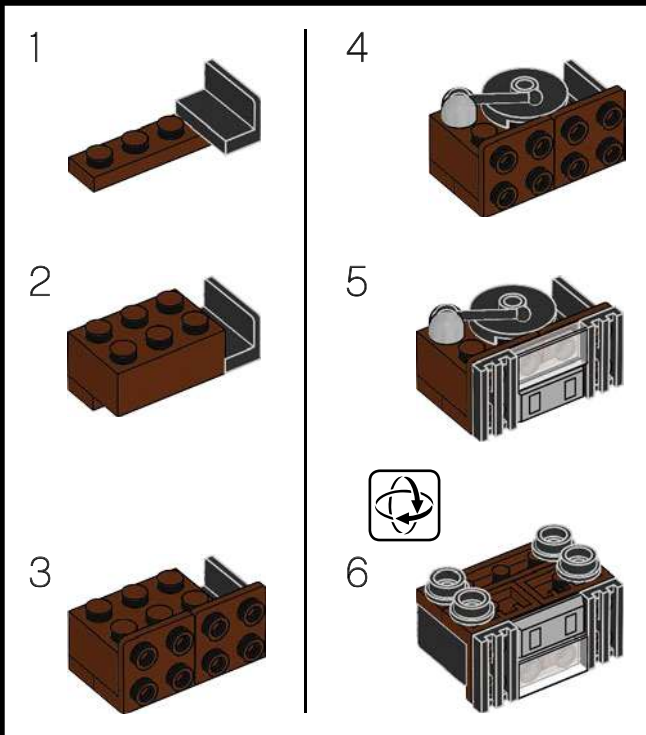

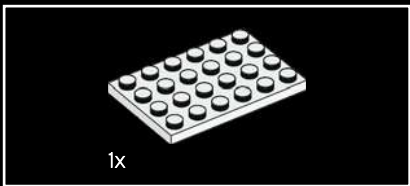

186

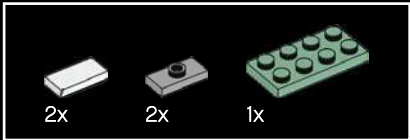
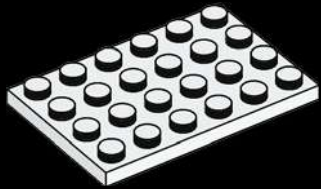

187

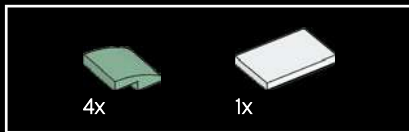
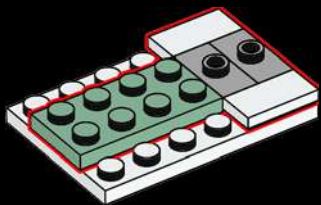

188

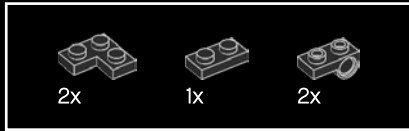
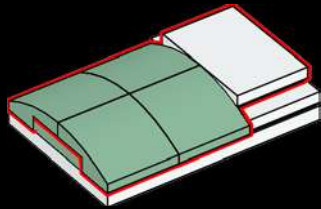

189

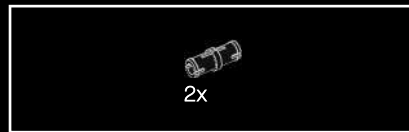
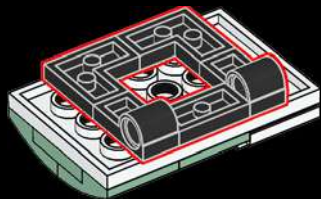

190

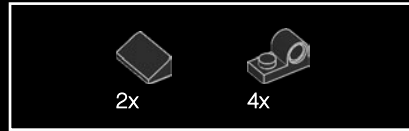
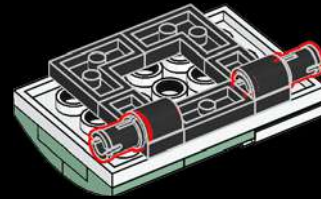

191

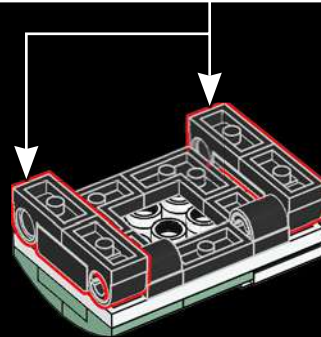
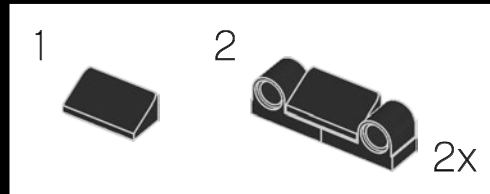



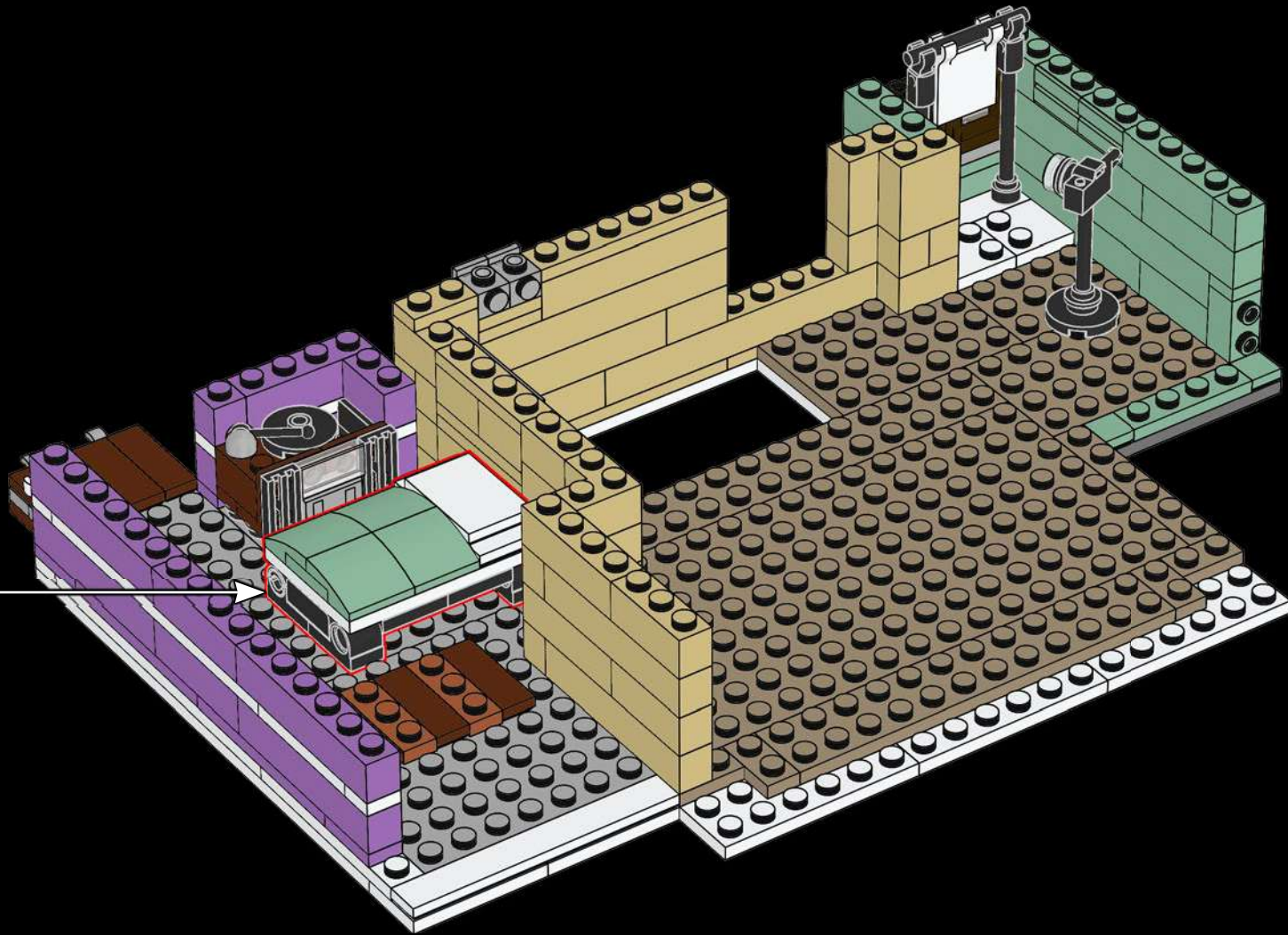



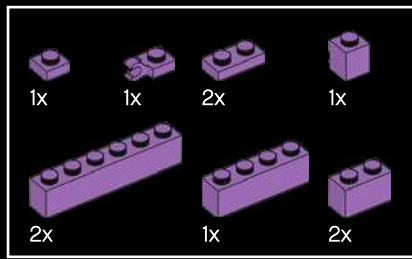

194

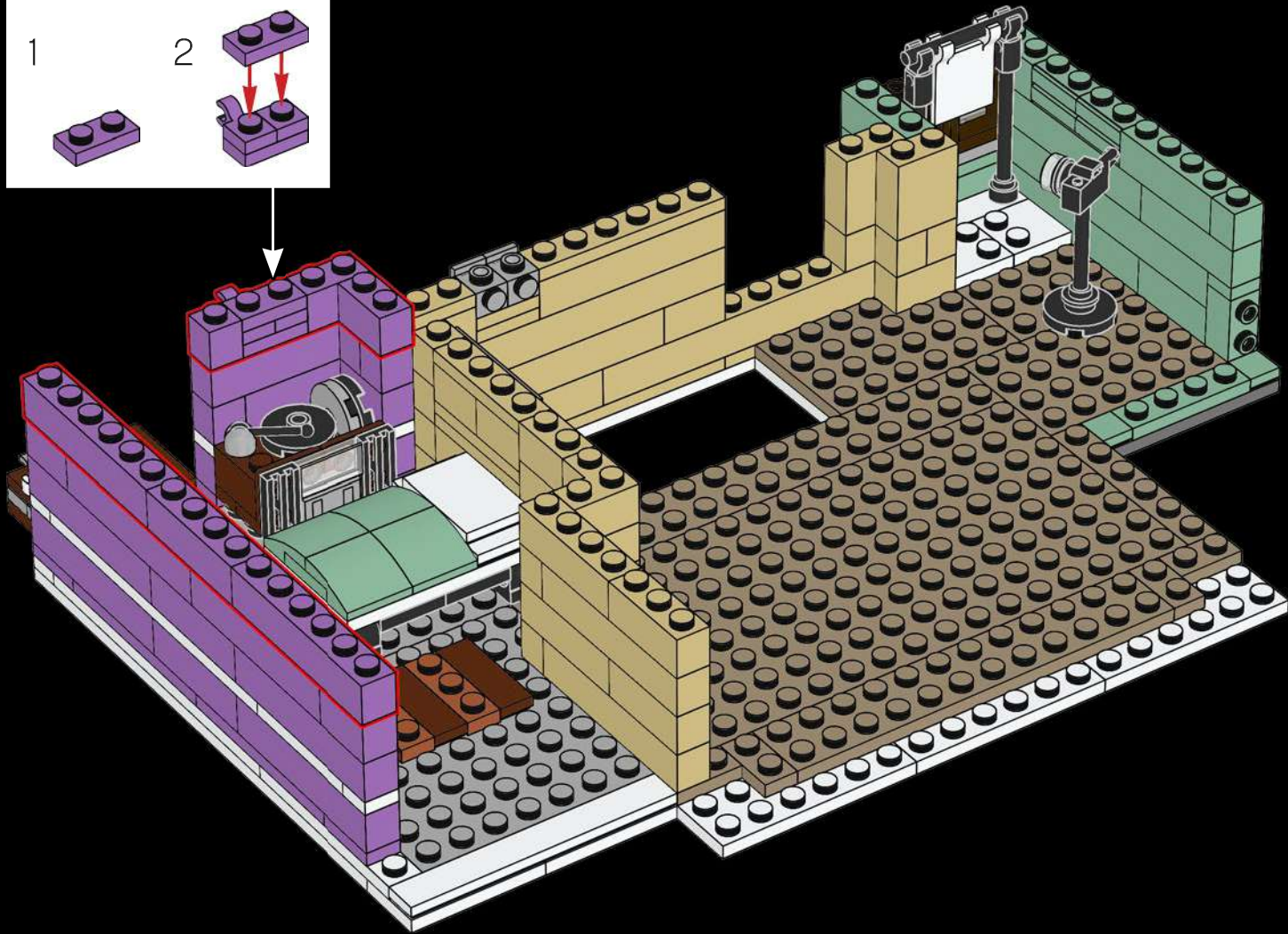
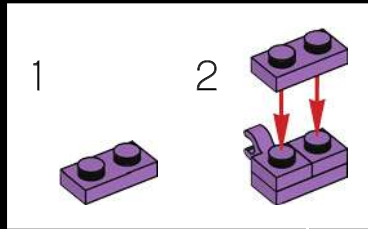

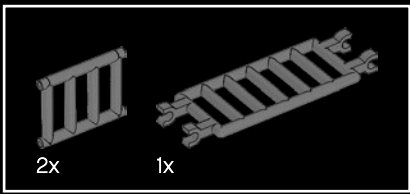

195

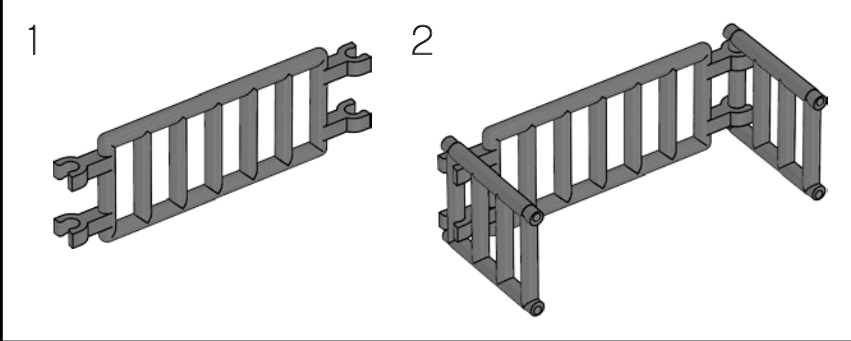
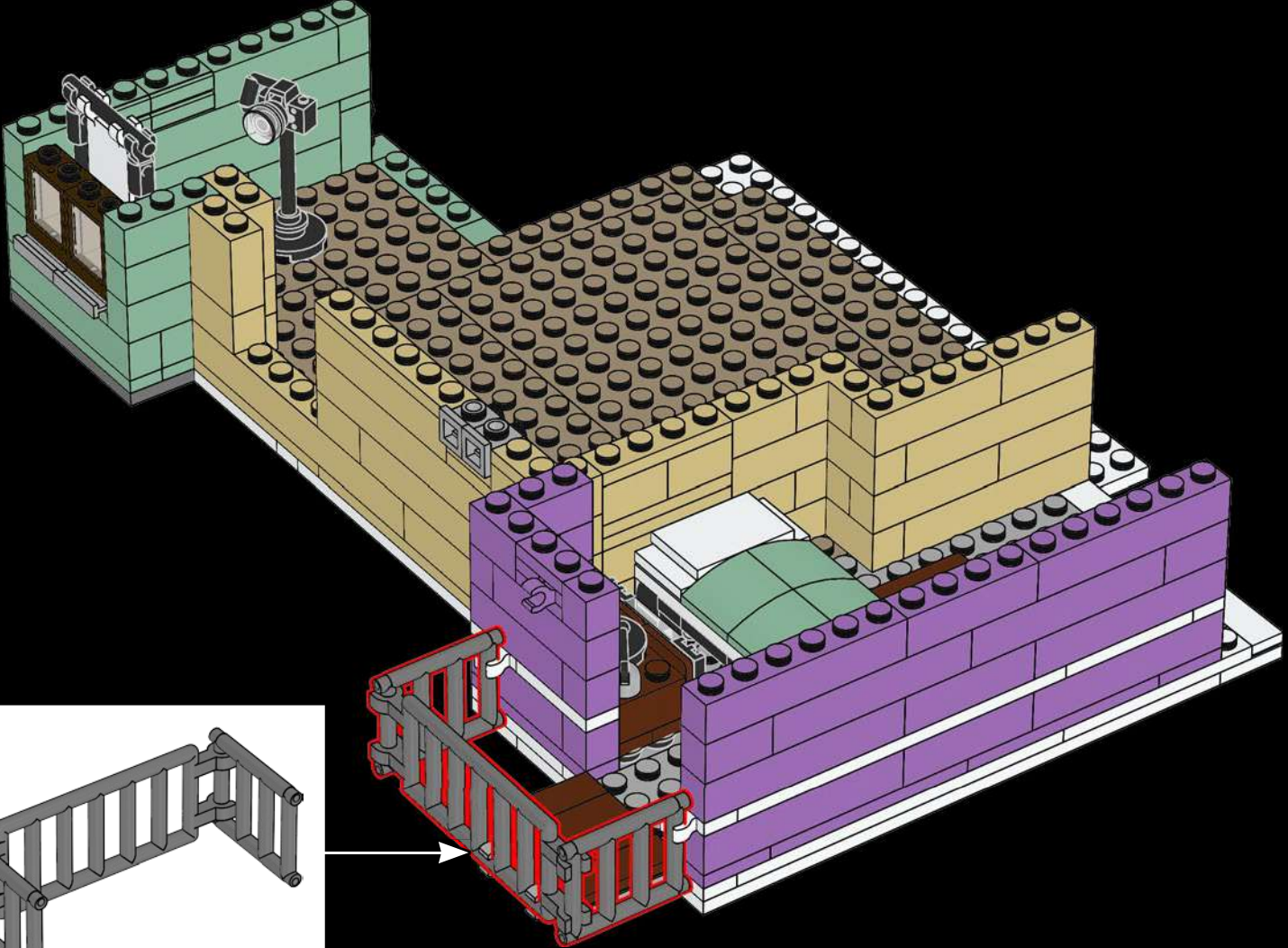

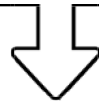

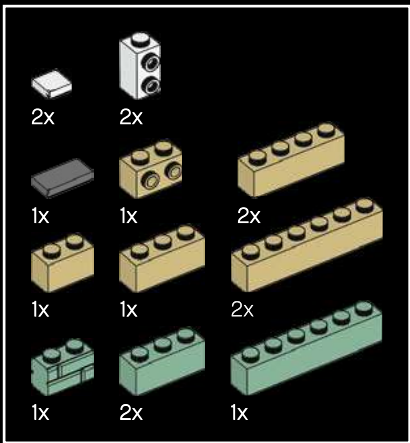

196

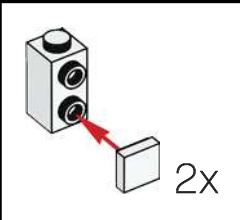
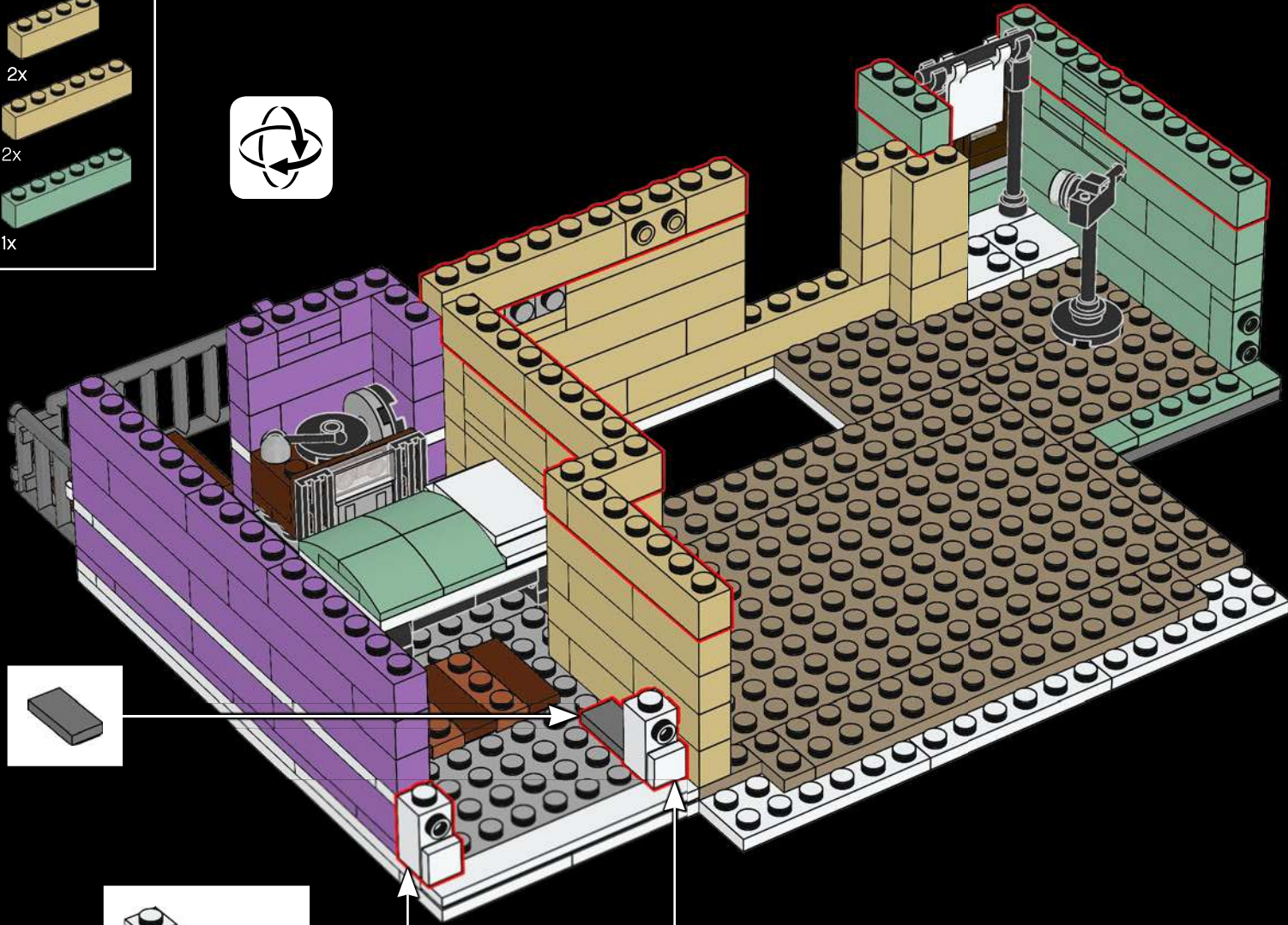

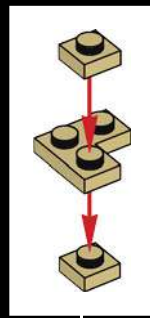
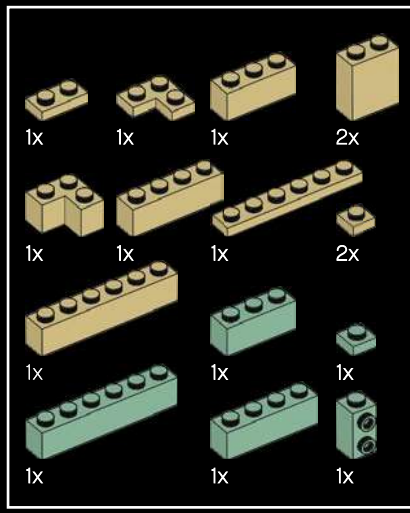

197

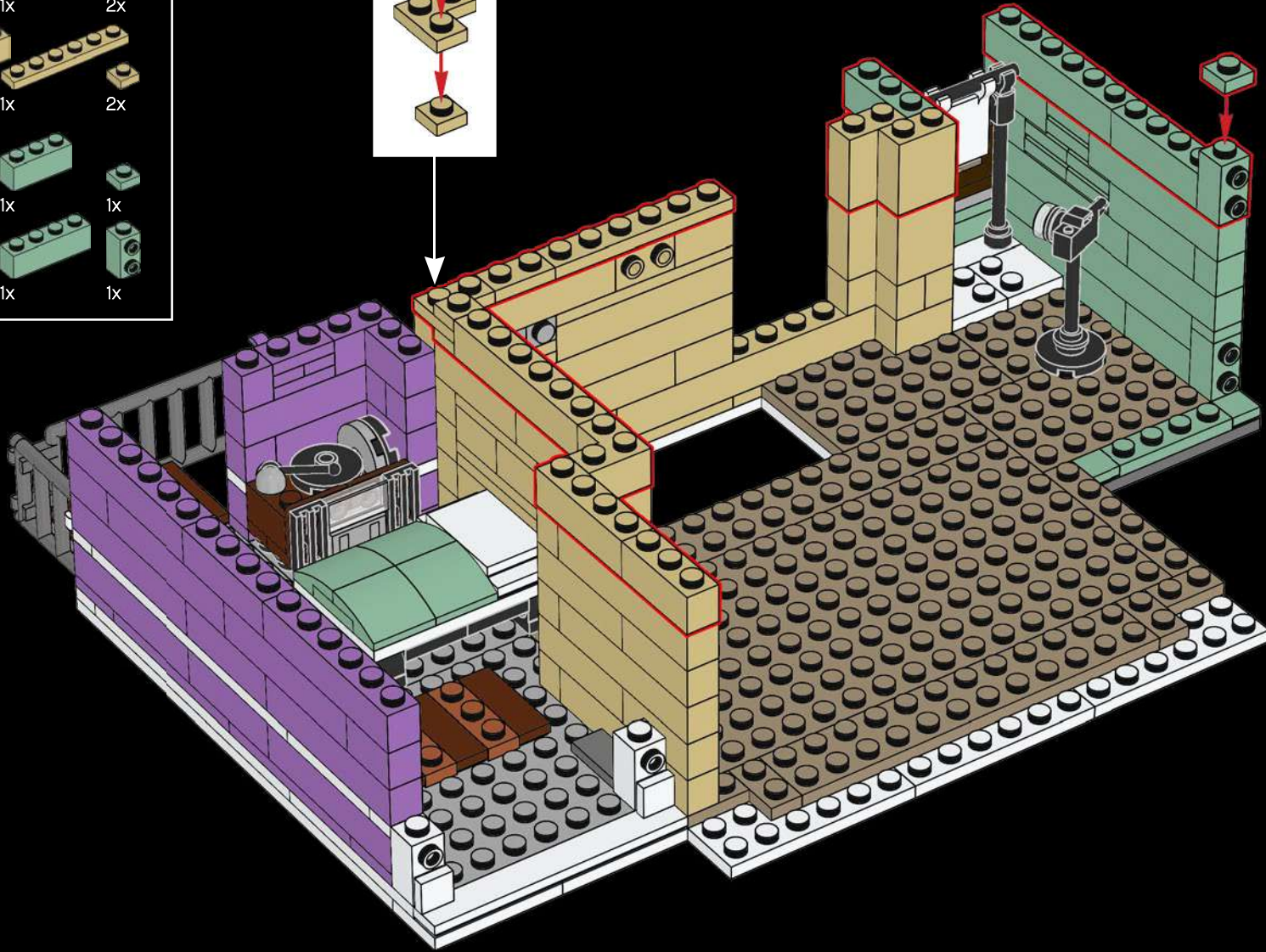

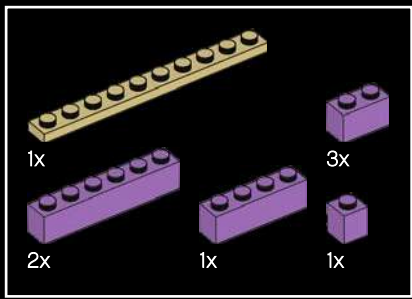

198

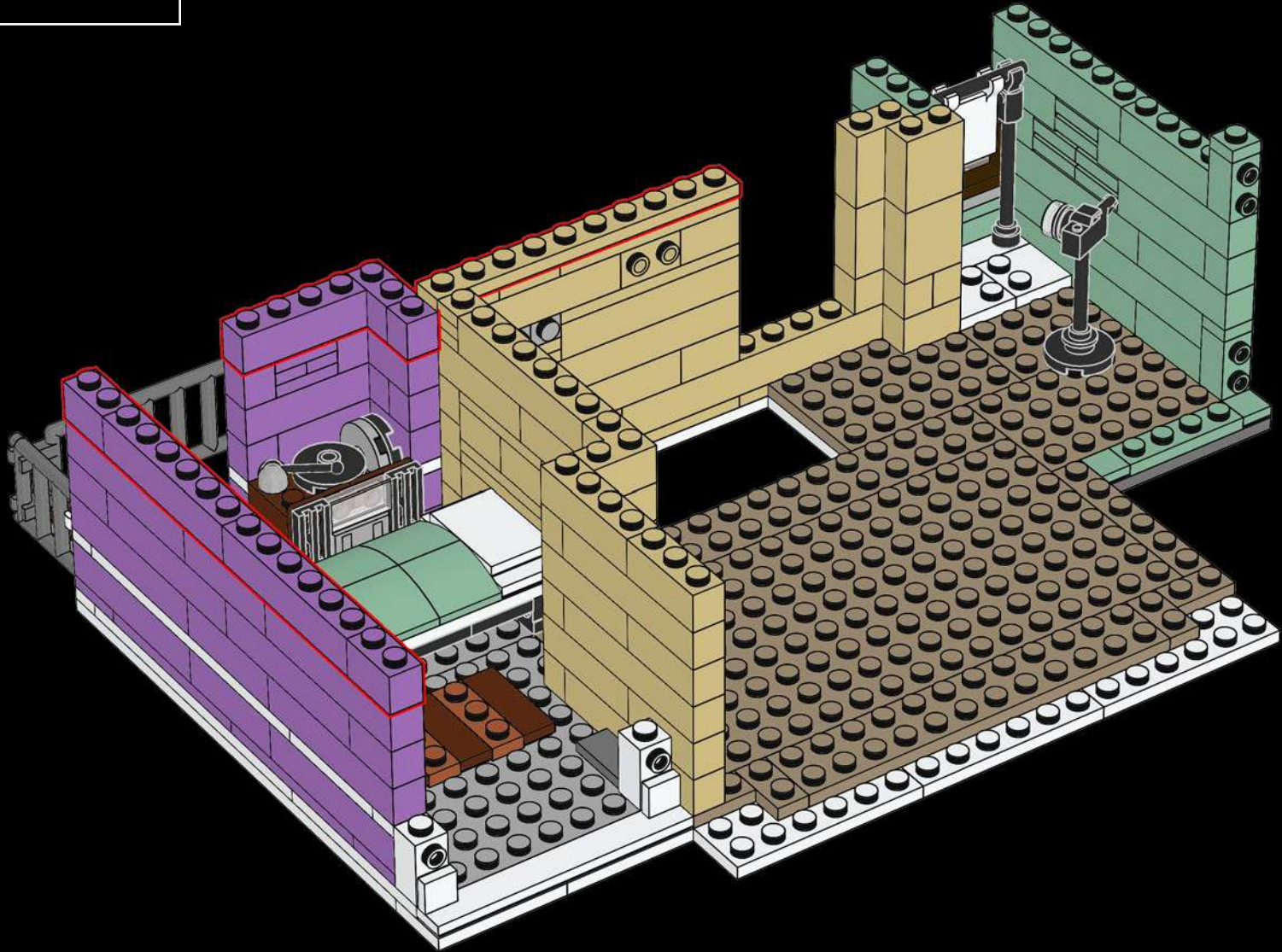



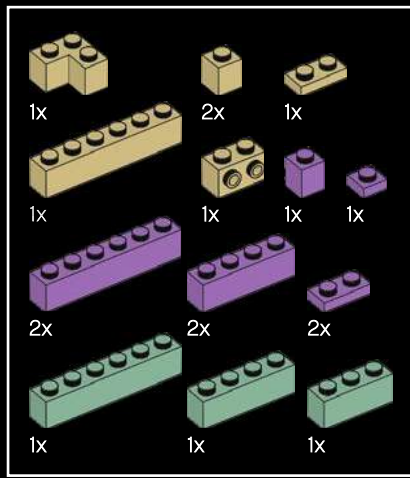

199

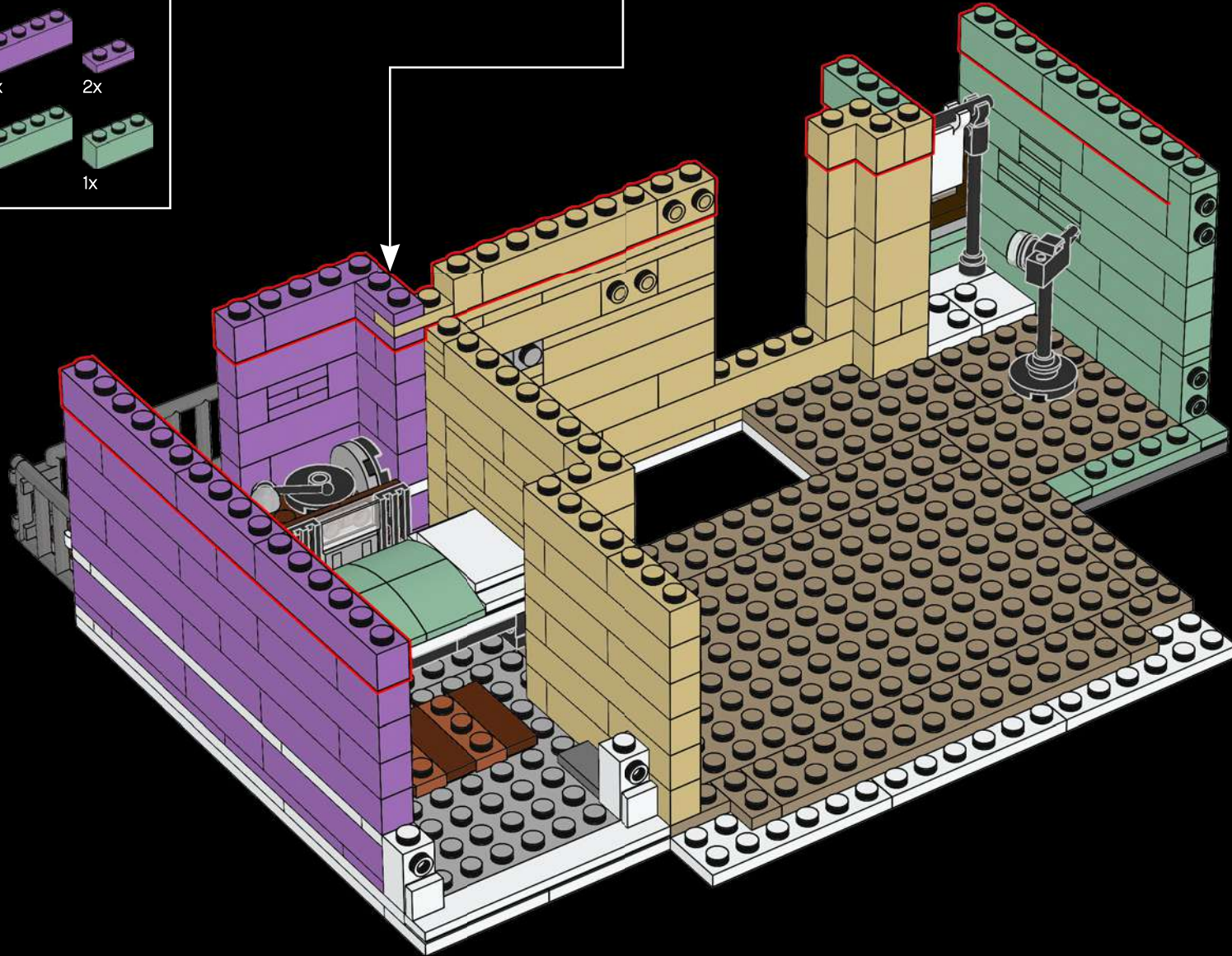

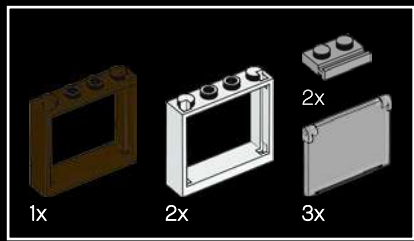

200

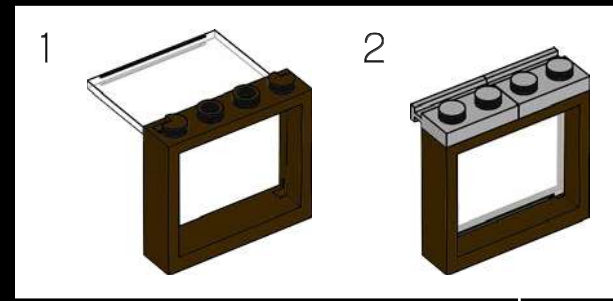
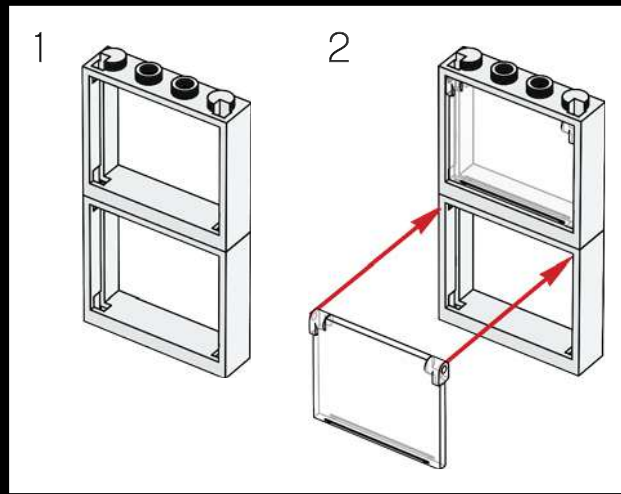

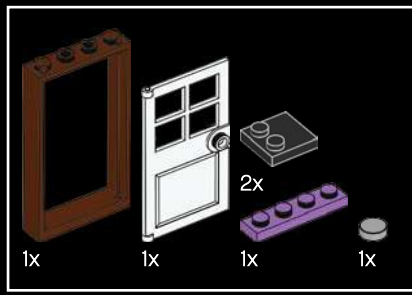

201

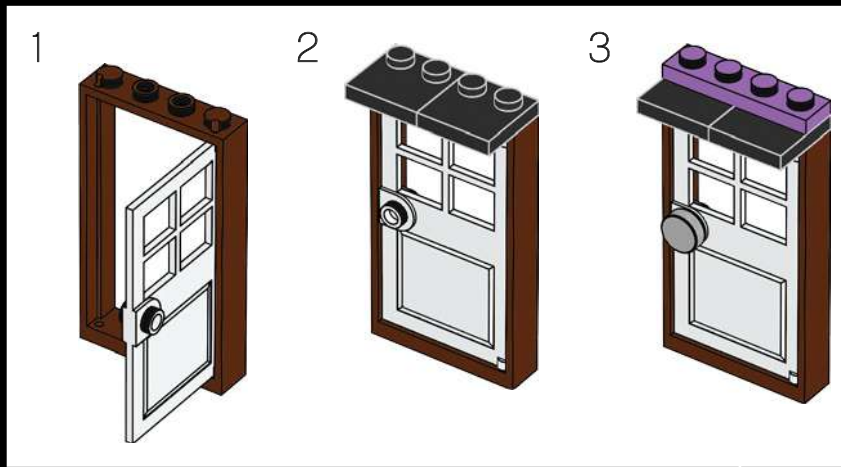

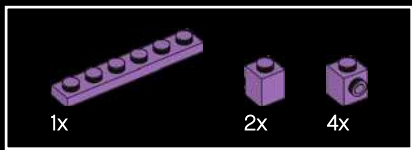

202

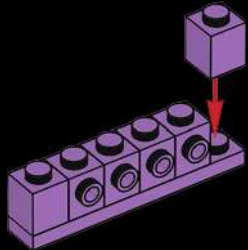

203

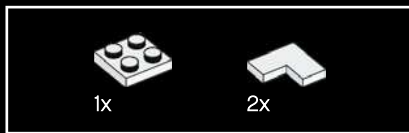
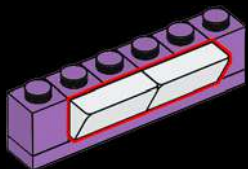

204

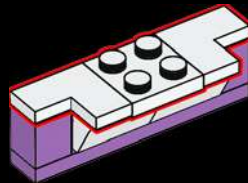

205

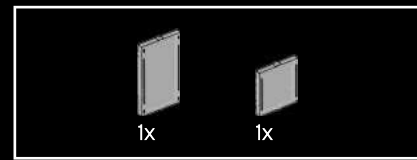
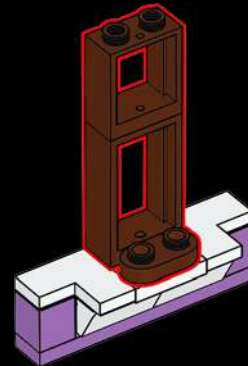

206

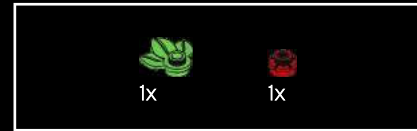
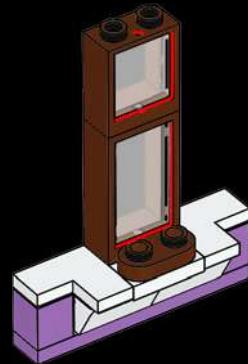

207





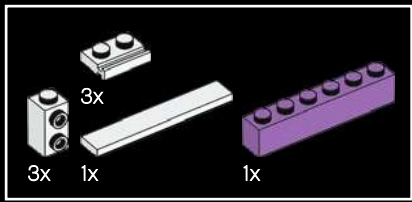

209

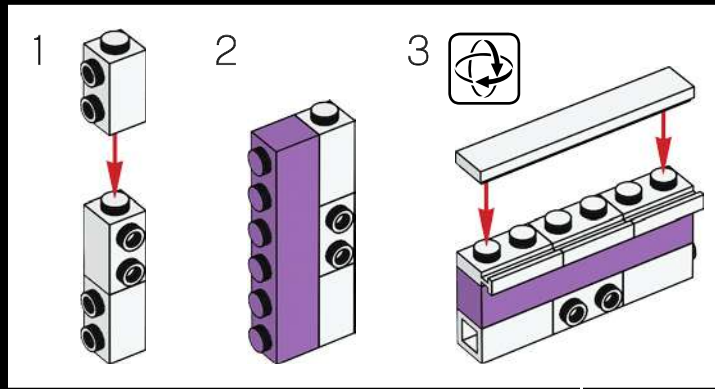

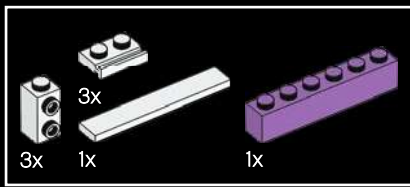

210

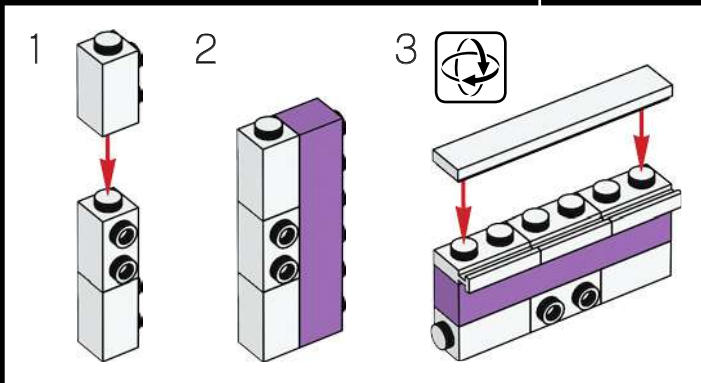





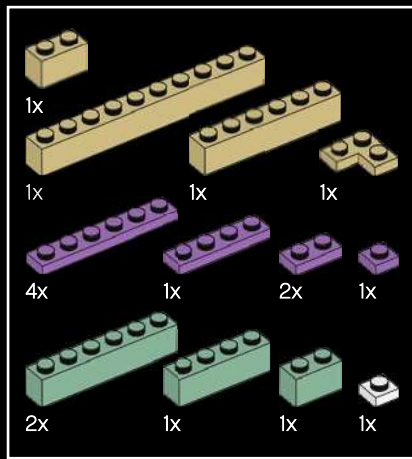

212





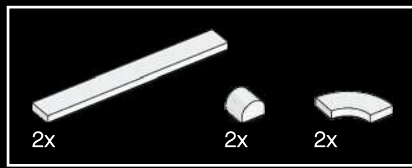

214

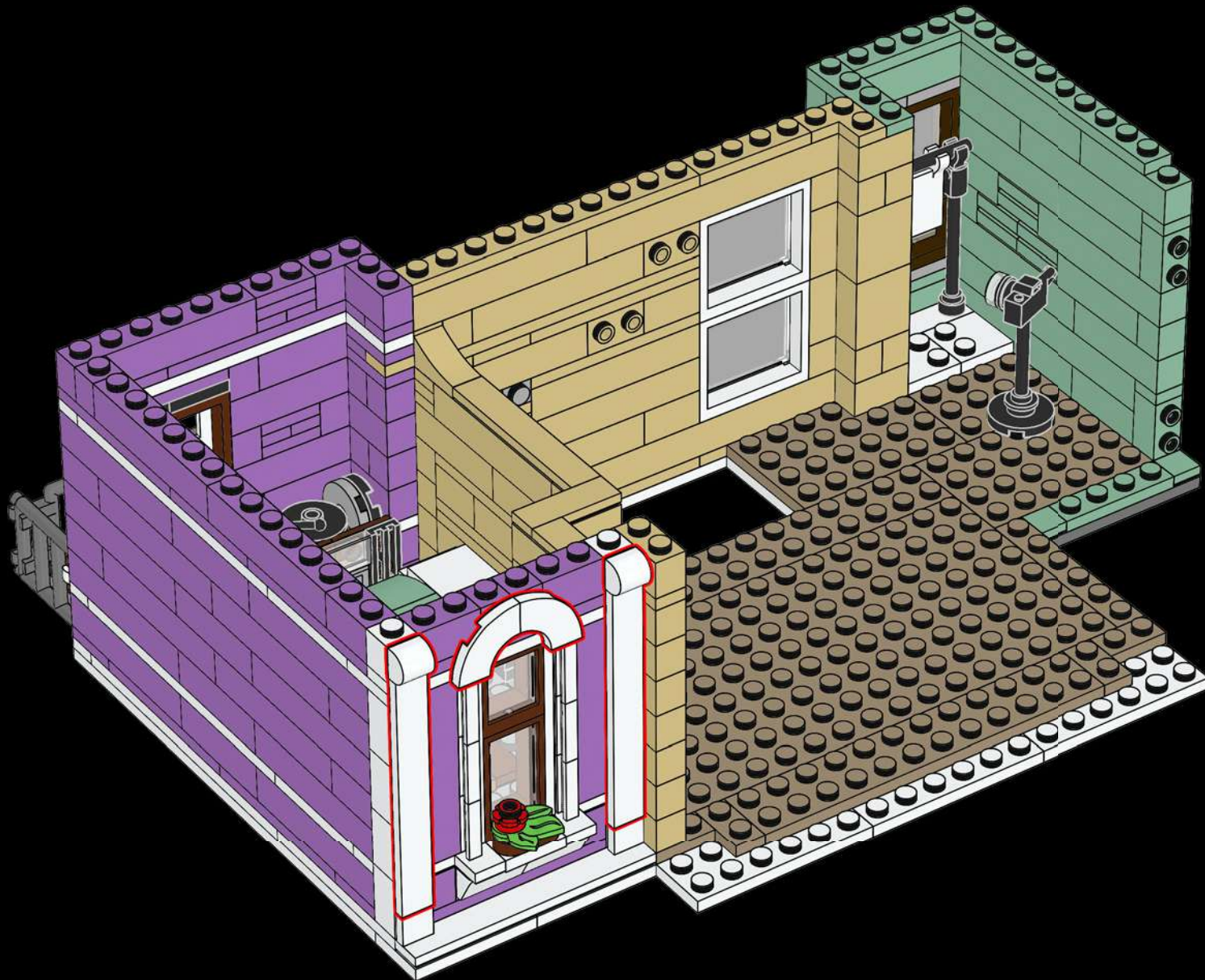

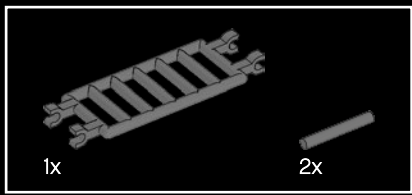

215

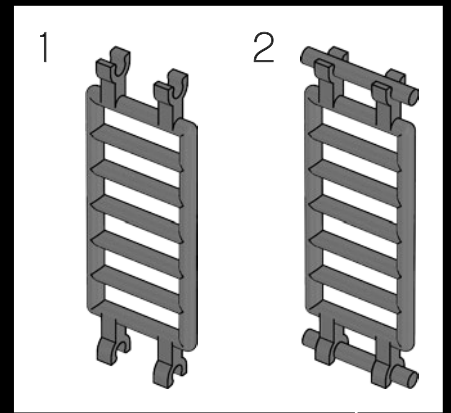

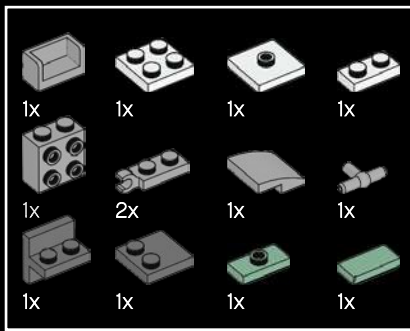

216

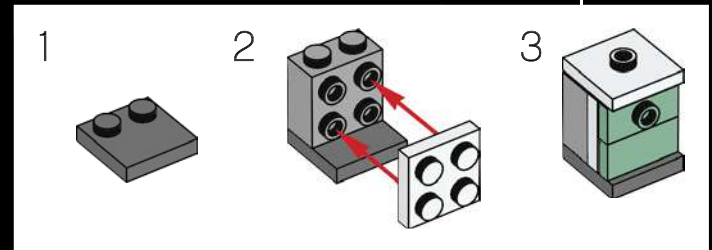
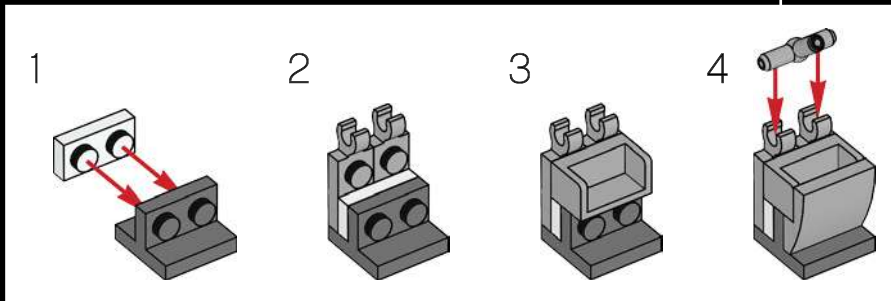
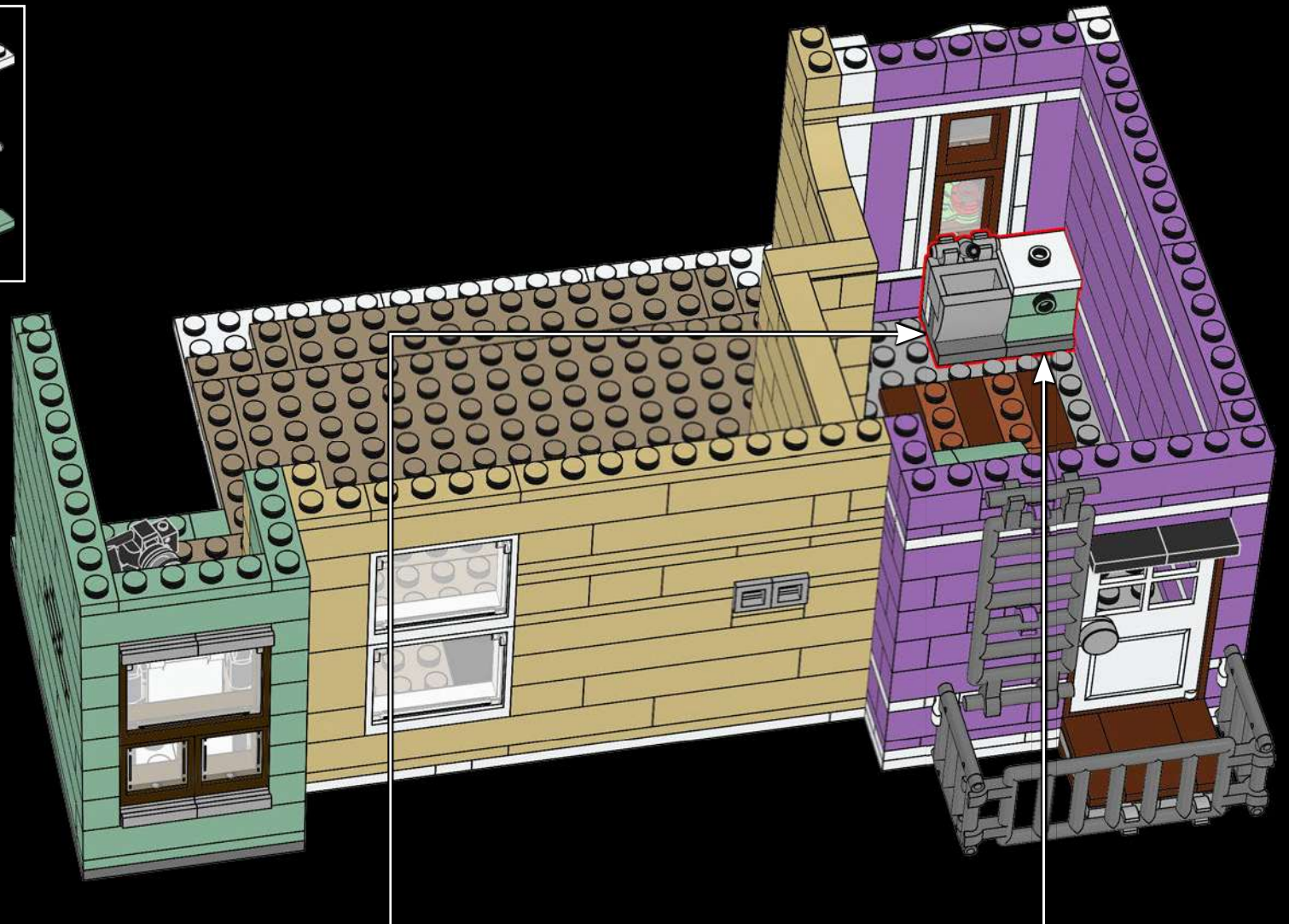



The veteran police officer is ready to solve any crime that comes his way.

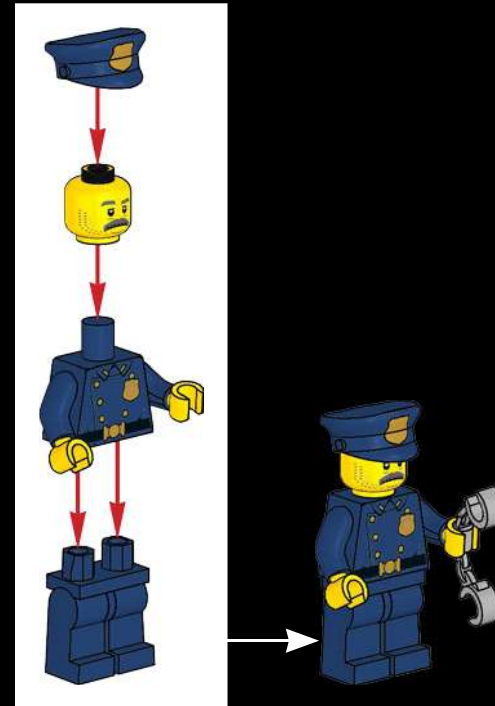
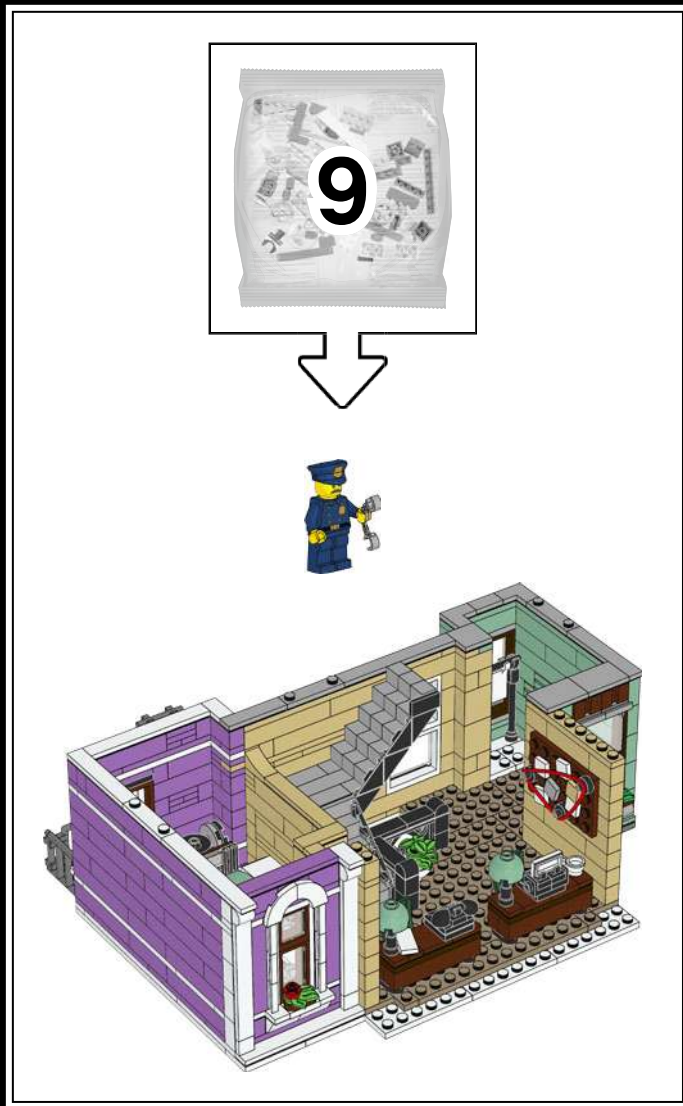

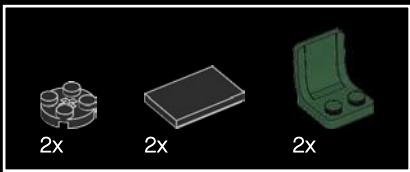

218

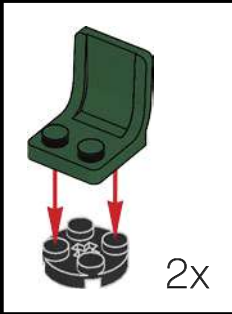
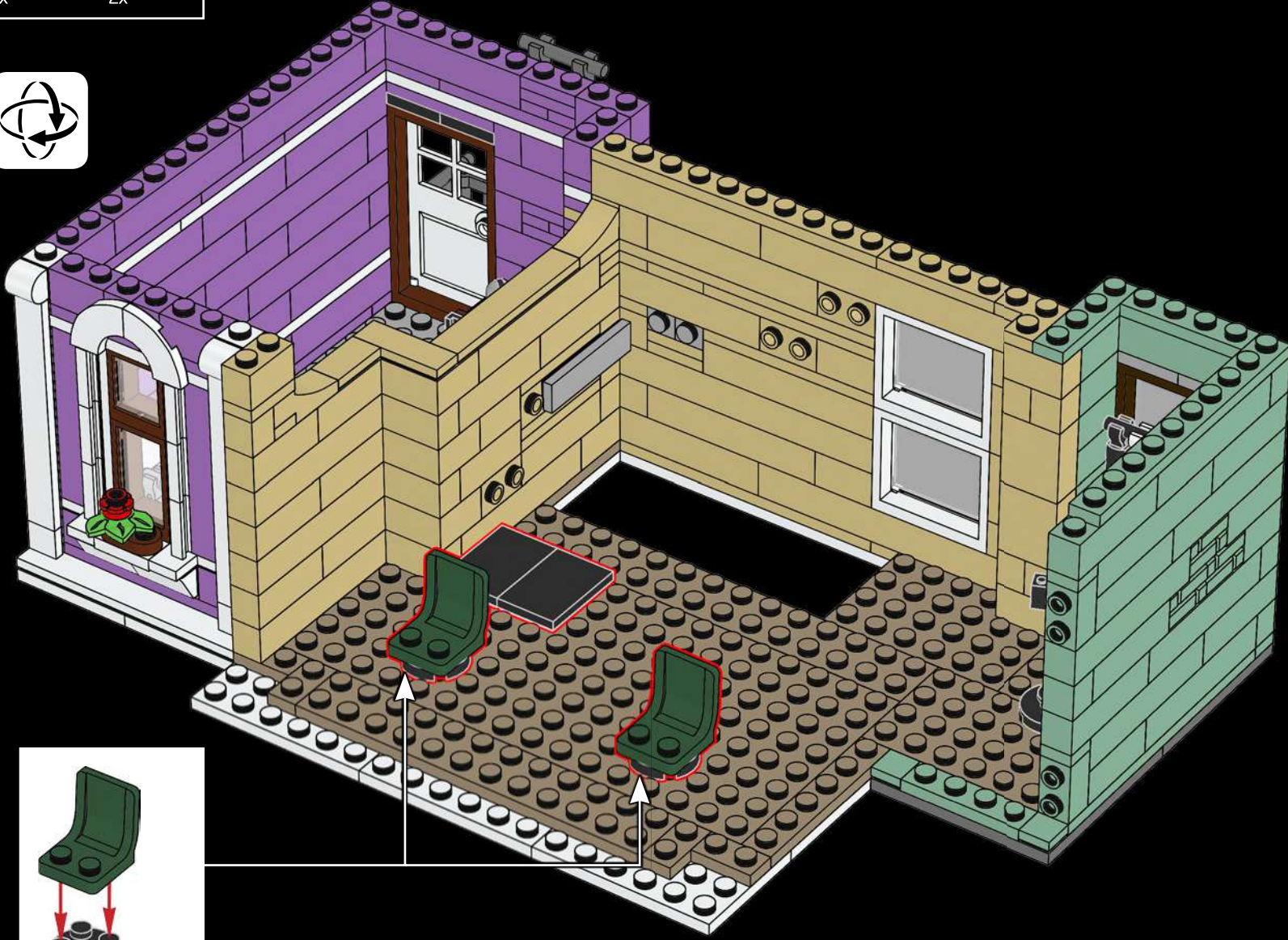



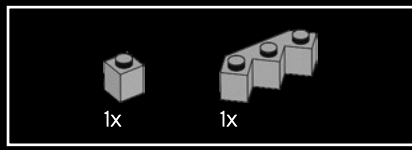

219

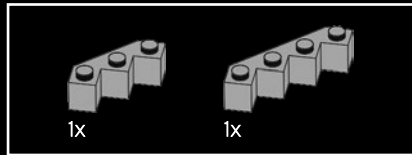
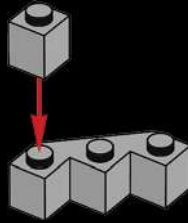

220

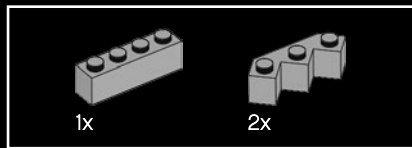
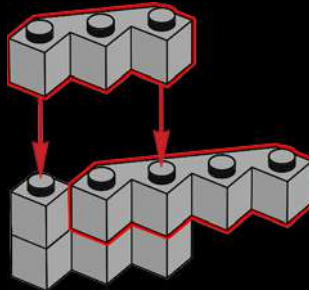

221

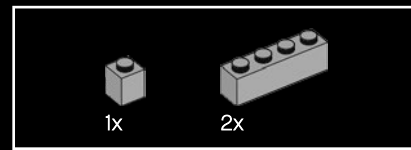
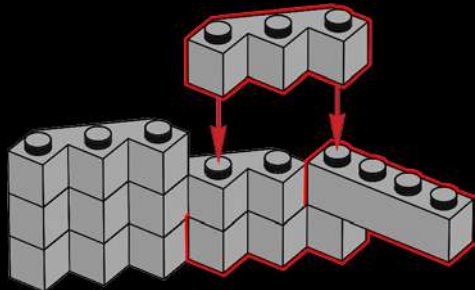

222

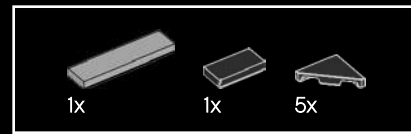
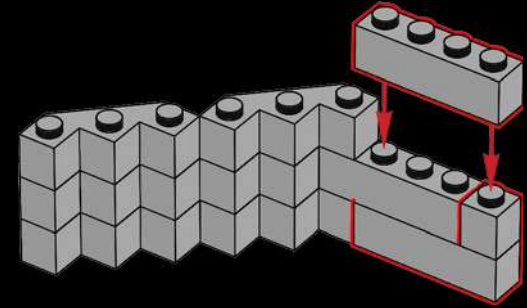

223

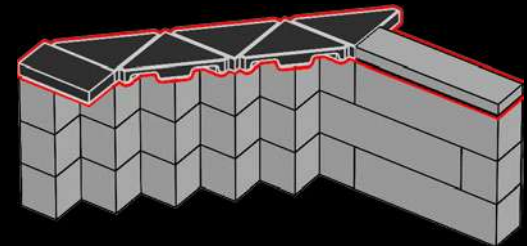

224

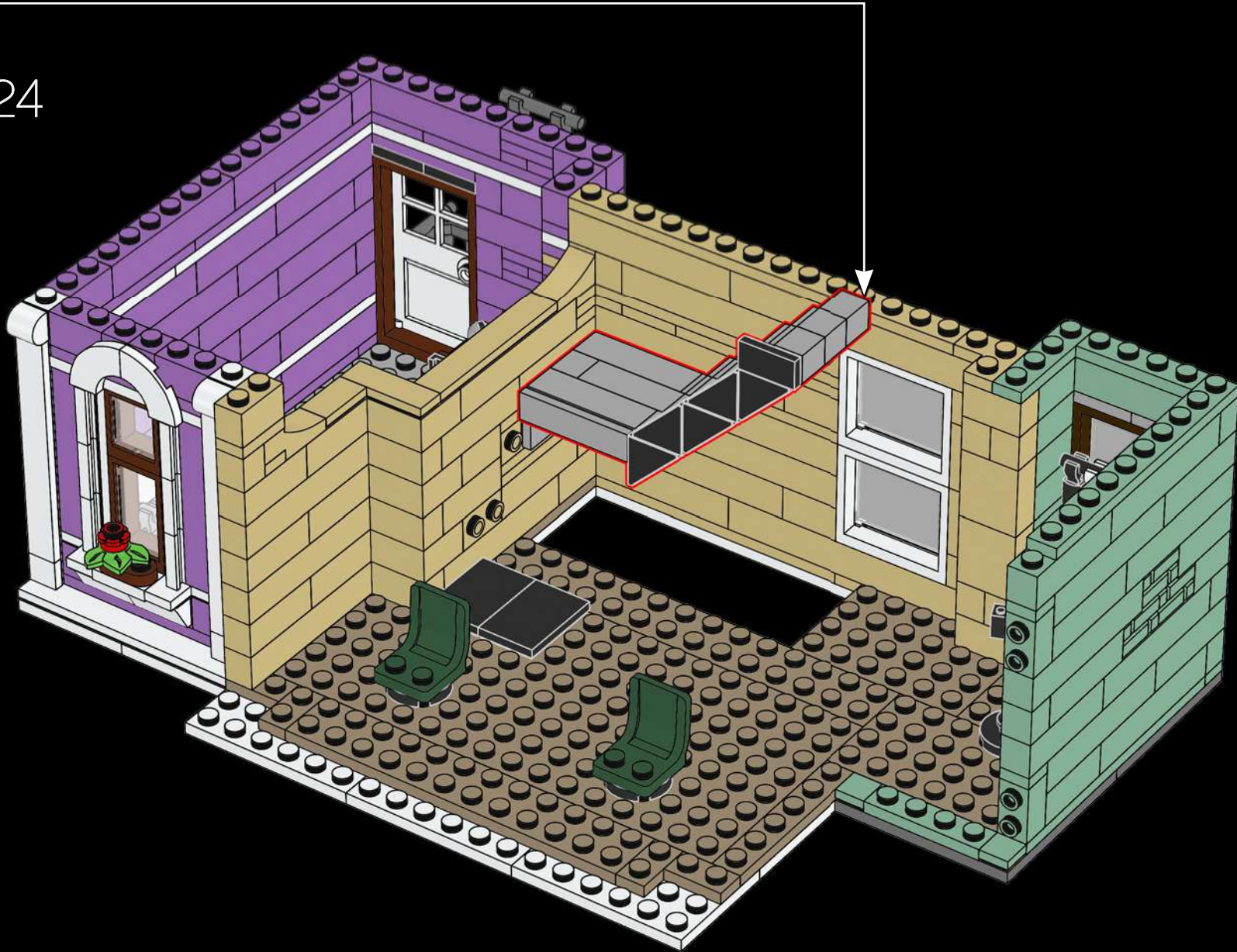

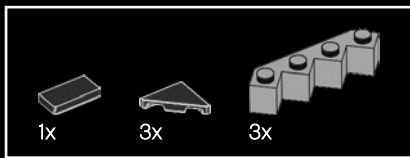

225

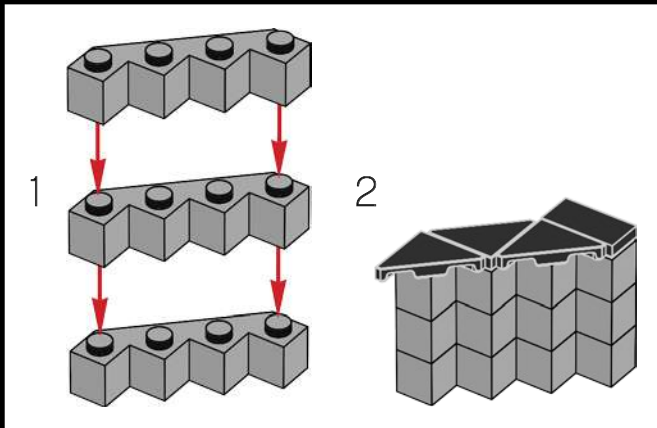
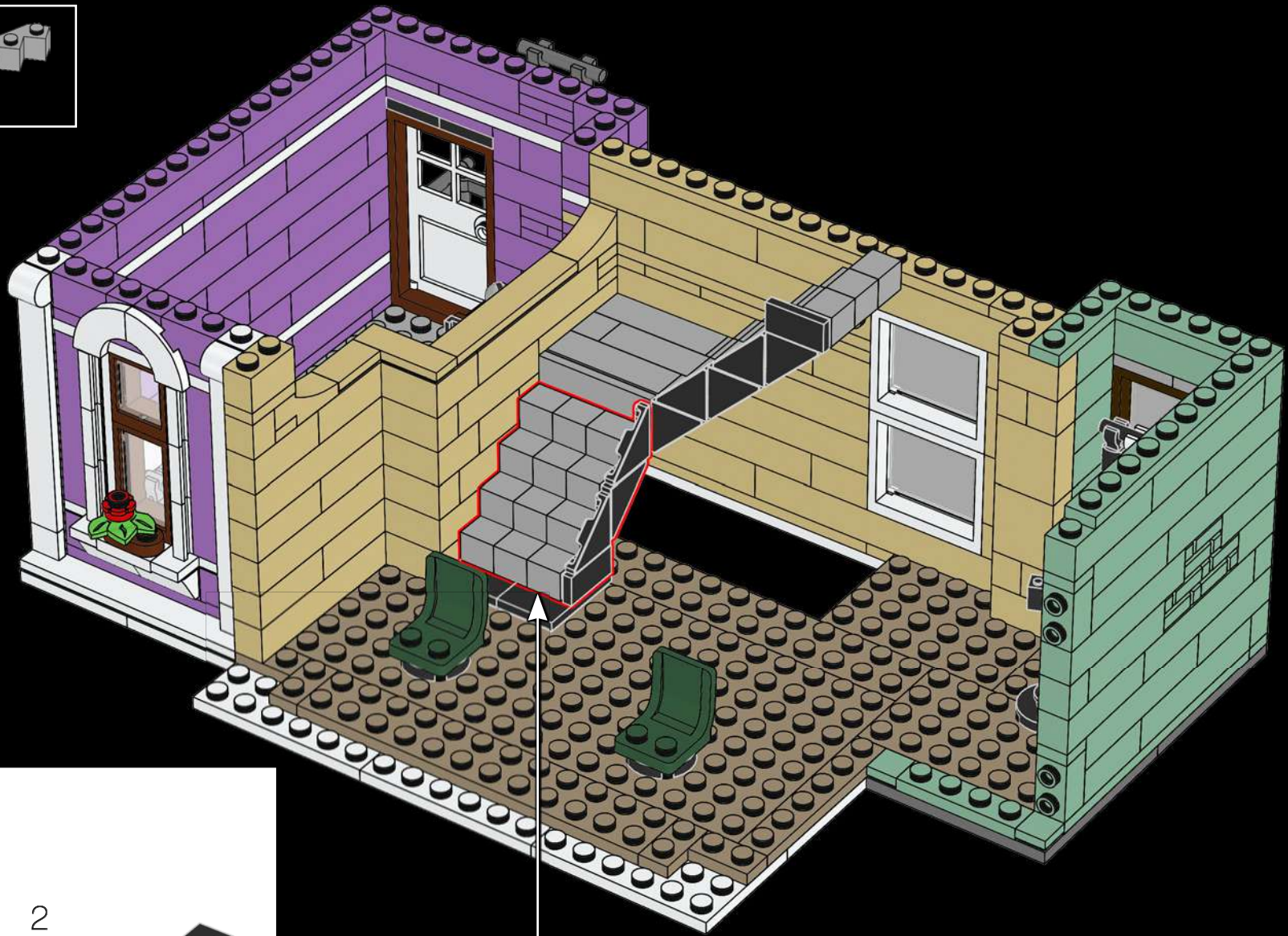

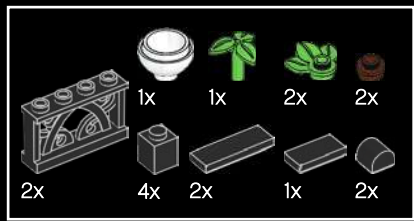

226

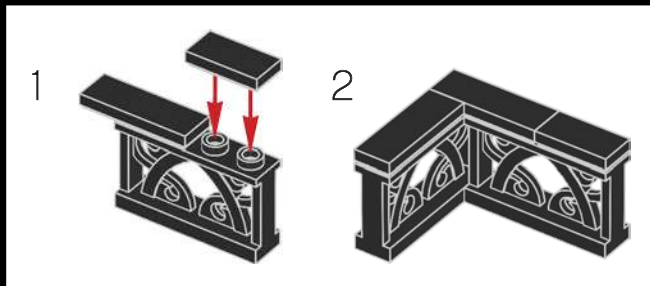
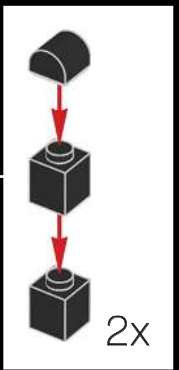

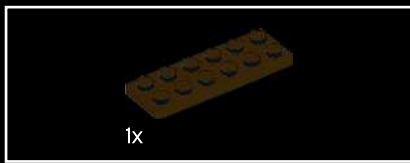

227



229

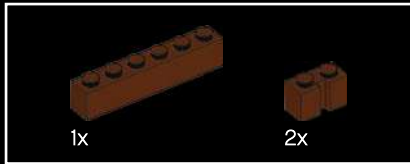
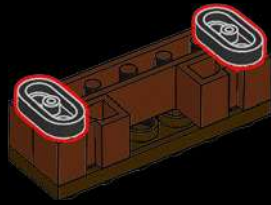

228

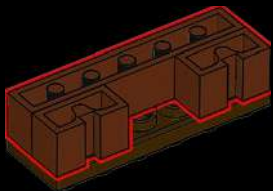

230

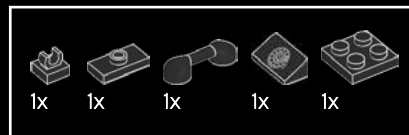
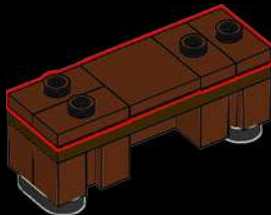

231

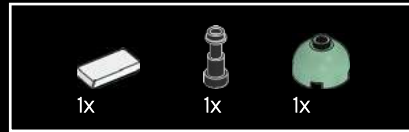
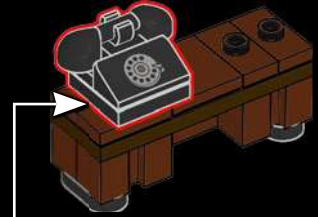
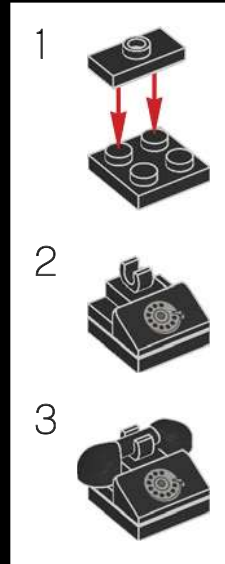

232

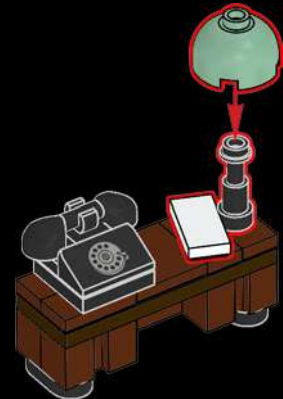

233



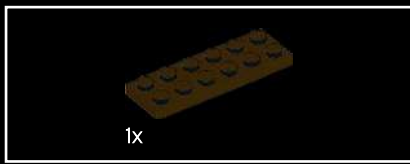

234

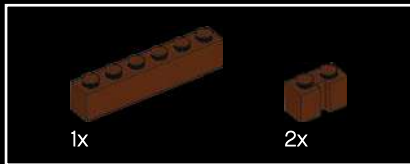
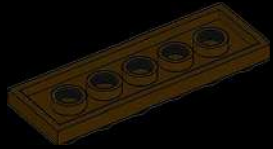

235

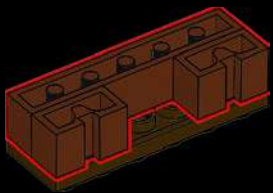

236

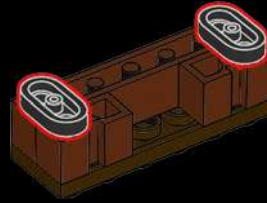

237

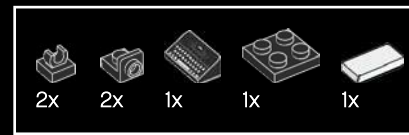
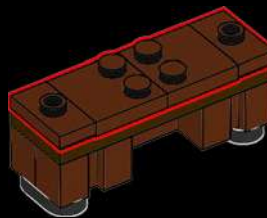

238

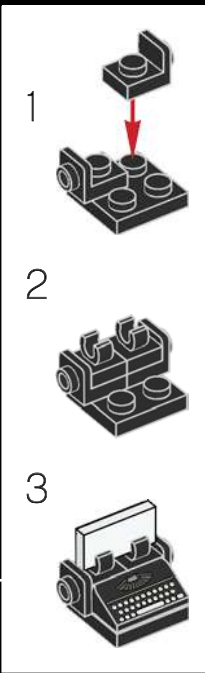
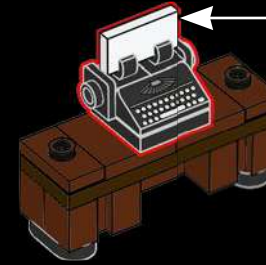

239

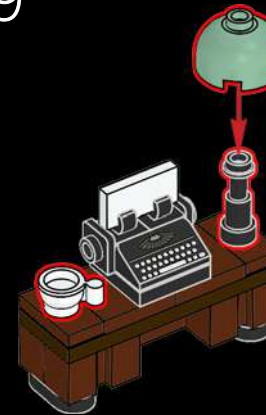

240





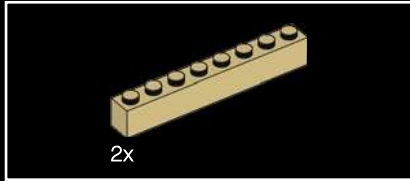
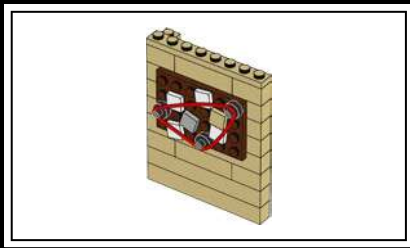

241

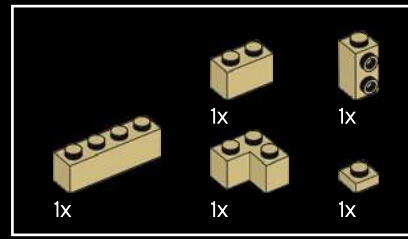
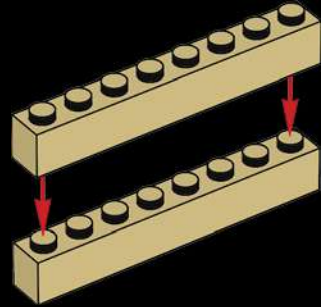

242

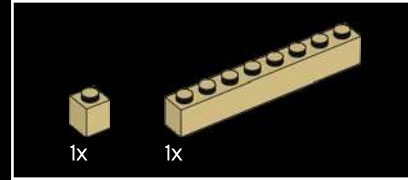
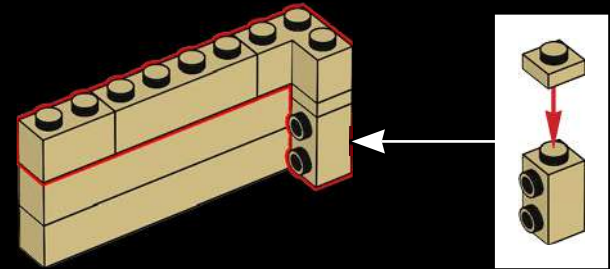

243

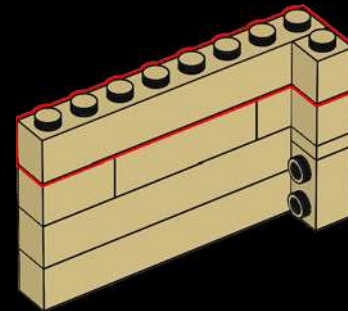

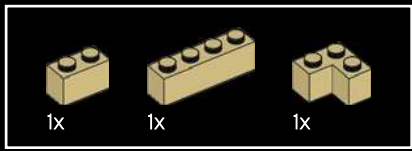

244

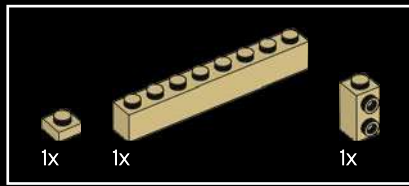
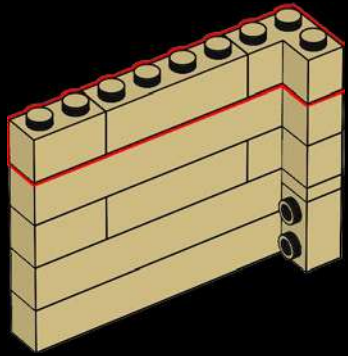

245

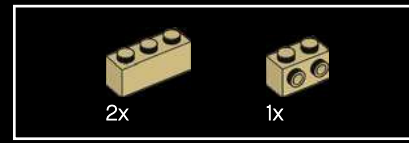
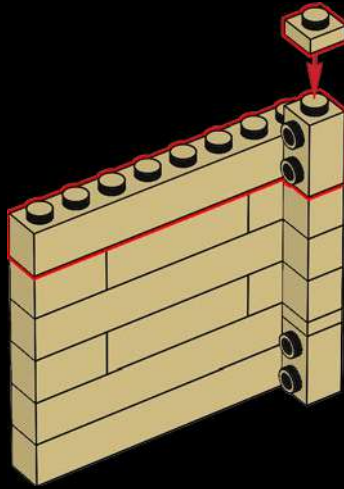

246

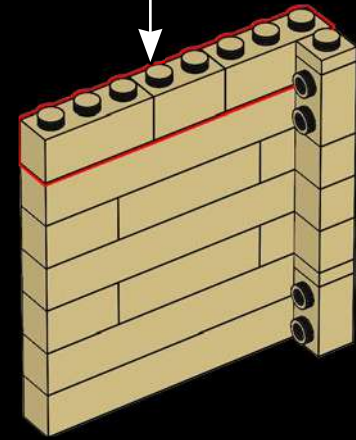
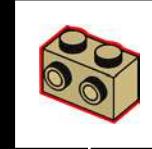

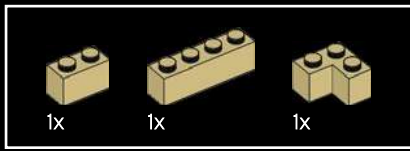

247

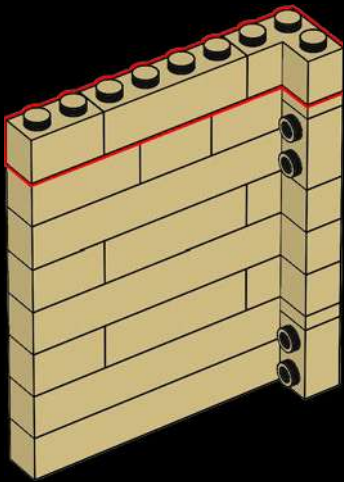

248

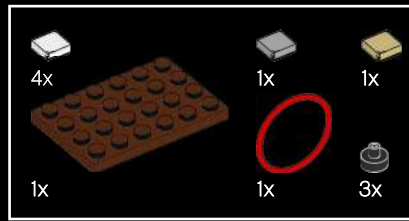
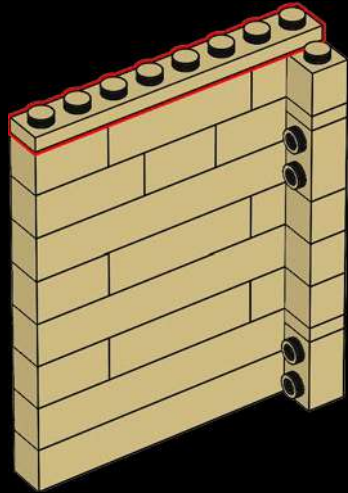

249

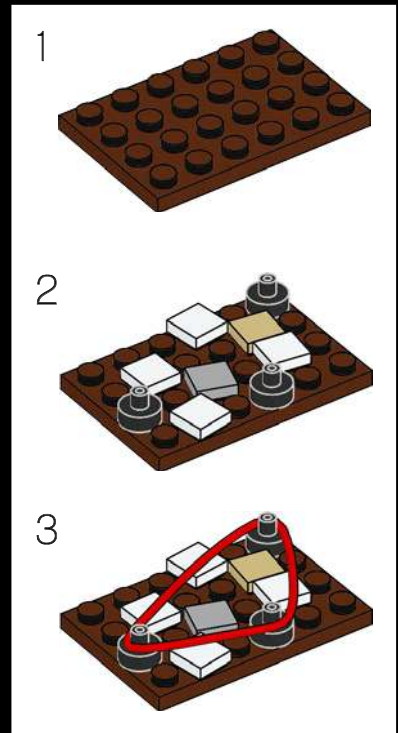
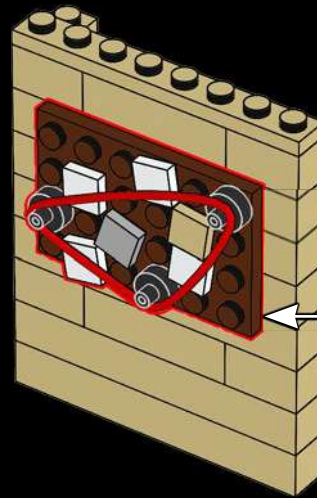

250

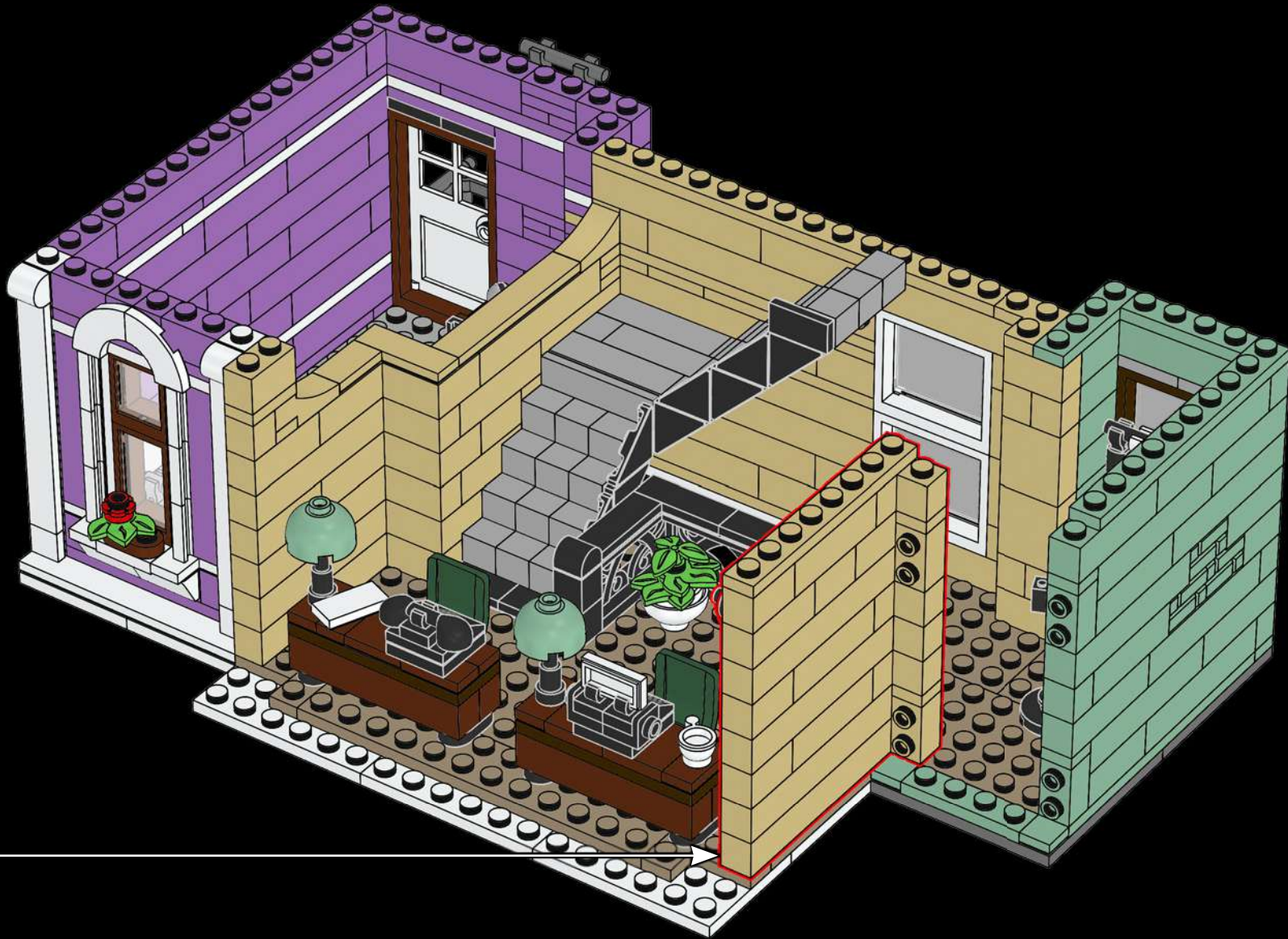

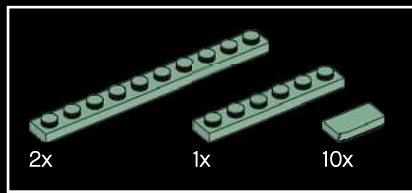

251

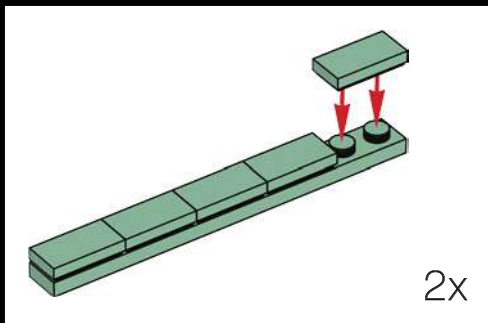
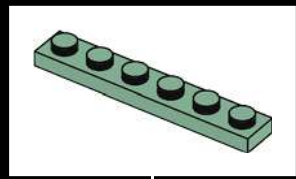
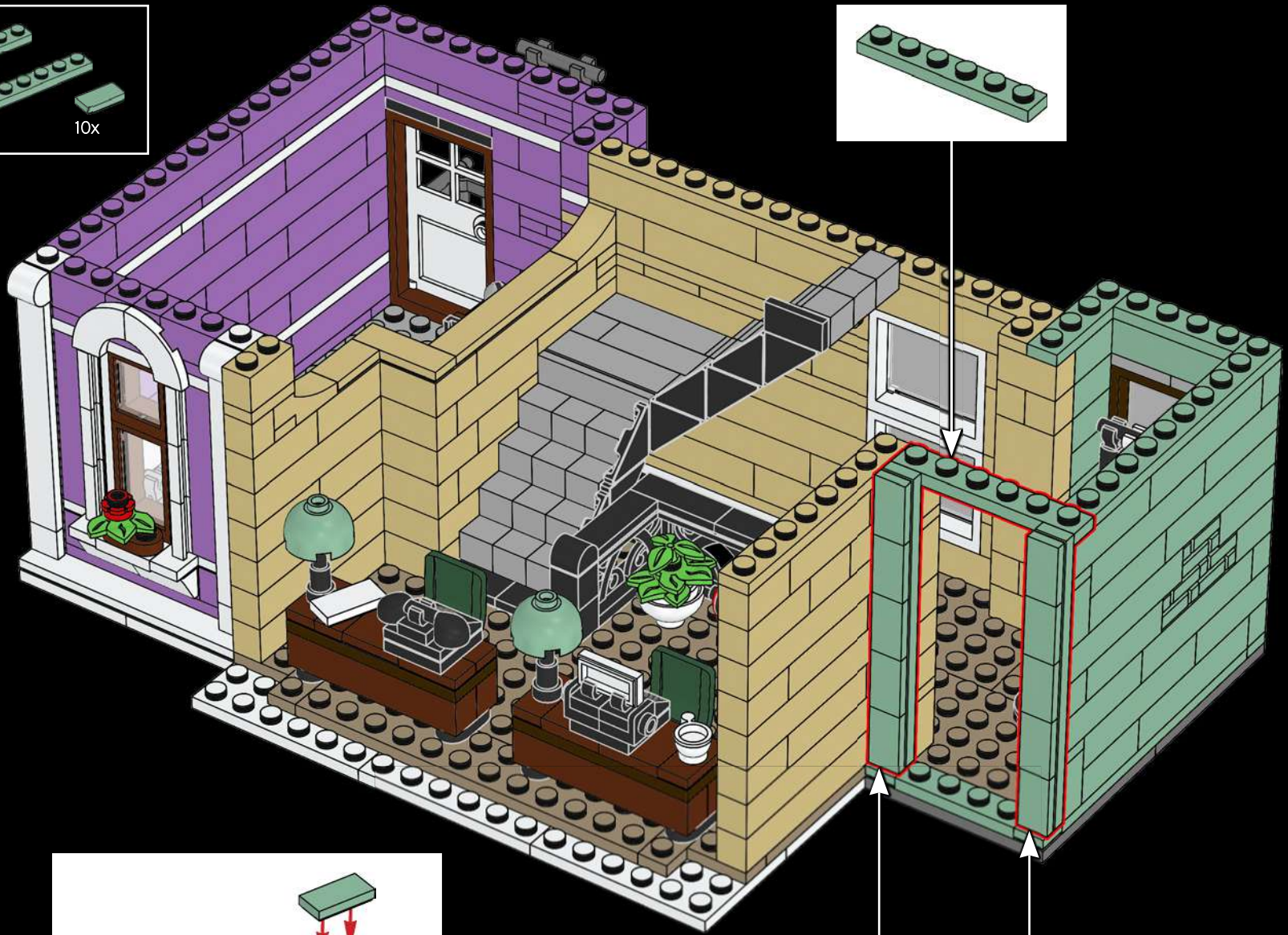



252

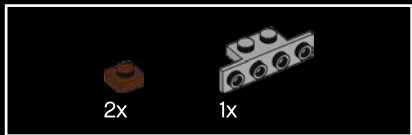
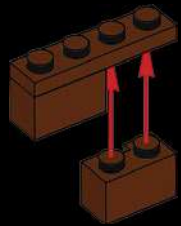

253

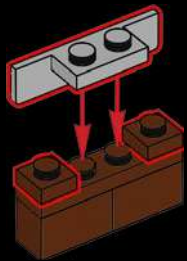

254

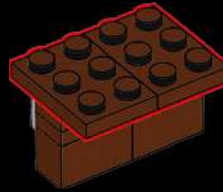

255

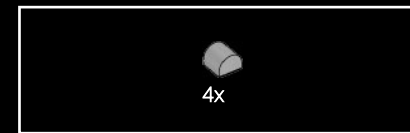
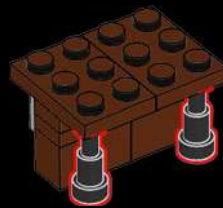

256

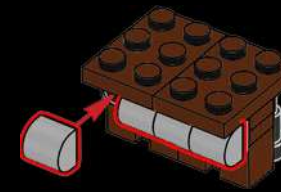

257



258

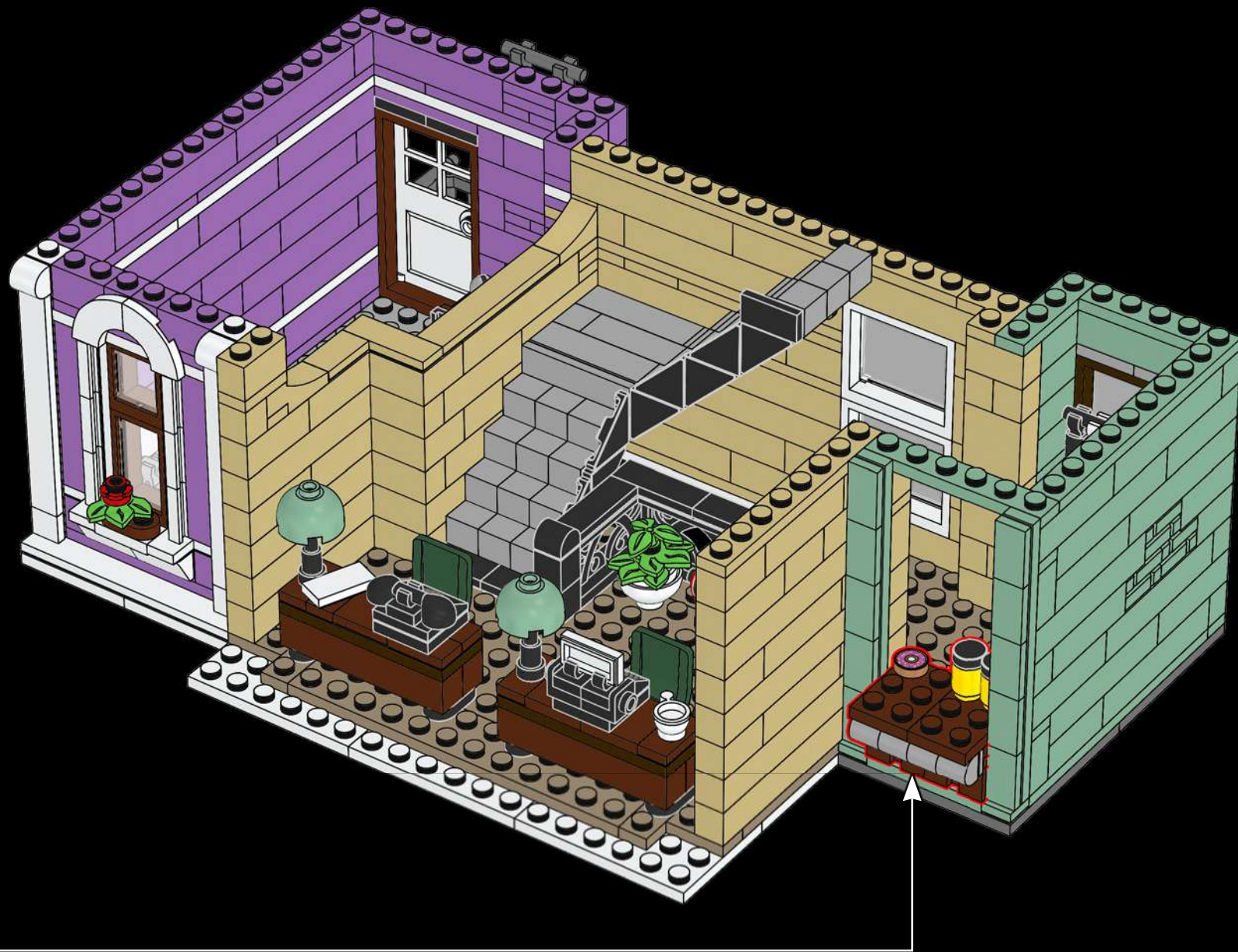

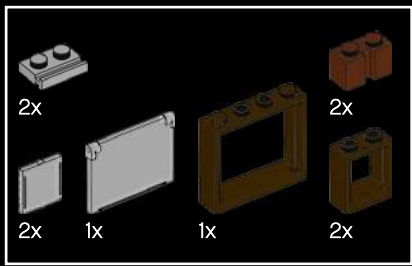

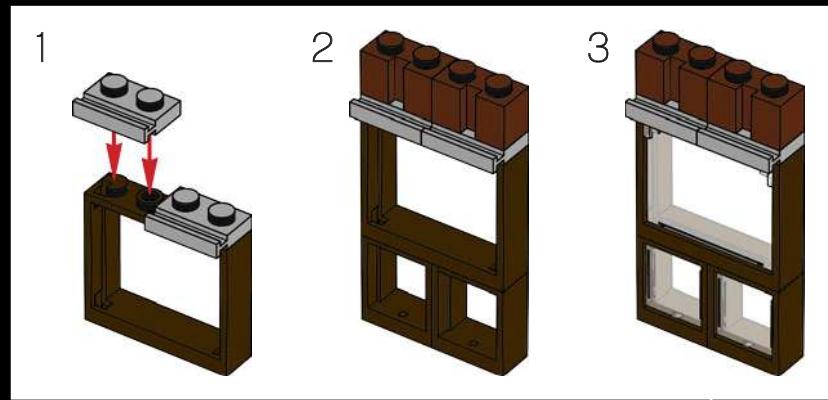

259





- 1x 
- 2x 
- 1x 
- 1x 

260

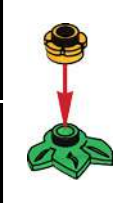

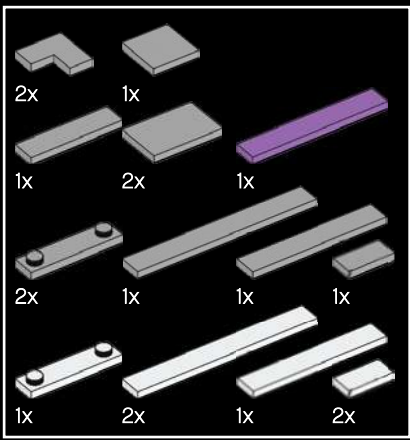

261





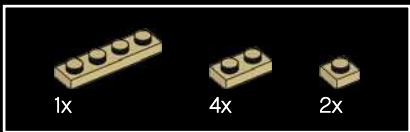

262



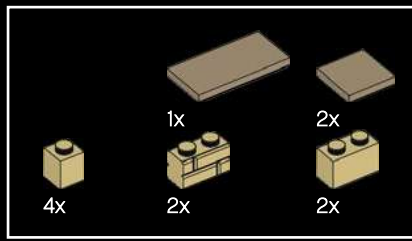

263





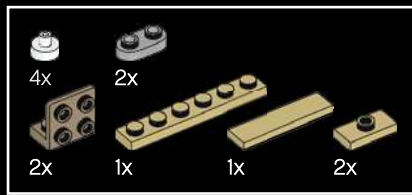

265

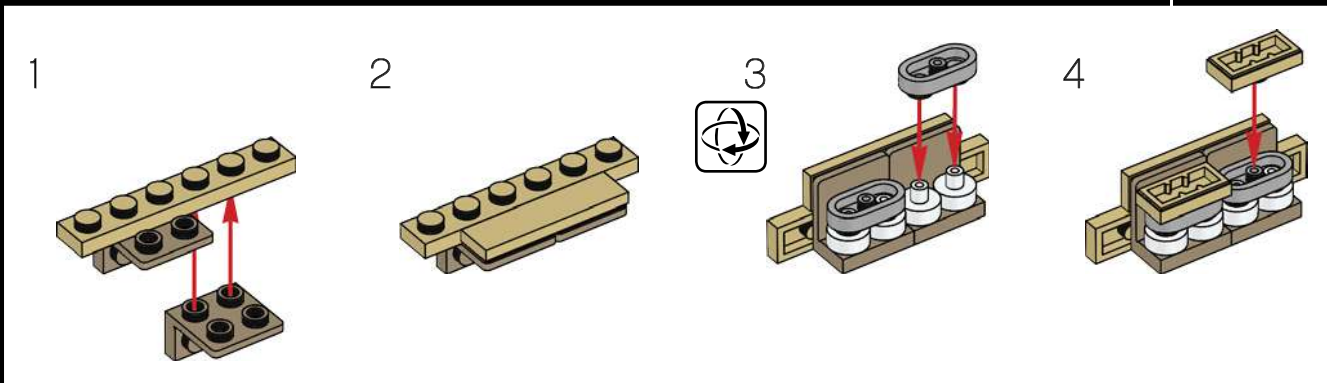

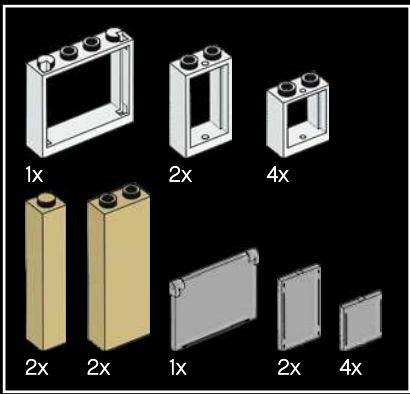

266

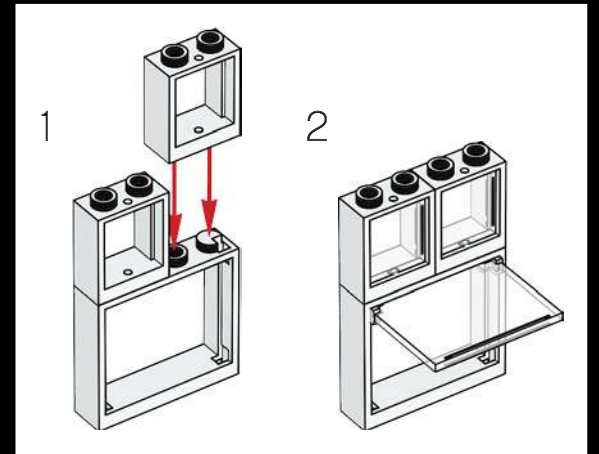
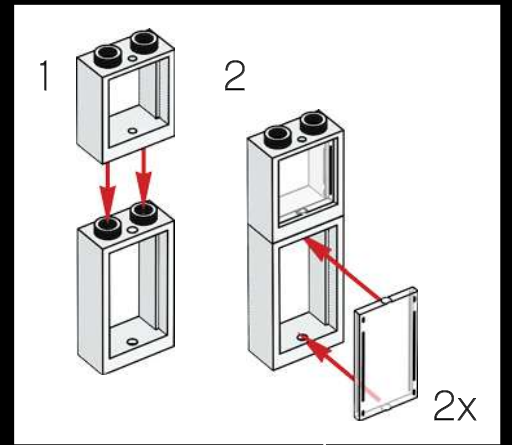



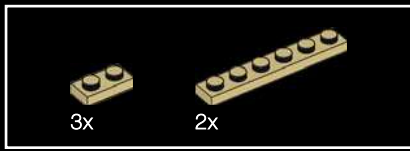

267

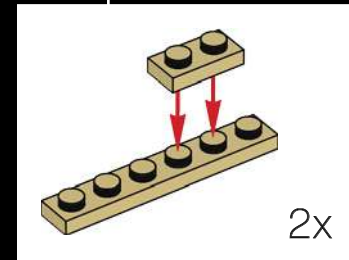

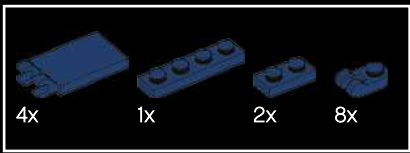

268

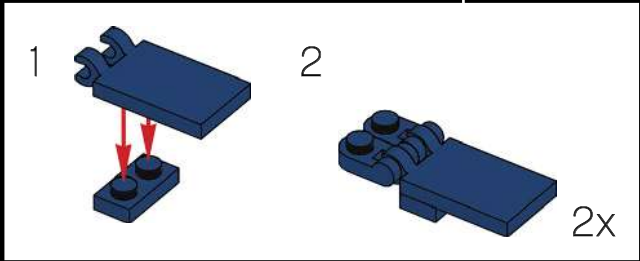
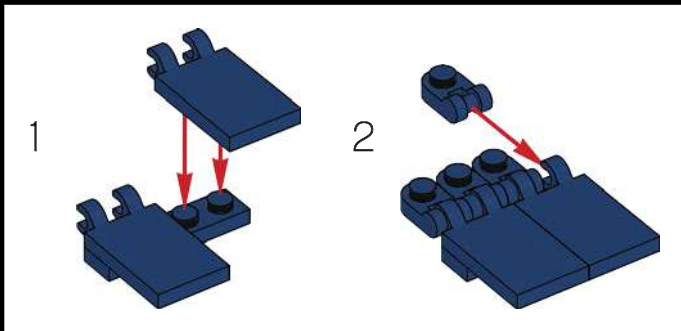

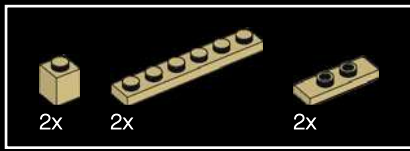

269

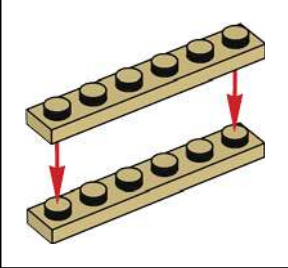

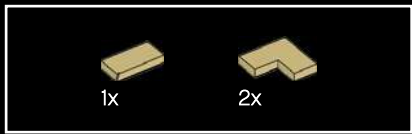

270



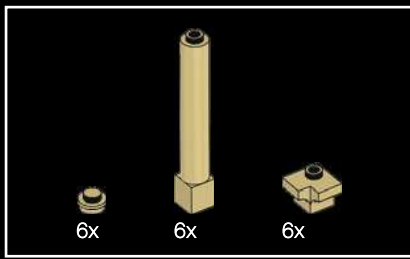

271

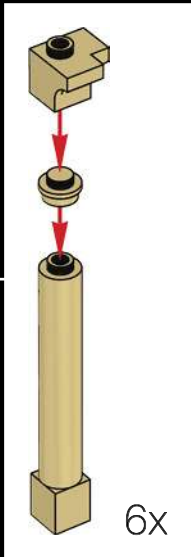

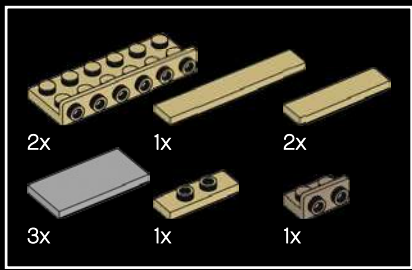

272

1

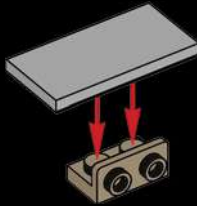

2

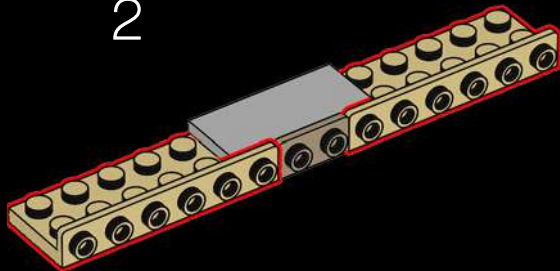

3

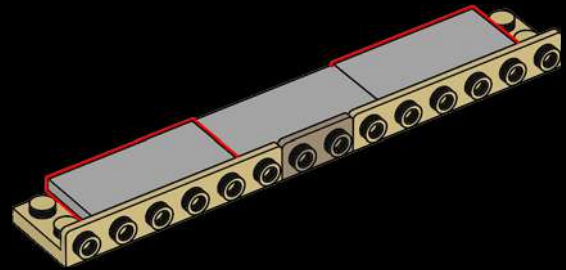

4

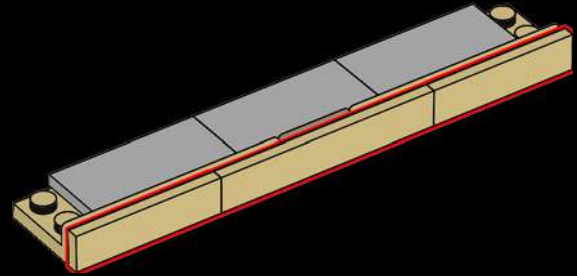

5

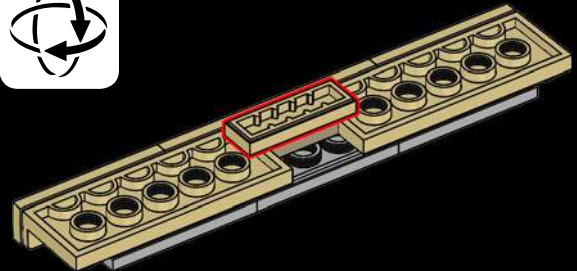

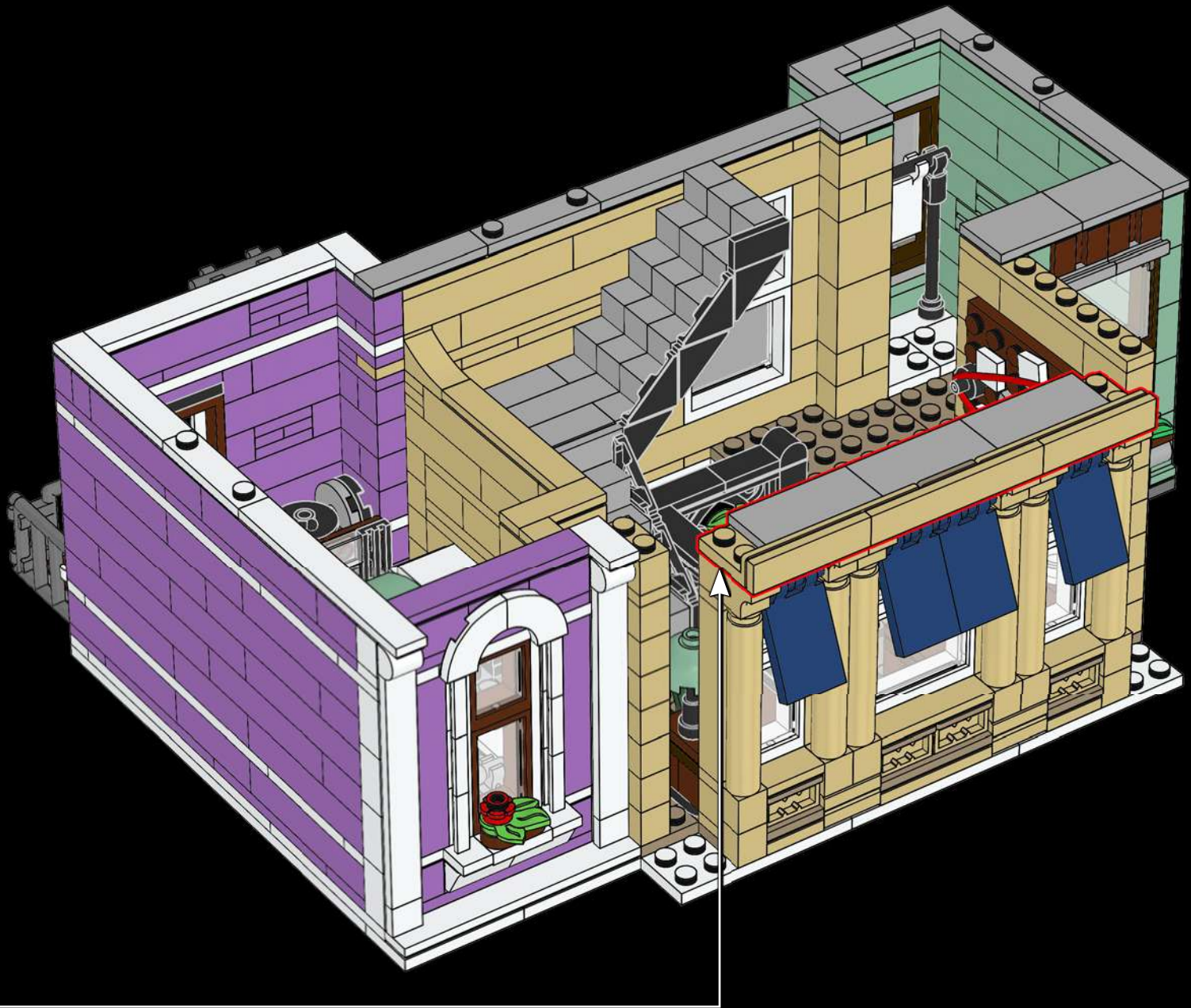

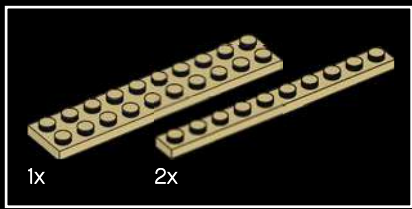

273

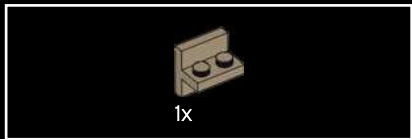
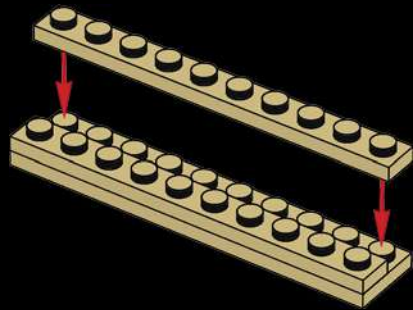

274

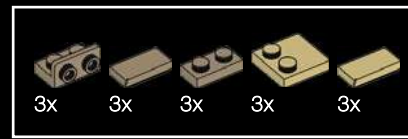
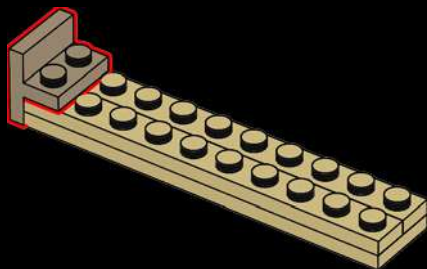

275

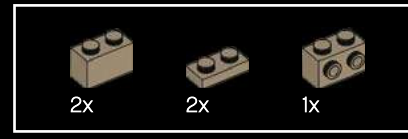
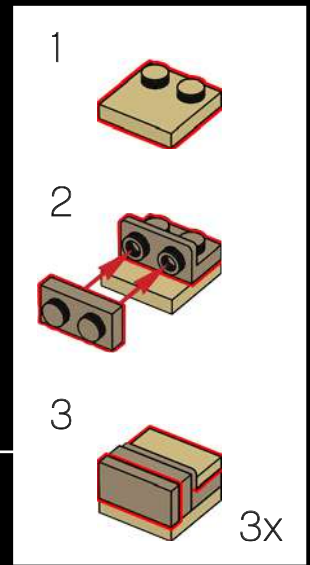
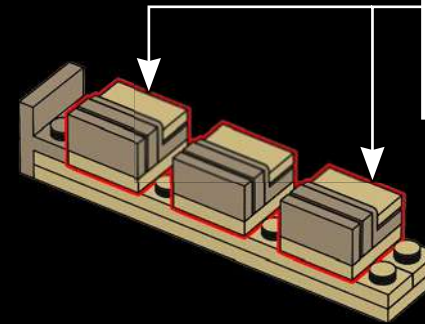

276

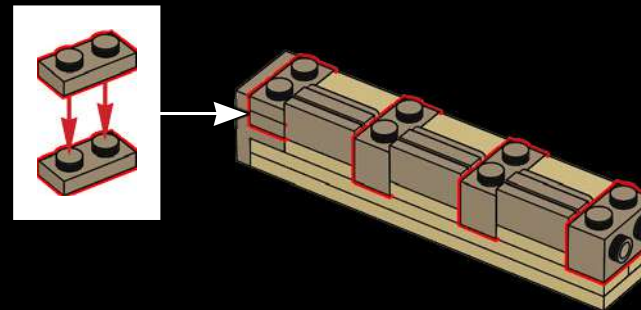





277

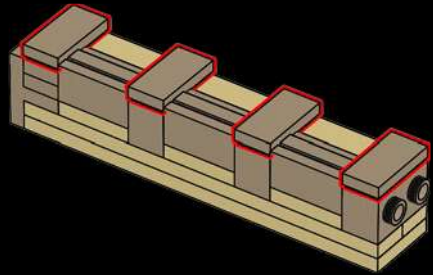

278



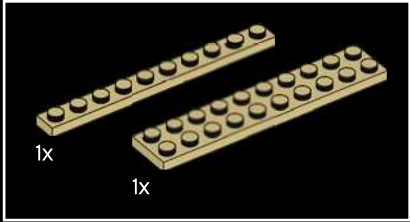
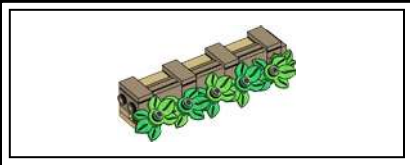

279

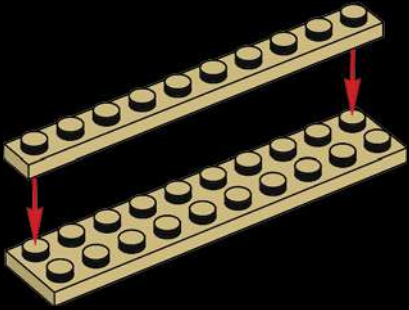

280

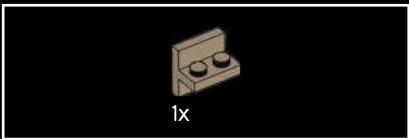
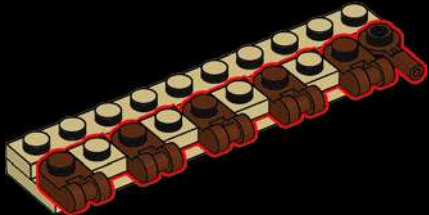

281

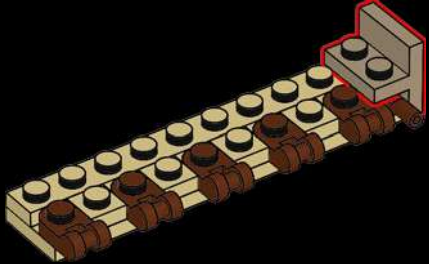

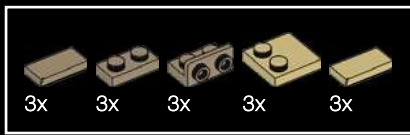

282

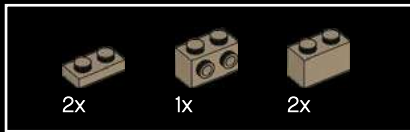
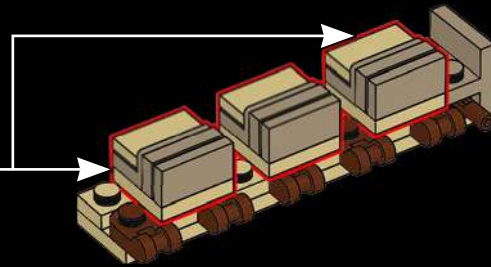
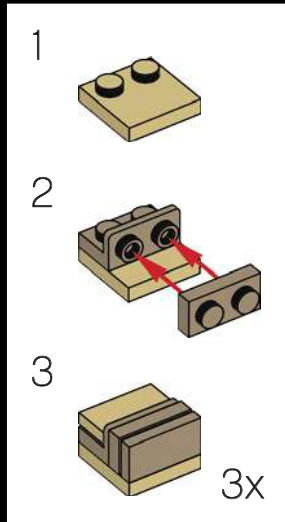

283

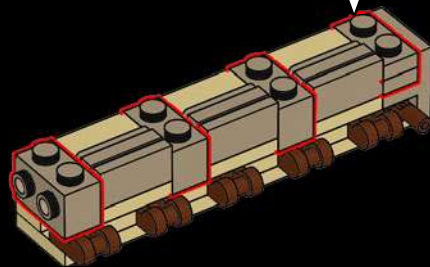
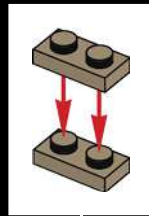

284

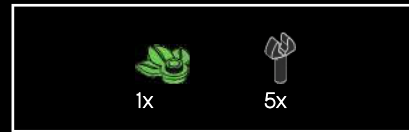
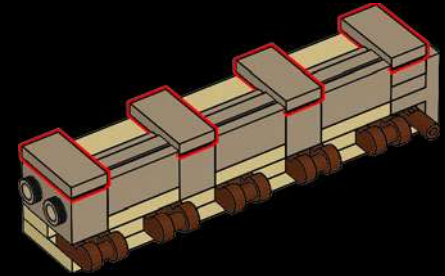

285

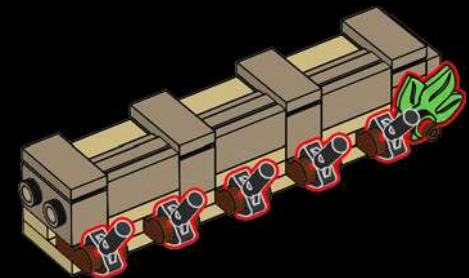

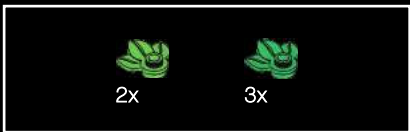

286

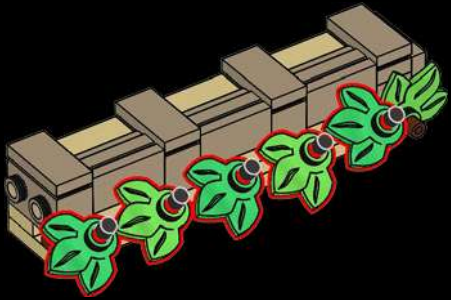

287

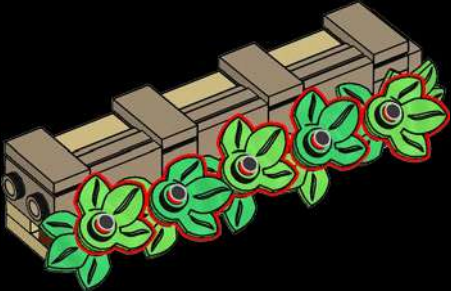

288



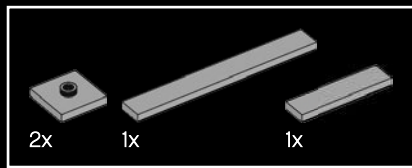

289



290

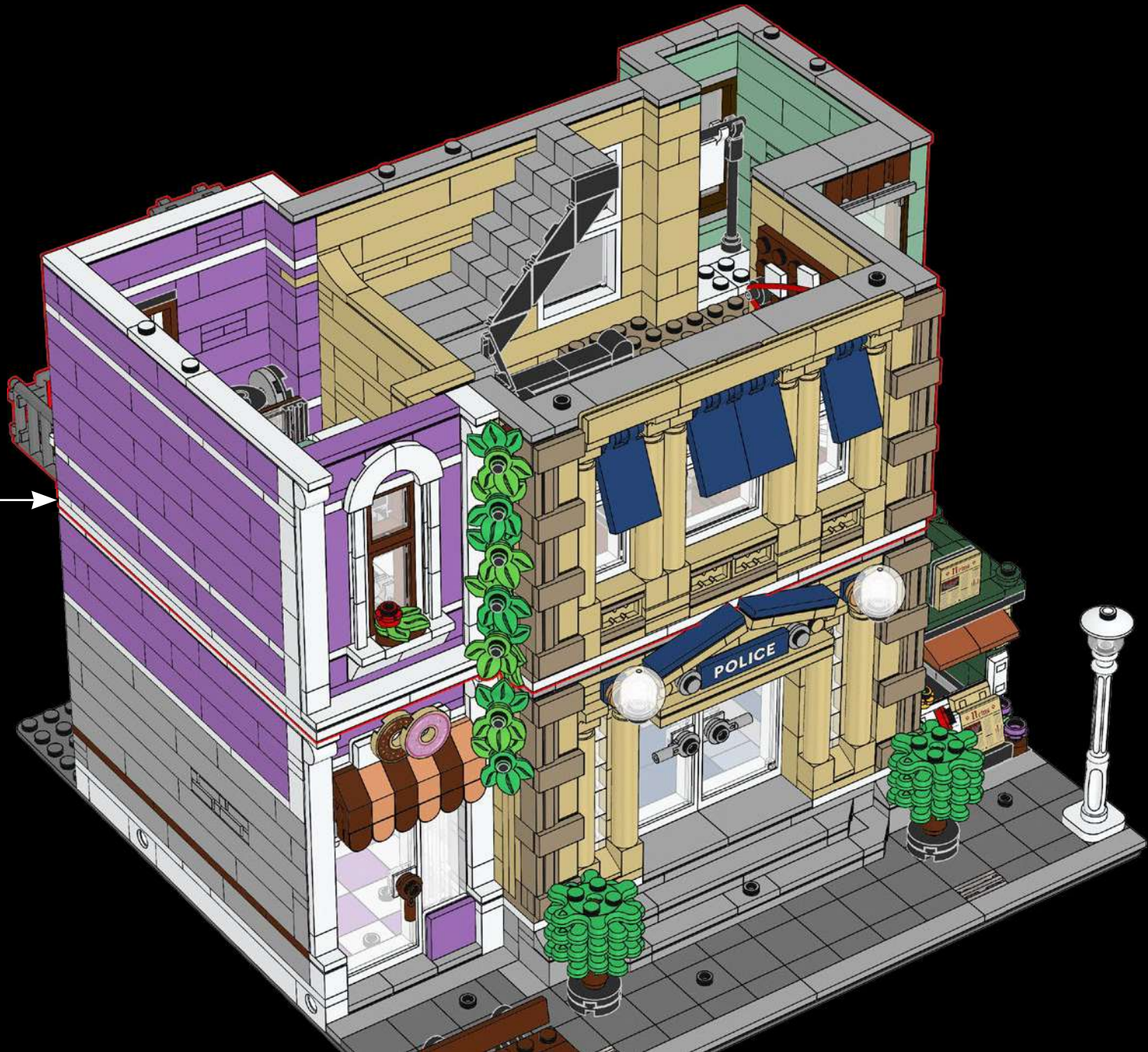

206

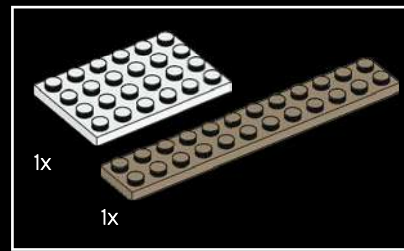
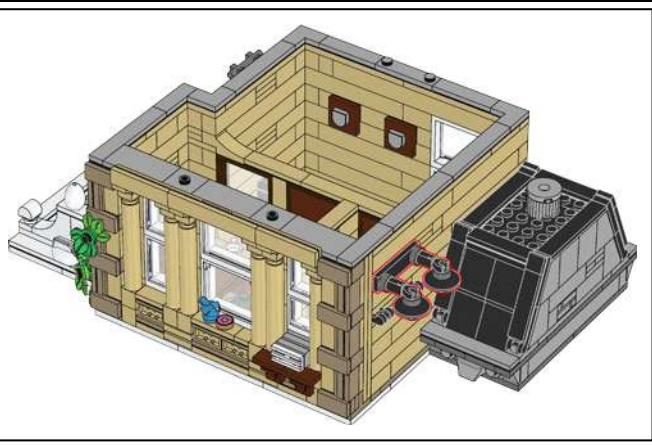
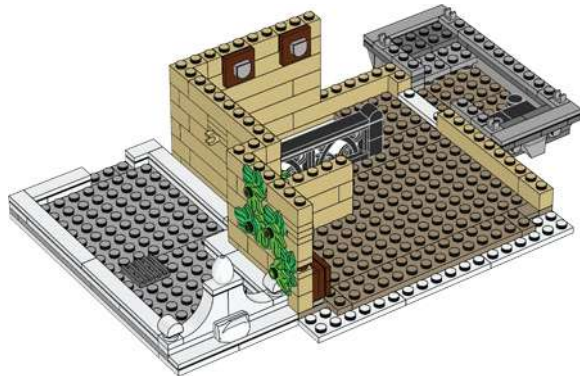
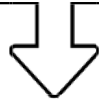
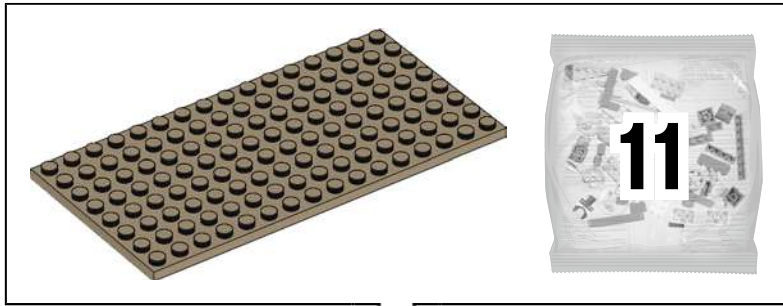

291

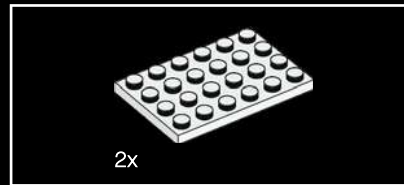
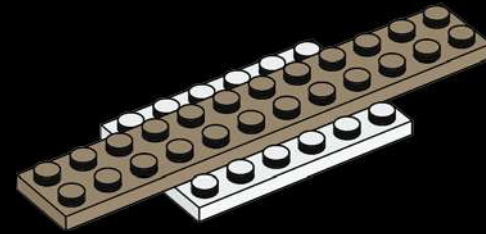

292

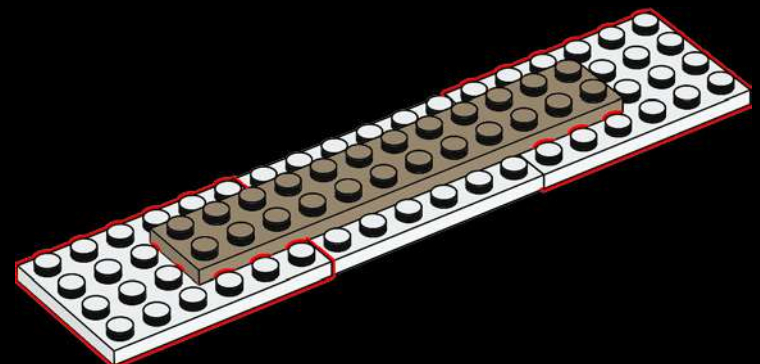



293

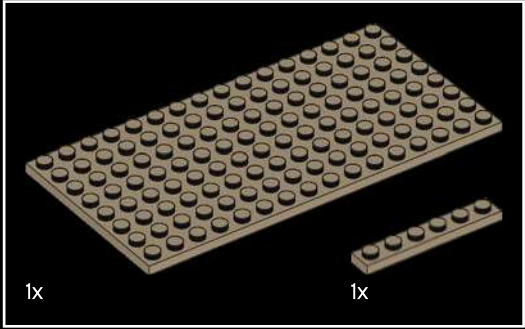
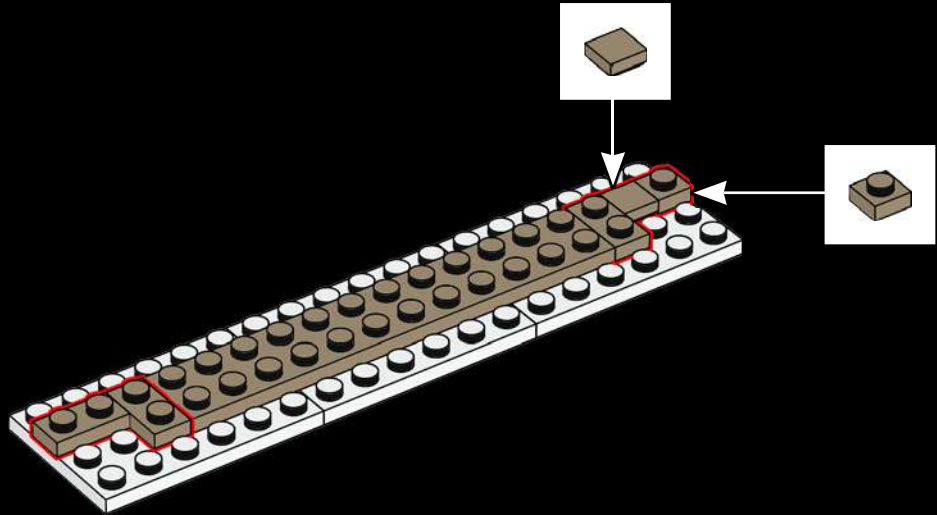

294

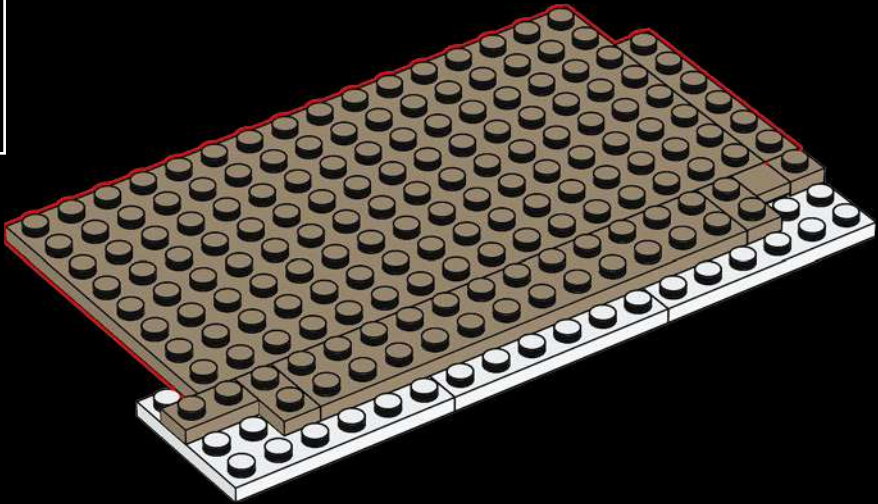



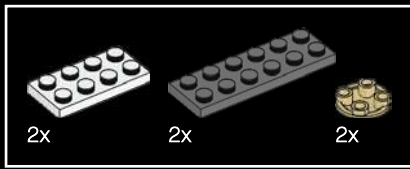

295

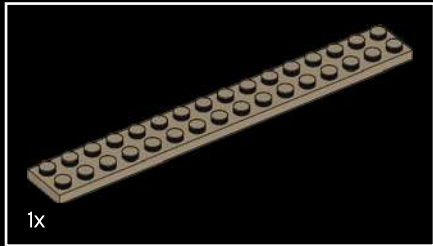
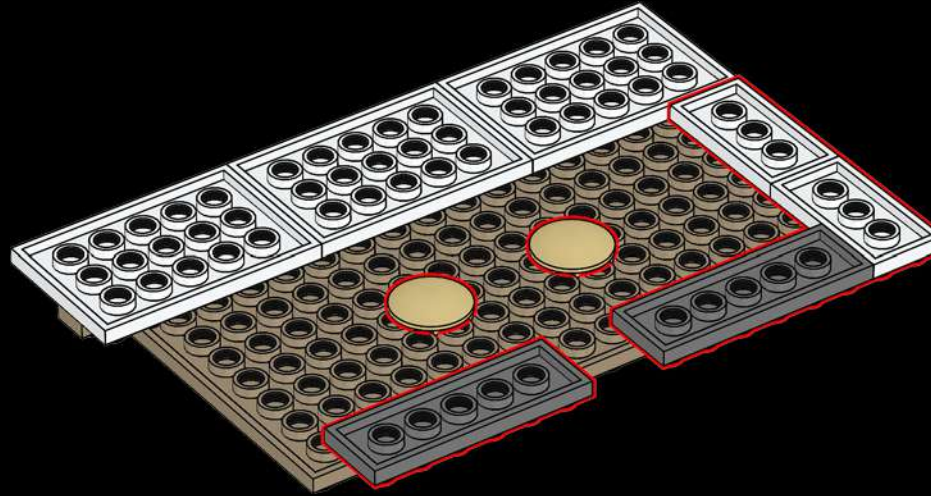

296

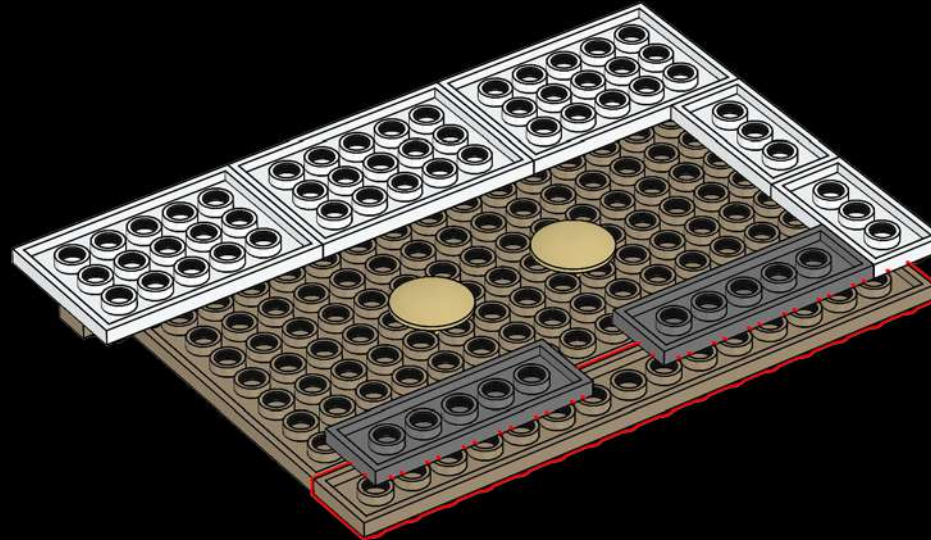

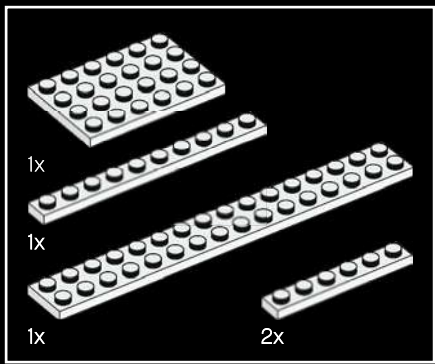

297

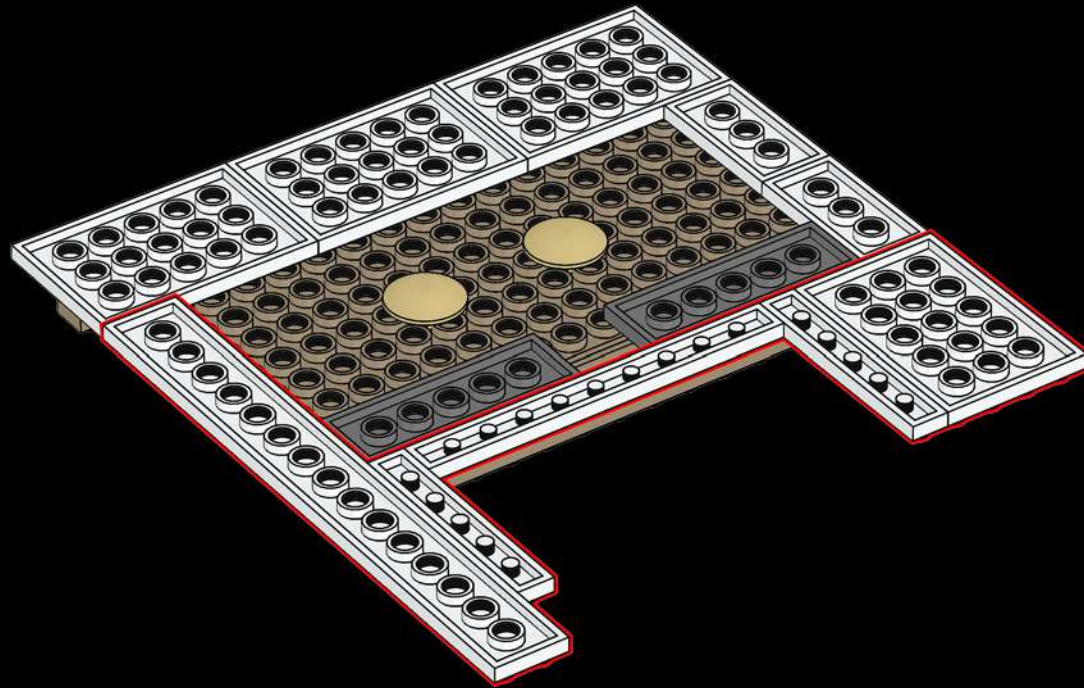

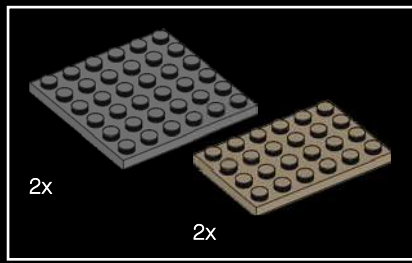

298

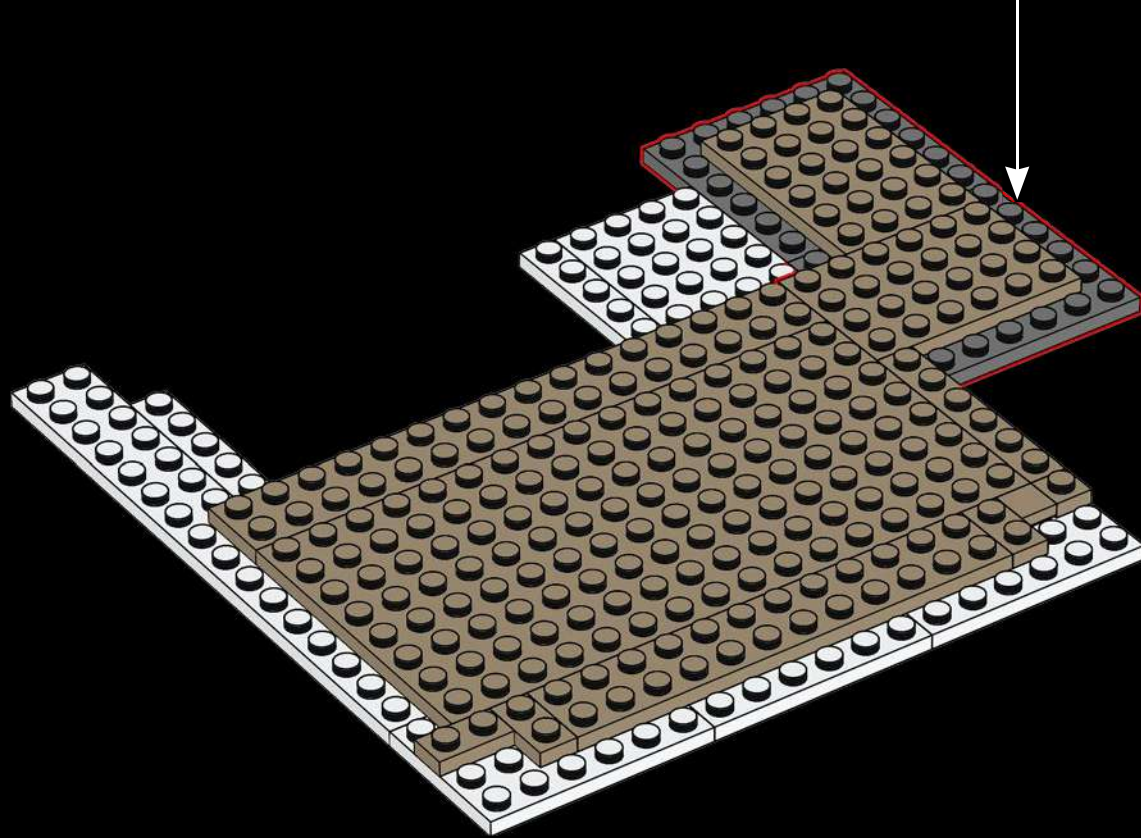
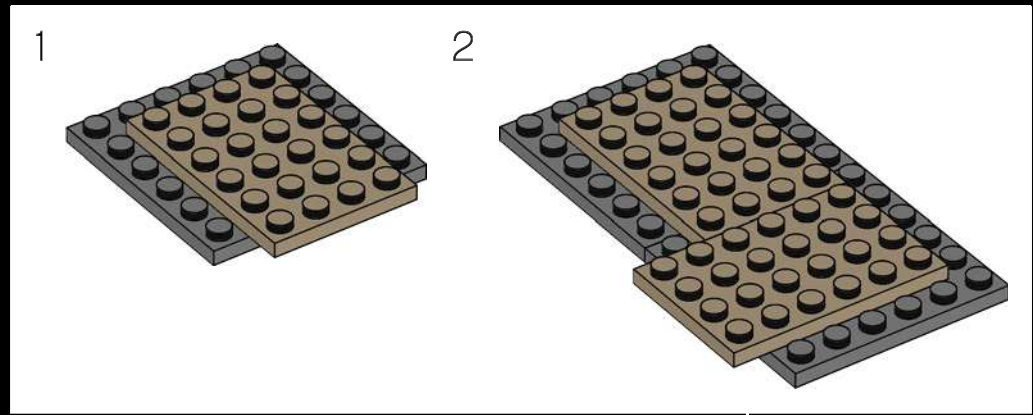

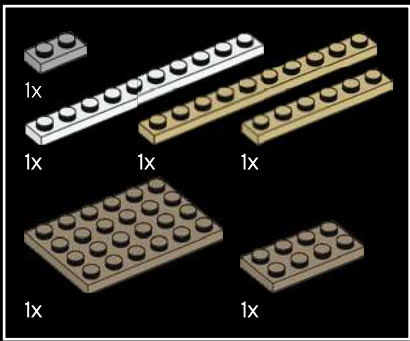

299

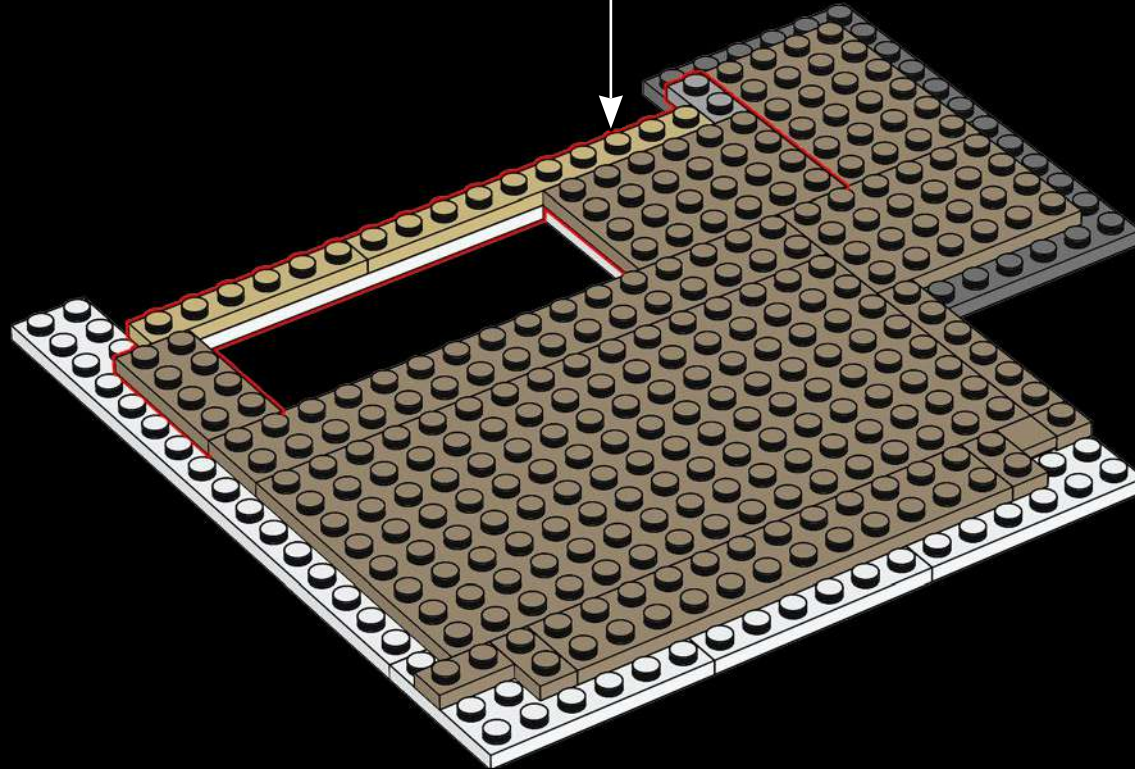
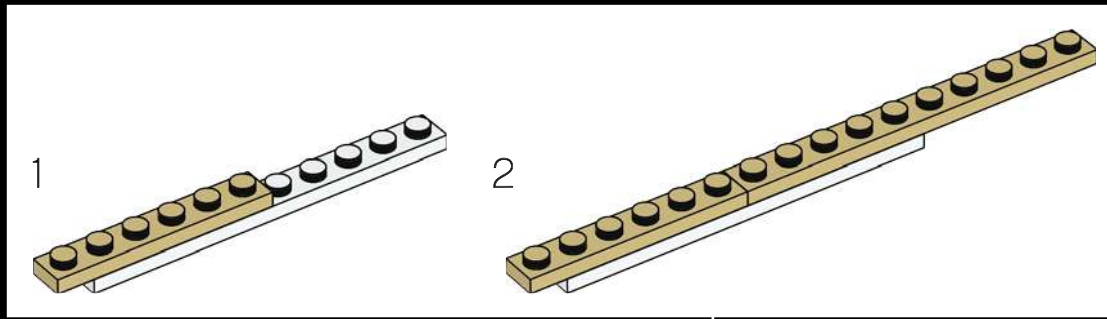

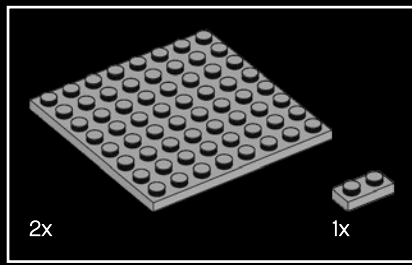

300

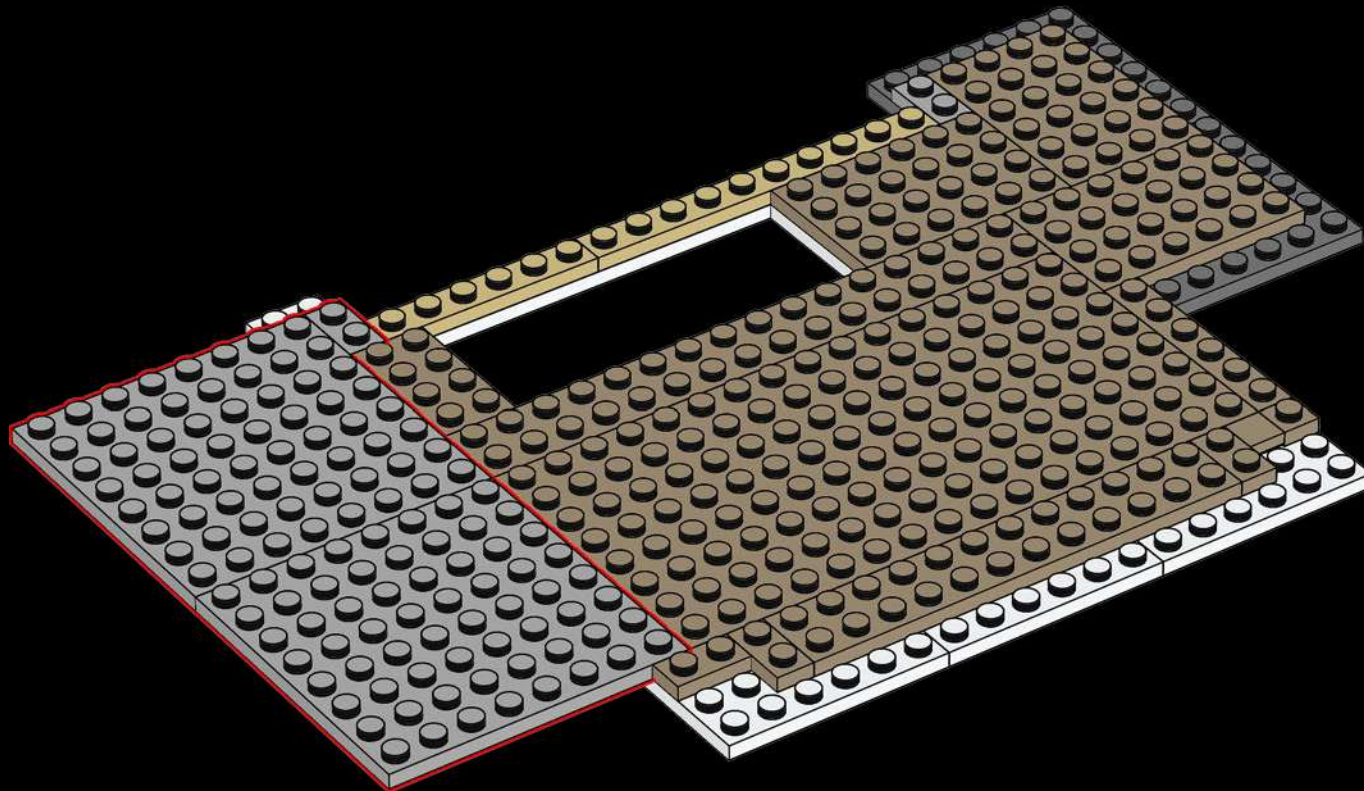



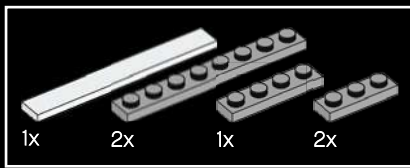

302

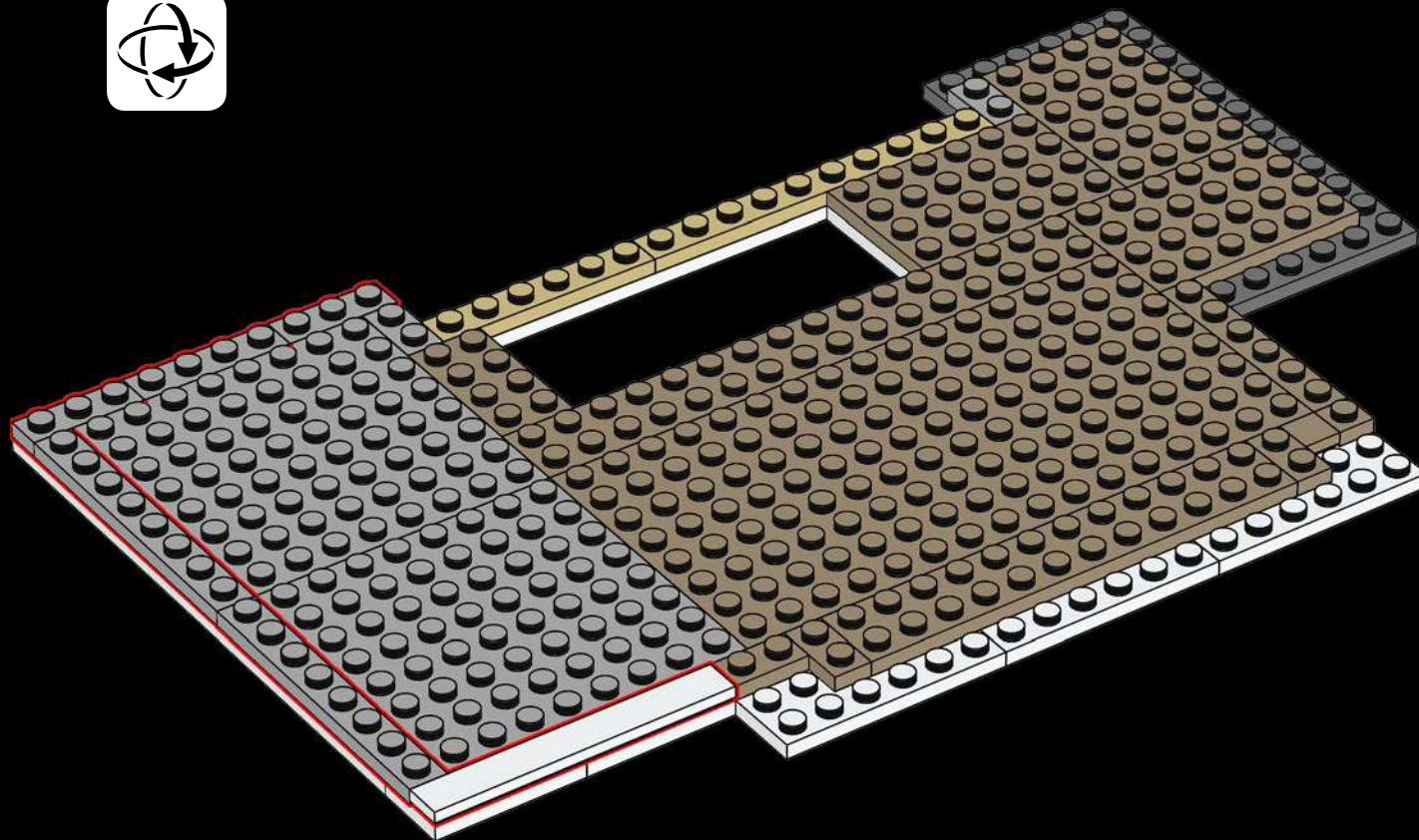

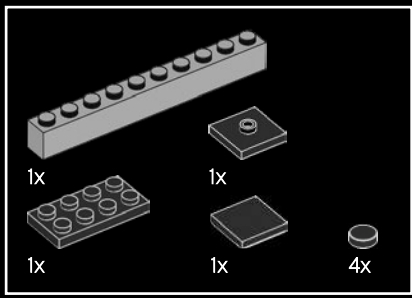

303

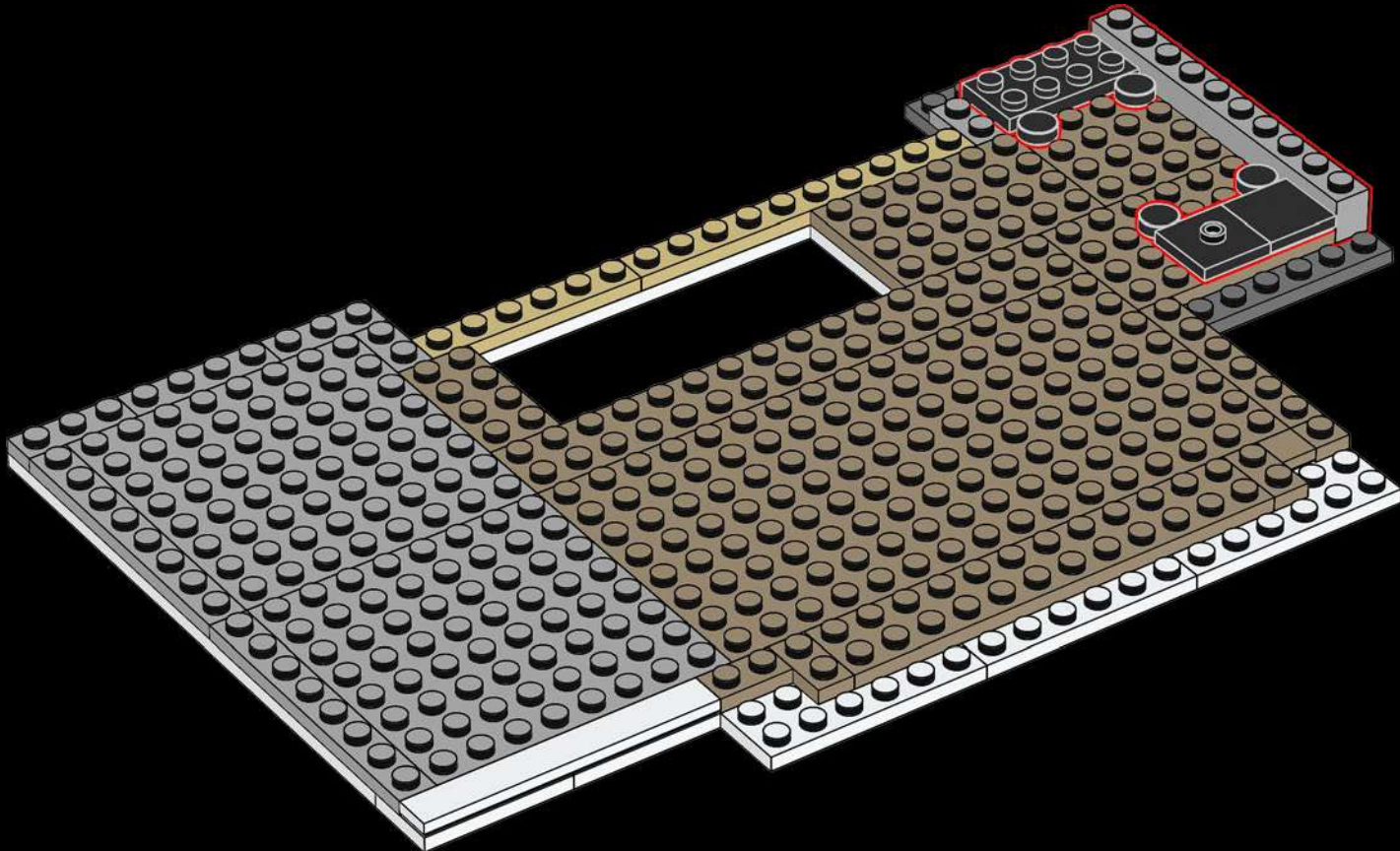





304

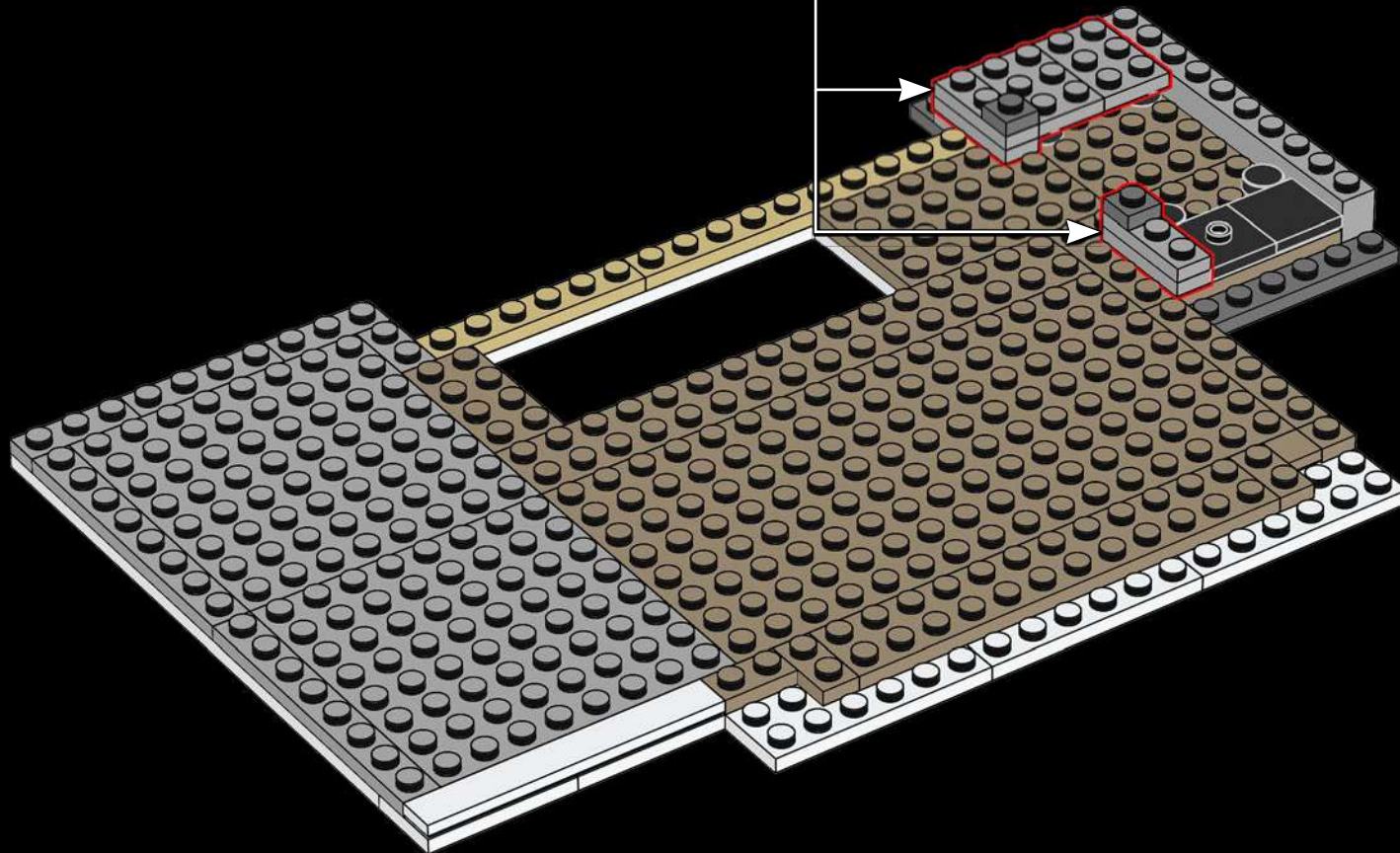
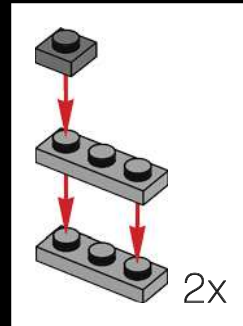

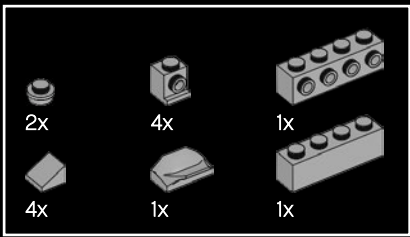

305

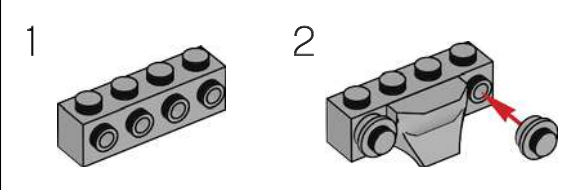
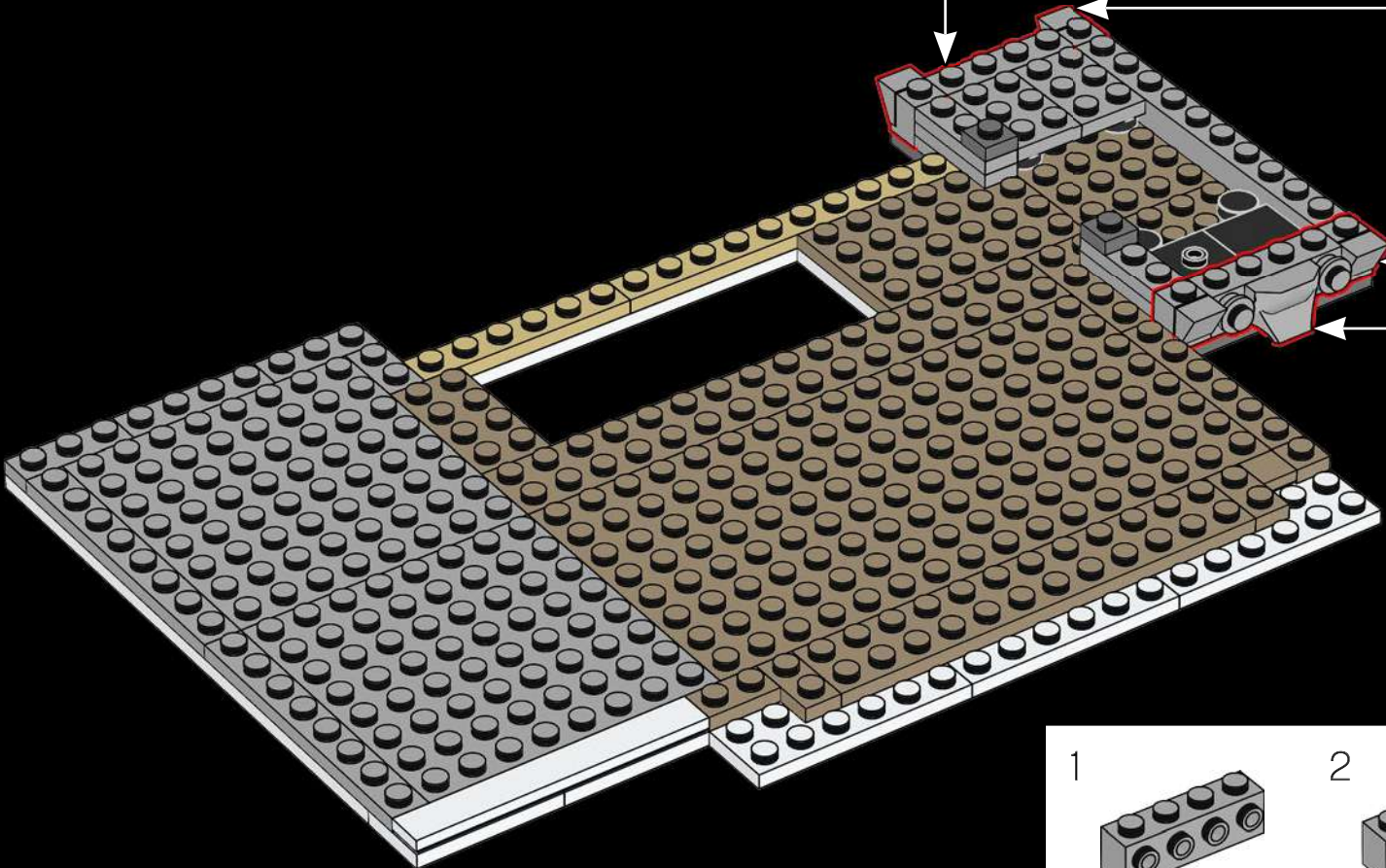
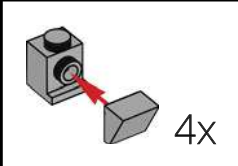
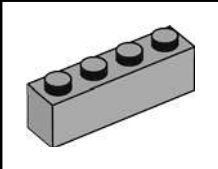

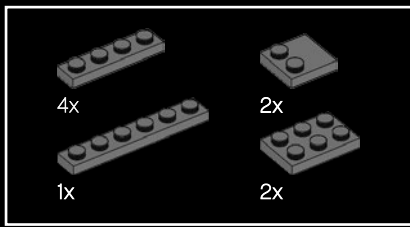

306

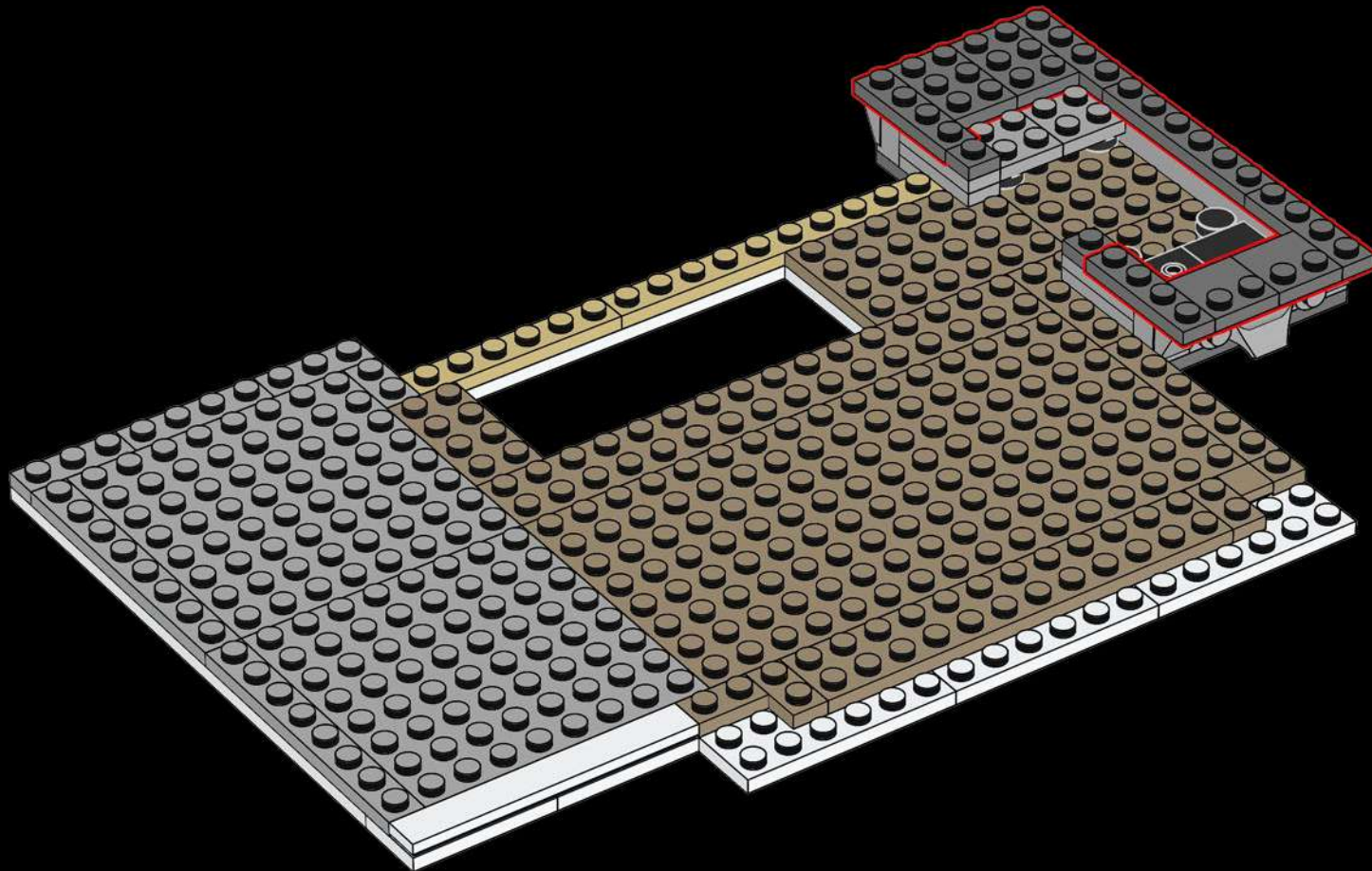

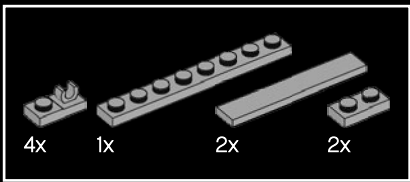

307

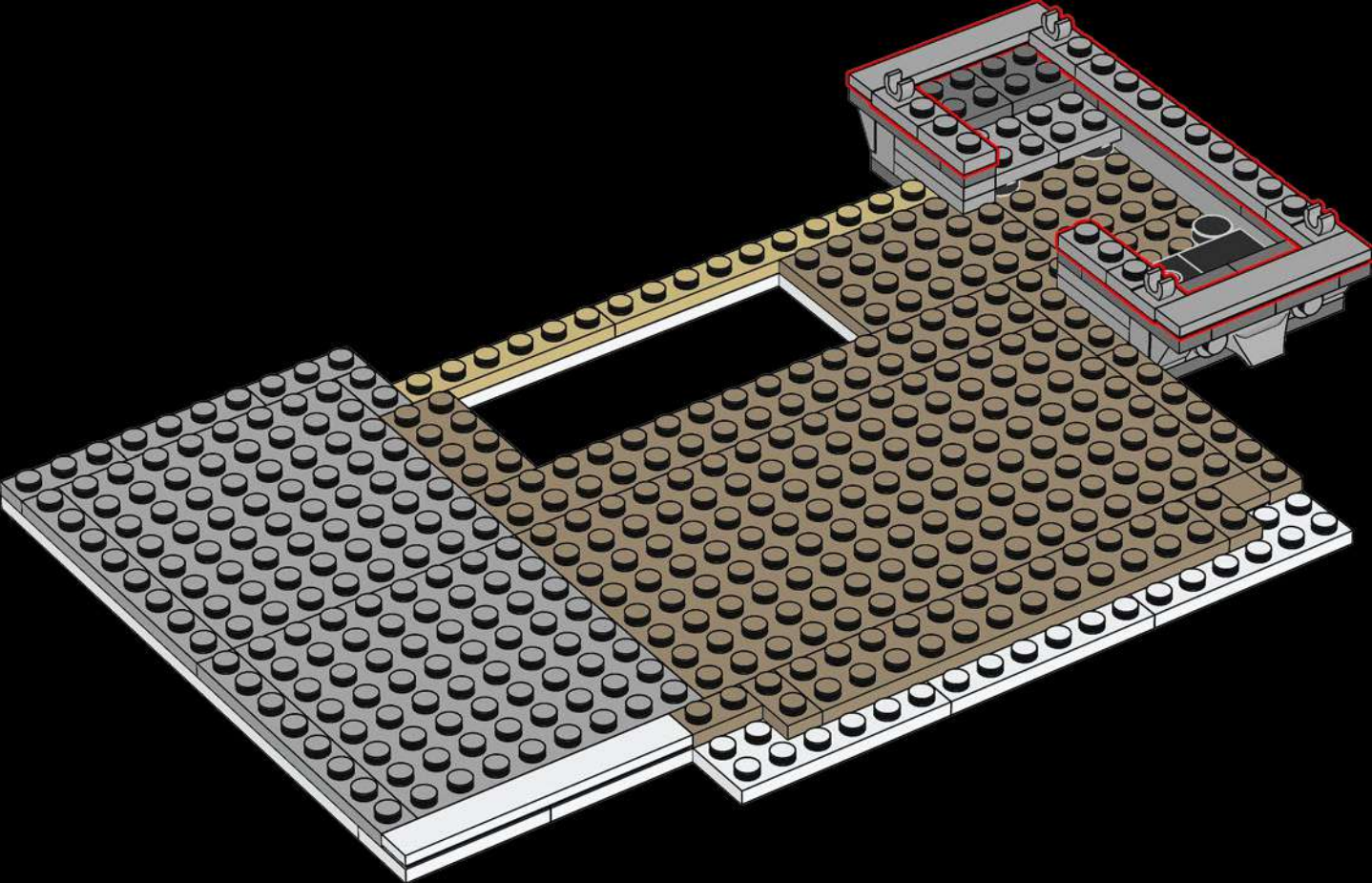

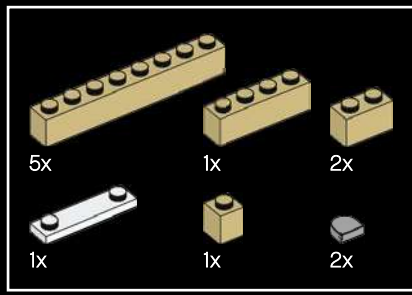

308

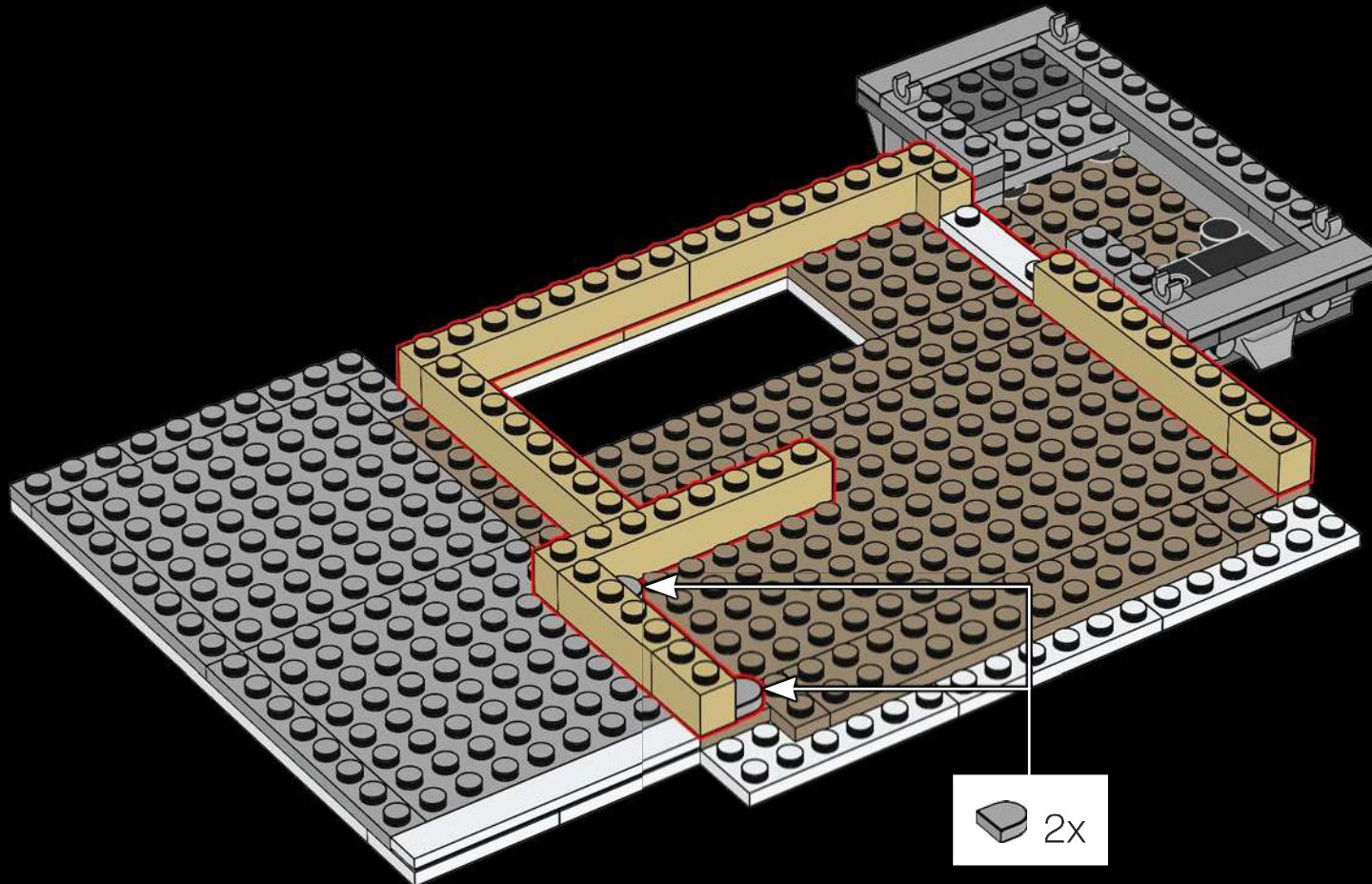







311

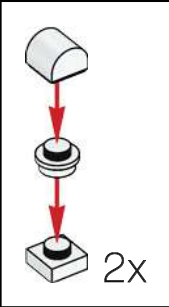
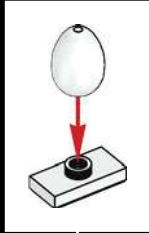
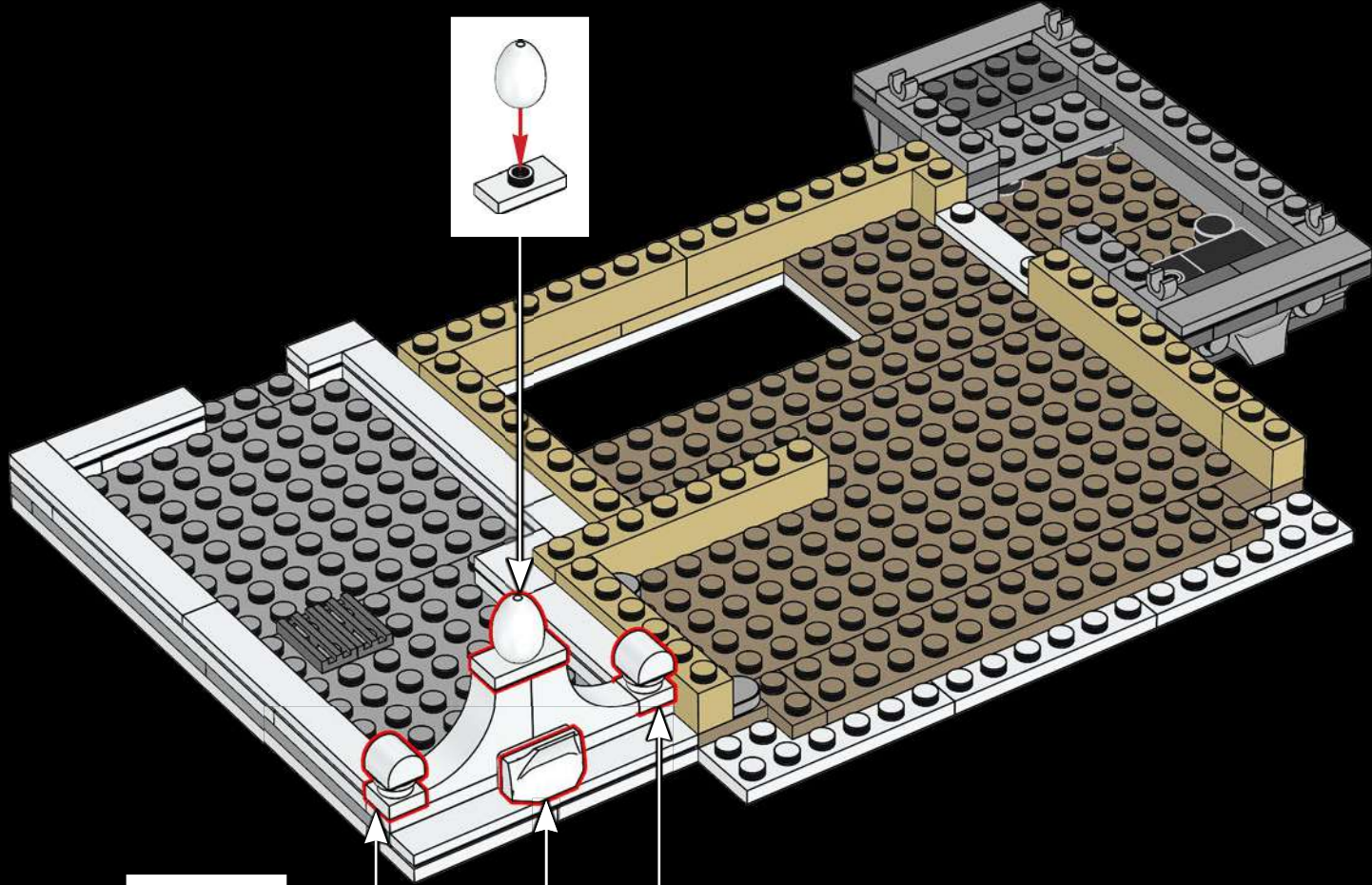



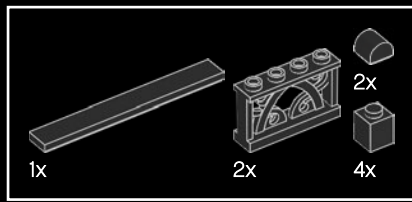

312

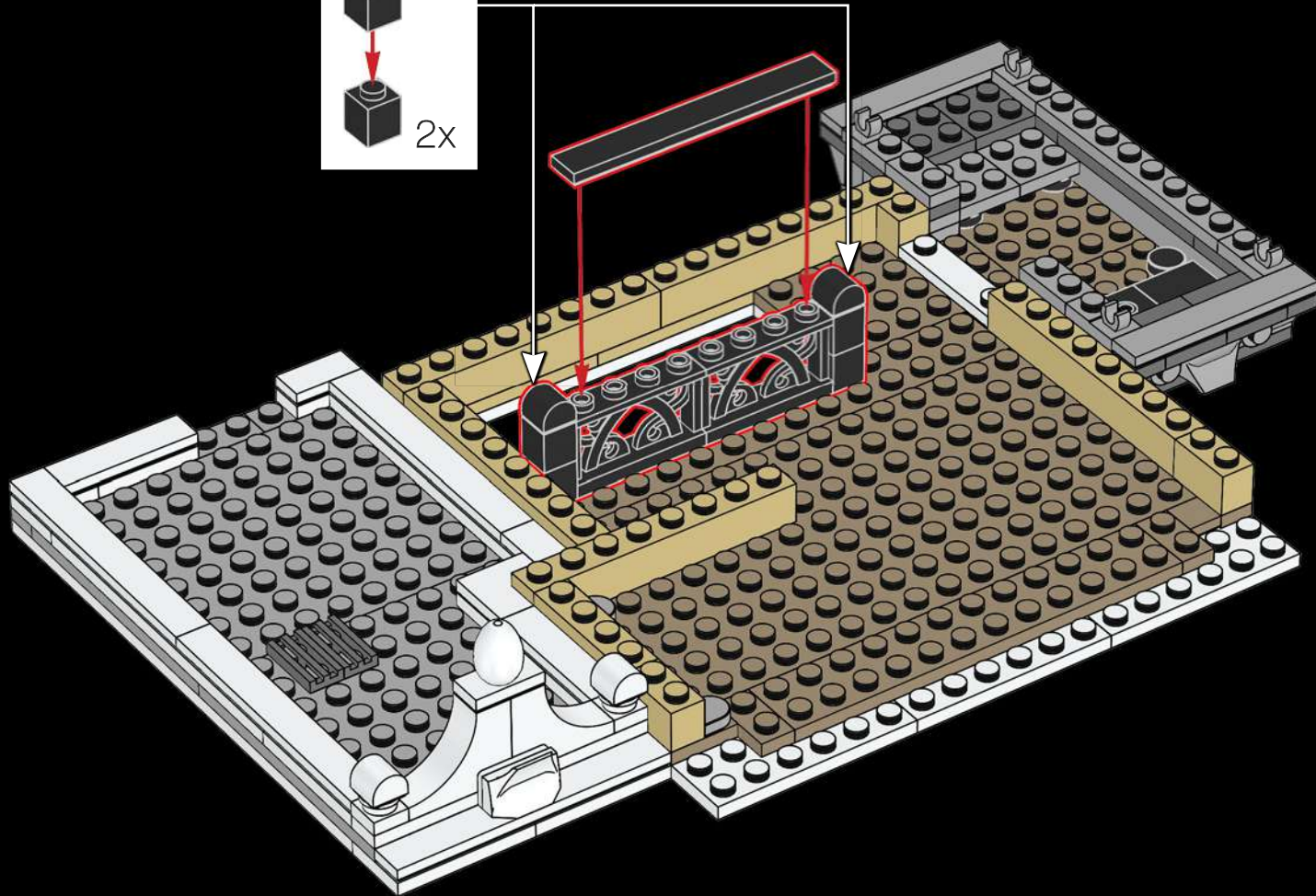
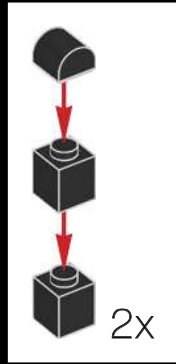



313

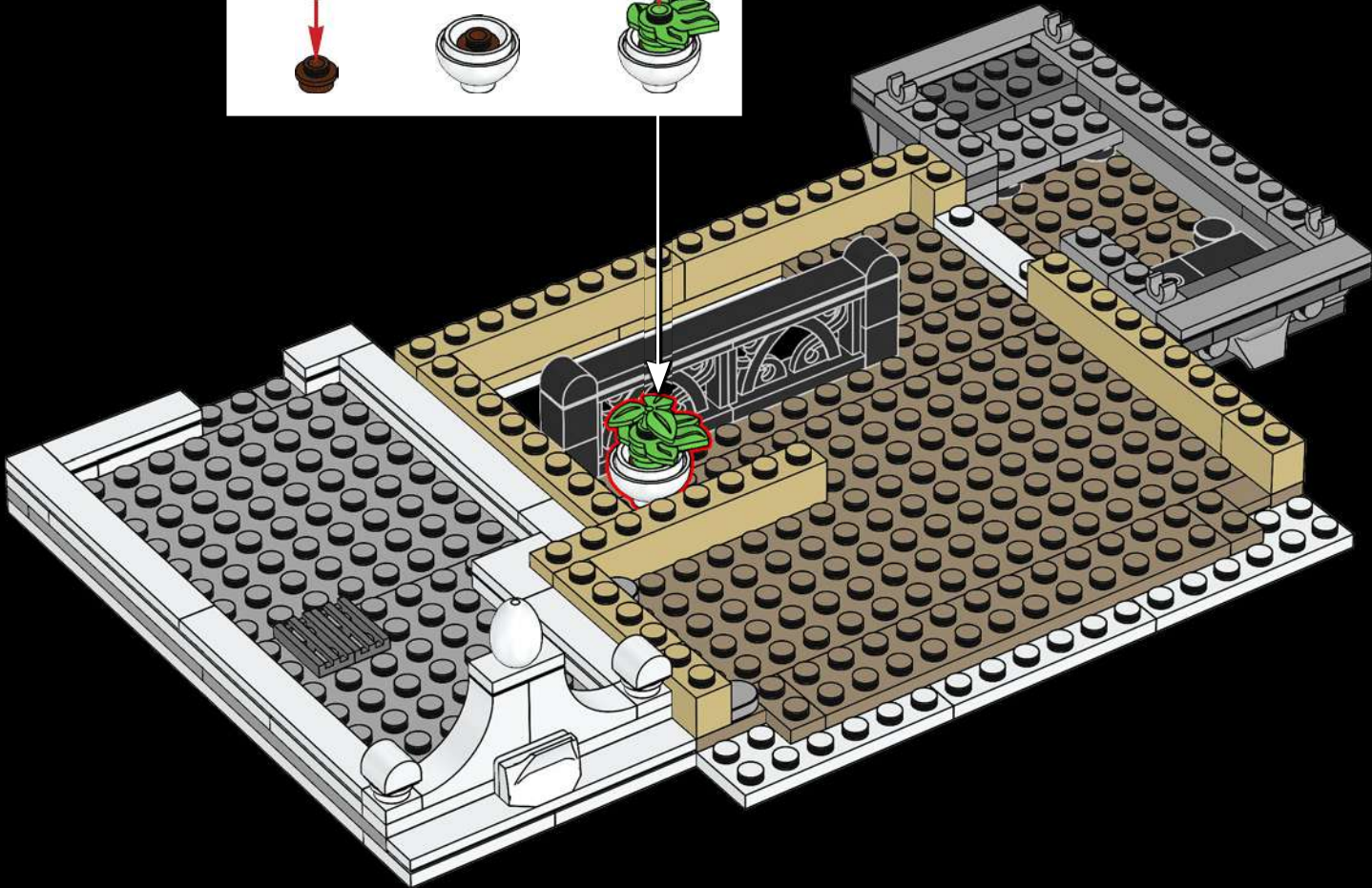
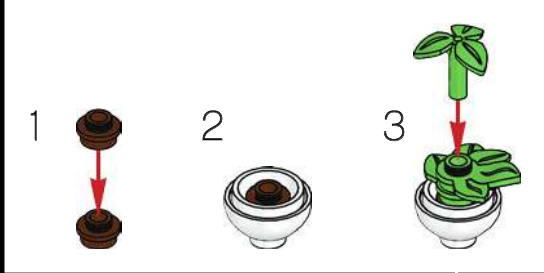

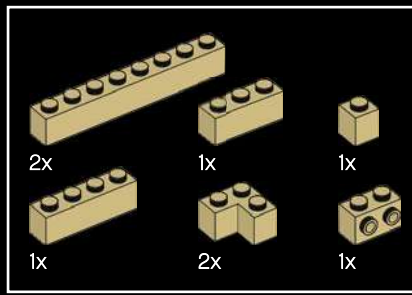

314

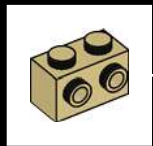
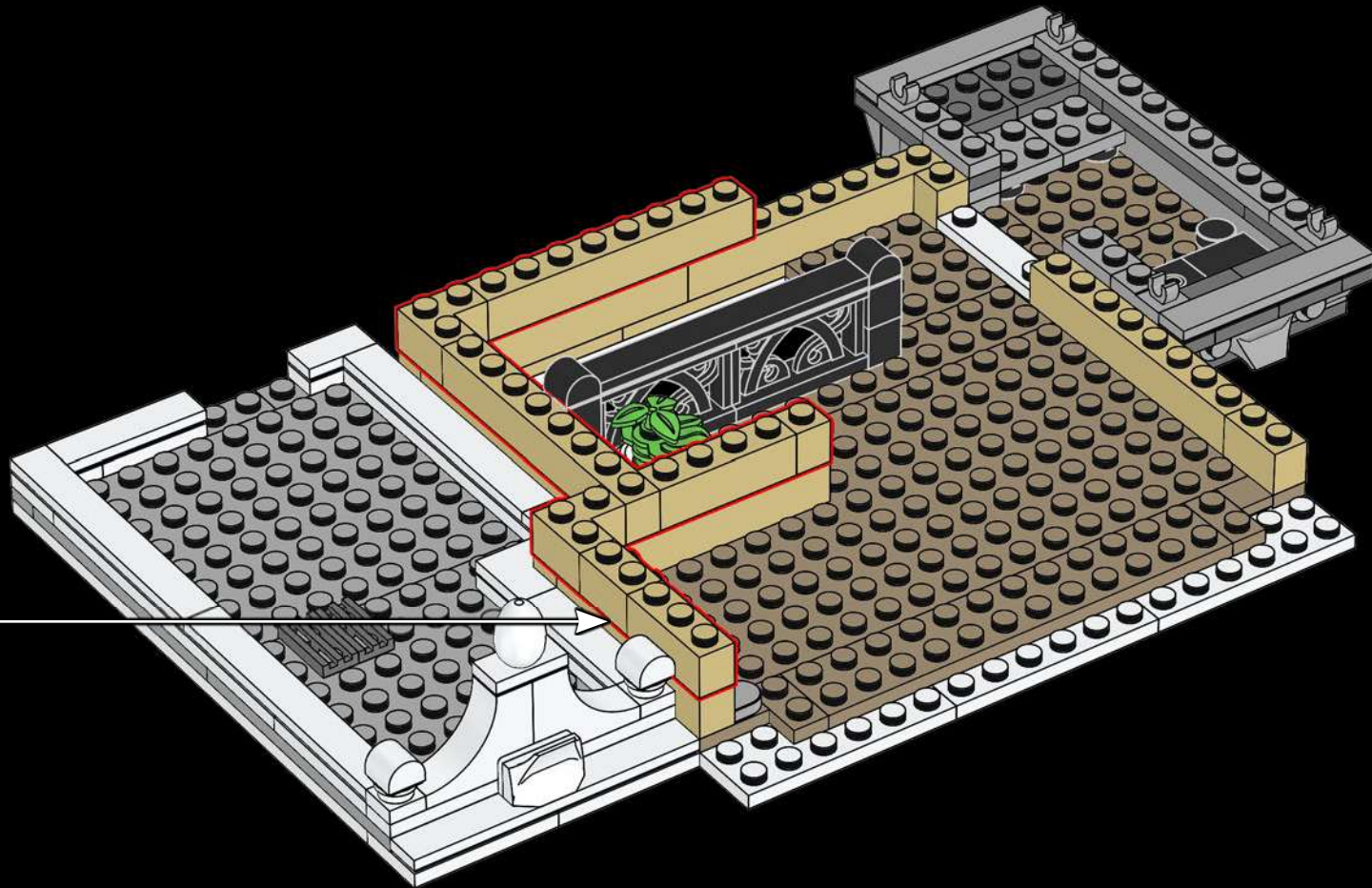

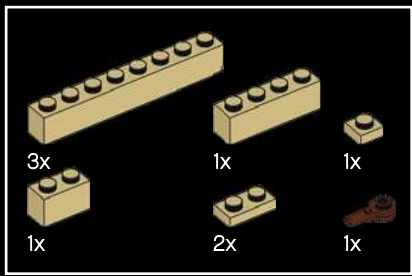

315

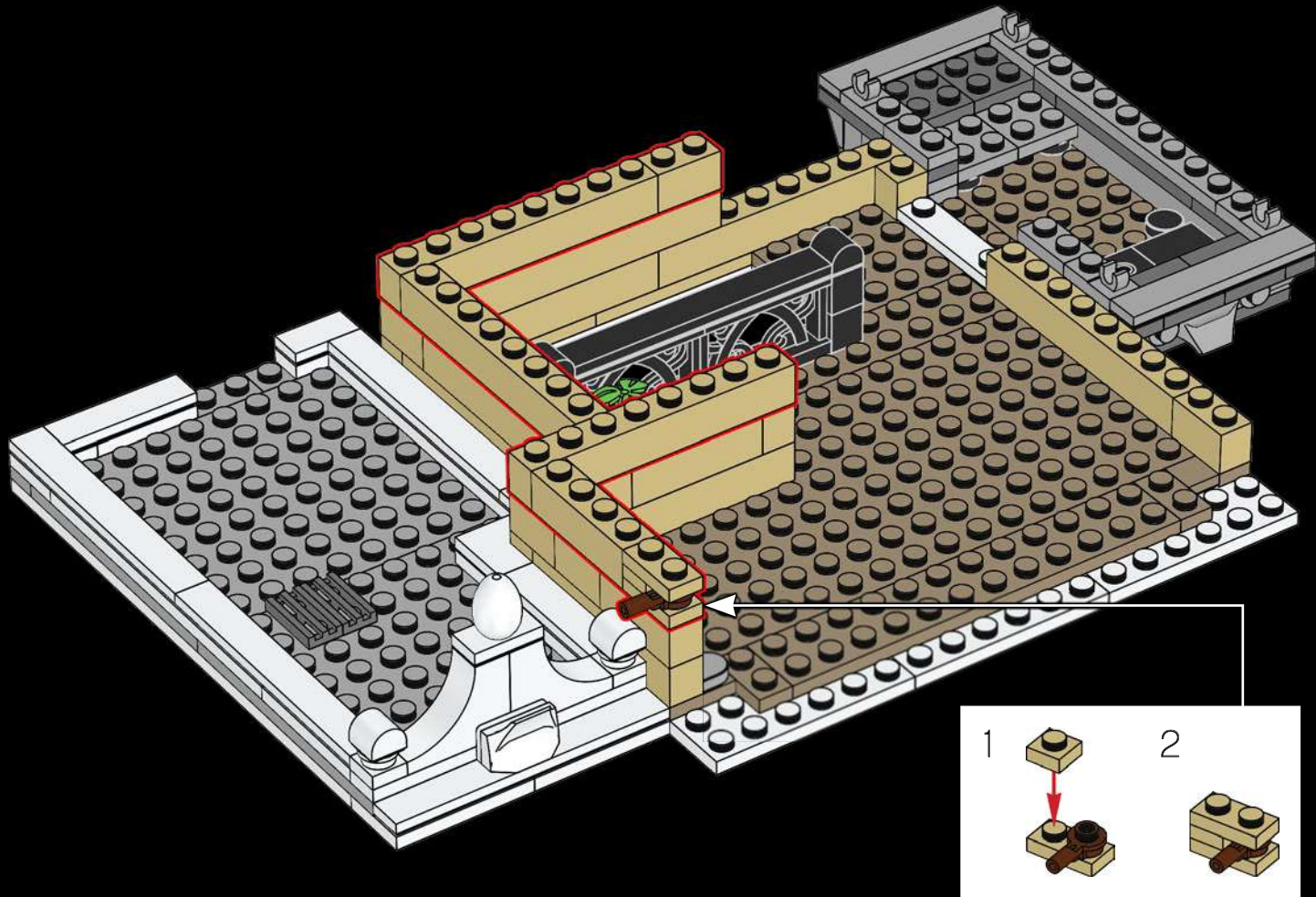

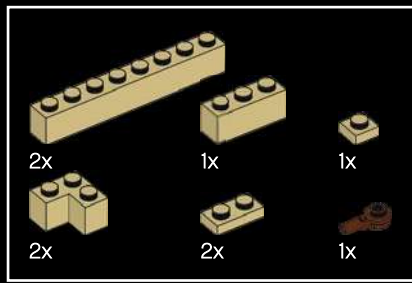

316

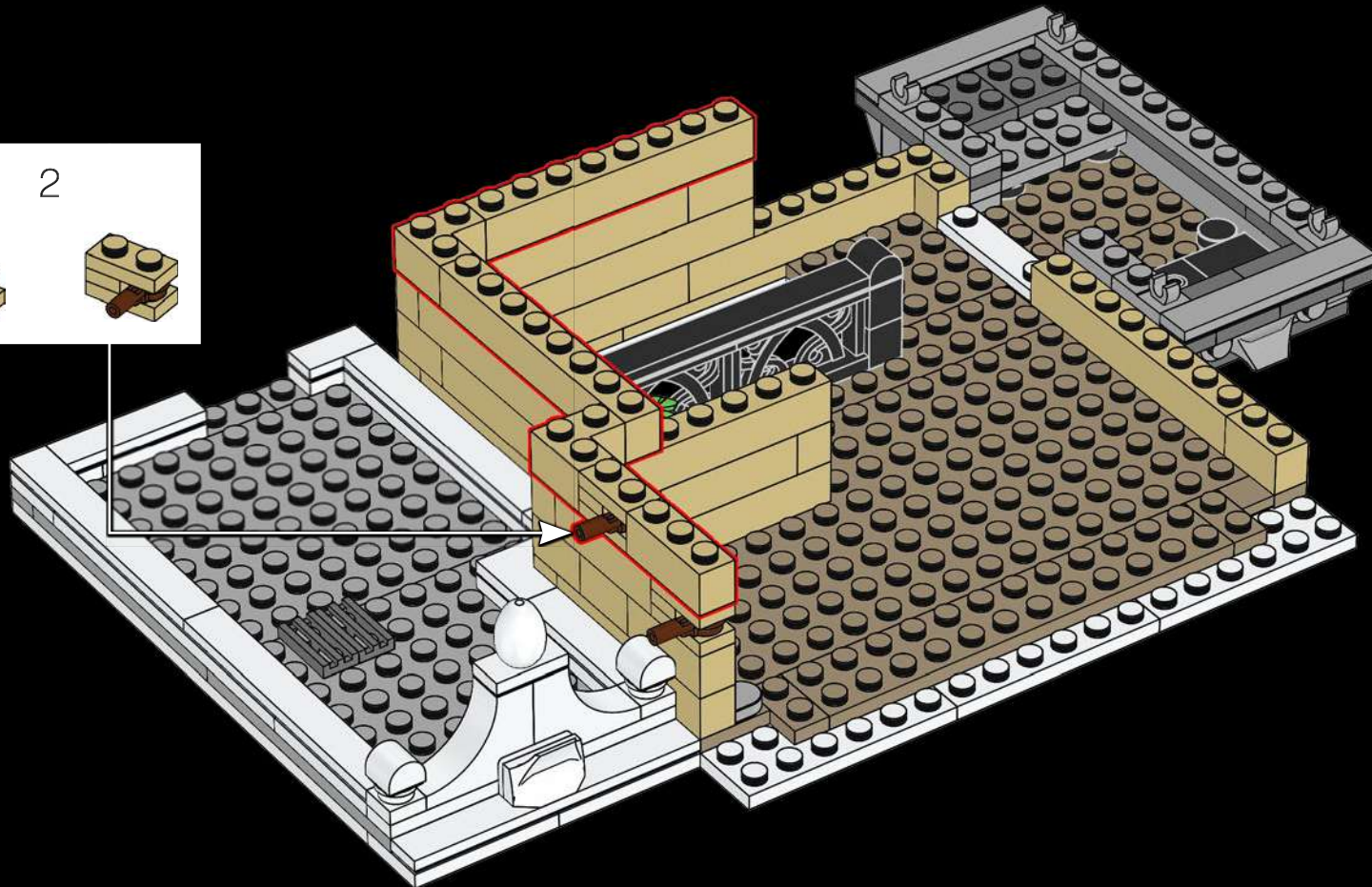
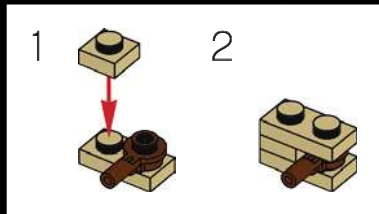

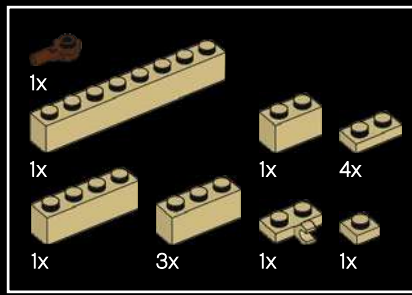

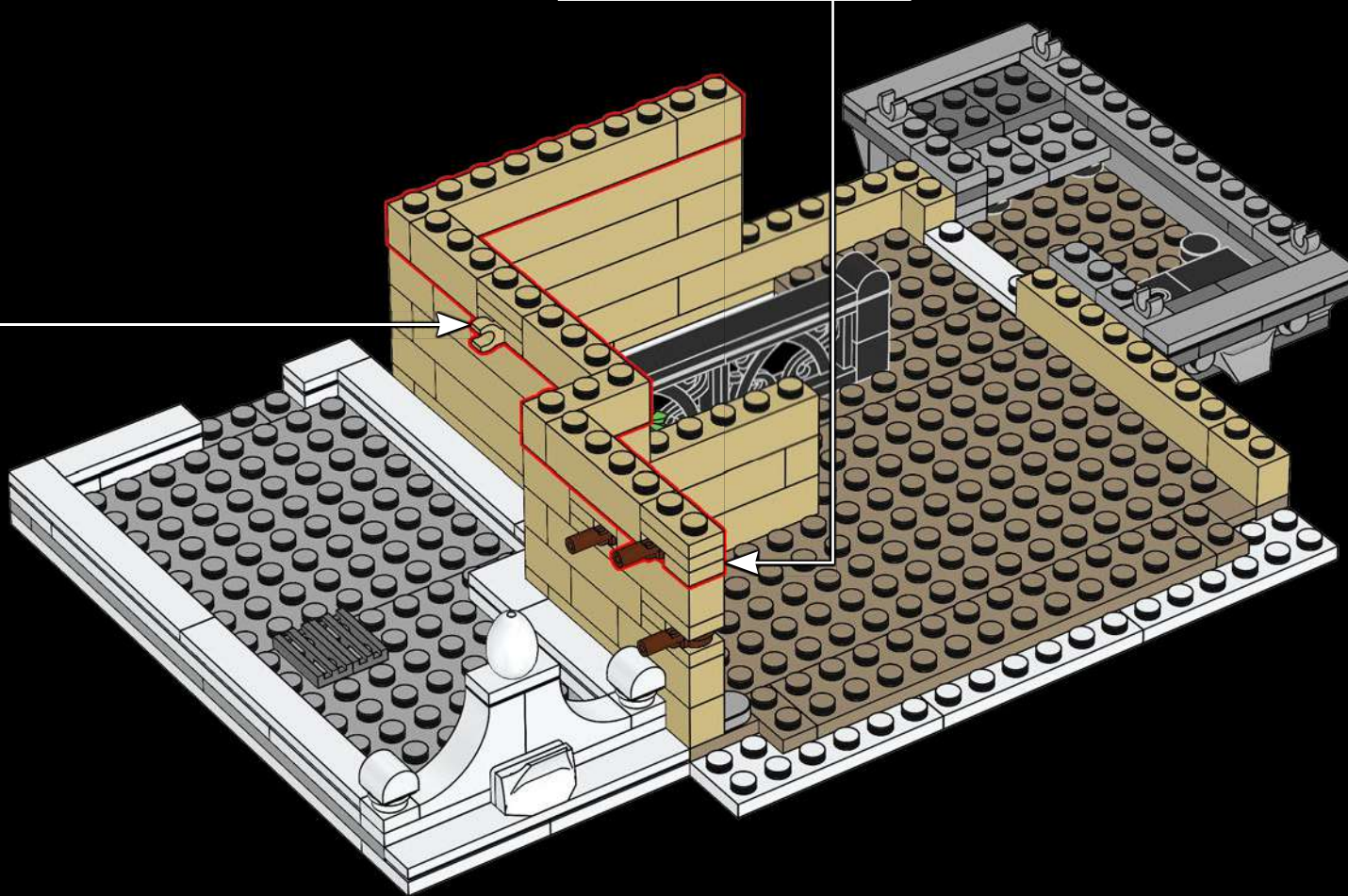
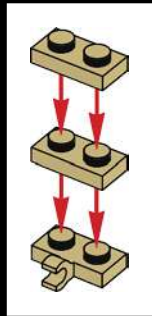
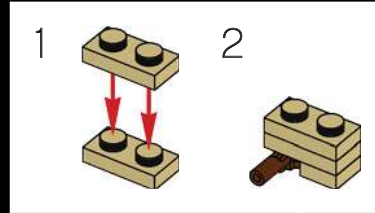

317

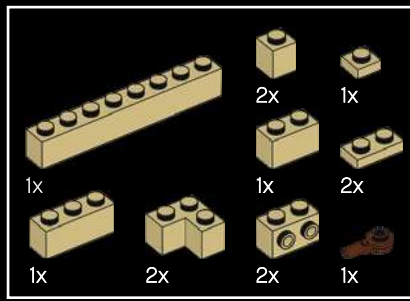

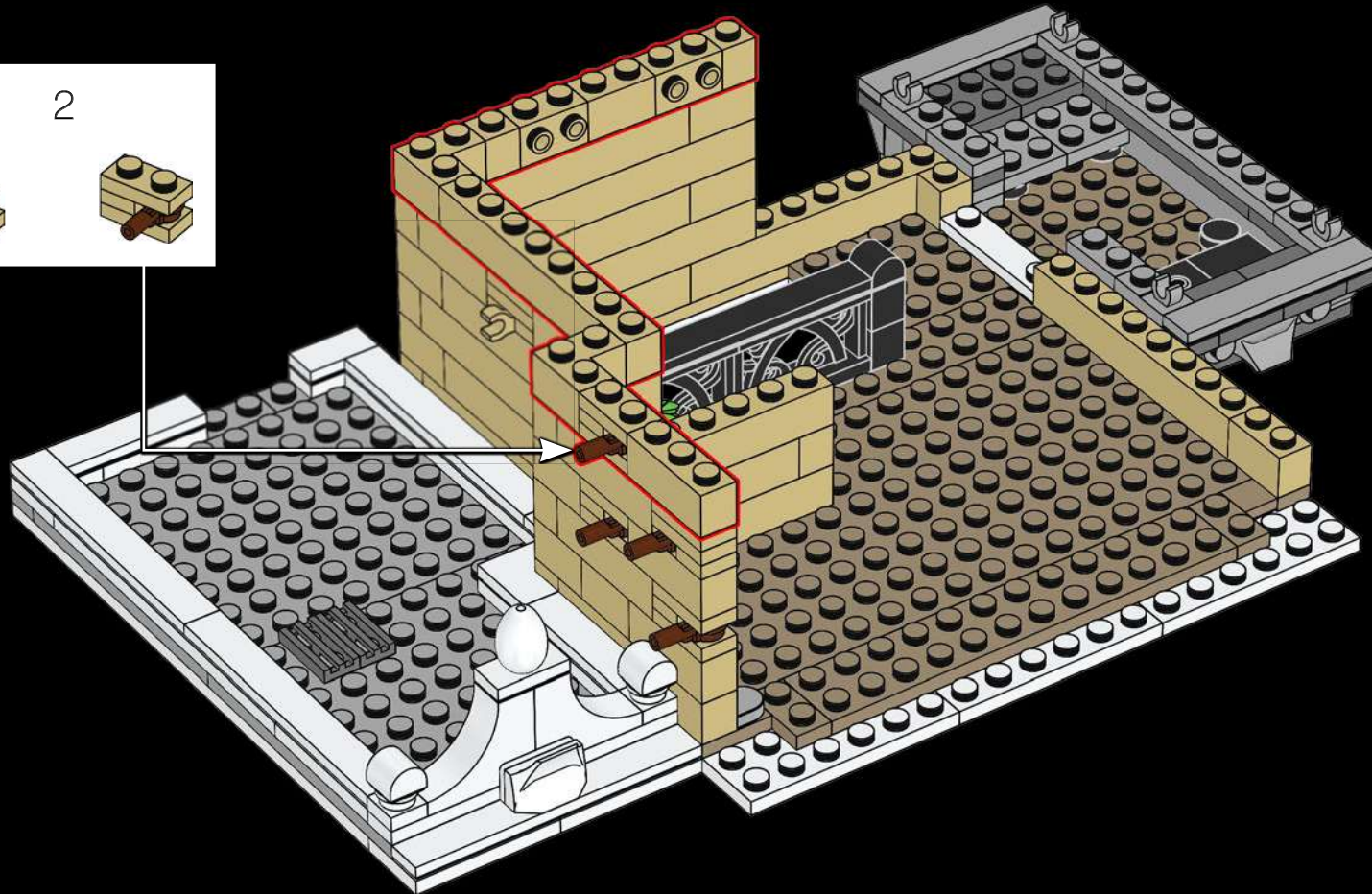
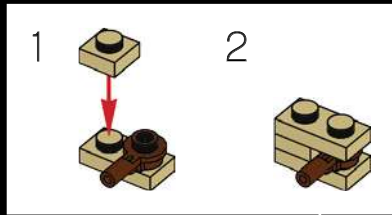

318



1x  3x 

319

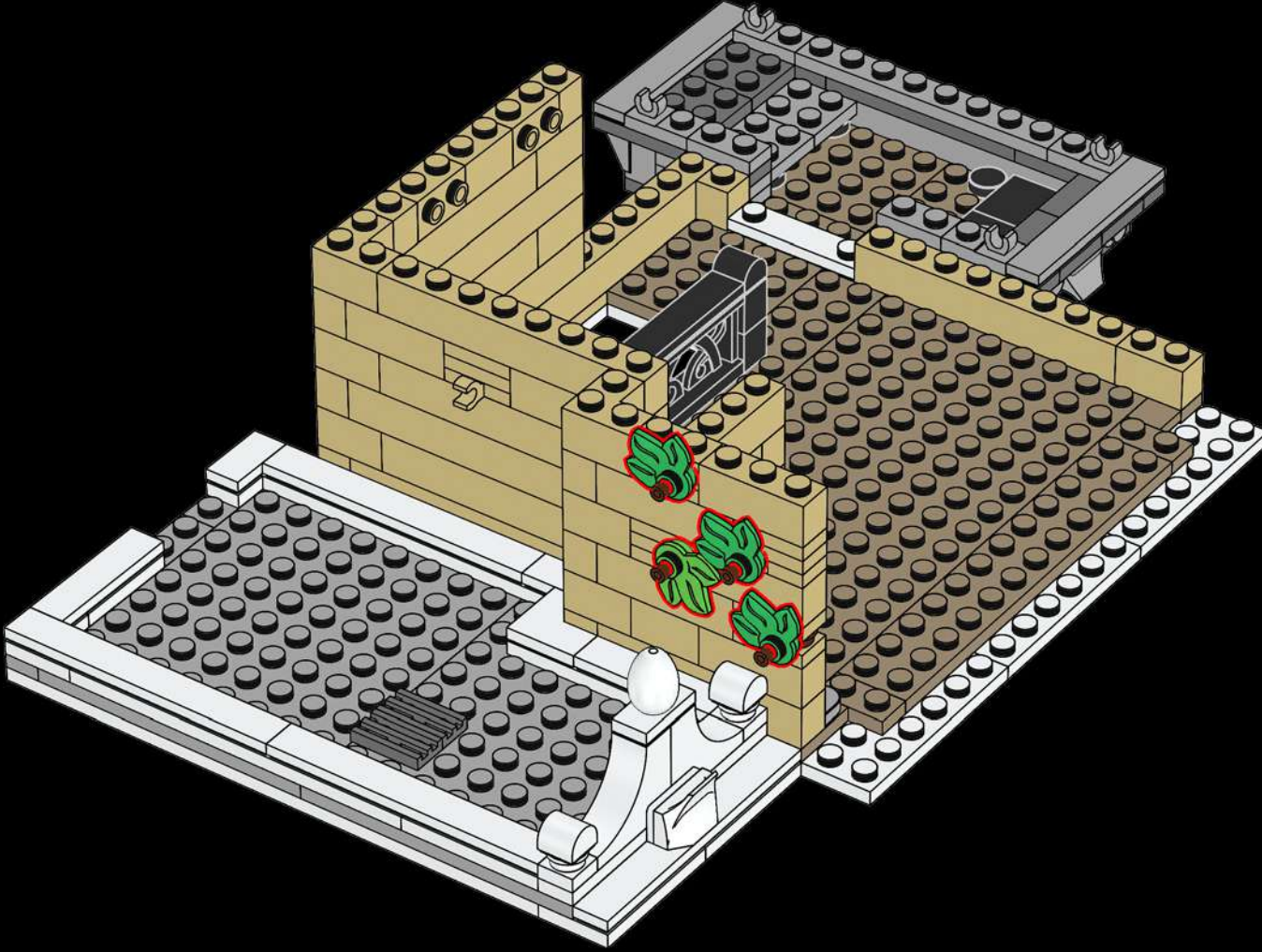





320

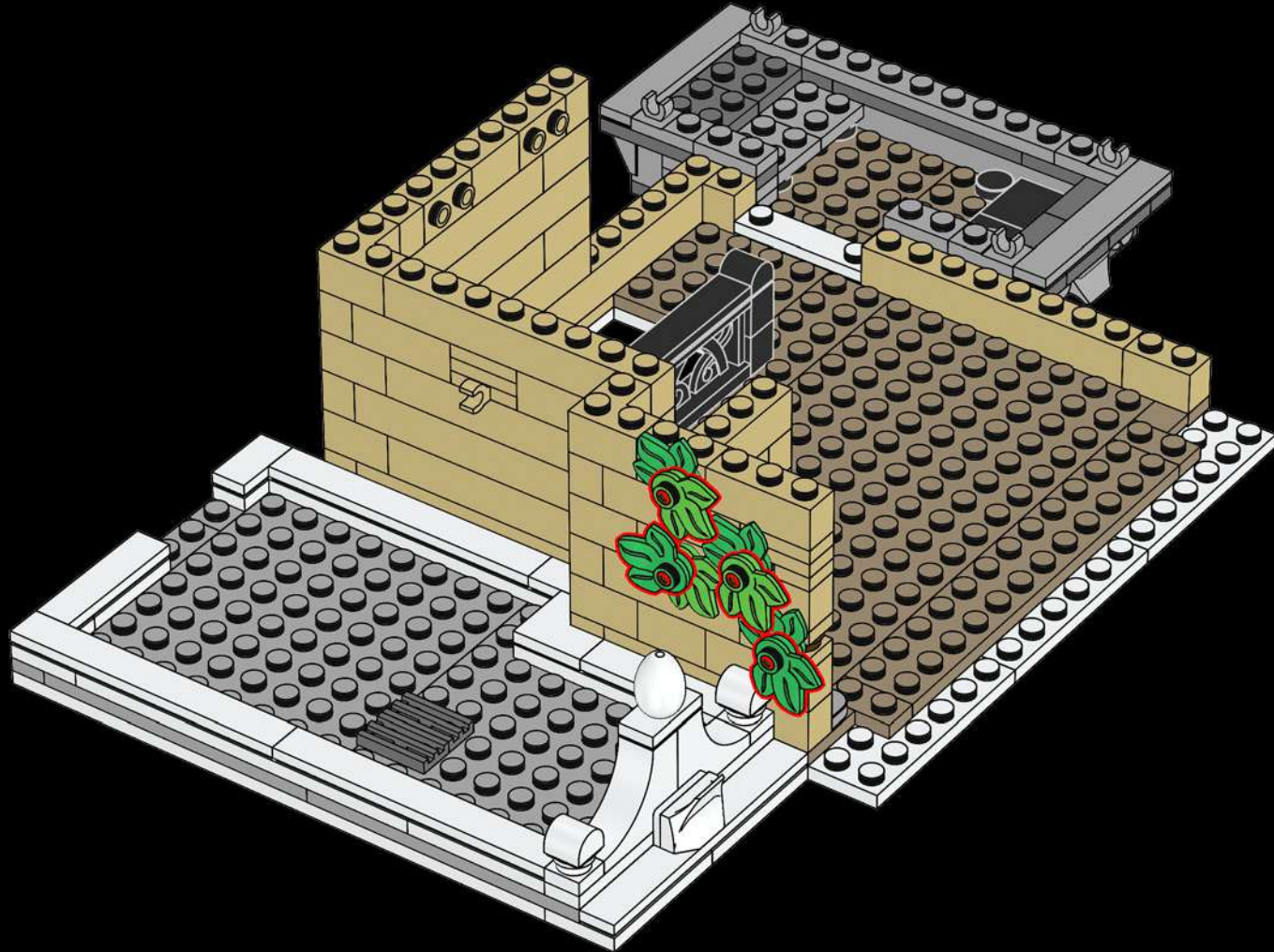

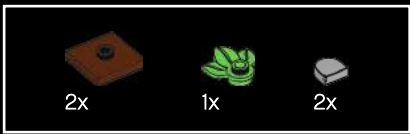

321

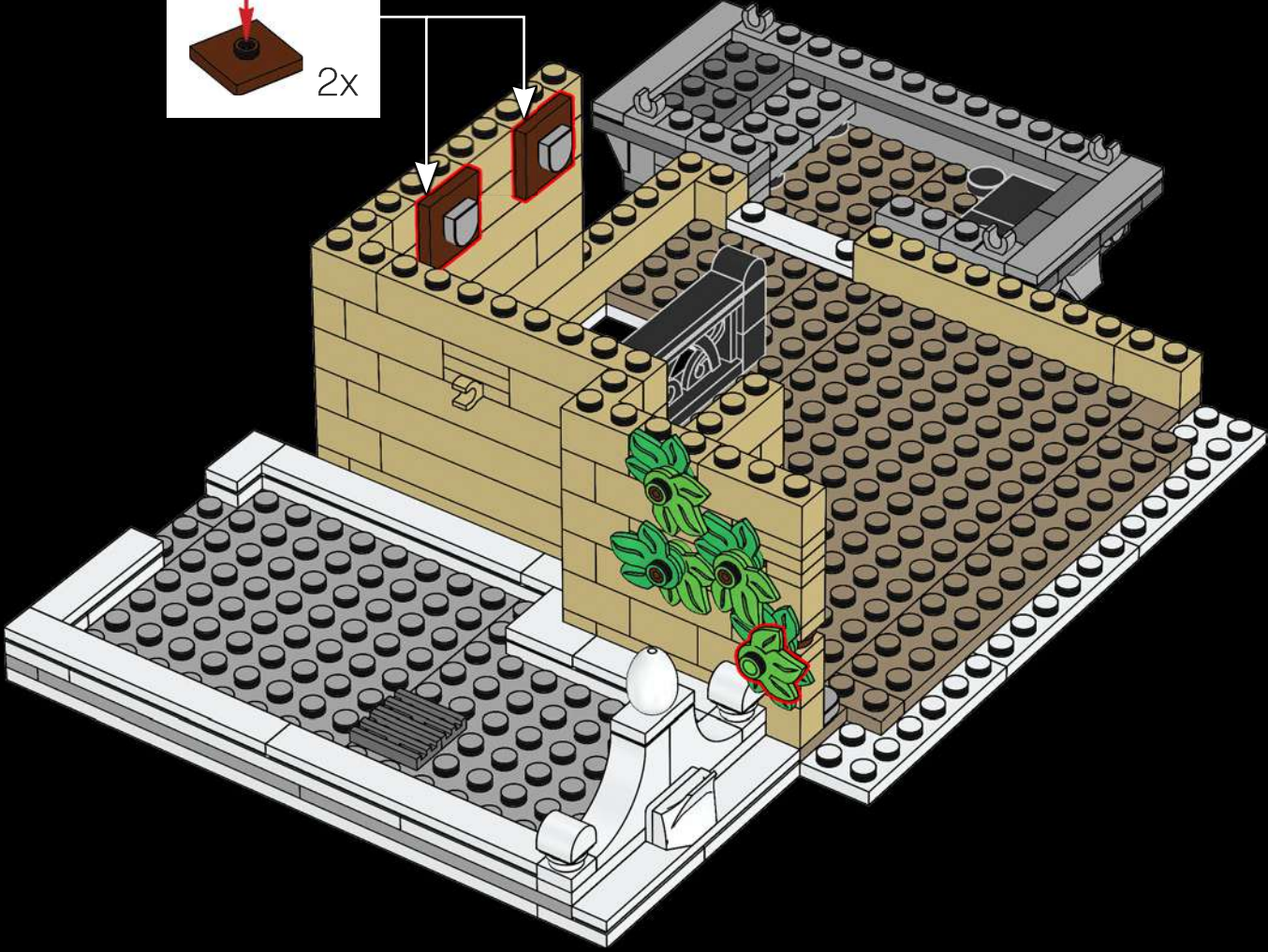
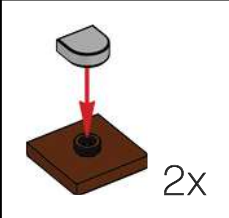



The chief inspector knows every brick of the police station and wants to take a bite out of crime.

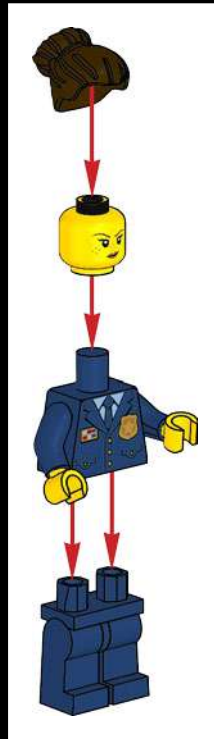

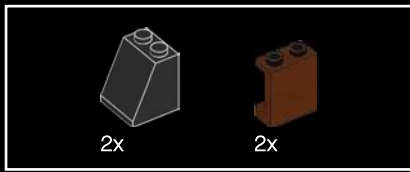

323





324

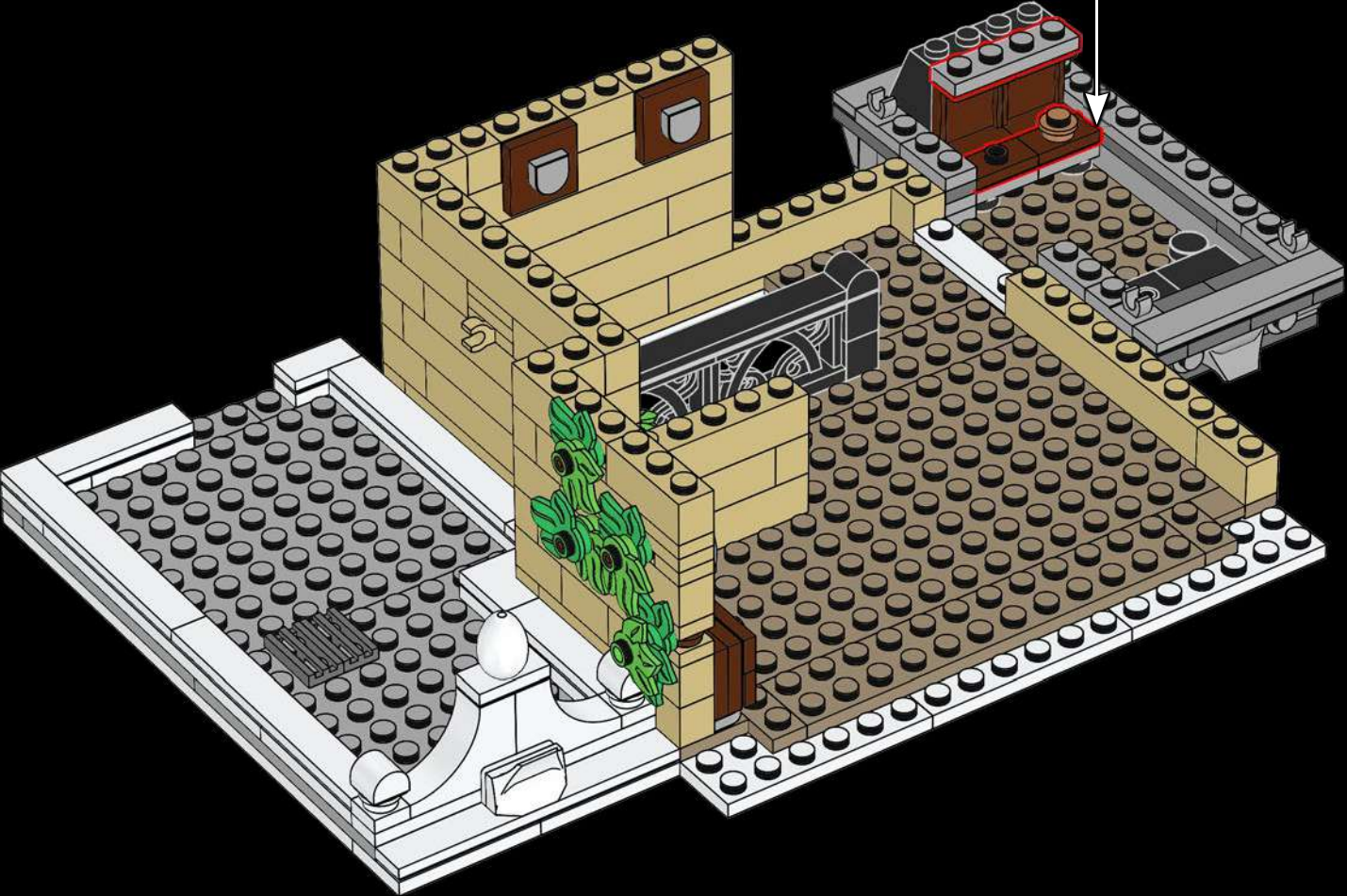

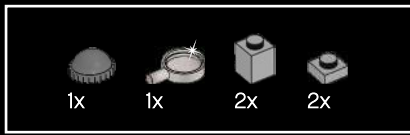

325

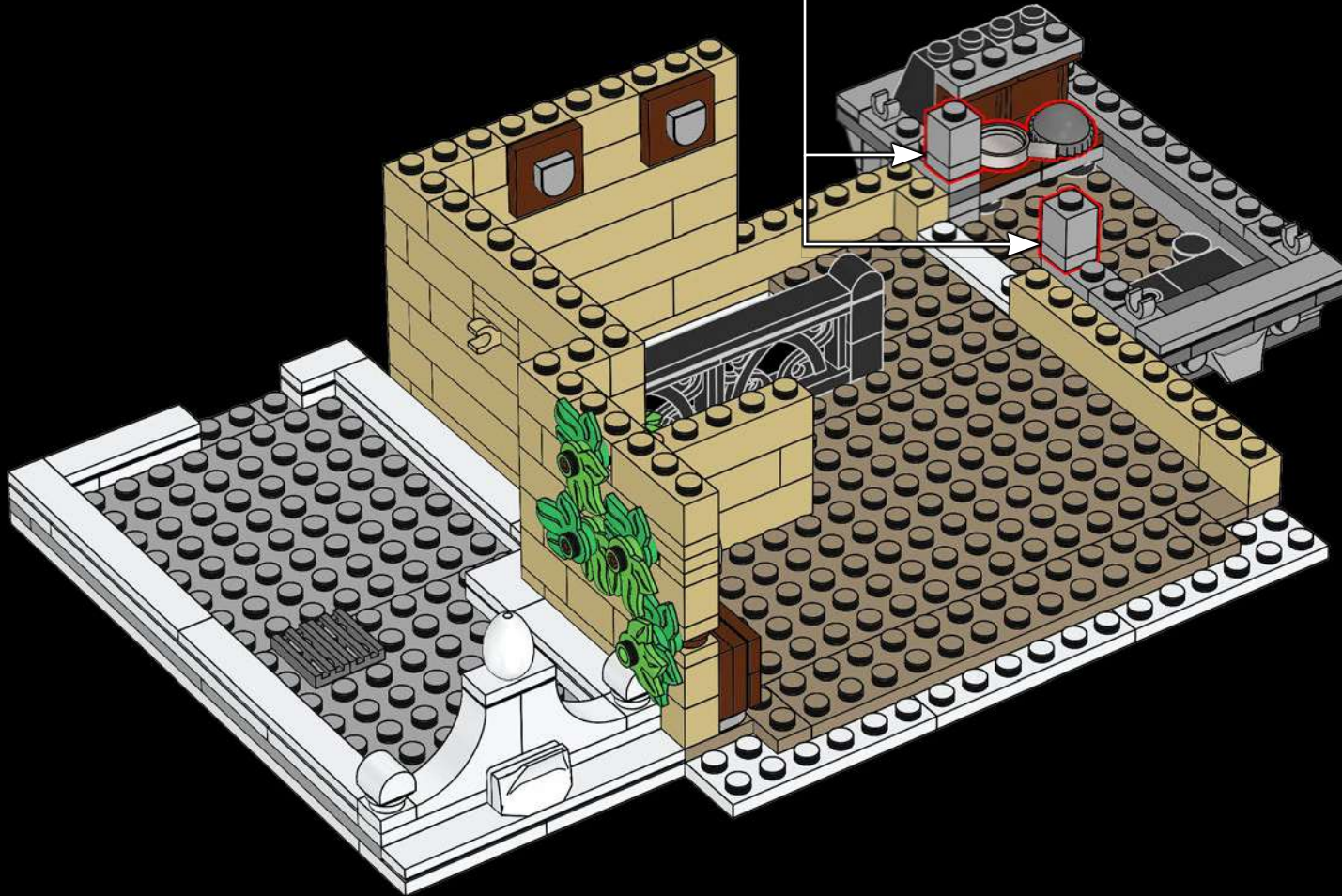
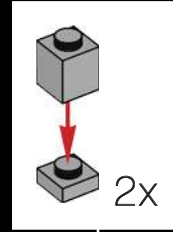

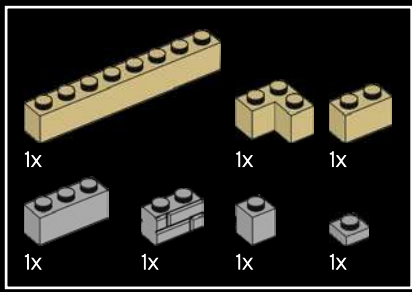

326





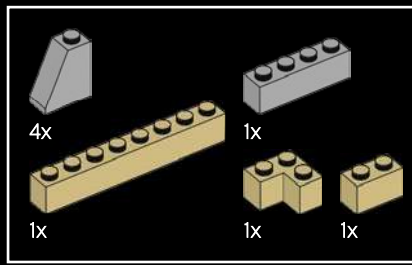

327

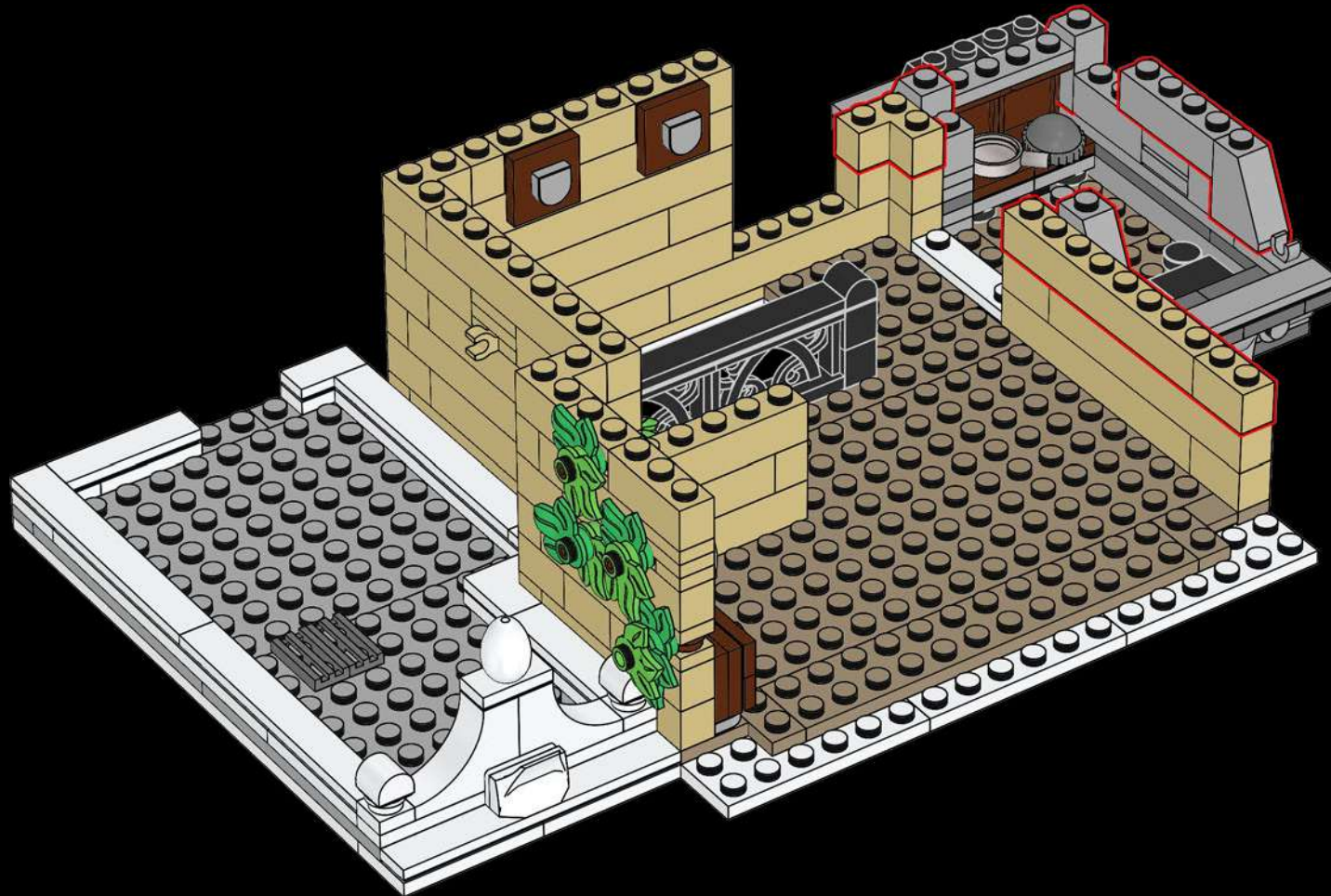

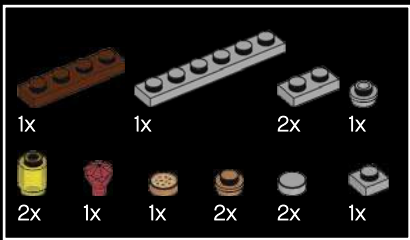

328

1

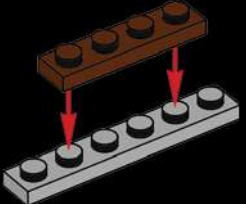

2

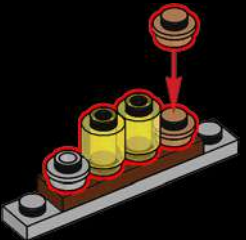

3



4



5

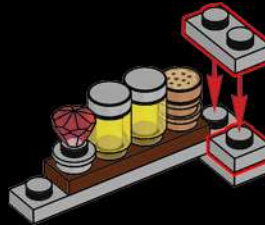



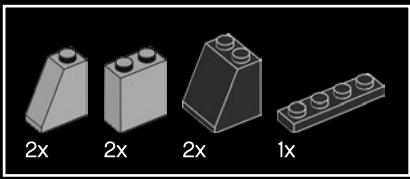

329

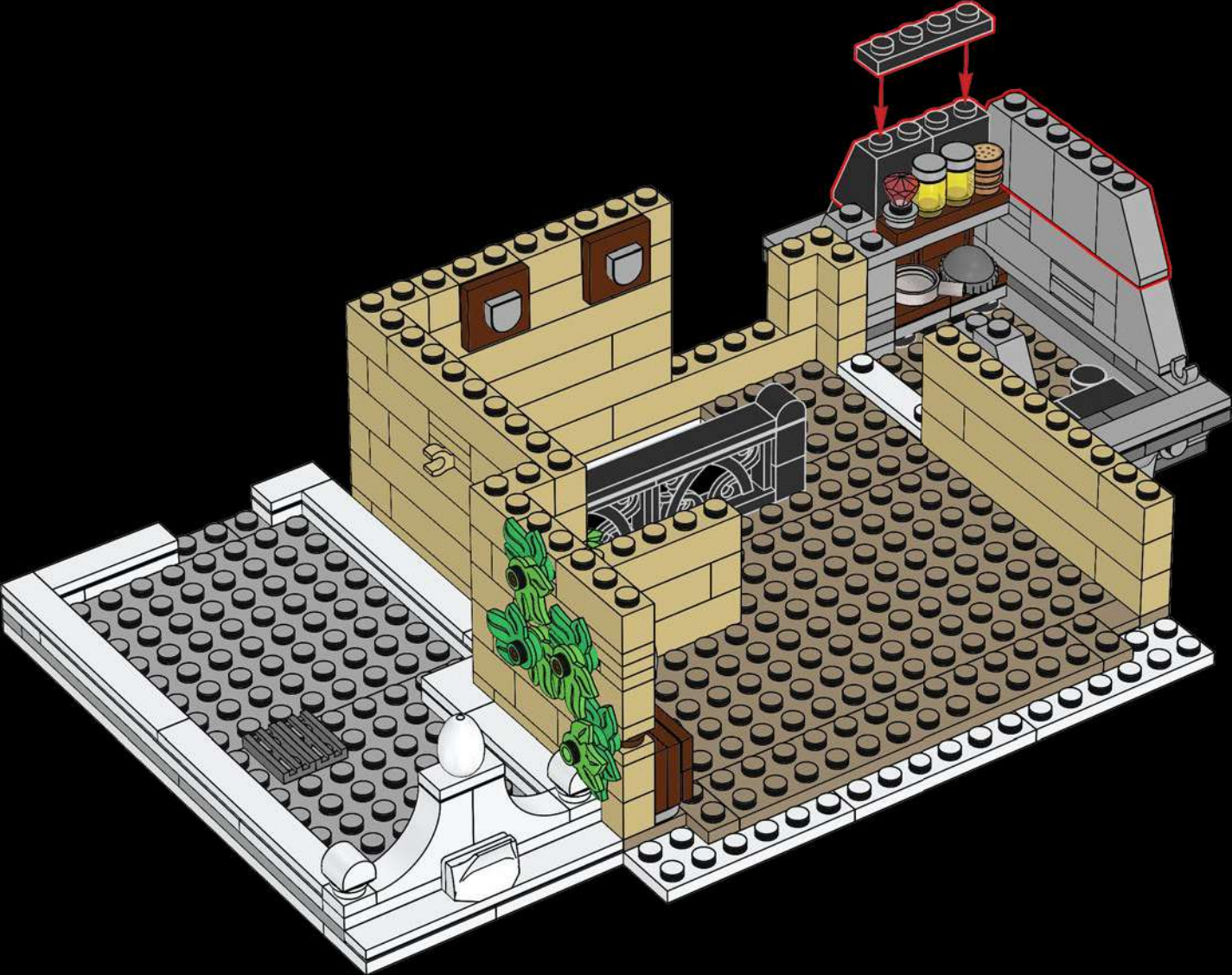

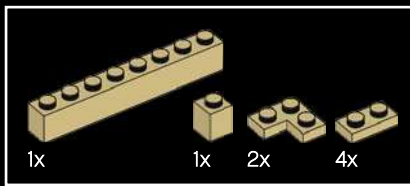

330

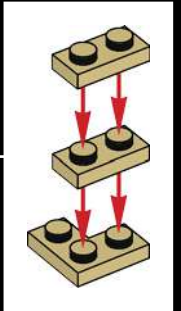
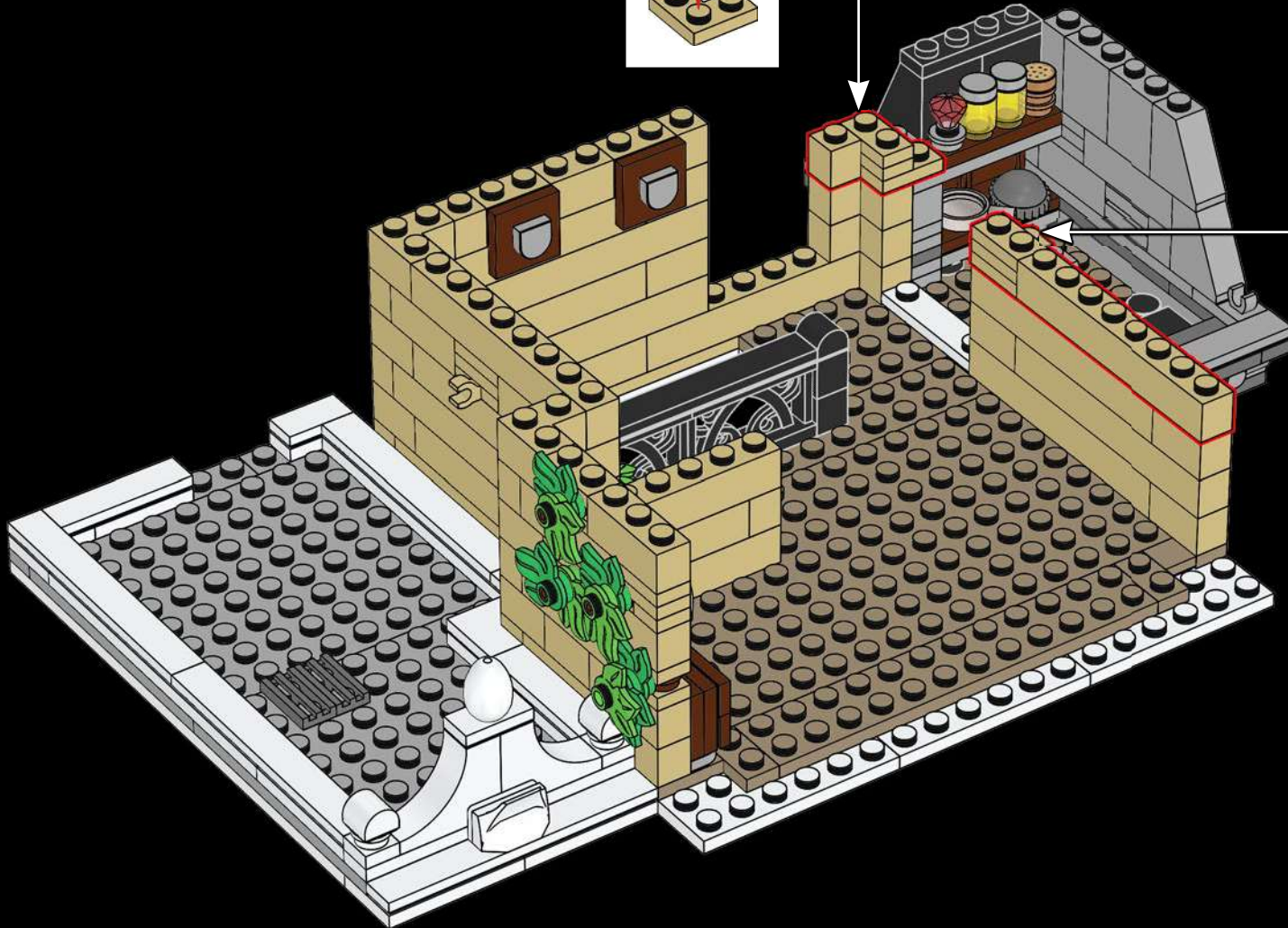
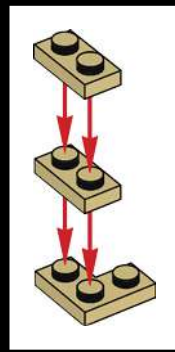

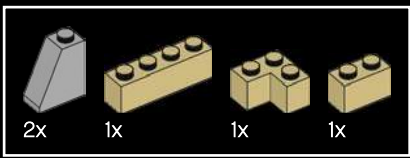

331

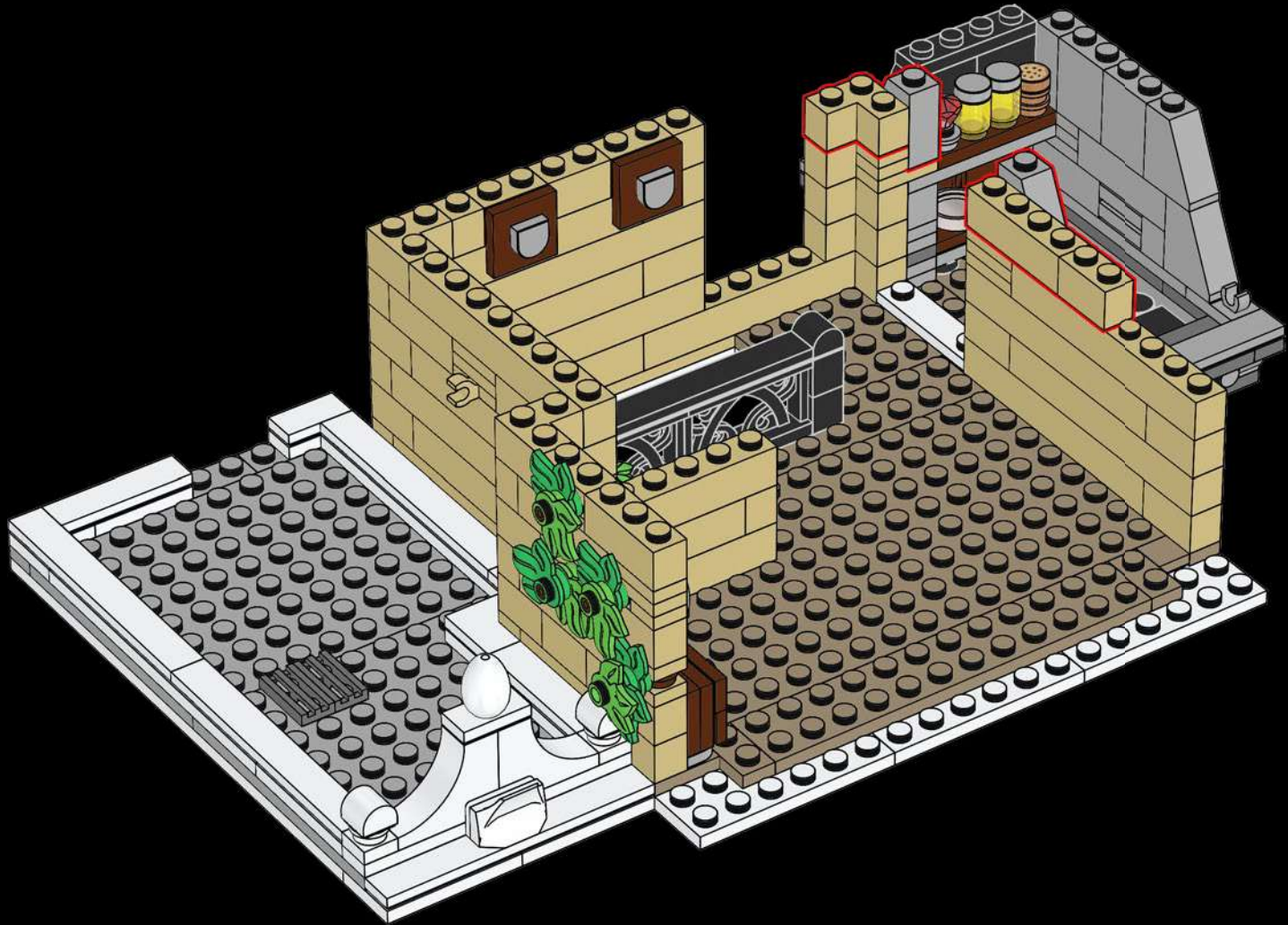

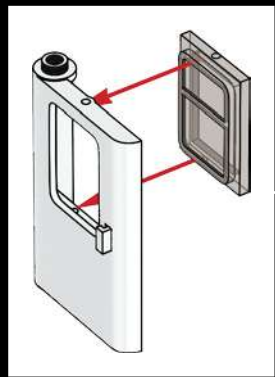
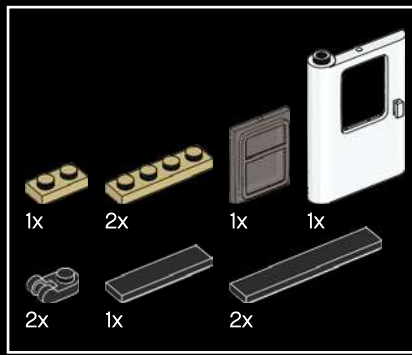

332

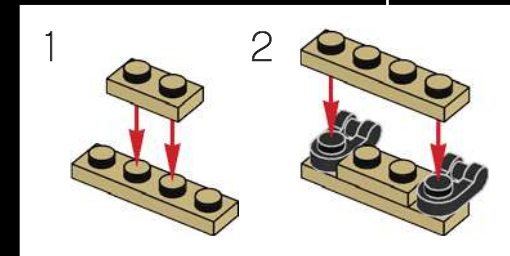
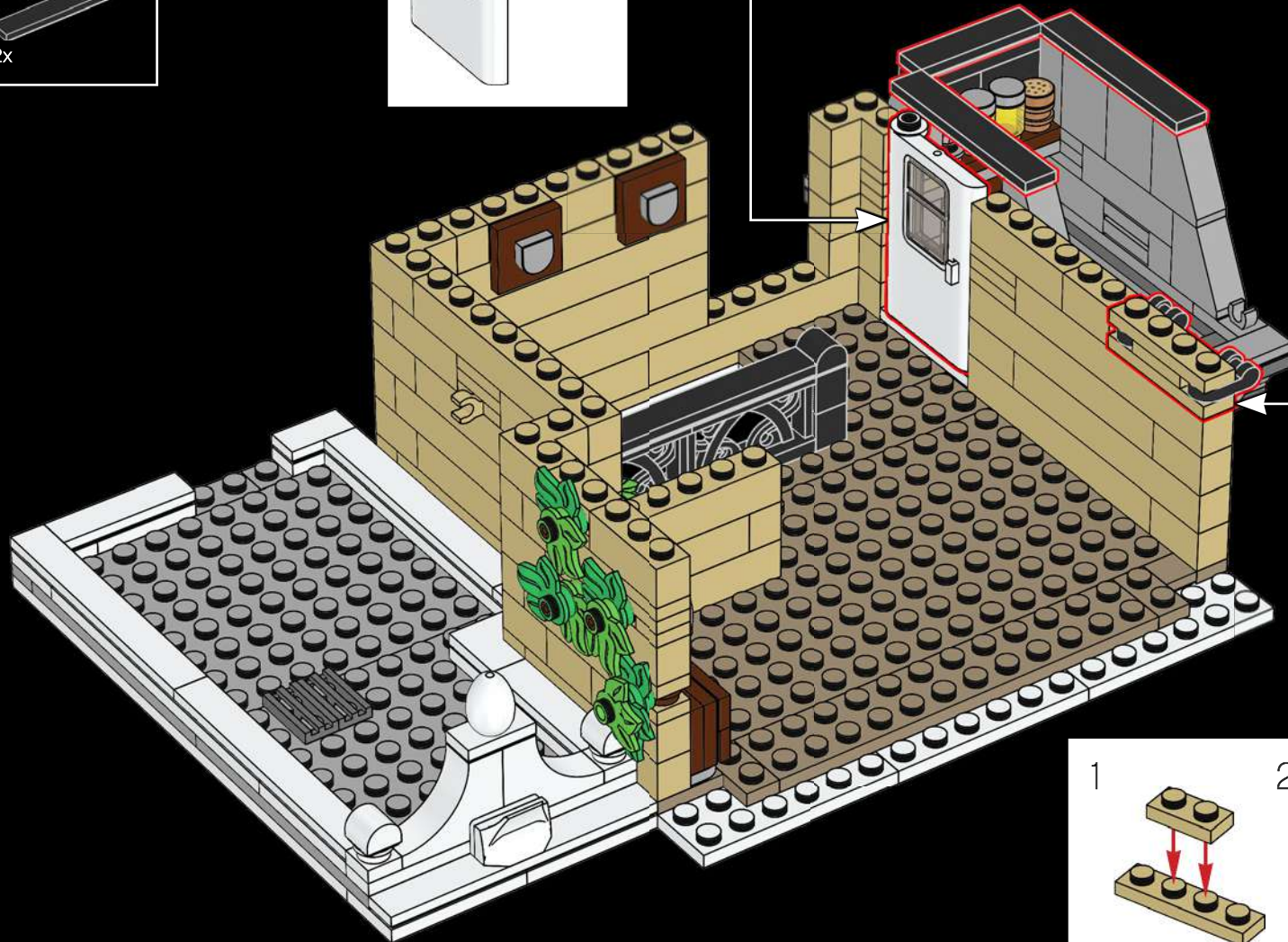

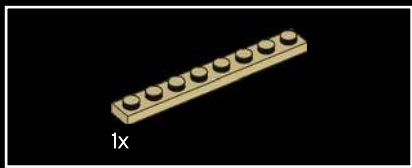

333

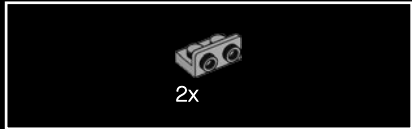
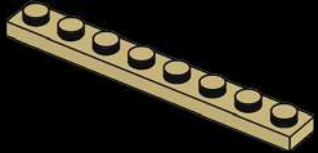

334

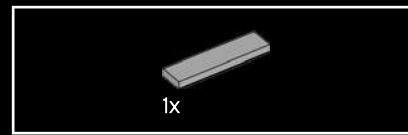
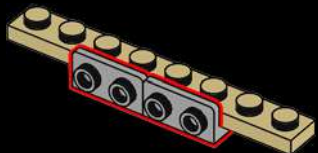

335

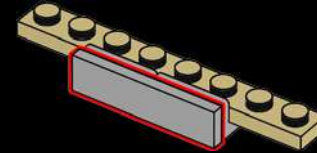

336

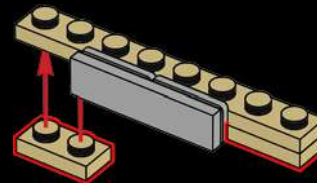

337

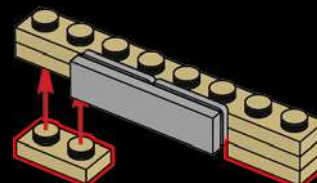



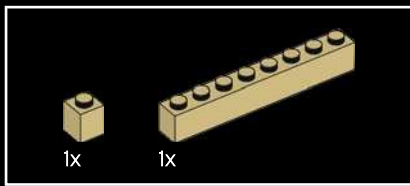

338



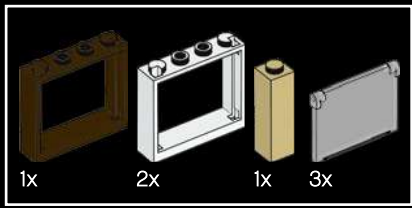

339

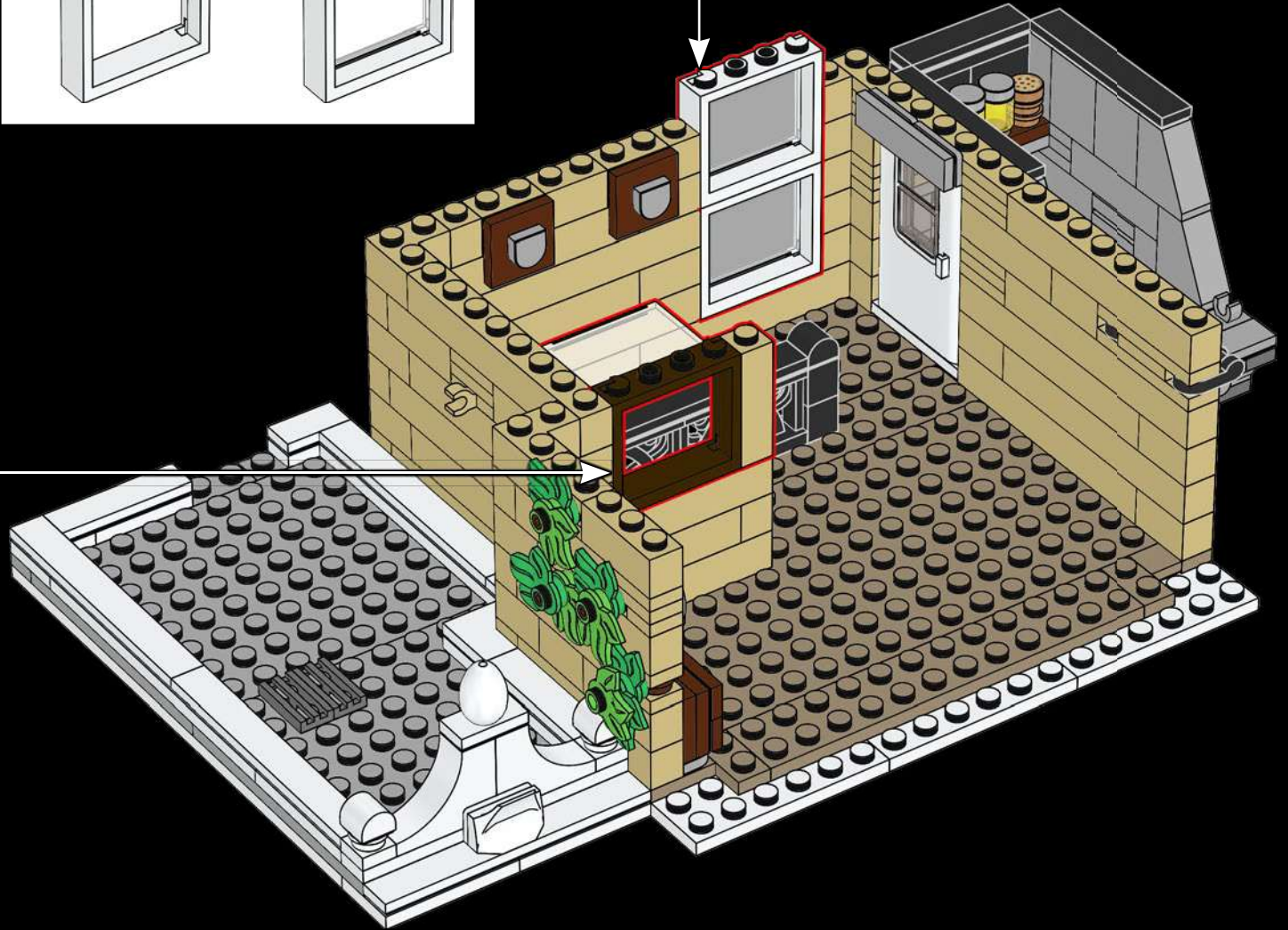
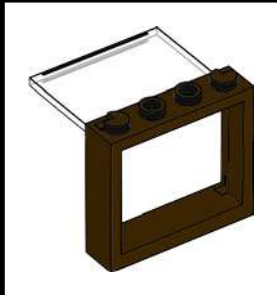
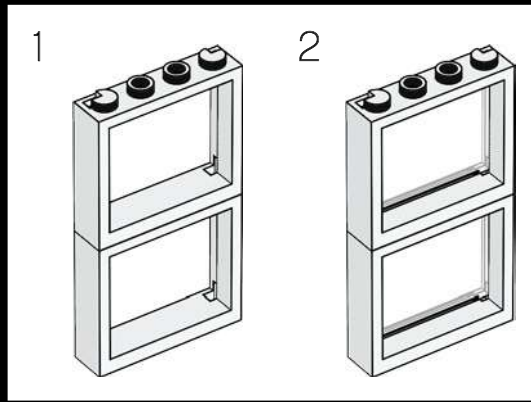



340



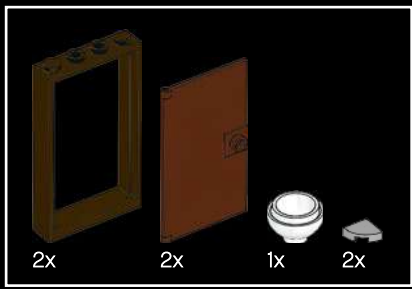

341

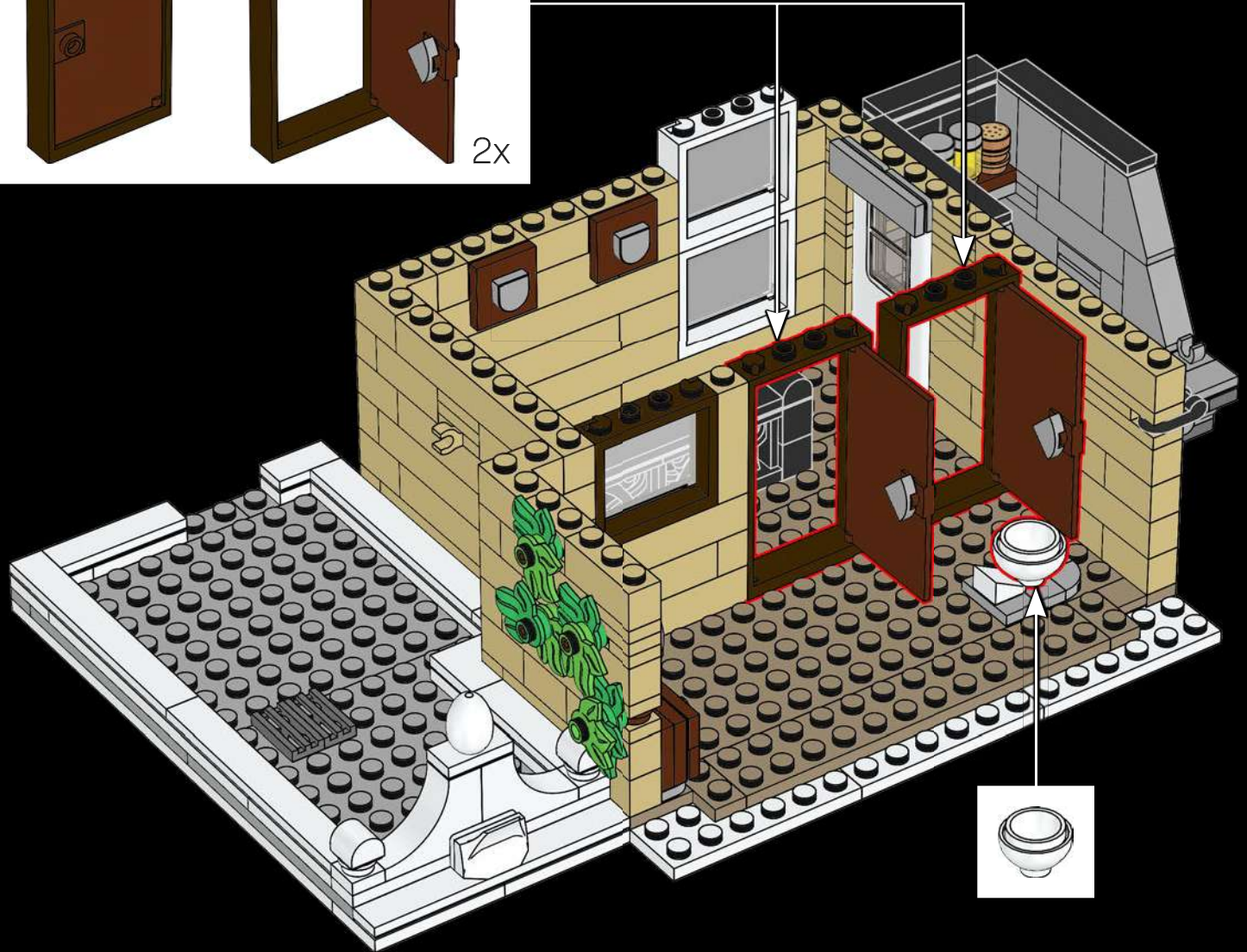
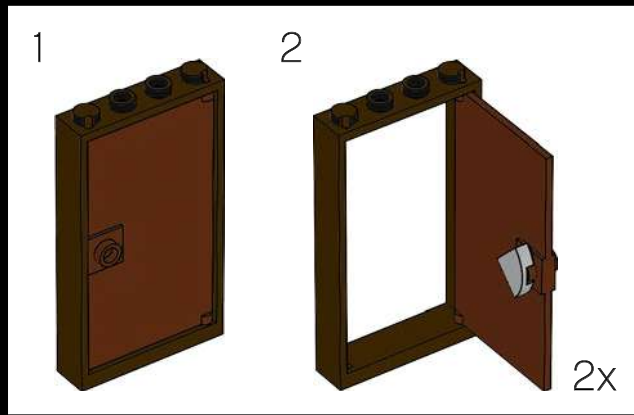

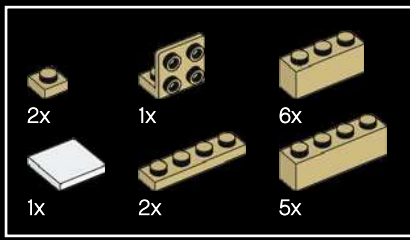

342

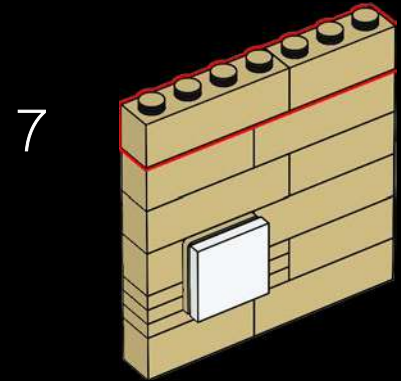
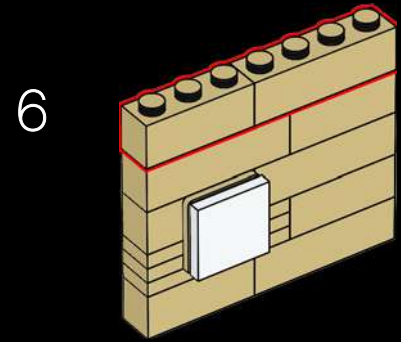
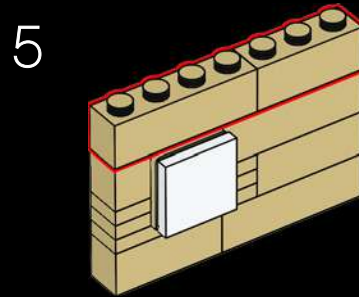
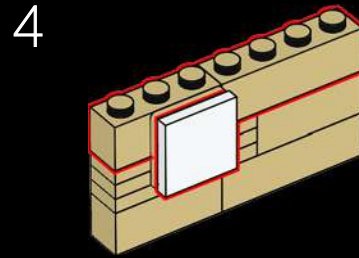
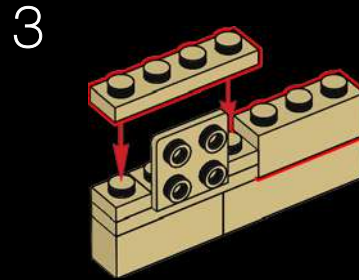
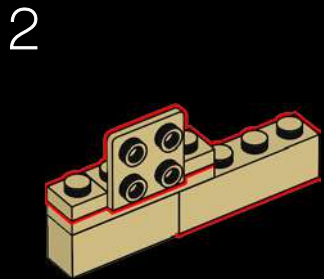
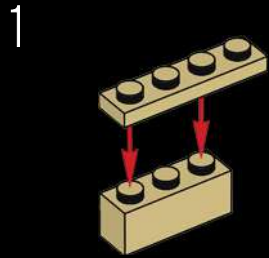

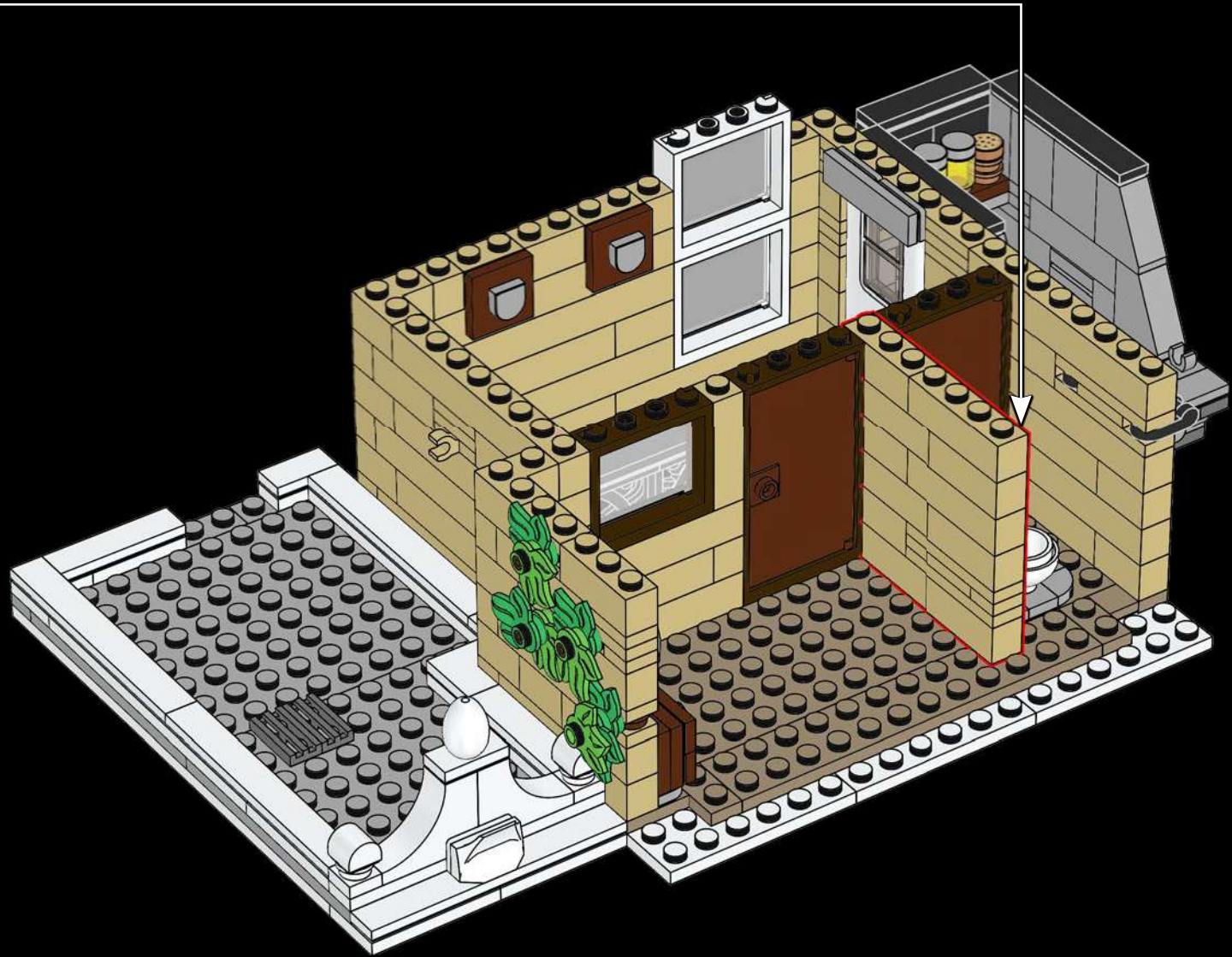

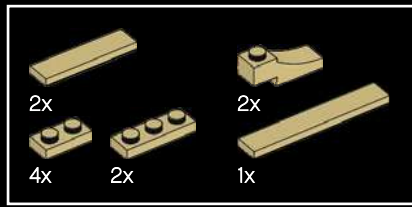

343

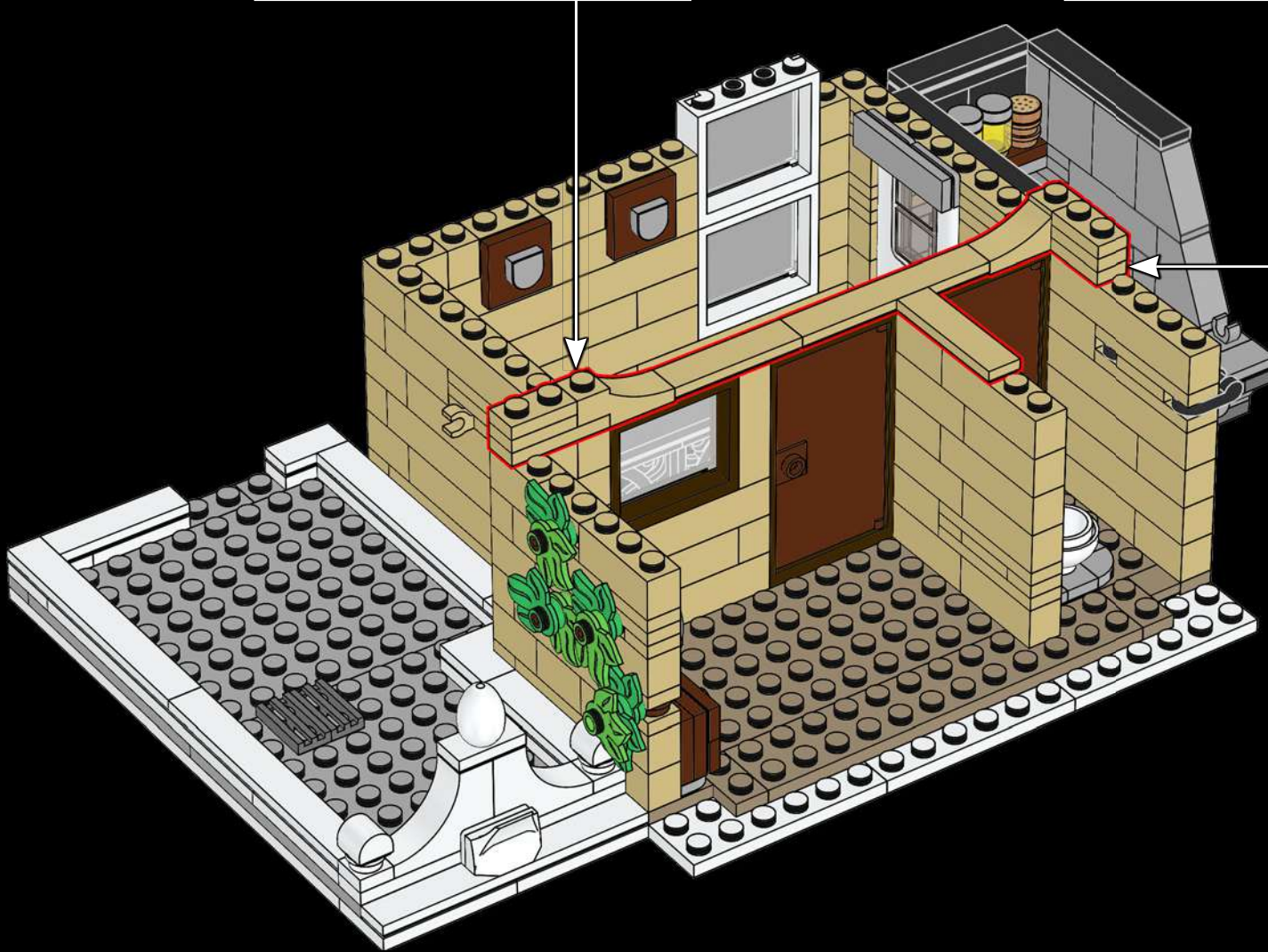
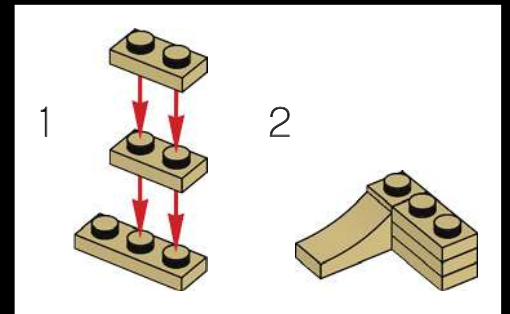
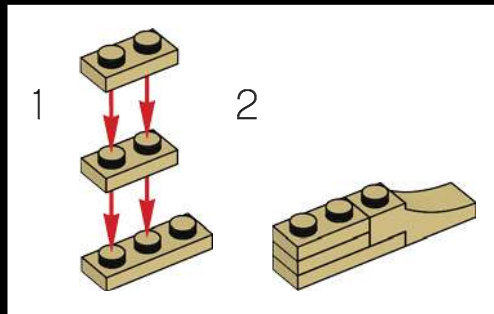

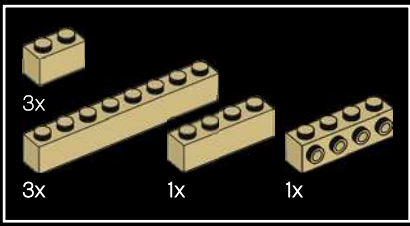

344

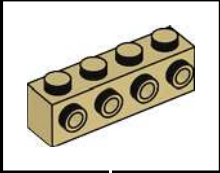



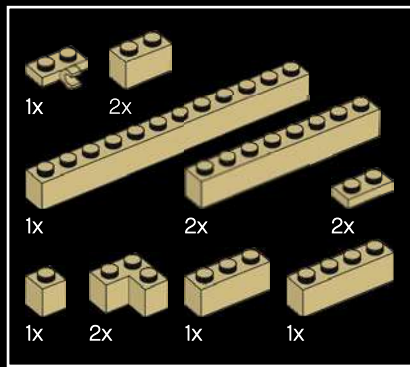

345

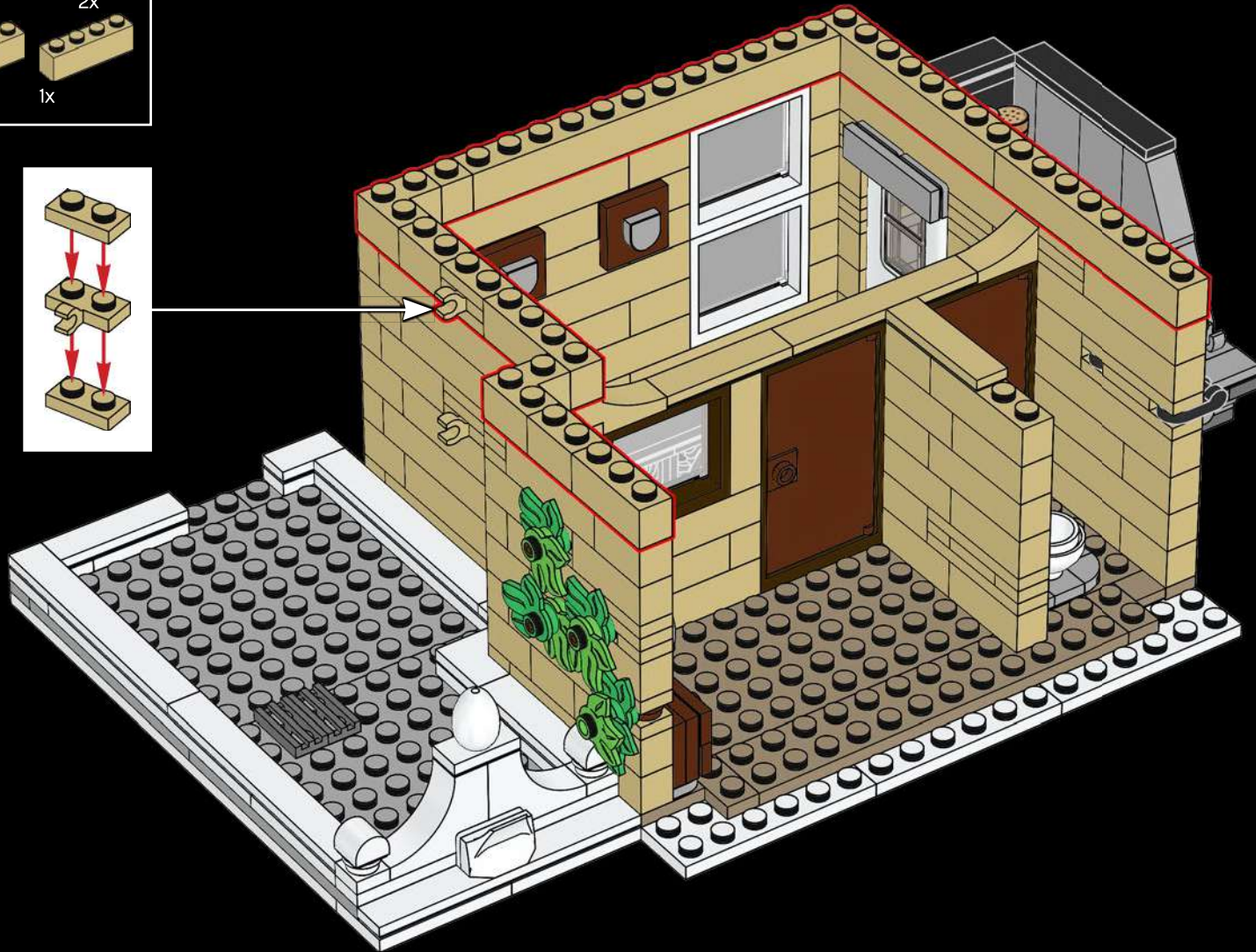
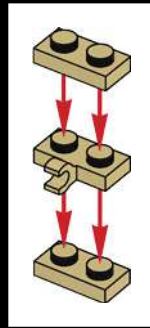

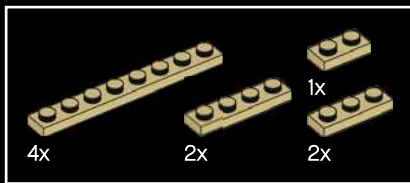

346



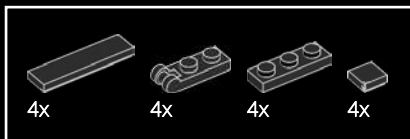

347

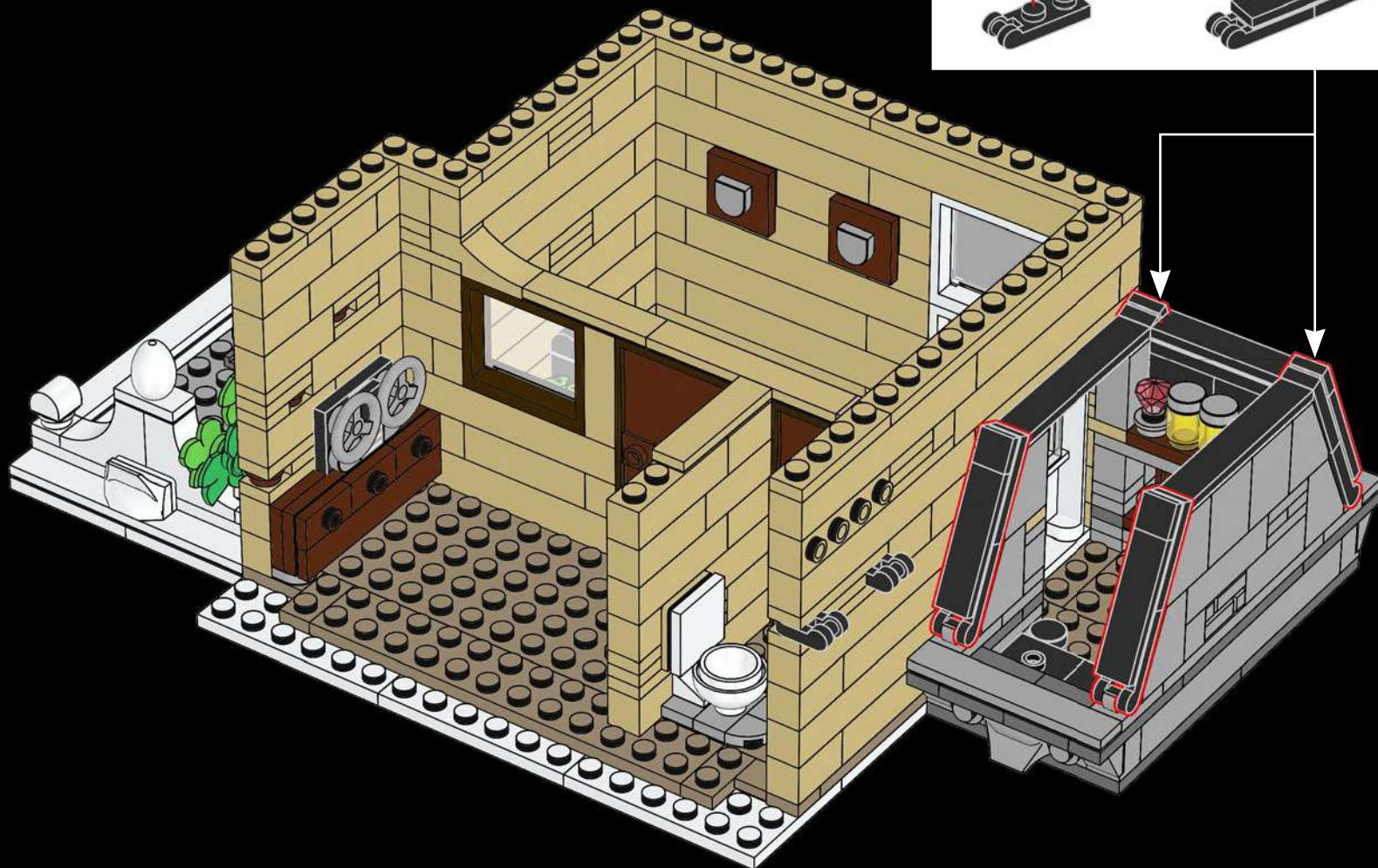
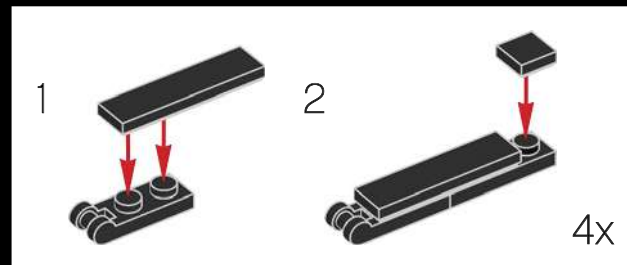

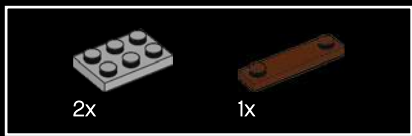

348

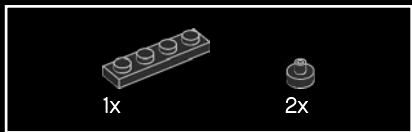
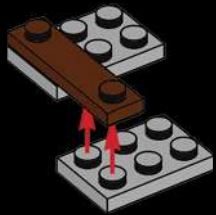

349

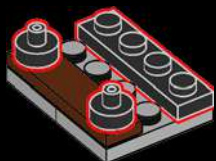

350

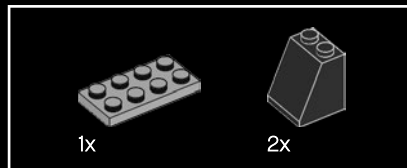

351



352

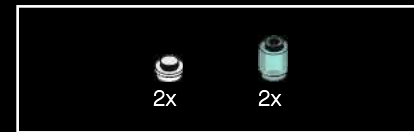

353

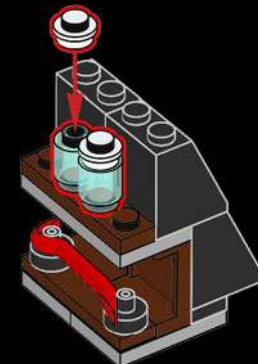

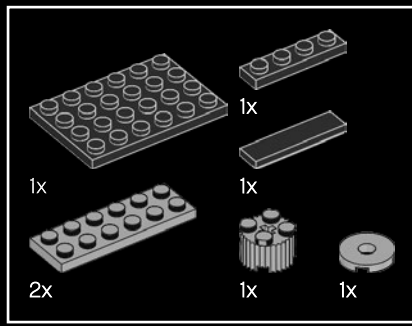

354

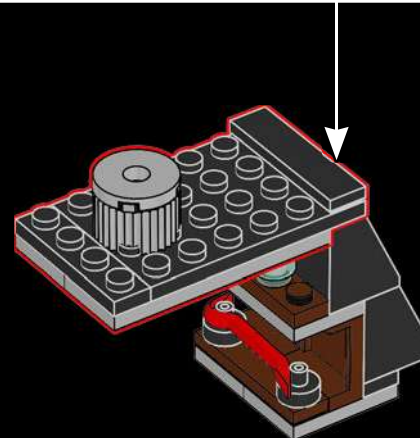
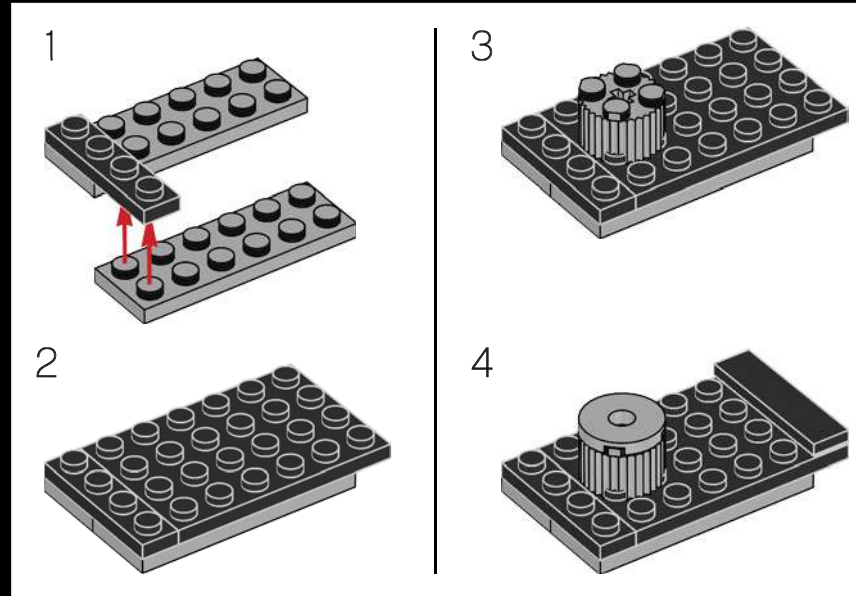

355

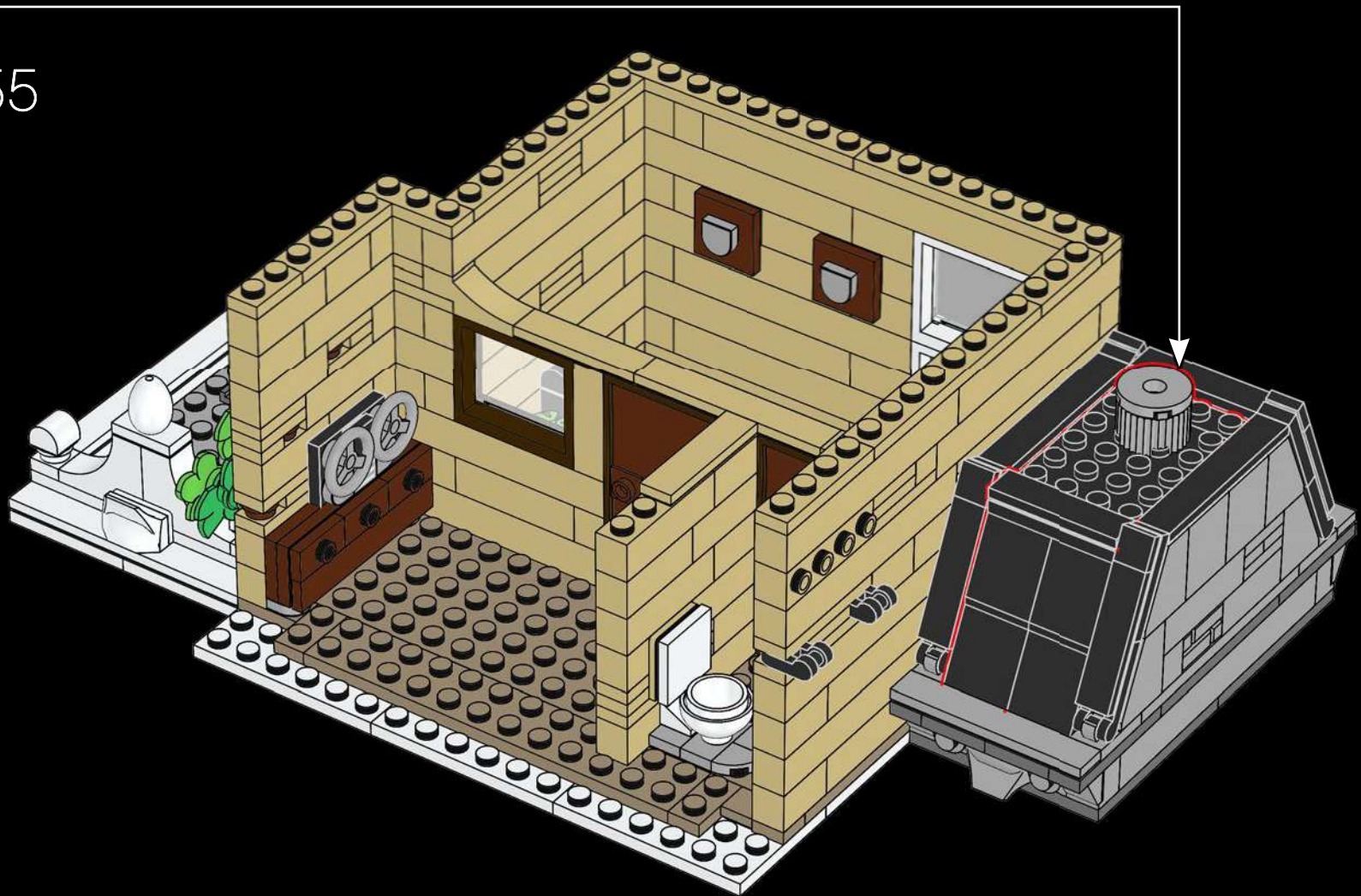



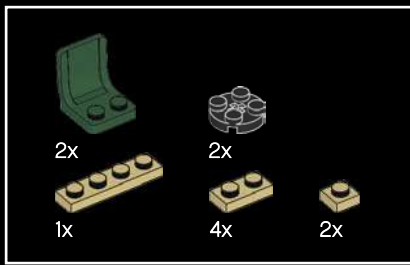

356

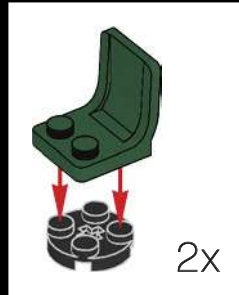





357

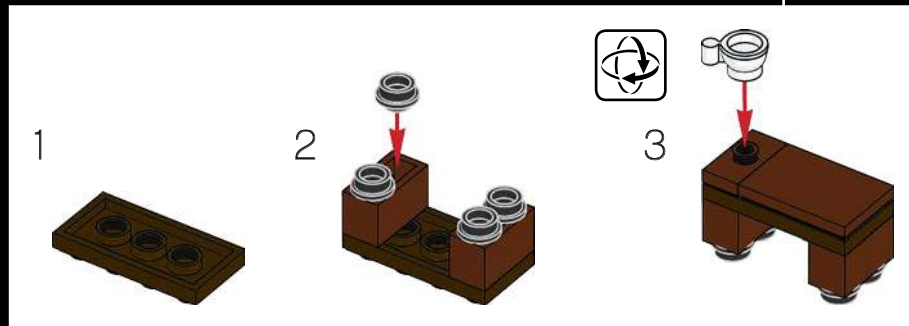

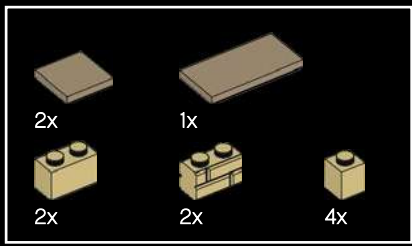

358



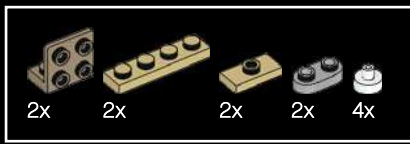

359

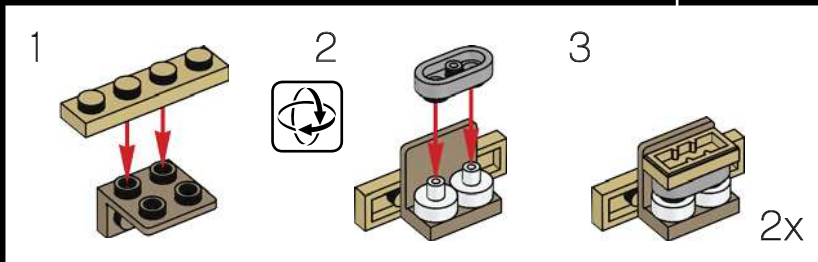
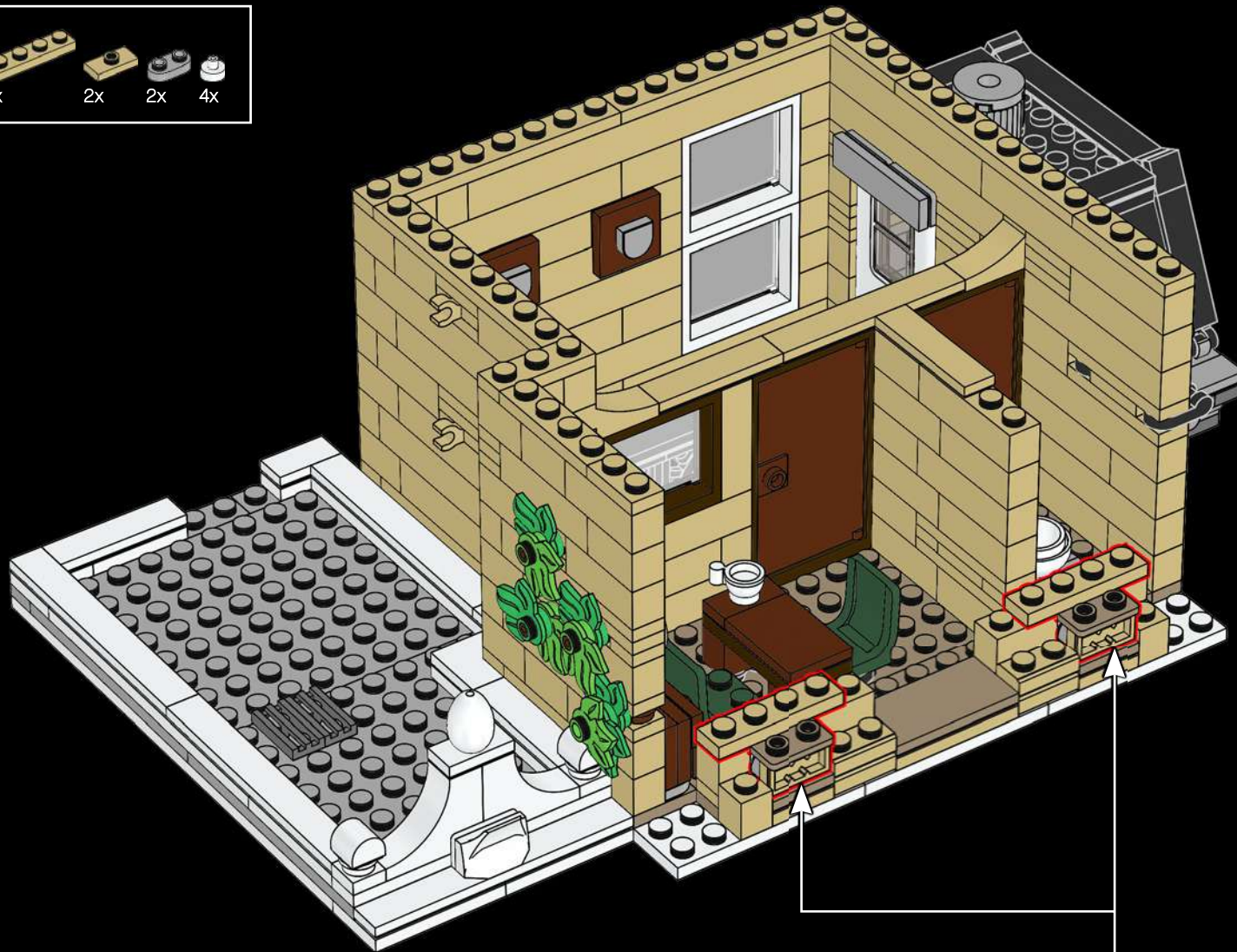

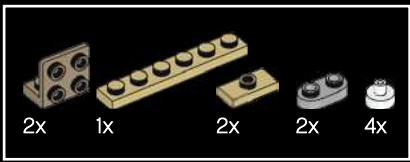

360

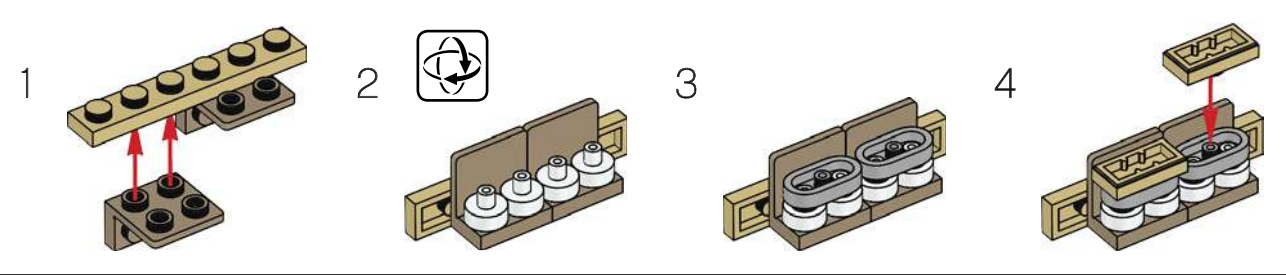

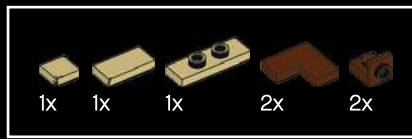

361

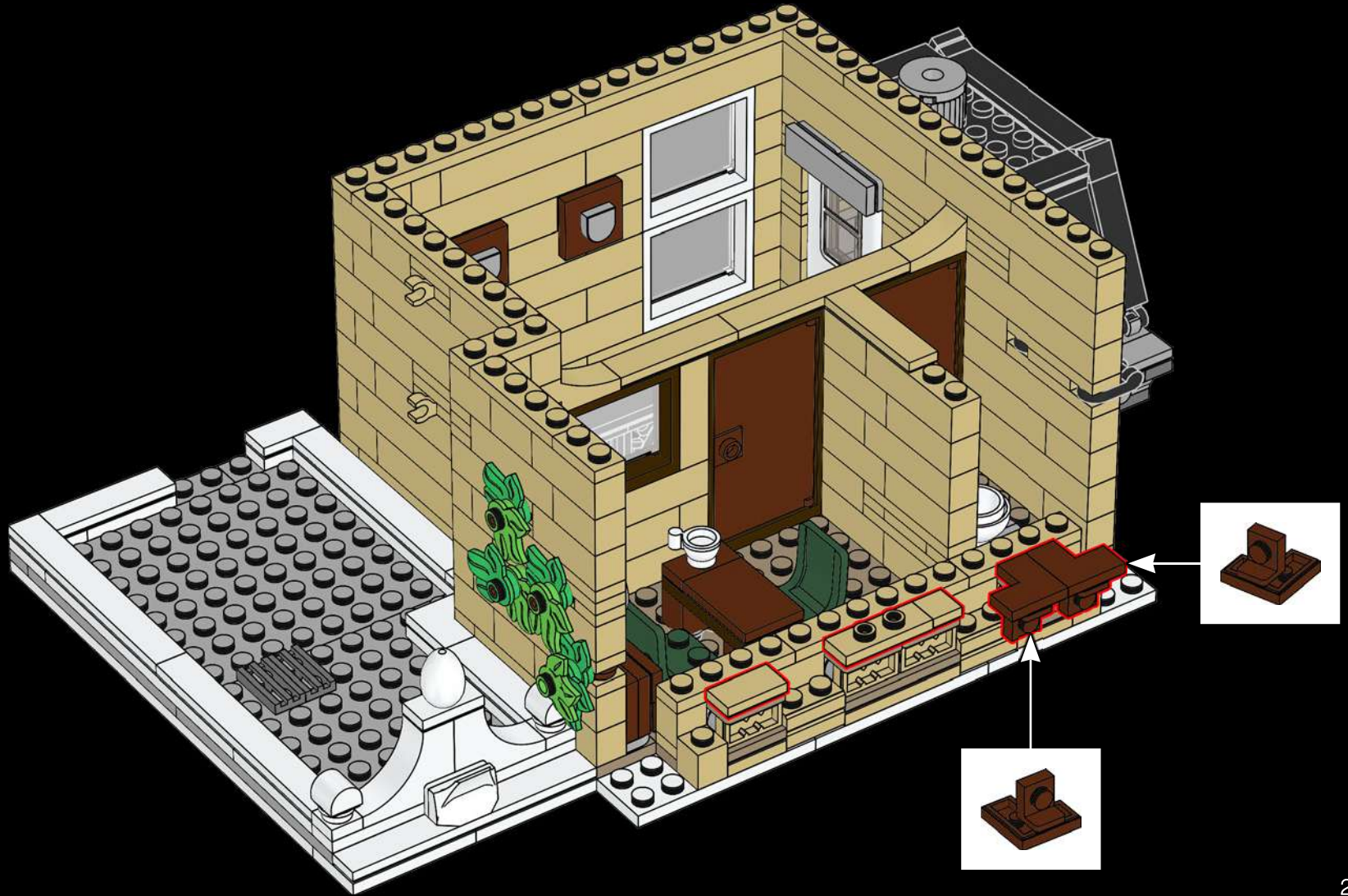

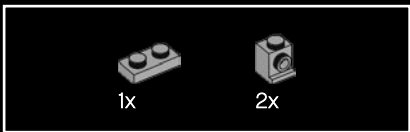

362

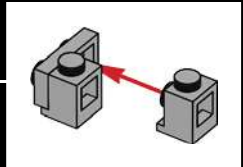
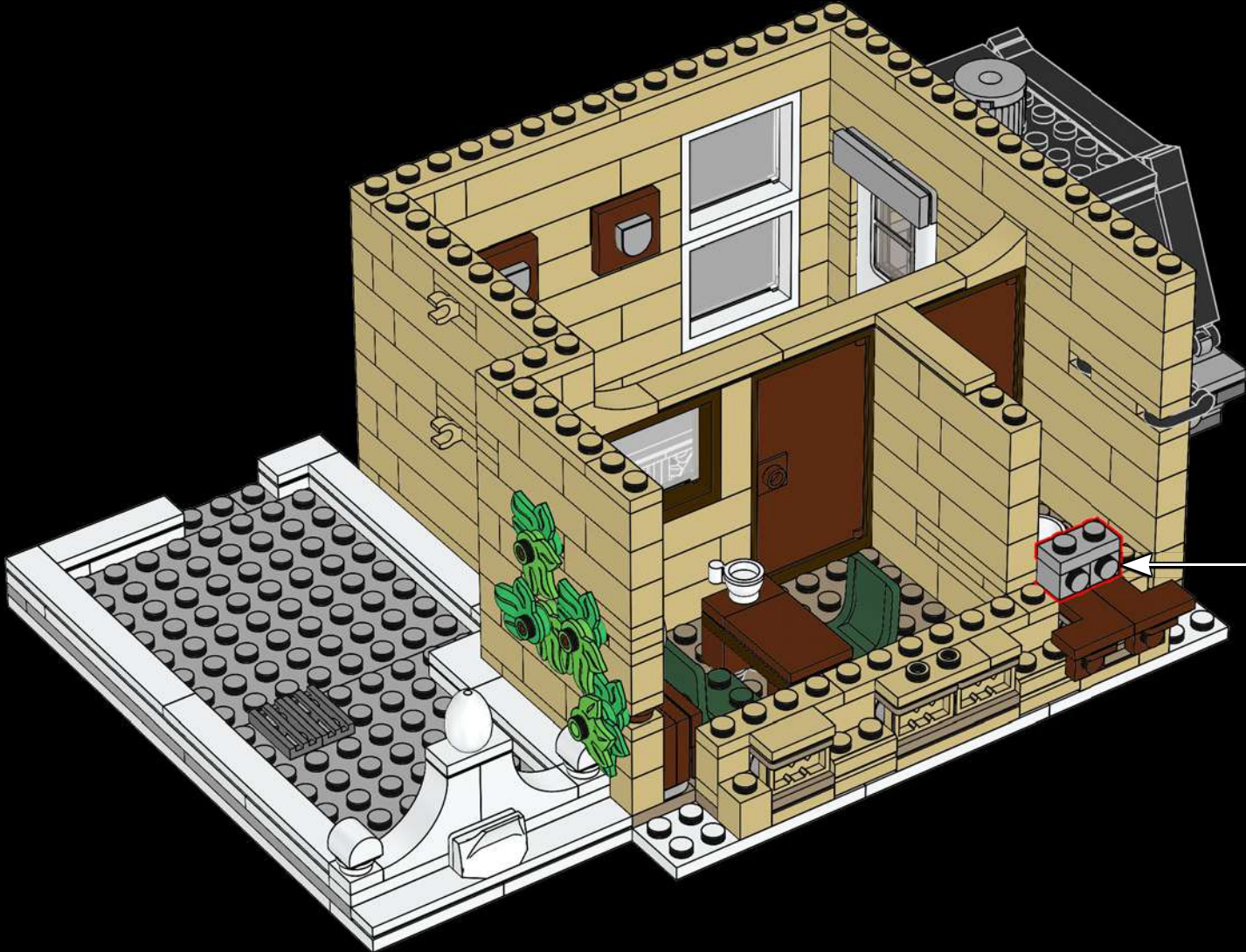

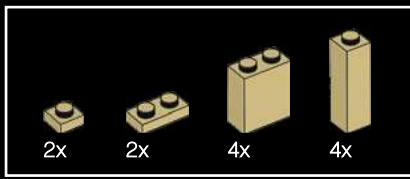

363

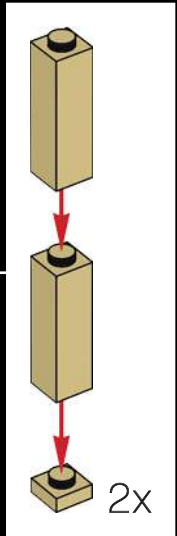
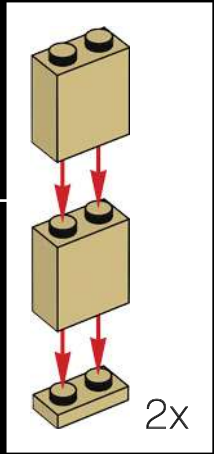

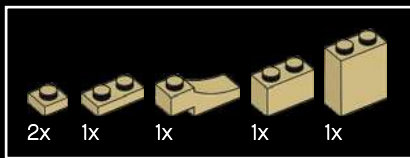

364

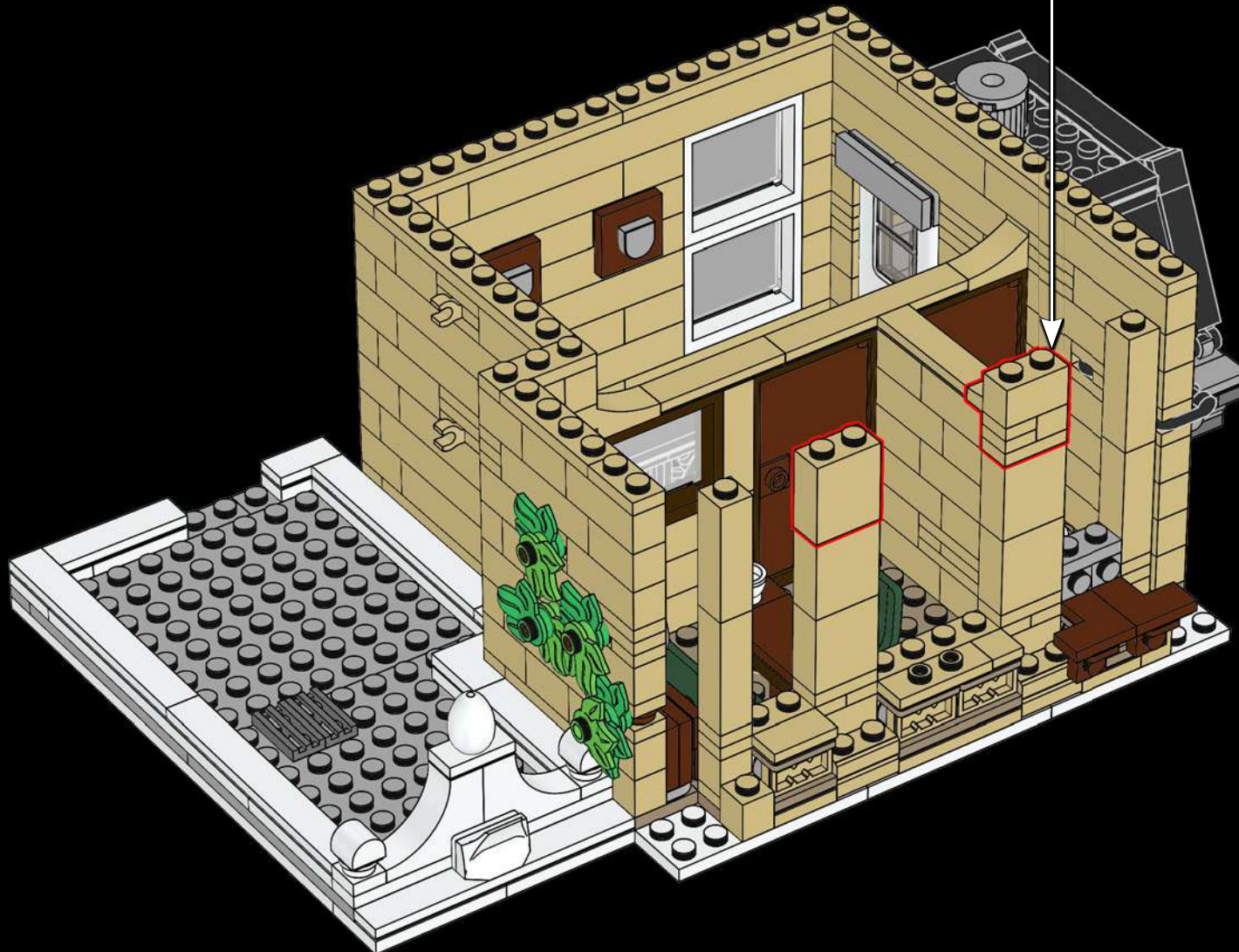
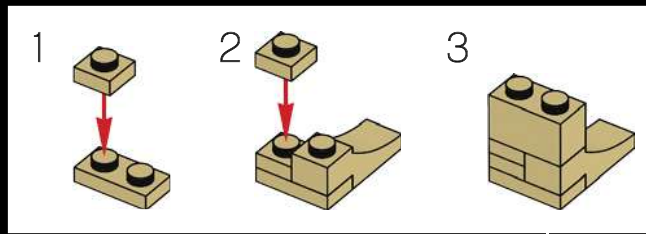



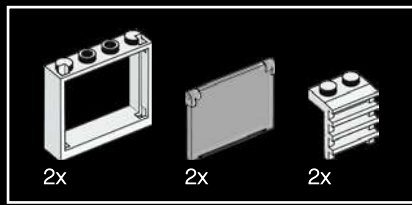

365

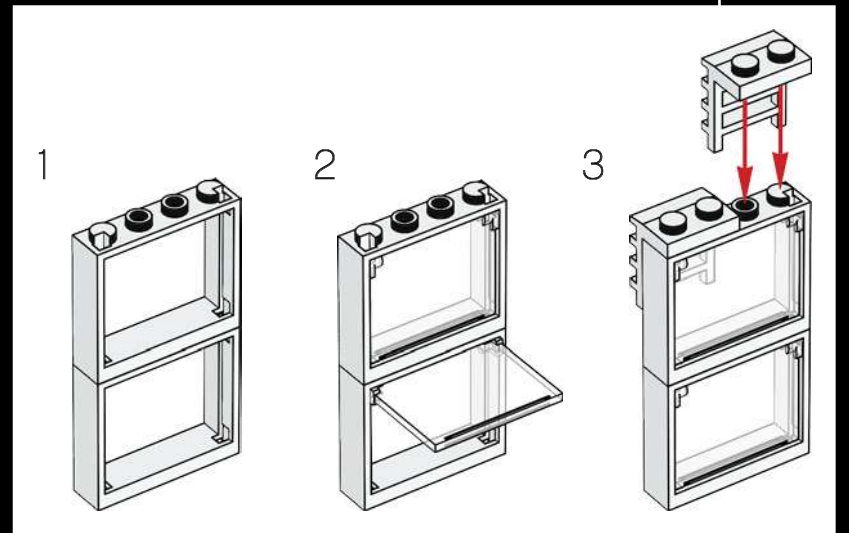
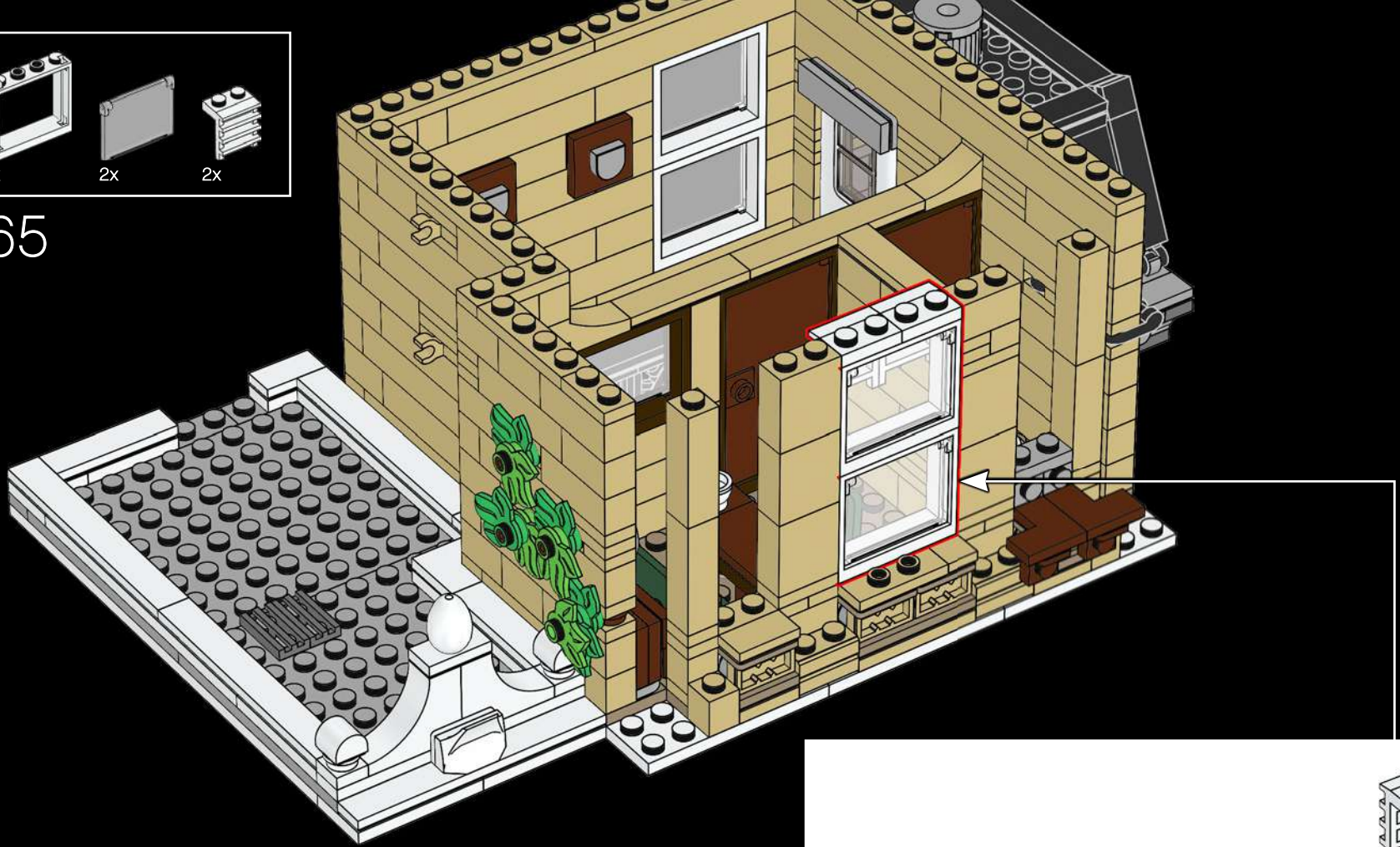

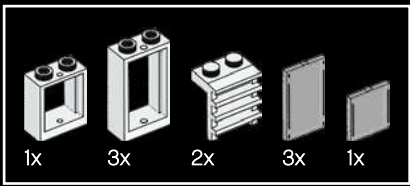

366

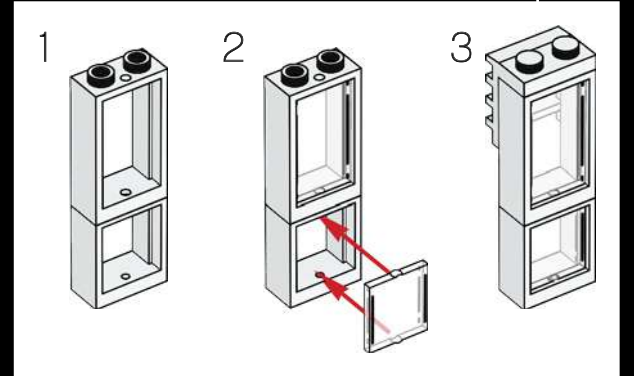
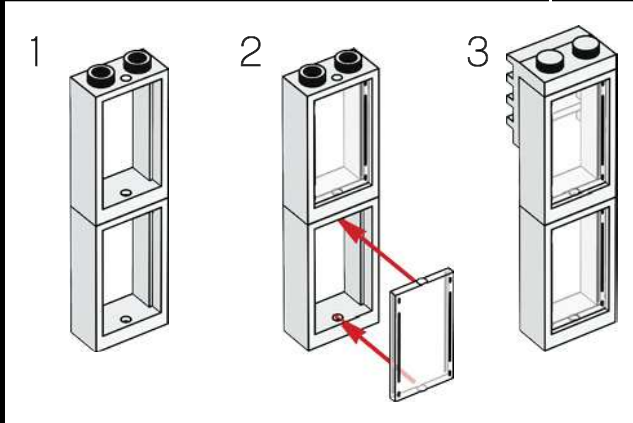

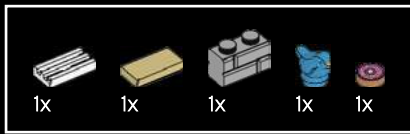

367

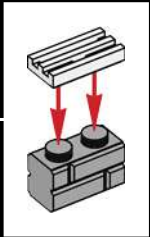
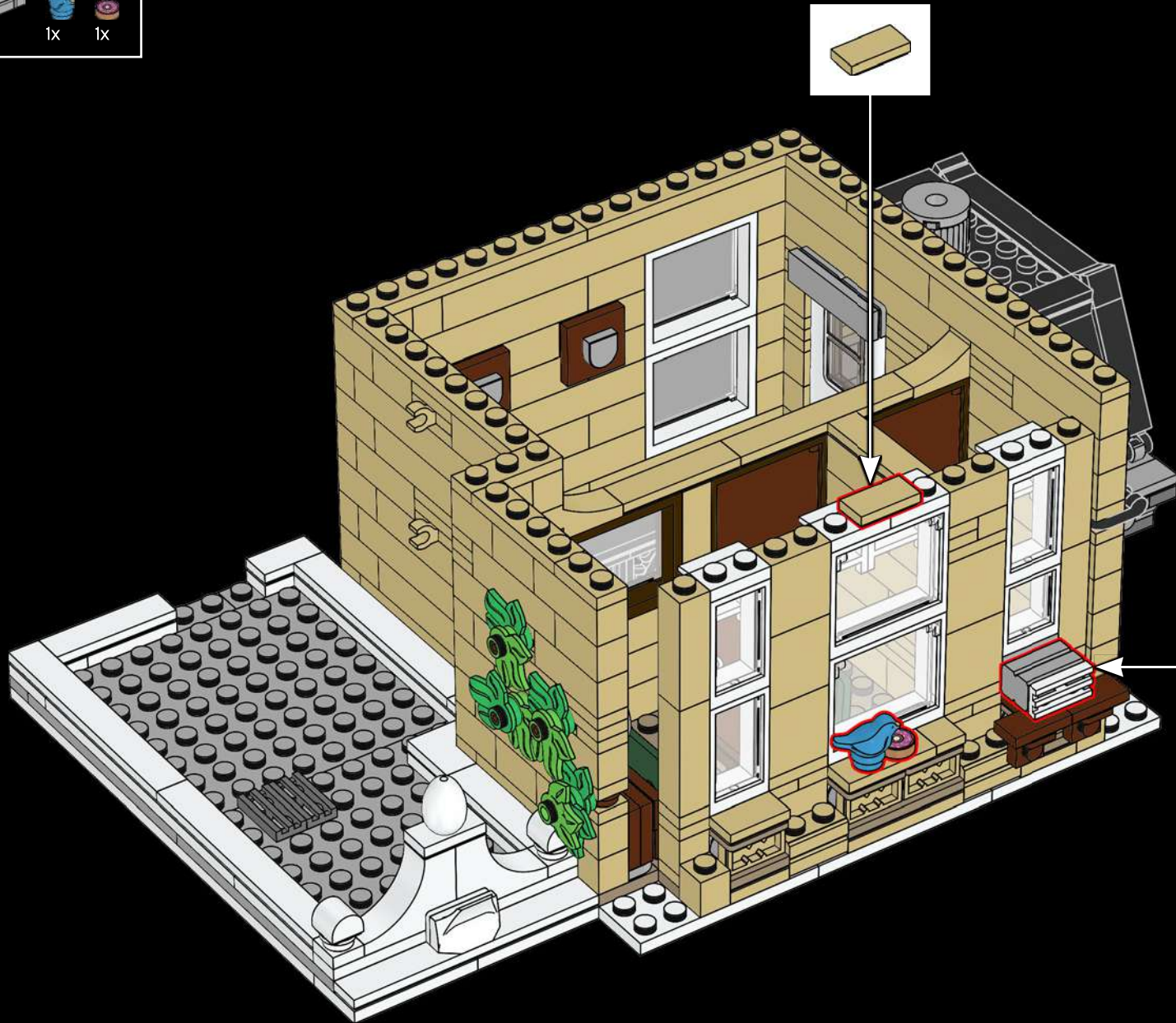

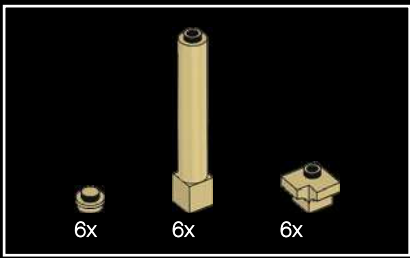

368

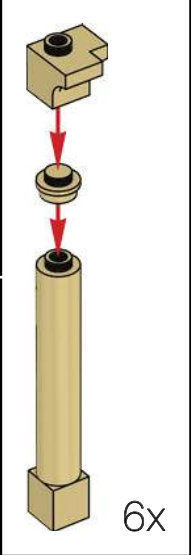
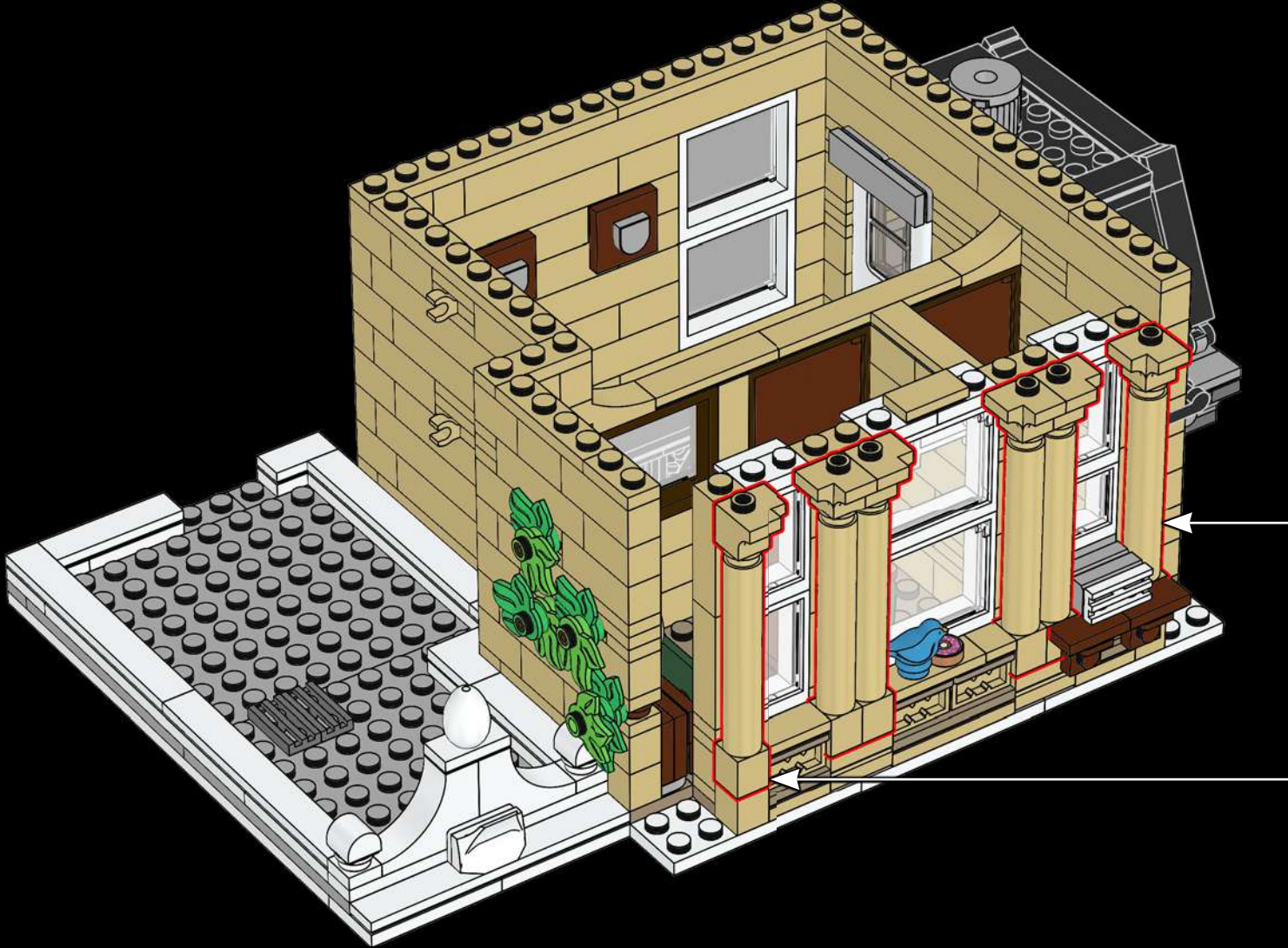

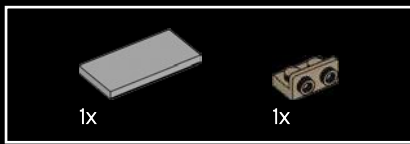

369

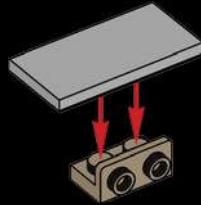

370

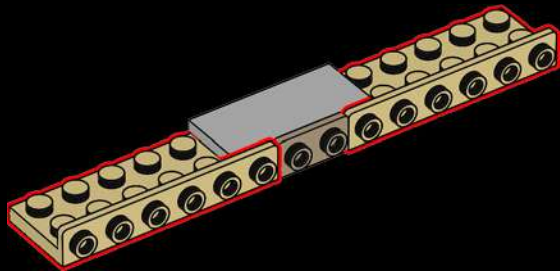

371

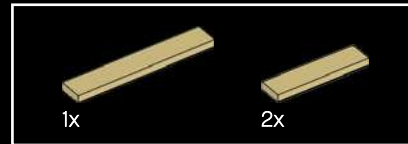
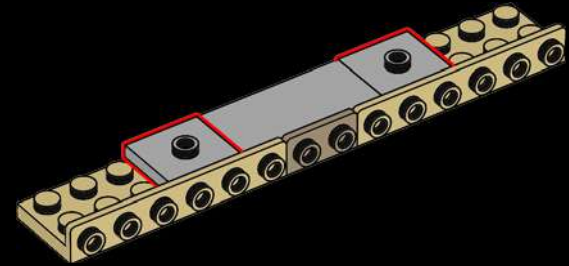

372

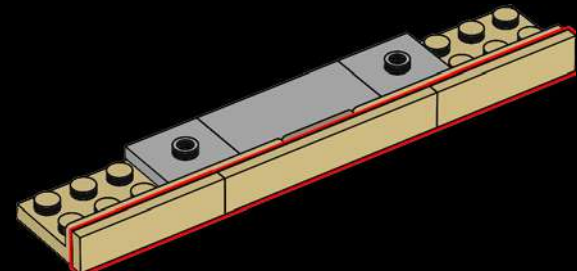

373

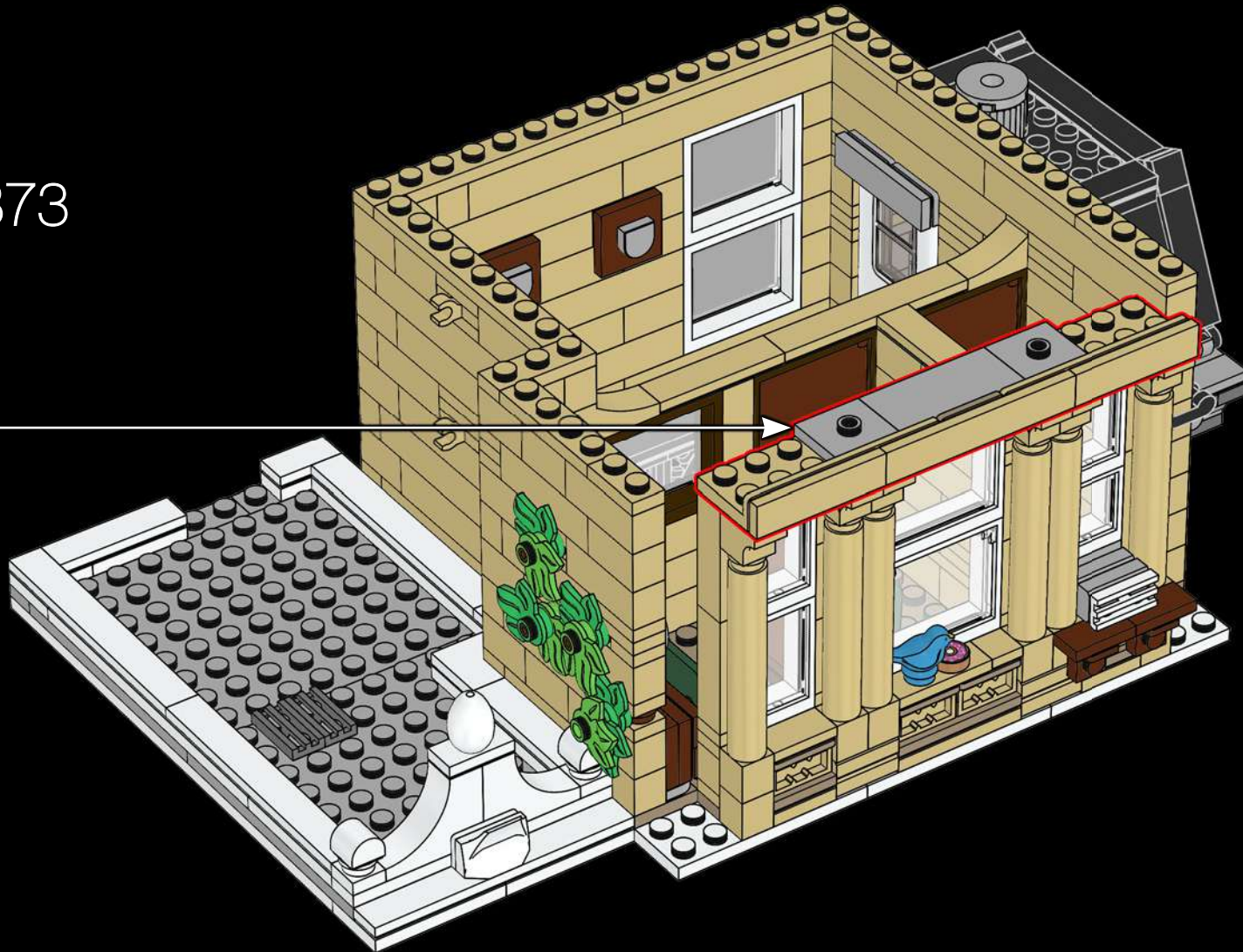

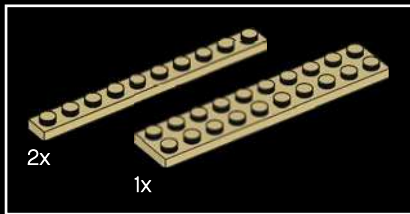
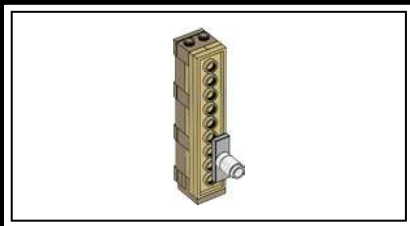

374

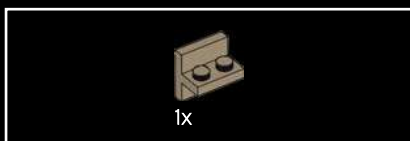
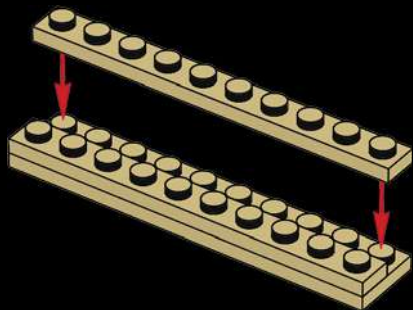

375

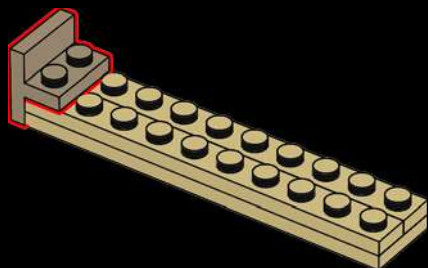

376

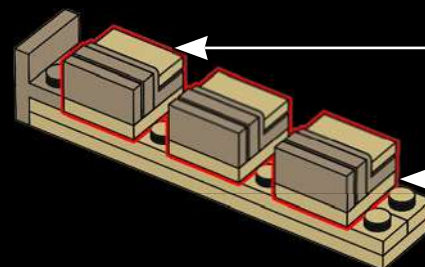
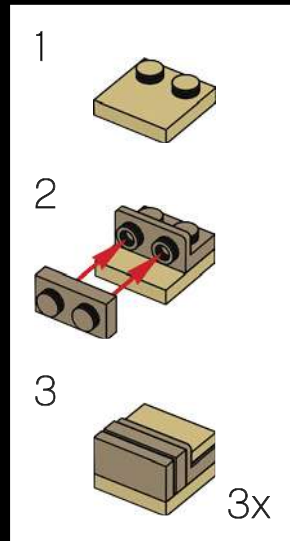

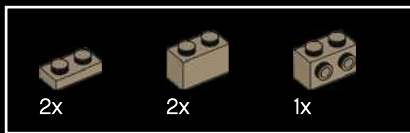

377

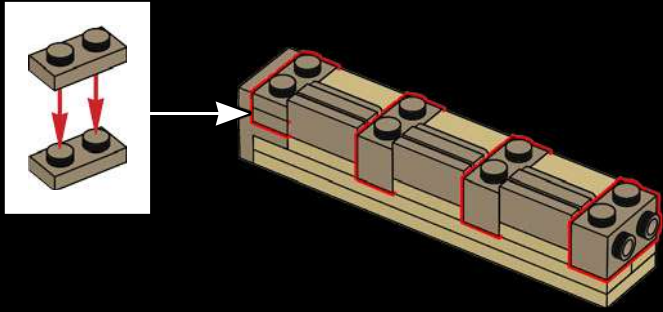

378

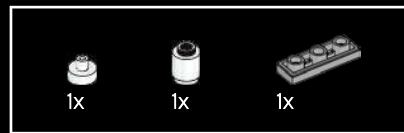
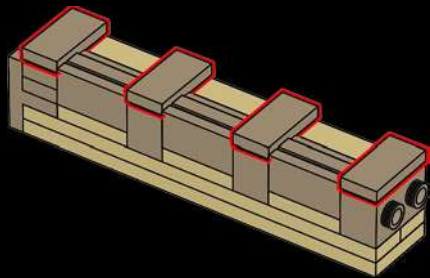

379

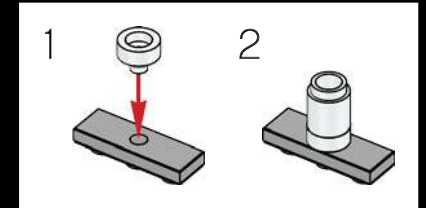
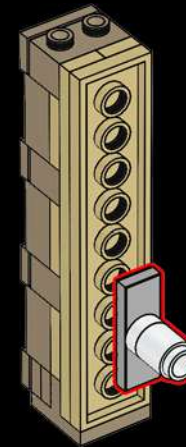



380

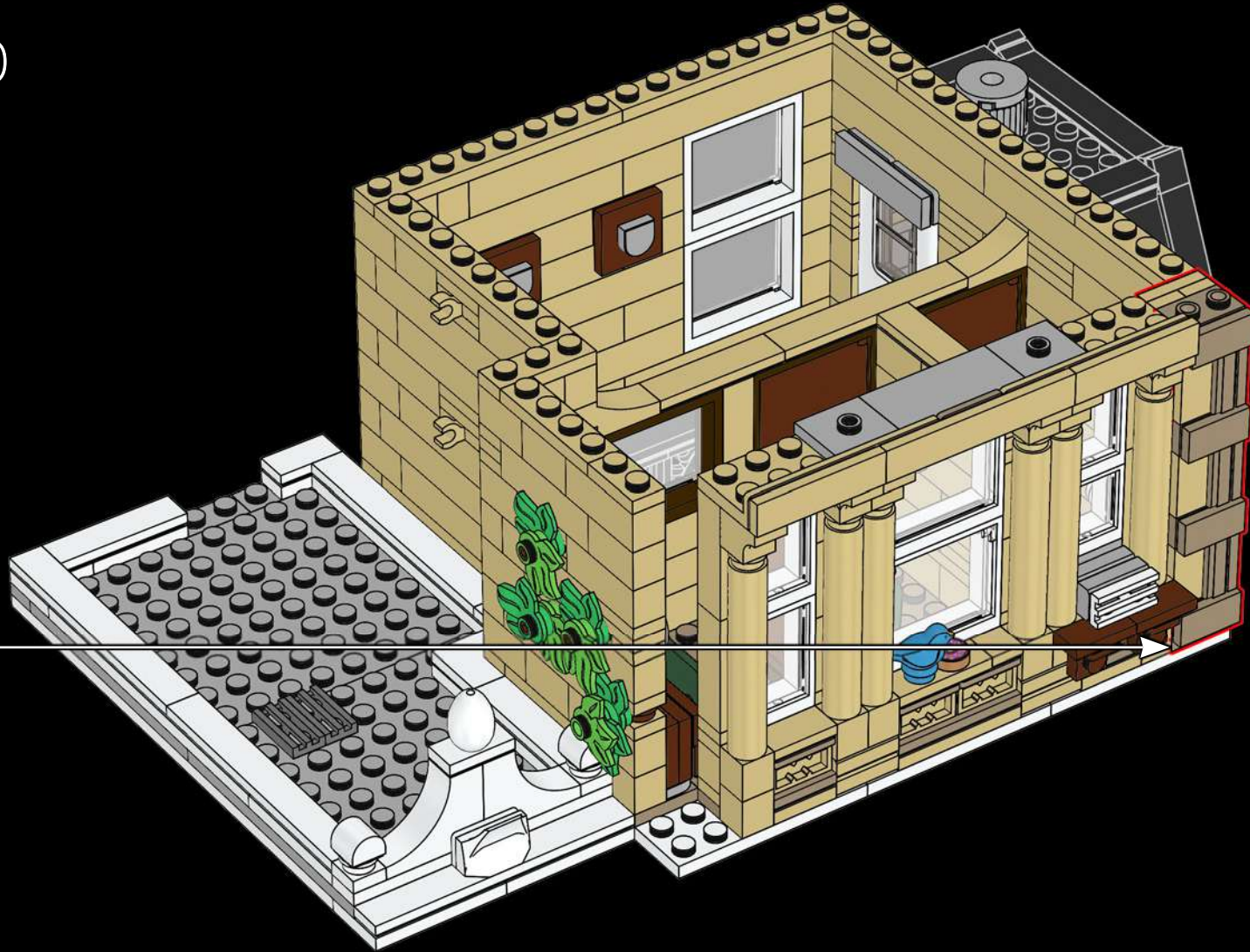

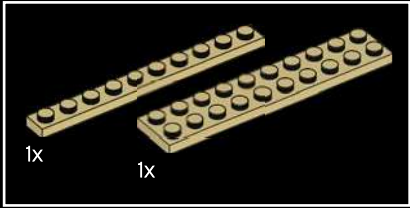
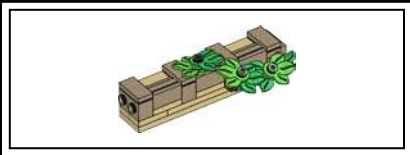

381

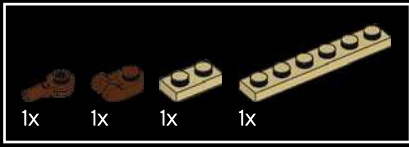
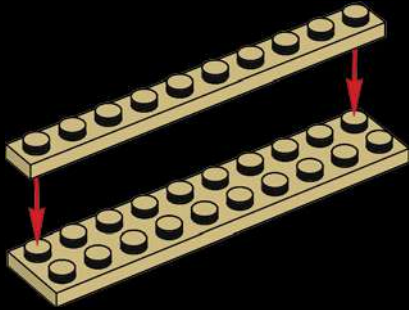

382

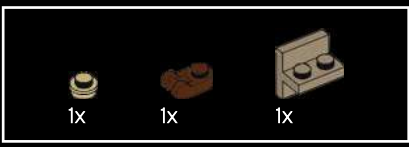
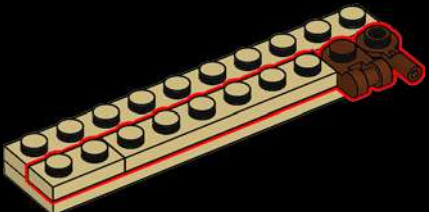

383

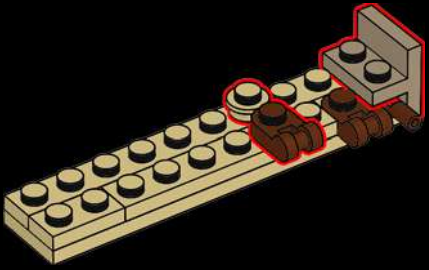

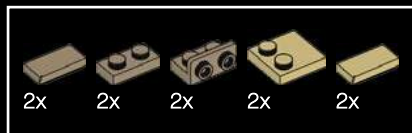

384

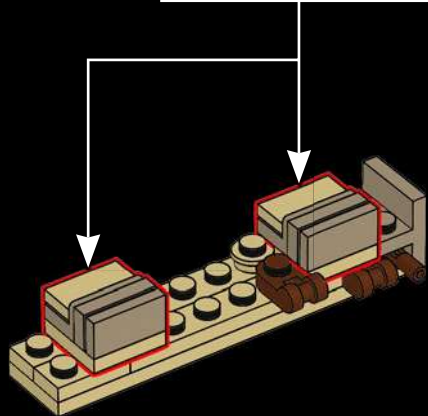
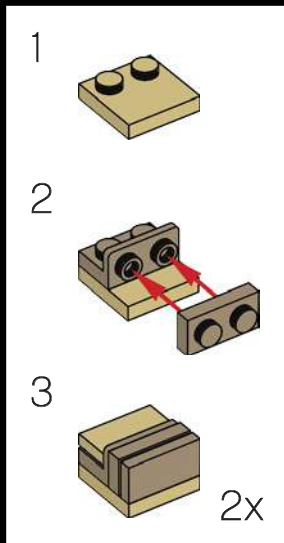

385

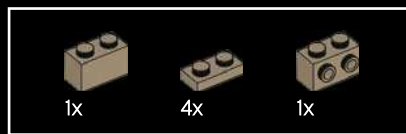
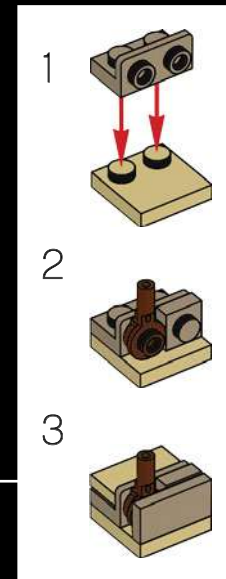
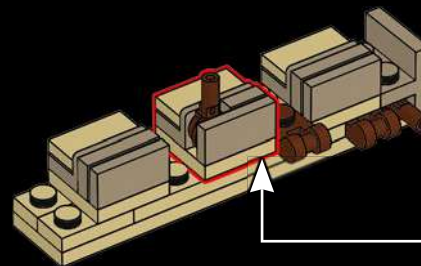

386

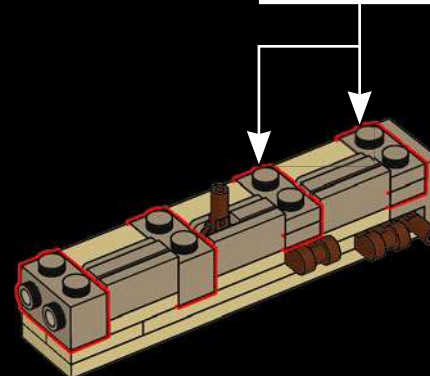
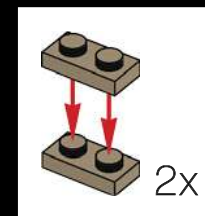



387

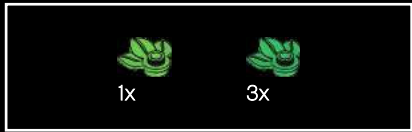
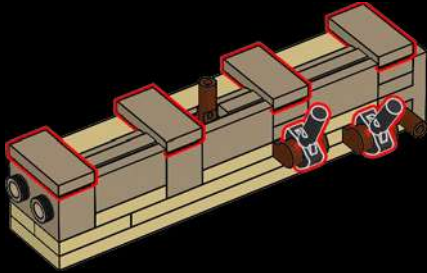

388

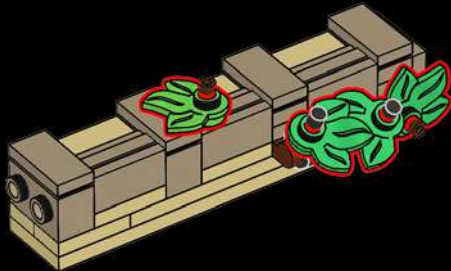

389

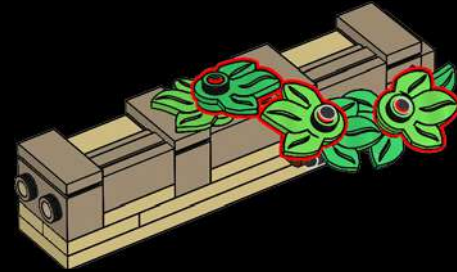

390

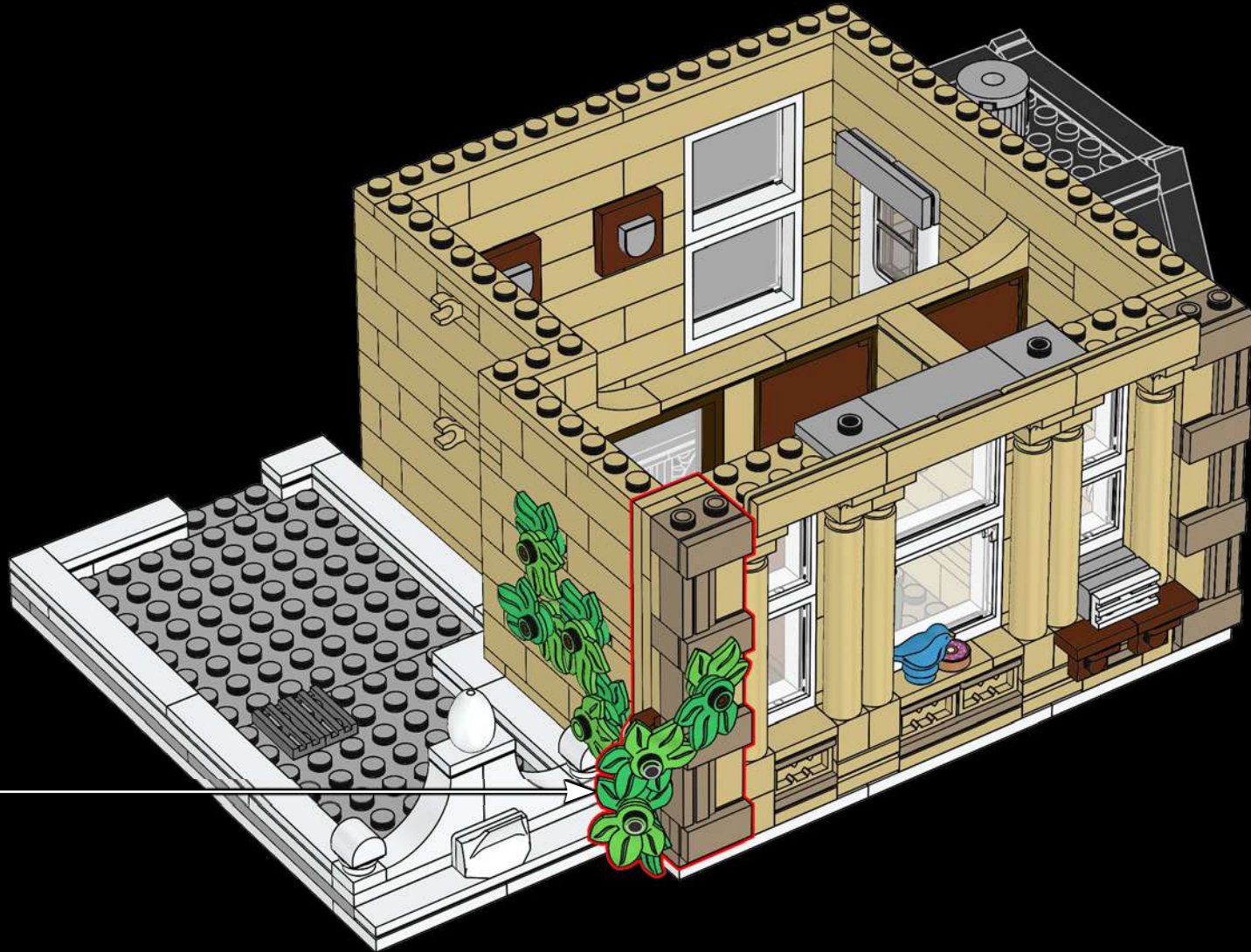

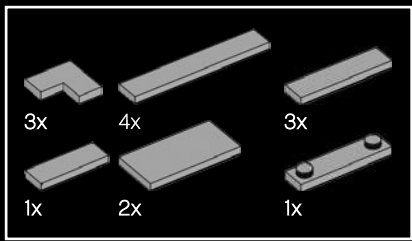

391



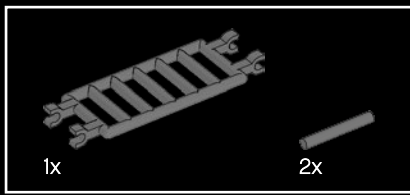

392

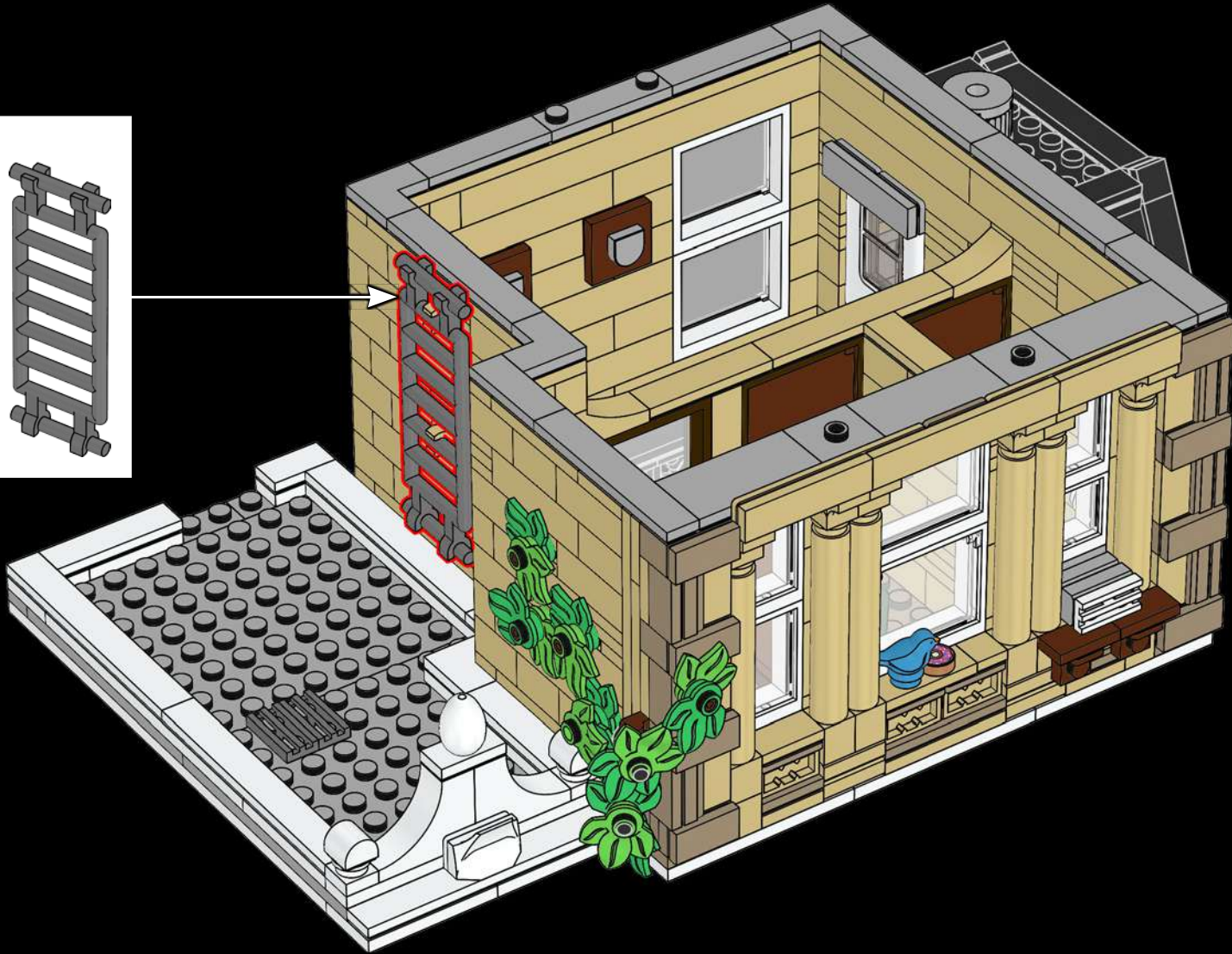
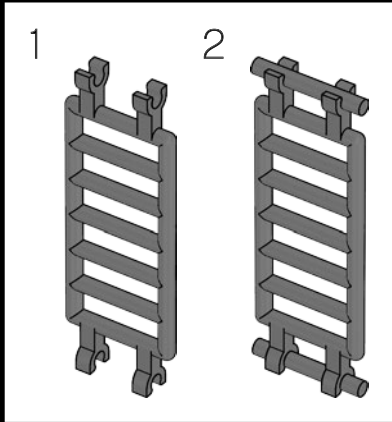

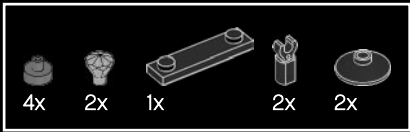

393

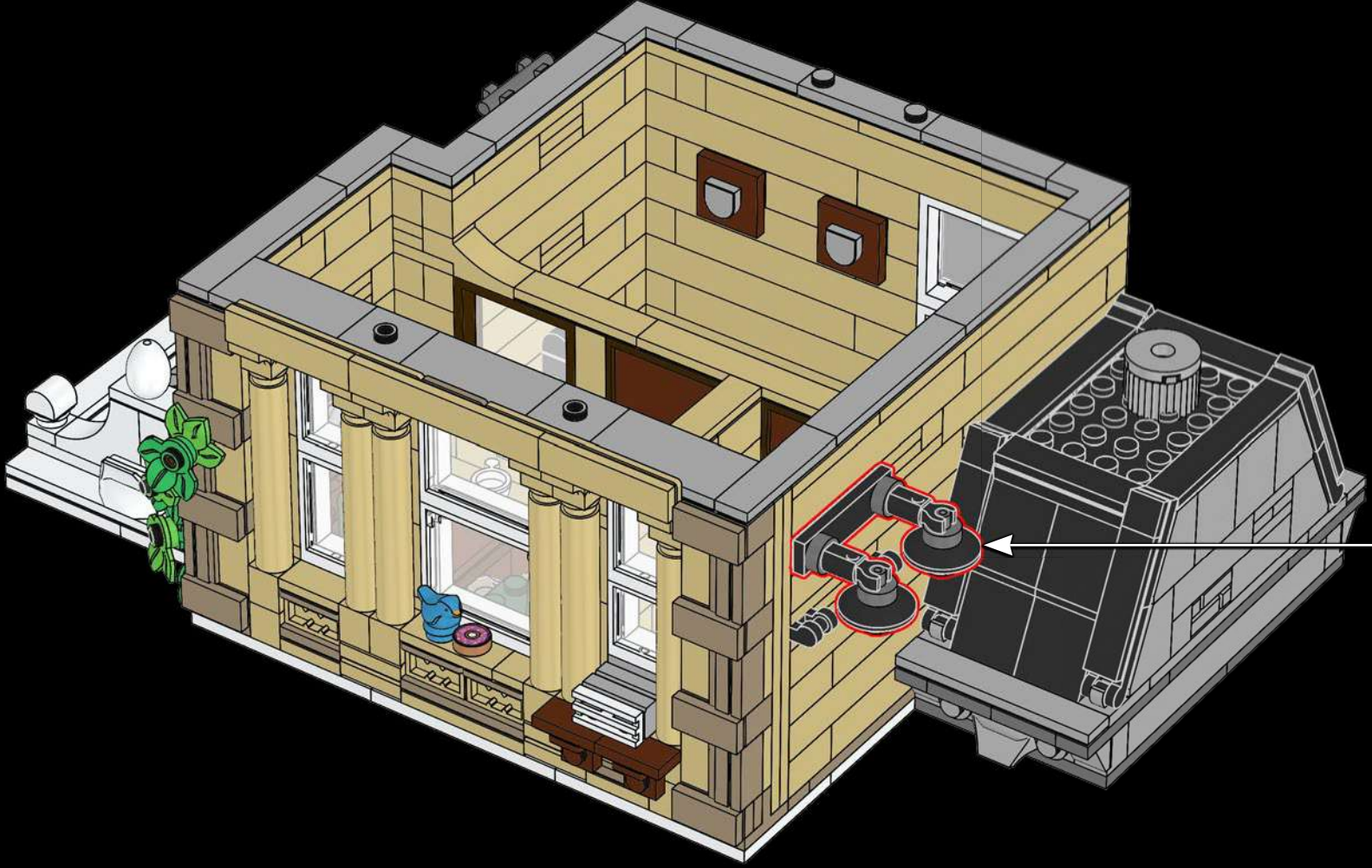
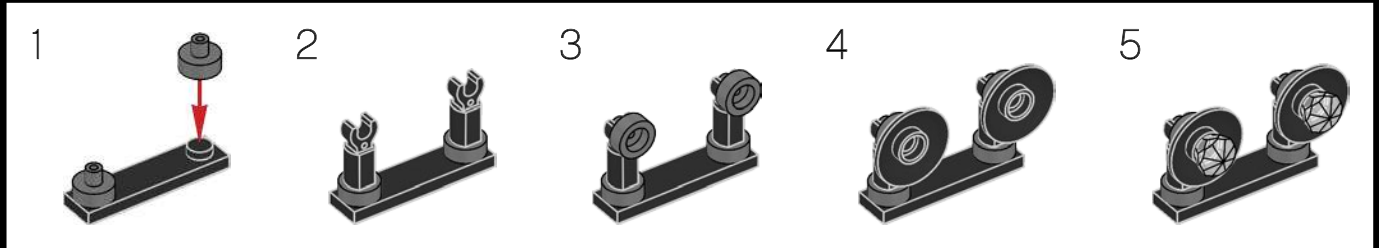



394

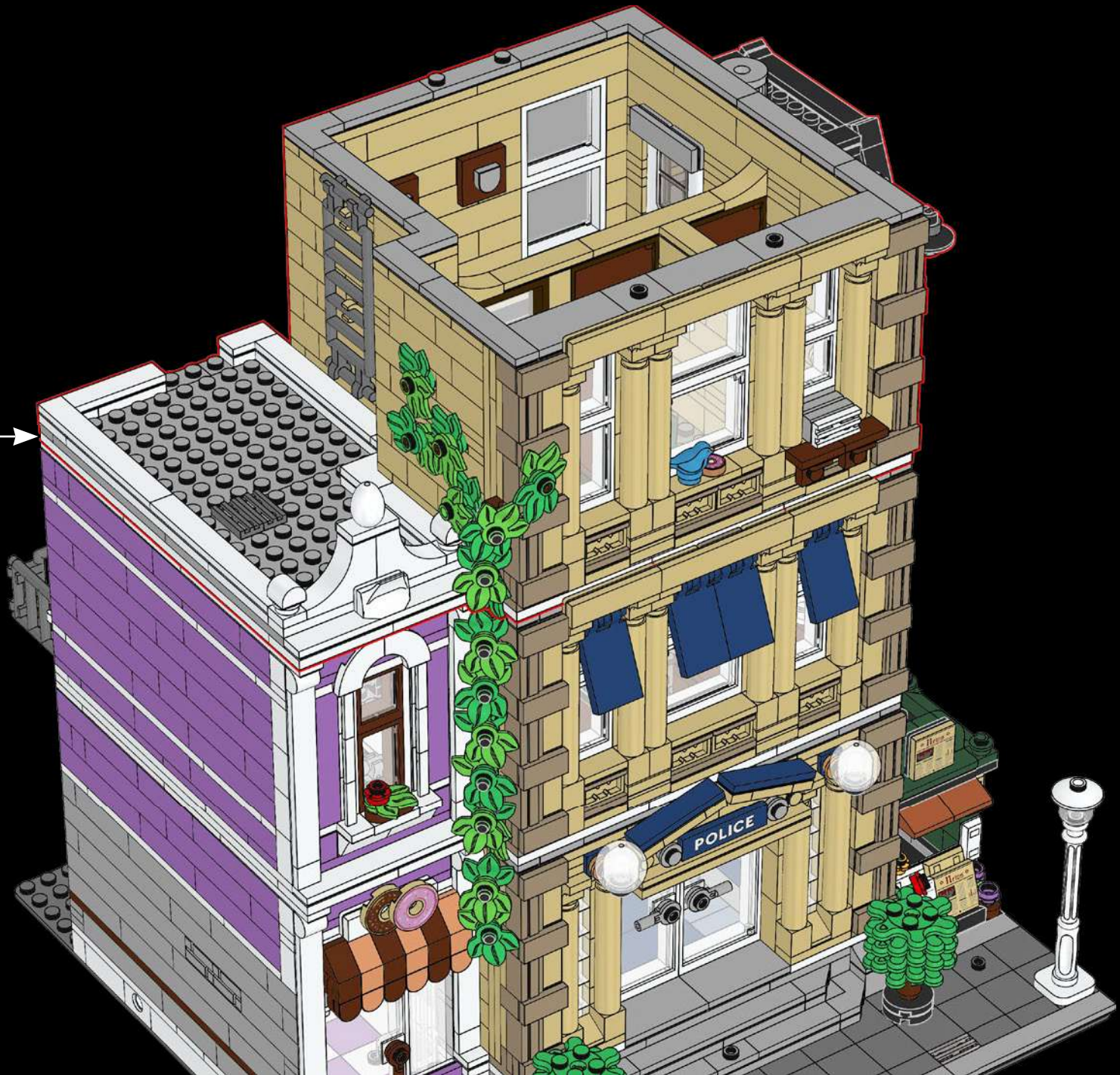

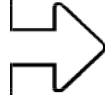

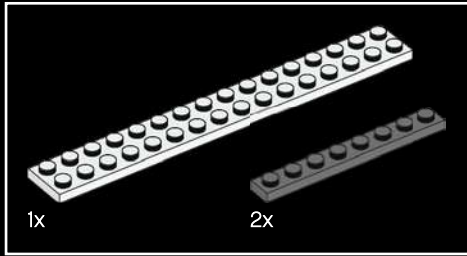
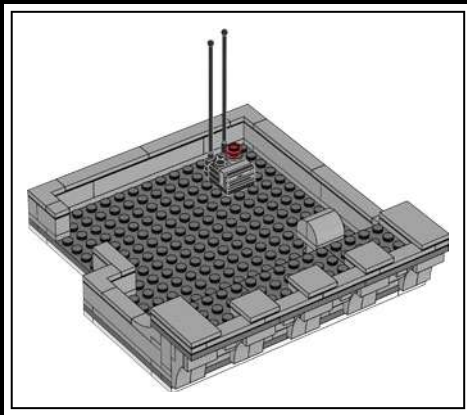

395

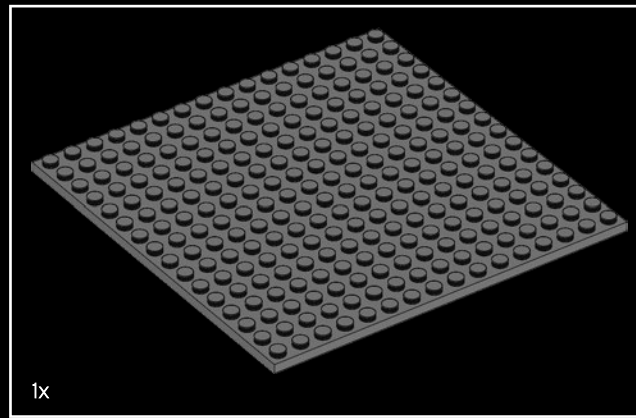
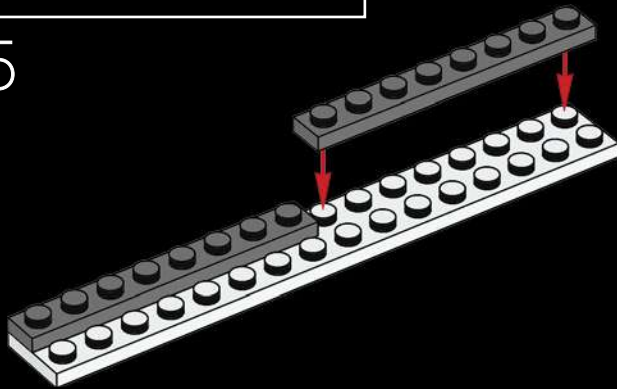

396

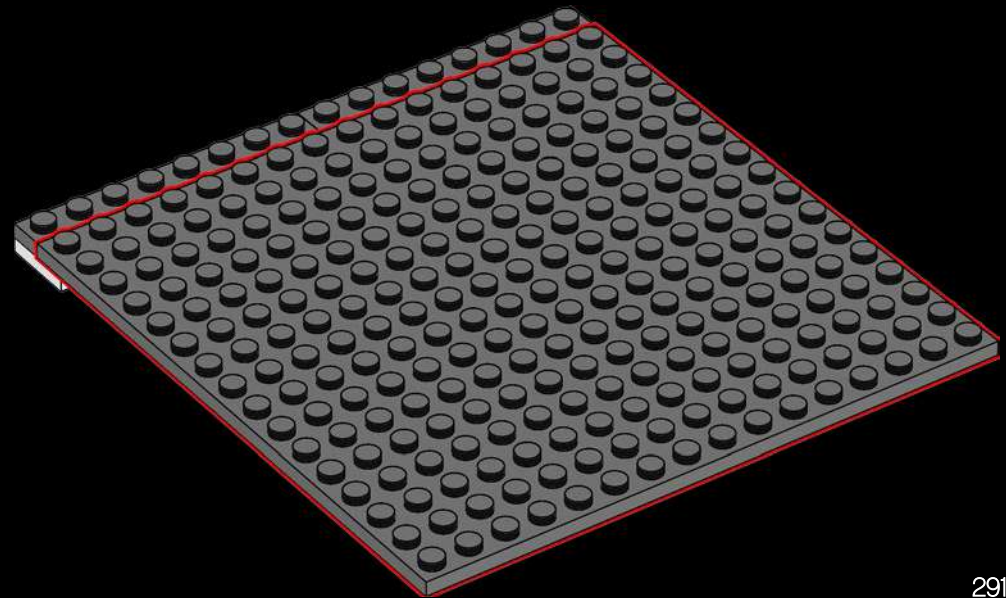

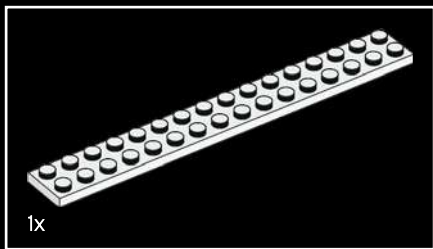

397

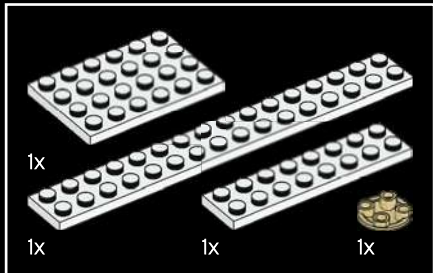
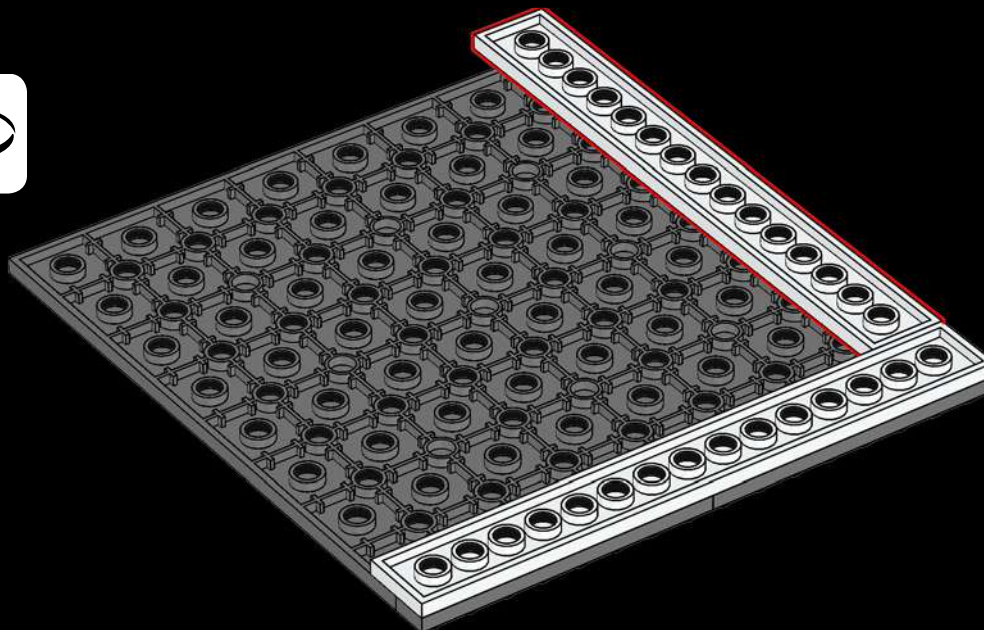

398

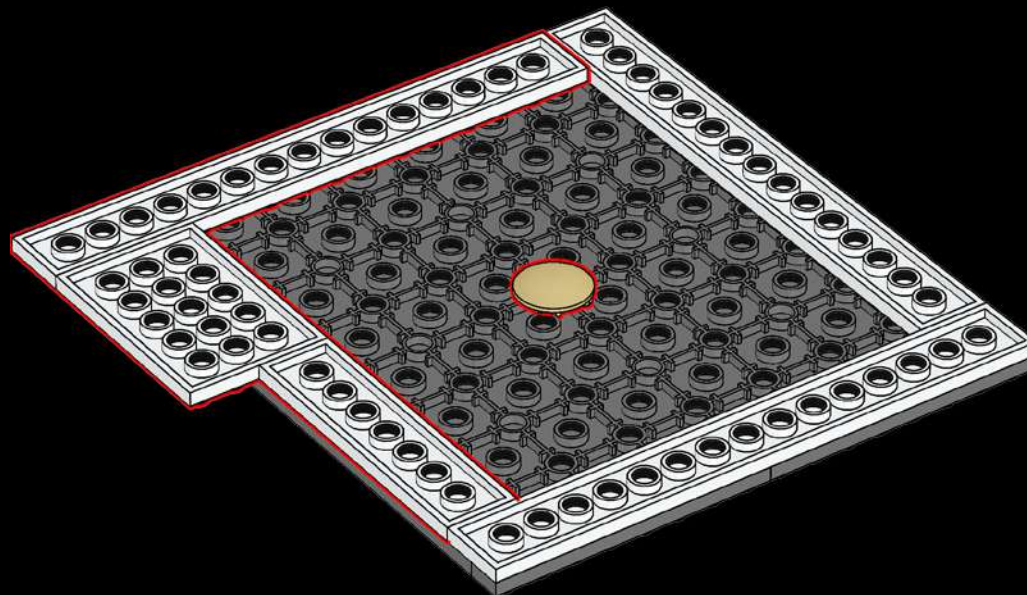

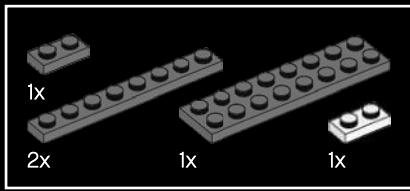

399

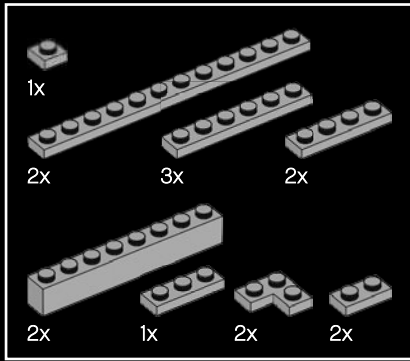
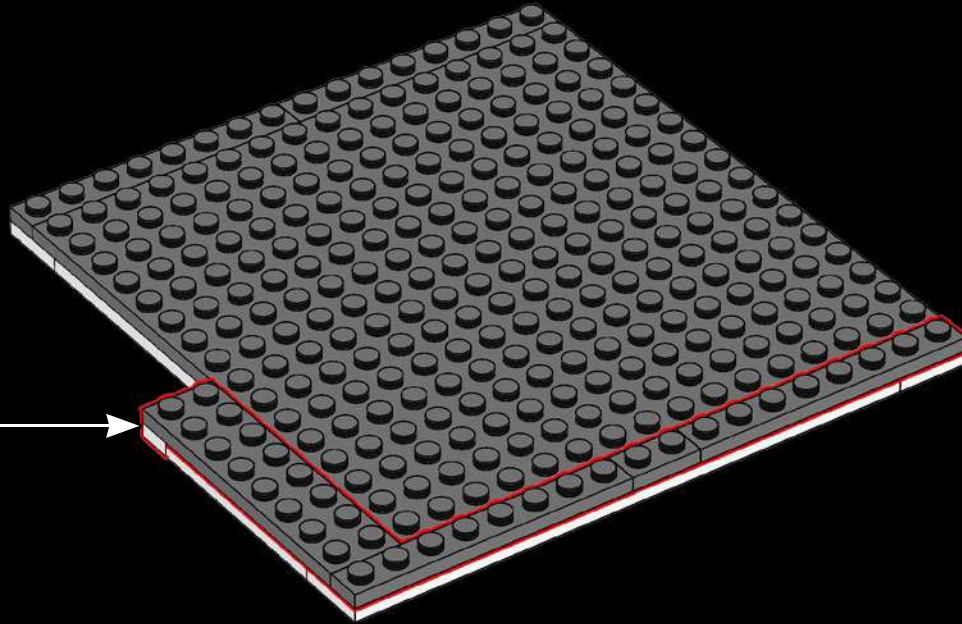
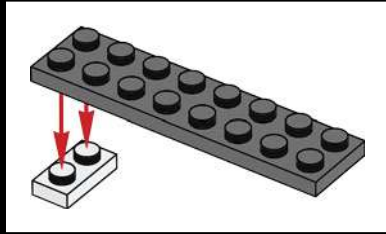

400

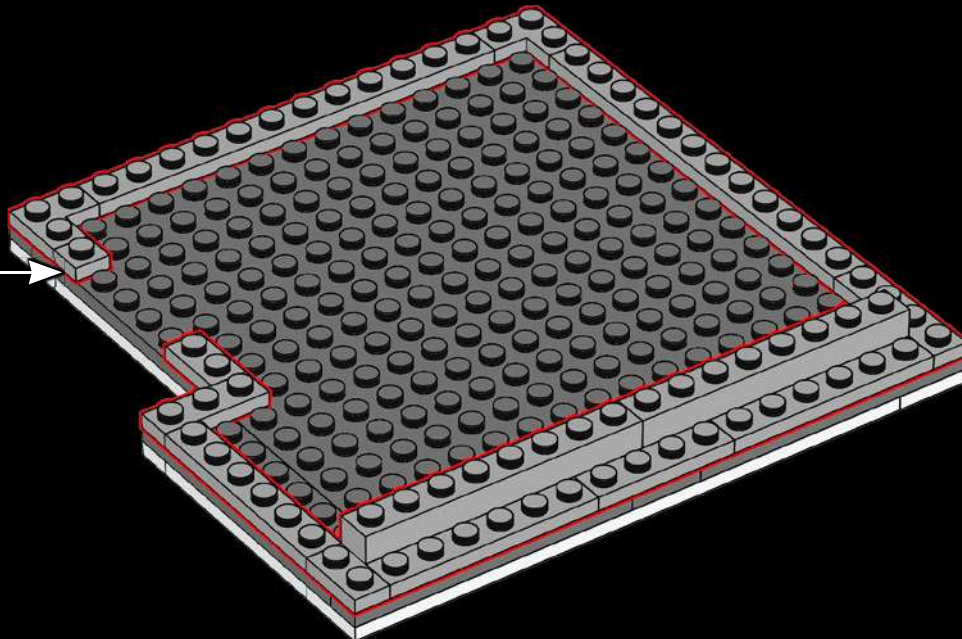
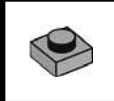

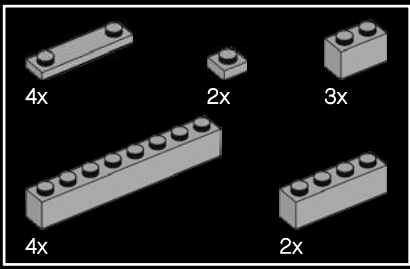

401

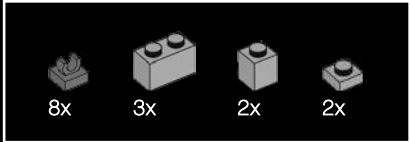
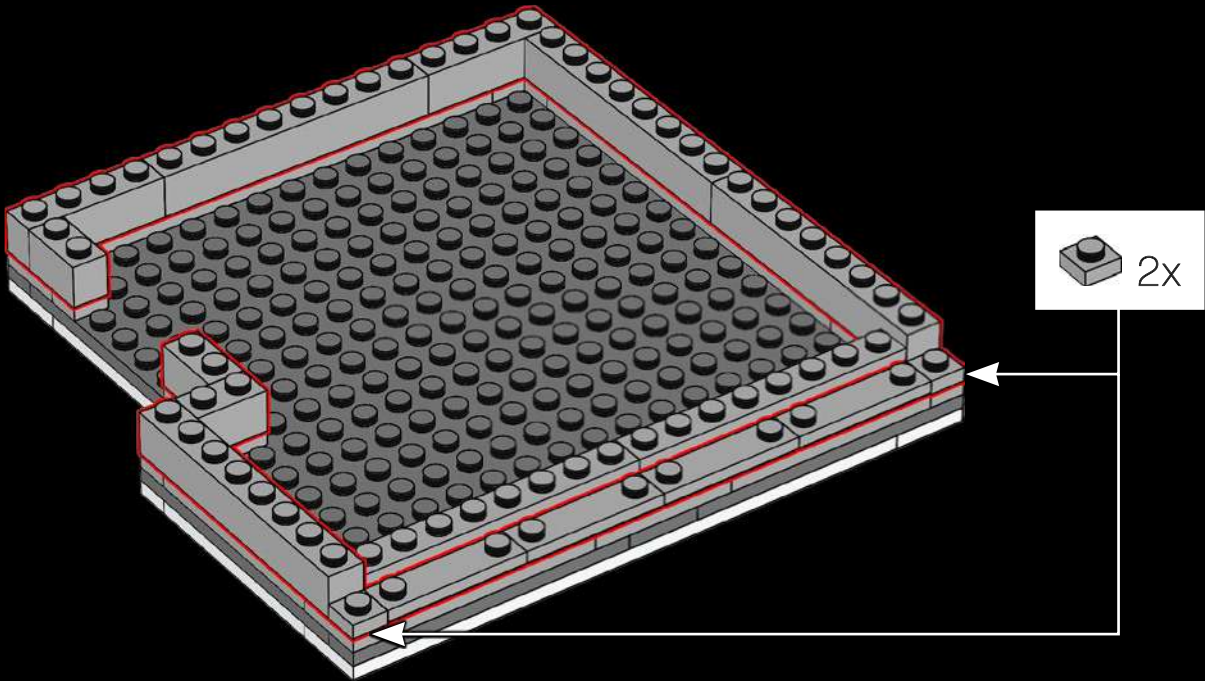

402

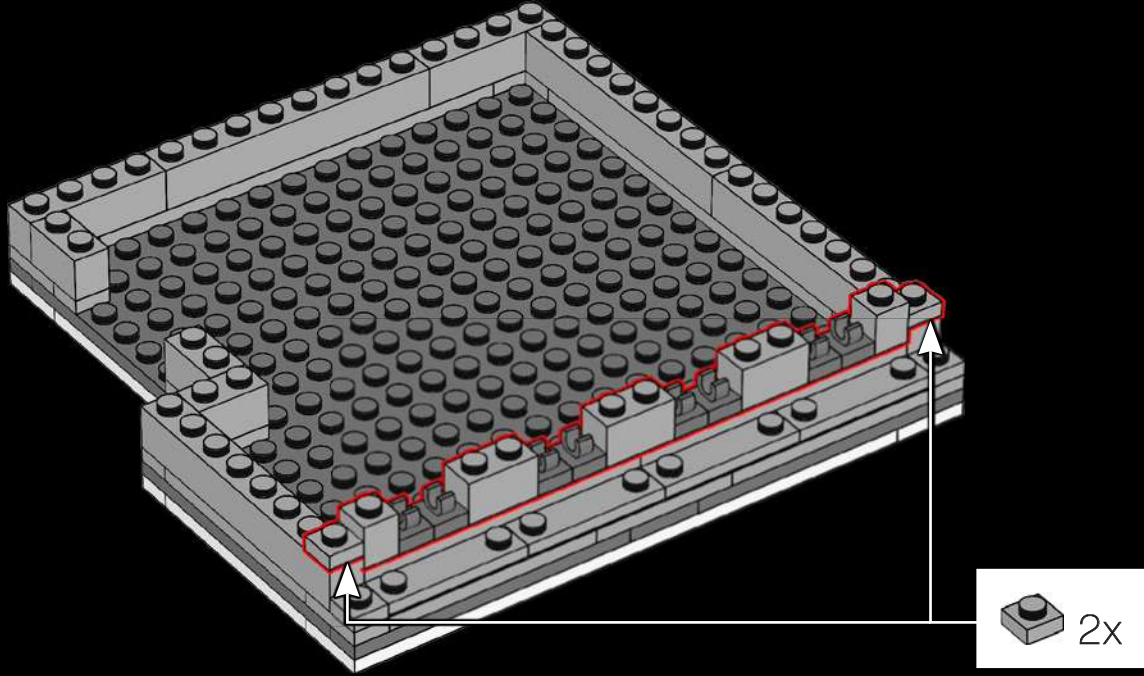

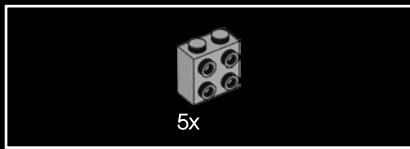

403

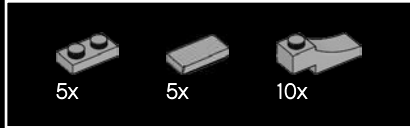
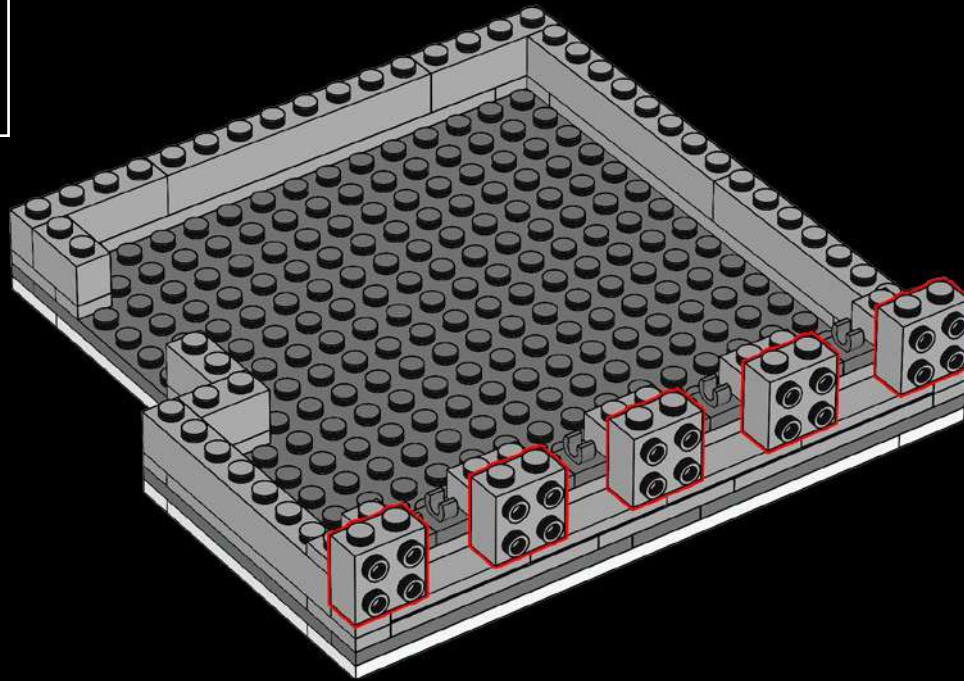

404

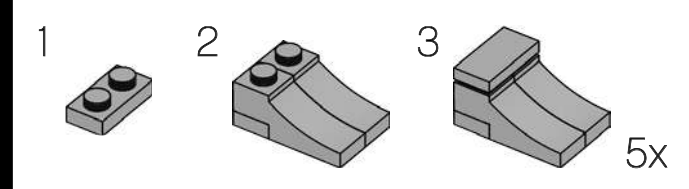
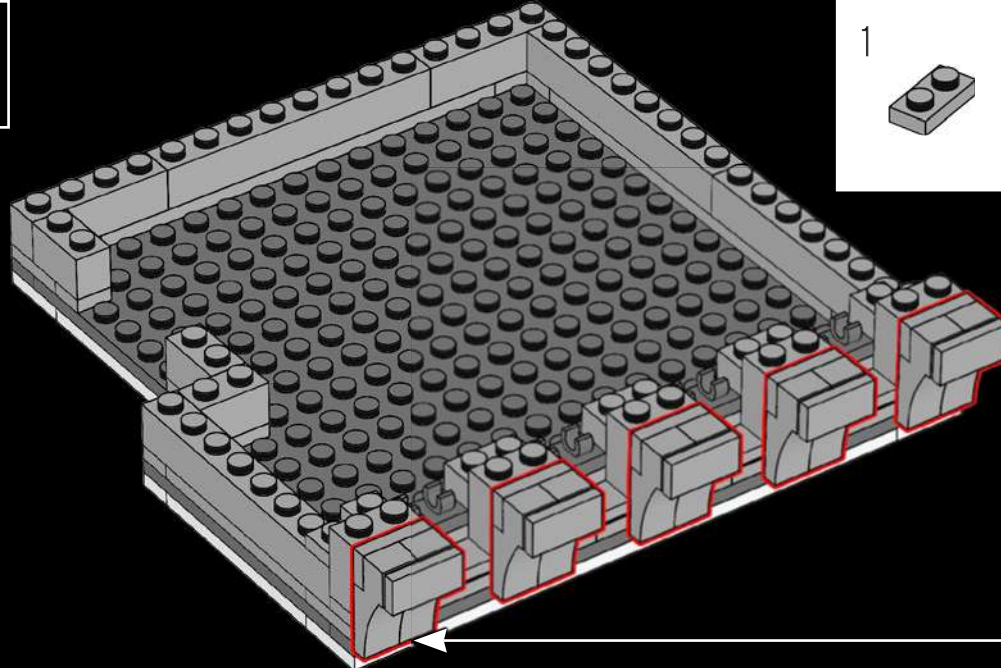

Did you notice the cornice is crafted using a familiar animal head flipped upside down?

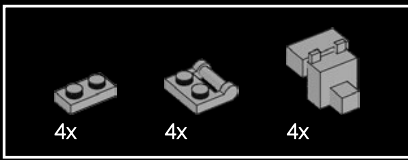

405

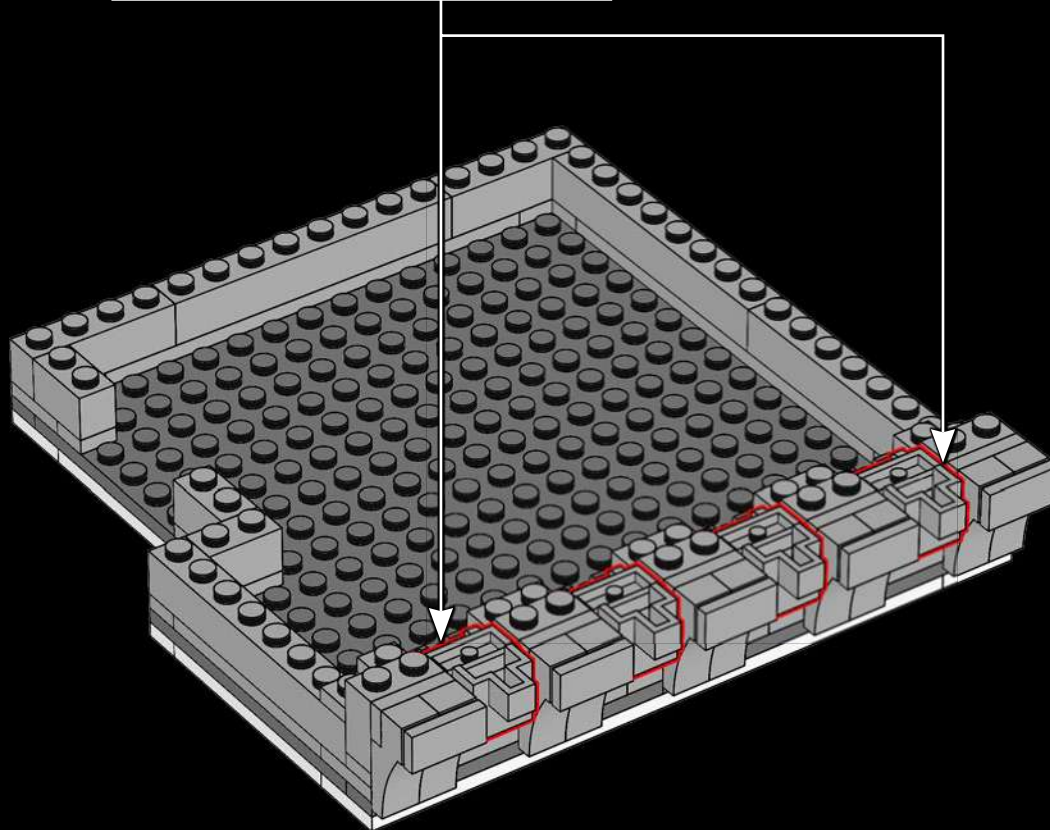
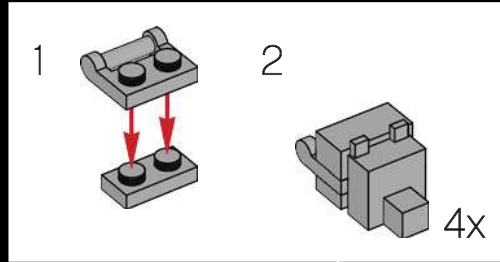



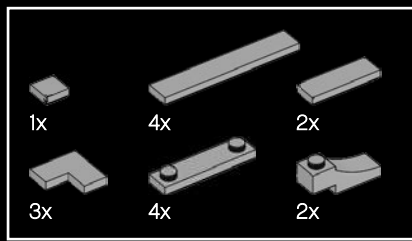

406

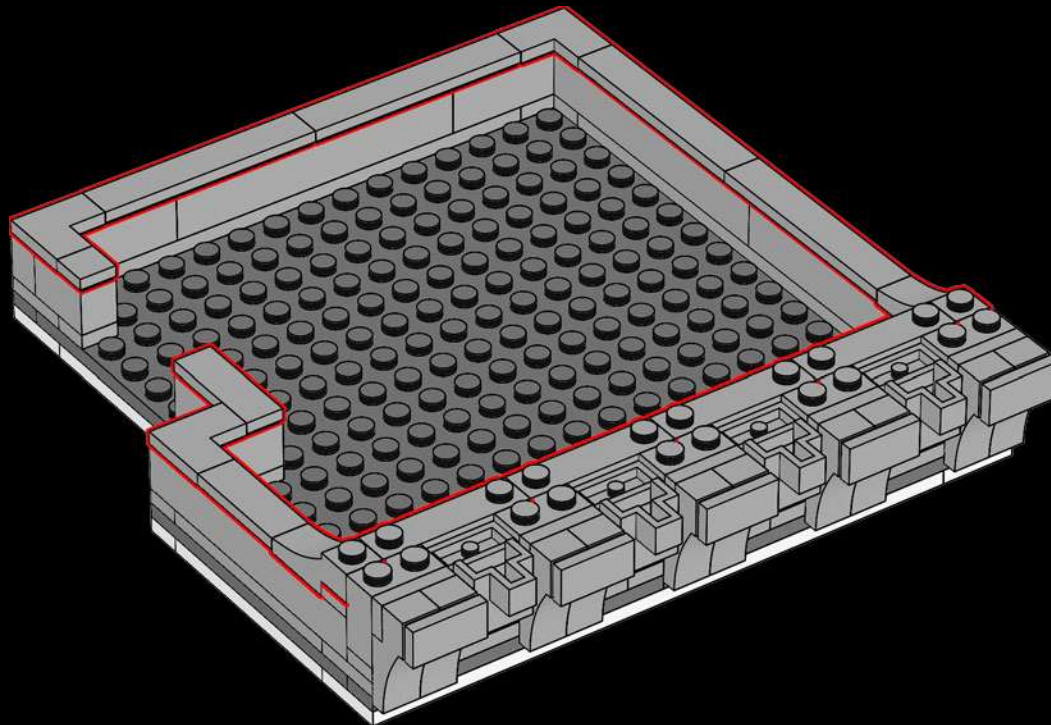

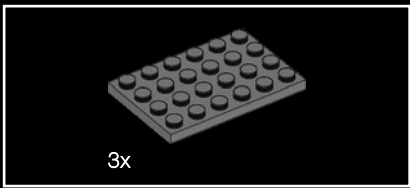

407

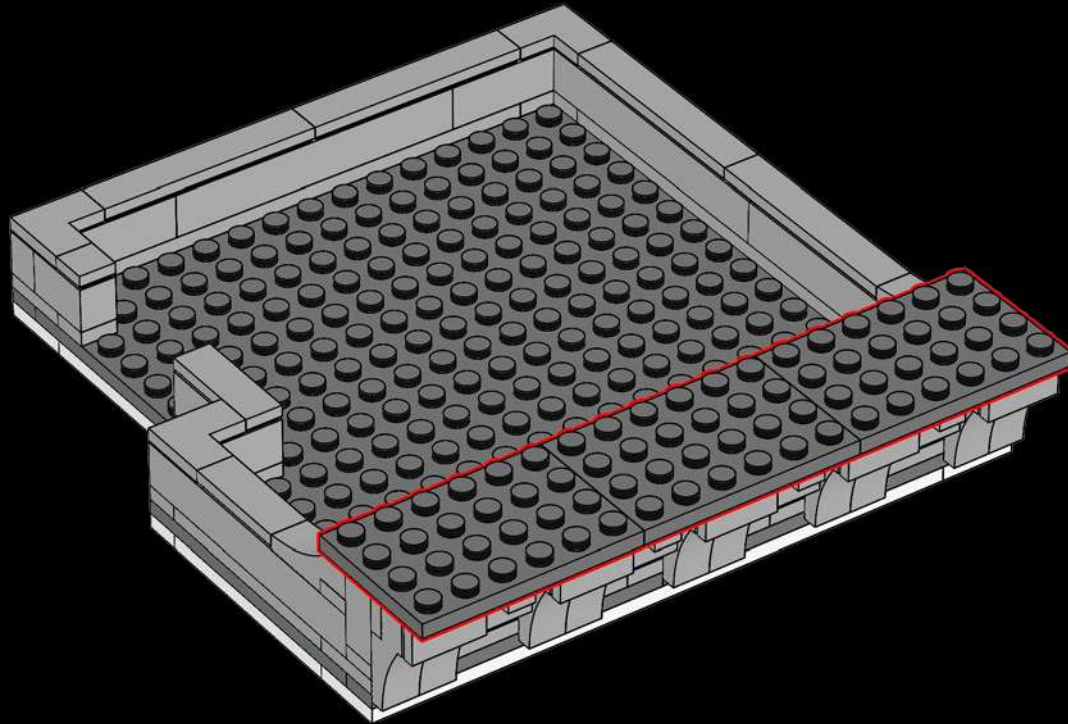

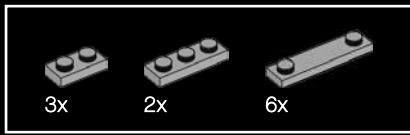

408

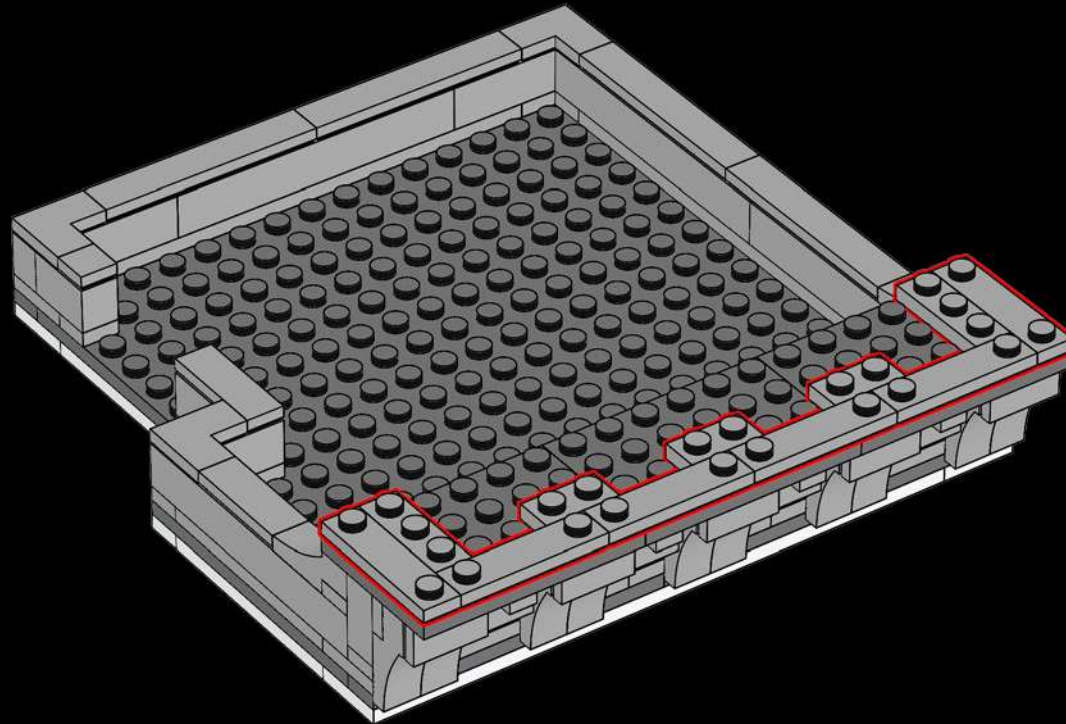

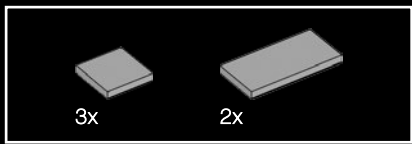

409

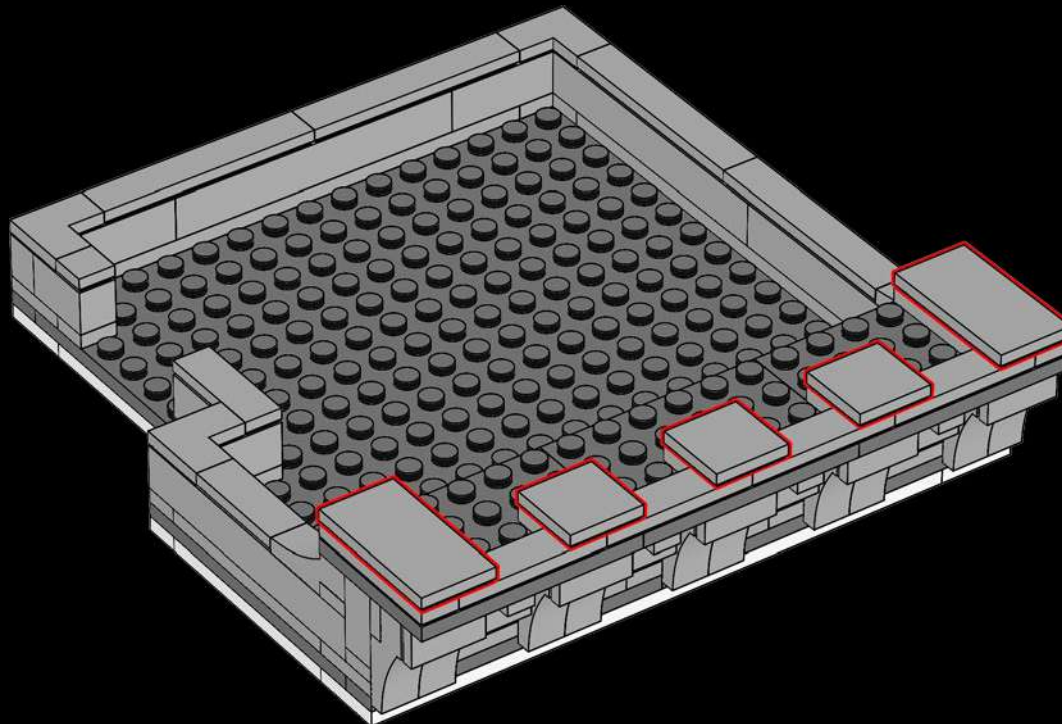

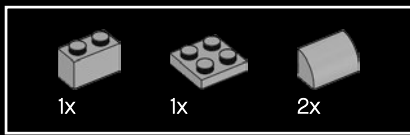

410

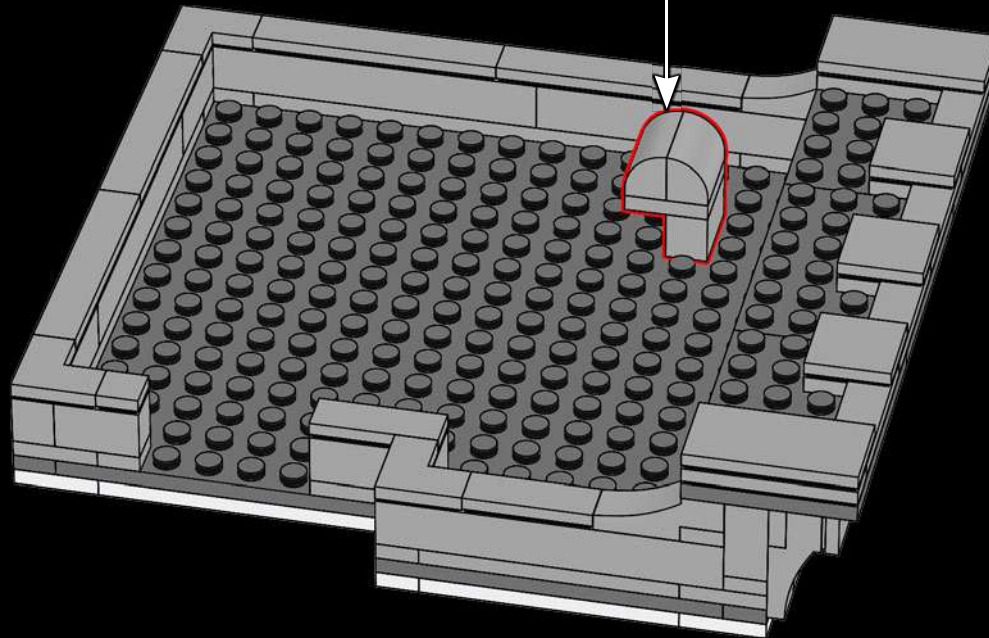
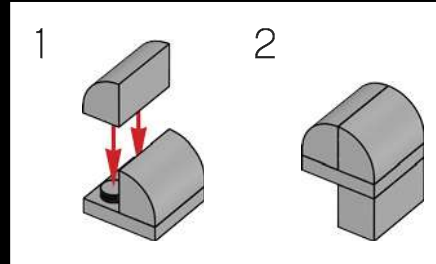

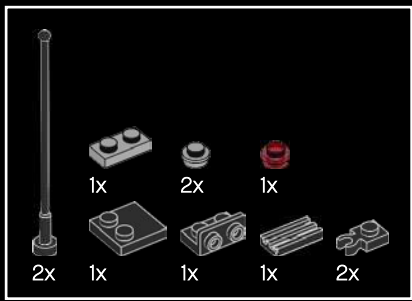

411

1

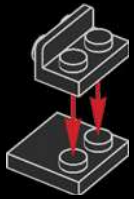

2

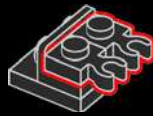

3

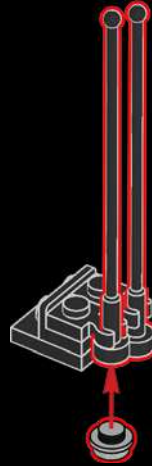

4

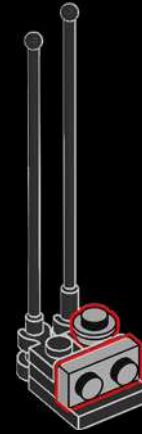

5

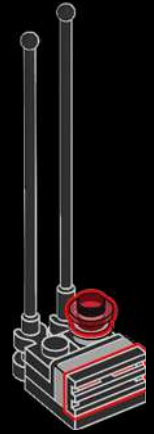

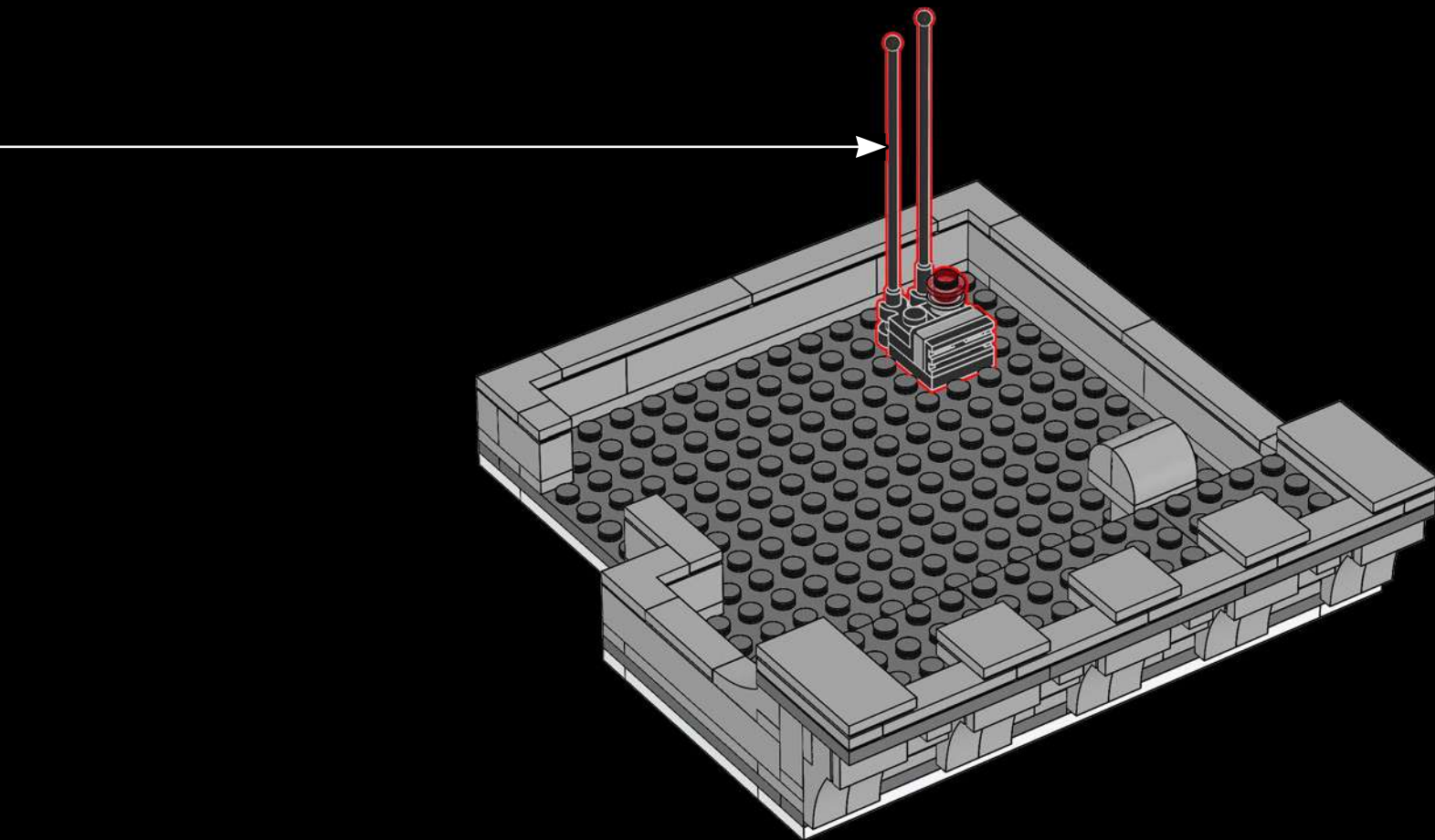

412

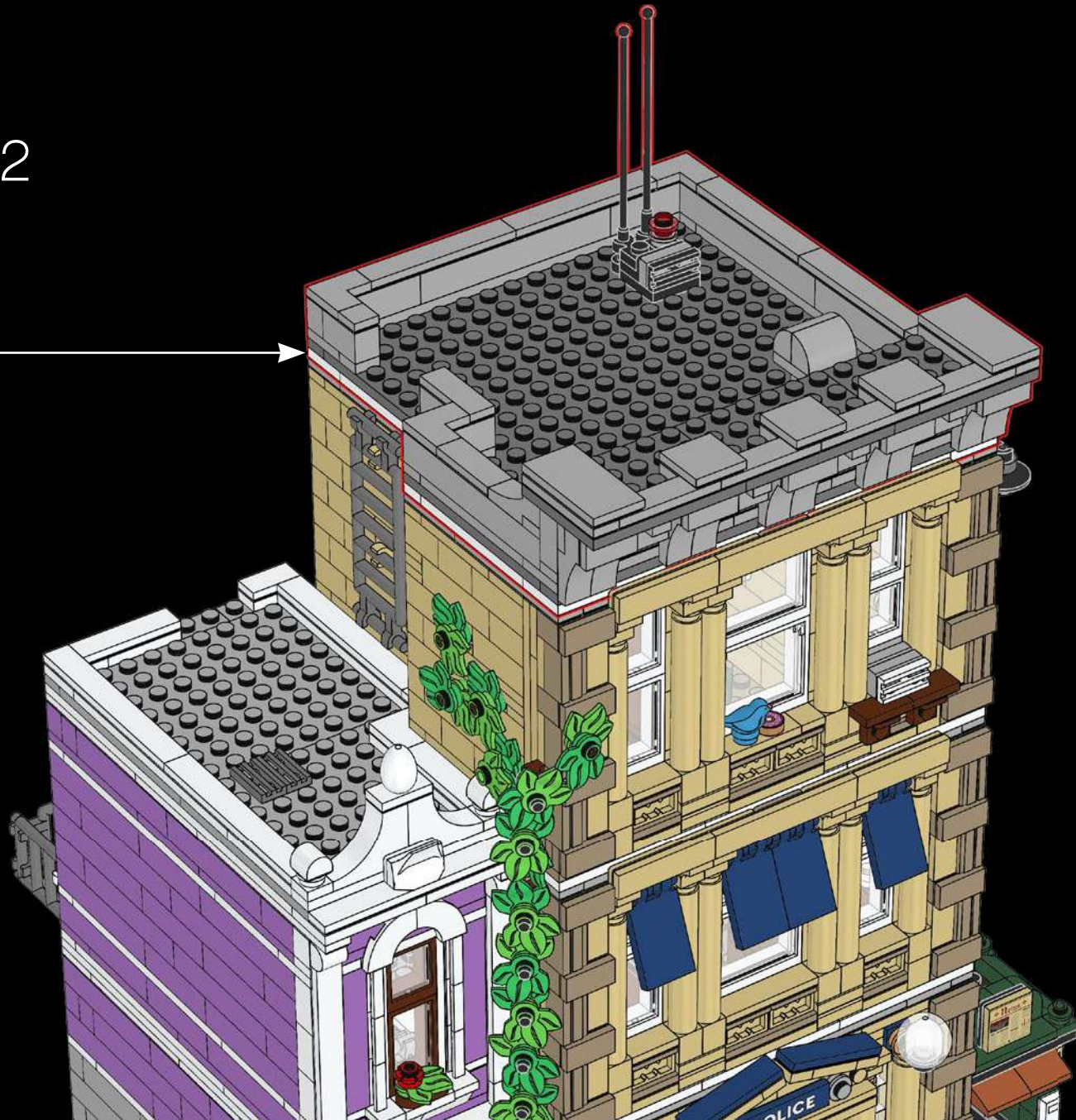



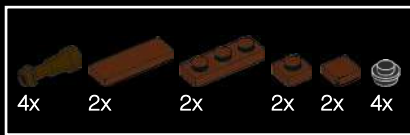

413

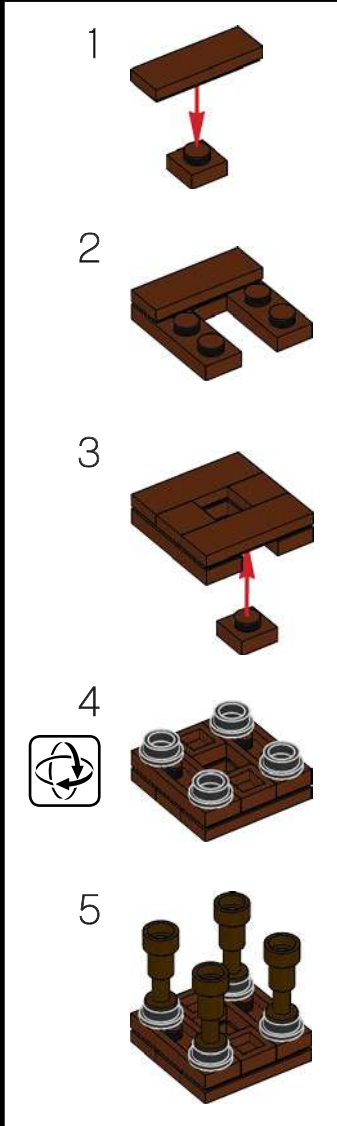

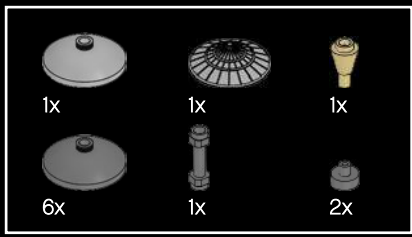

414

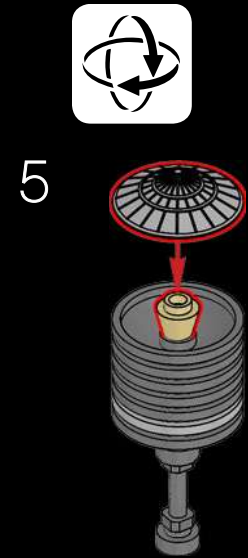
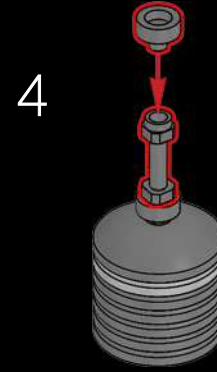
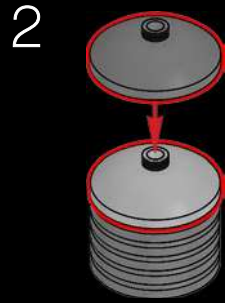
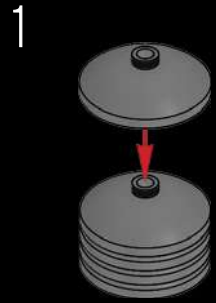

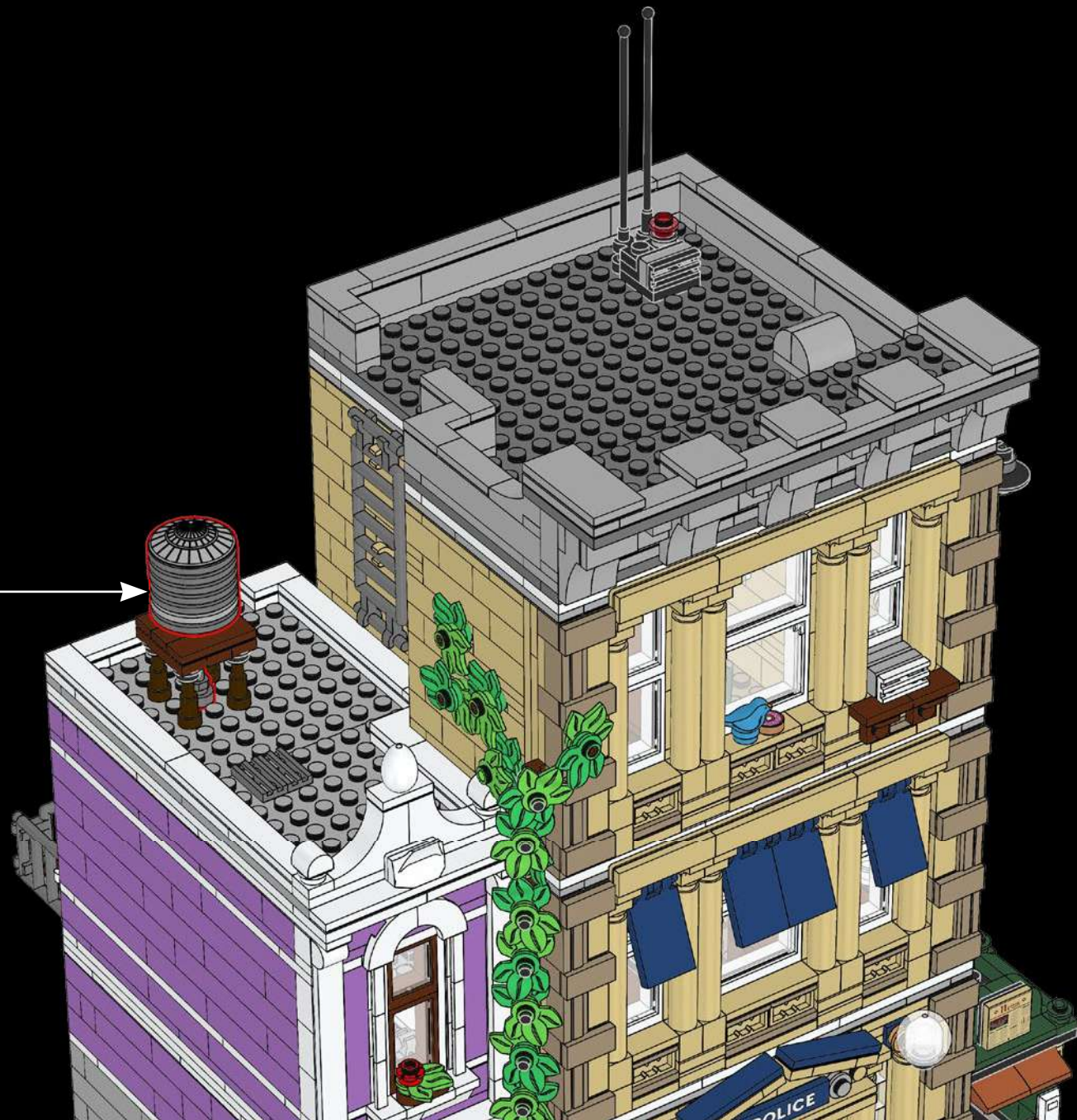

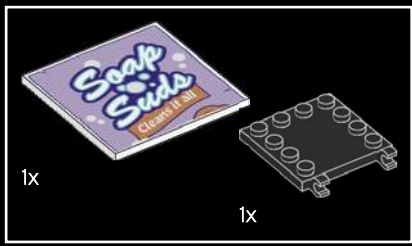

415

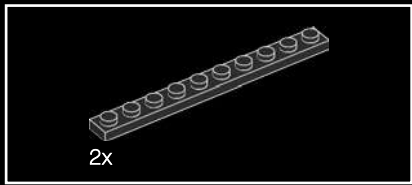
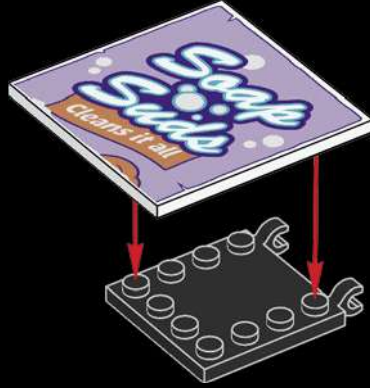

416

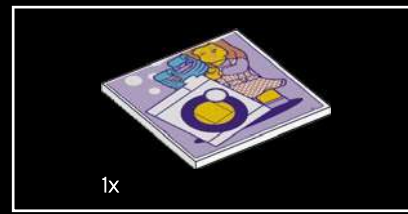
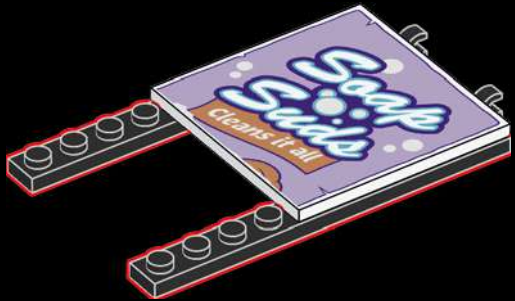

417

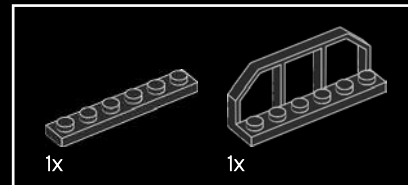

418

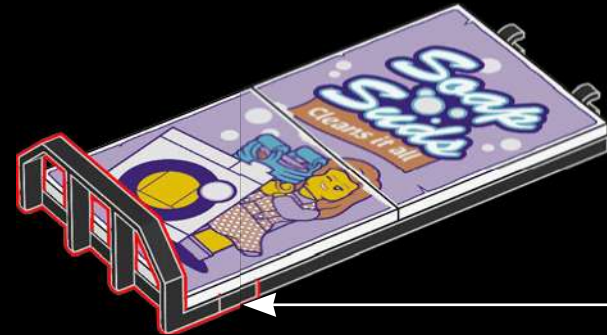
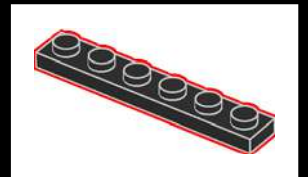



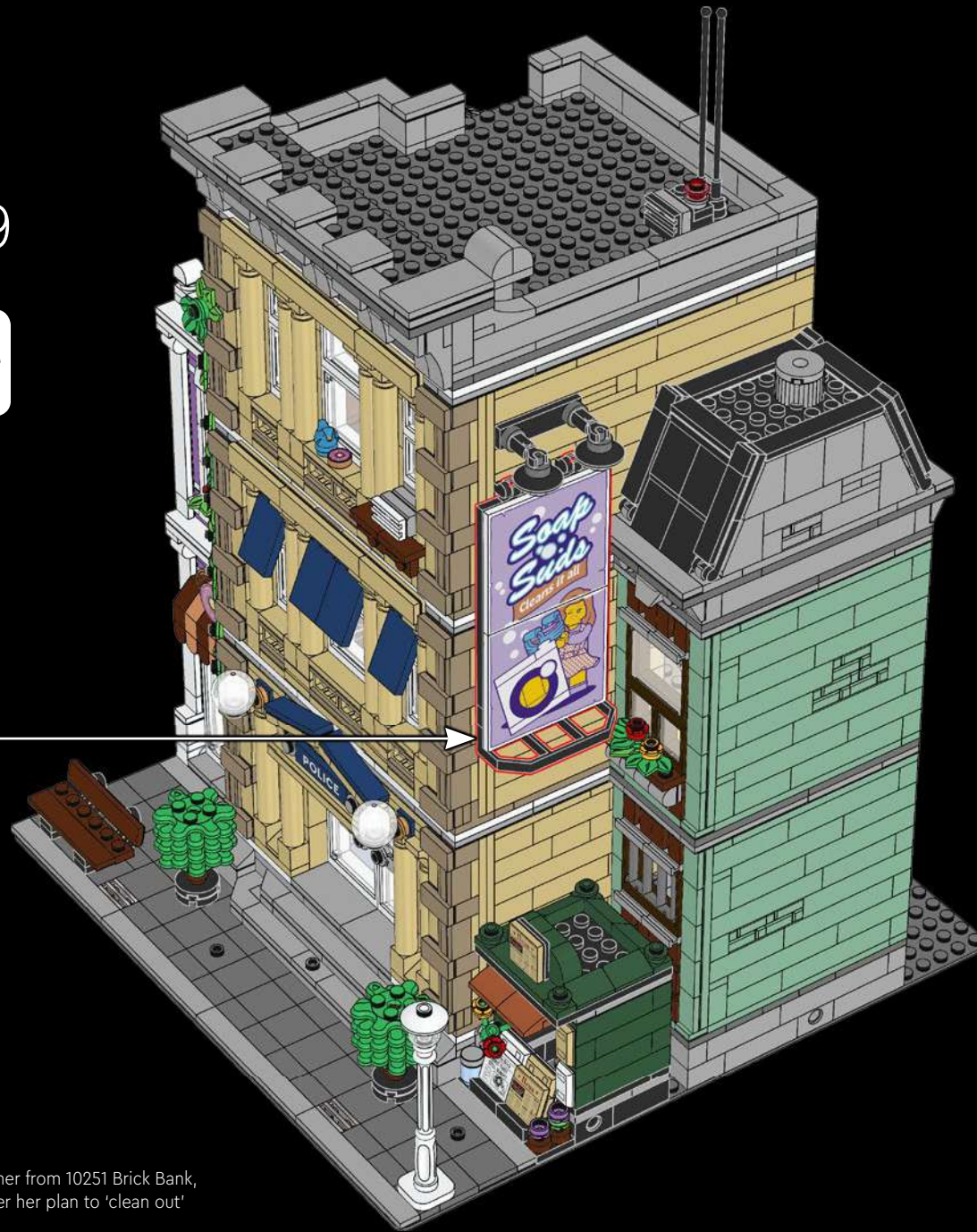



















































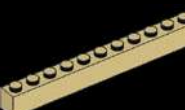



































































419



The billboard shows the clever laundrette owner from 10251 Brick Bank, who is convinced the police will never discover her plan to 'clean out' the vault.

- 1x 306201
- 3x 4518400
- 17x 6186681
- 10x 614101
- 1x 6143595
- 2x 6235083
- 11x 302401
- 10x 307001
- 2x 4504369
- 6x 6258135
- 4x 4558952
- 10x 6218841
- 1x 300501
- 1x 6210272
- 2x 6330191
- 2x 4547489
- 4x 6050914
- 1x 6052201
- 1x 474001
- 1x 9327
- 1x 6295301
- 1x 4113261
- 3x 6210076
- 1x 241201
- 4x 6051511
- 5x 4536521
- 2x 370001
- 10x 302301
- 1x 300401
- 1x 6176240
- 12x 306901
- 5x 4521210
- 3x 6117940
- 3x 6070698
- 1x 6097637
- 1x 6014274
- 1x 6011794
- 2x 6250019
- 6x 4249563
- 1x 303401
- 1x 6323426
- 1x 6323425
- 2x 611101
- 2x 6172674
- 5x 242001
- 7x 6058329
- 2x 4612342
- 1x 362201
- 2x 6110019
- 1x 4521943
- 1x 6248223
- 14x 447701
- 3x 346001
- 7x 4119227
- 3x 243101
- 5x 371001
- 9x 4530590
- 3x 6262945
- 1x 4560178
- 10x 302001
- 8x 366601
- 6x 663601
- 2x 379501
- 11x 416201
- 10x 303201
- 2x 6323424
- 3x 6218822
- 6x 6126046
- 5x 306801
- 6x 302201
- 6x 362301
- 4x 6317345
- 2x 302101
- 3x 6156667
- 4x 6249091
- 1x 6017003
- 17x 4161734
- 34x 4159553
- 2x 4579260
- 2x 4516055
- 16x 6178916
- 2x 4125253
- 33x 4113915
- 9x 6057517
- 4x 6232135
- 2x 4112980
- 1x 6177890
- 1x 6177891
- 5x 4278422
- 1x 6323422
- 1x 6323423
- 1x 4125220
- 16x 6236425
- 9x 6092587
- 2x 6313119
- 4x 6148262
- 1x 6146221
- 19x 4159279
- 15x 6024495
- 2x 6063943
- 37x 4109995
- 25x 4114026
- 2x 6271228
- 59x 4113917
- 2x 4114064
- 2x 6249809
- 7x 4550324
- 1x 4201062
- 21x 4113233
- 34x 4113916
- 14x 4124067
- 18x 4112982
- 7x 4157277
- 6x 4181134
- 6x 6288331
- 1x 4544139
- 6x 4114324
- 31x 4159774

 1x 6270070	 15x 4143409	 4x 306923	 1x 6170421	 12x 300526	 1x 6156991	 8x 4273703	 5x 307026	 6x 6284070
 1x 6174925	 5x 4166138	 2x 4121936	 2x 6265148	 2x 6234695	 2x 6192309	 4x 242026	 1x 6254045	 4x 6335388
 2x 6135300	 2x 6135300	 2x 303923	 1x 4221775	 1x 4587301	 2x 370026	 4x 235726	 1x 6300355	 5x 6196548
 18x 6221467	 1x 4509897	 1x 302023	 4x 4538456	 4x 6210270	 4x 302326	 2x 6052126	 5x 6138726	 2x 6336989
 2x 6173057	 7x 4249019	 2x 306224	 4x 6315897	 2x 6330189	 1x 6020193	 4x 4515368	 2x 614987	 2x 6092585
 10x 4114077	 1x 6075179	 1x 6283875	 4x 6186675	 6x 6157554	 1x 6000650	 2x 362226	 1x 6174917	 4x 6114987
 33x 4124455	 3x 6328178	 1x 6218310	 4x 6315897	 1x 6323421	 2x 6250020	 4x 362326	 2x 395726	 1x 6146220
 33x 4162465	 3x 6328177	 1x 6270417	 2x 6056234	 4x 4548180	 16x 6214807	 2x 4558170	 1x 302026	 1x 6328408
 2x 6131896	 3x 6206148	 1x 6223923	 7x 6186675	 2x 6323420	 2x 6151289	 2x 6116604	 2x 366626	 19x 6229130
 8x 4121921	 3x 6206148	 1x 6289787	 6x 6168646	 6x 403226	 5x 302226	 4x 6162892	 2x 663626	 2x 403228
 7x 6328182	 1x 4544143	 1x 6270480	 8x 614126	 2x 474026	 3x 6192346	 7x 243126	 2x 663626	 1x 6269971
 4x 6211966	 1x 4599453	 1x 6271140	 11x 6278152	 2x 6279875	 5x 6195325	 1x 301026	 1x 6310190	 12x 6328186
 4x 4118790	 1x 243121	 2x 6329646	 2x 6170545	 5x 6195325	 1x 306826	 1x 4565323	 1x 6271649	 2x 6206150
 2x 6213676	 2x 300121	 1x 6293876	 6x 6273589	 5x 306926	 1x 4565323	 2x 395826	 1x 303226	 2x 6235080

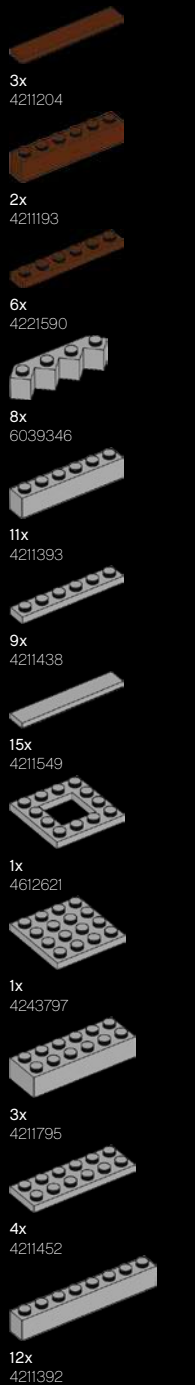
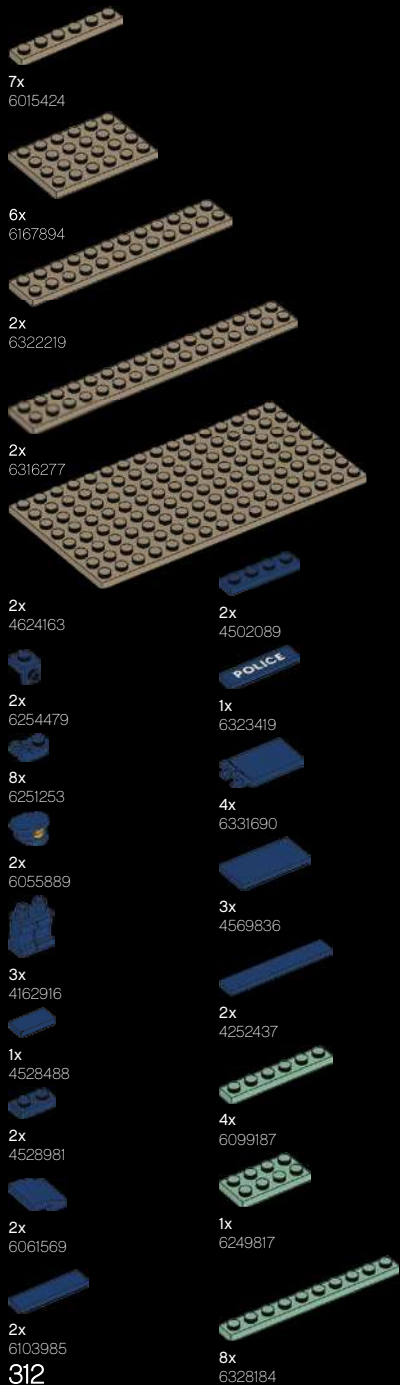



2x 6313114	18x 4211389	1x 4641048	7x 4211349	6x 4211396	1x 6335378	1x 4210934	27x 4211055	1x 6296951
4x 6186657	3x 6225242	4x 6131700	2x 4654577	2x 6171894	1x 6337268	1x 4210872	2x 4211054	3x 6284596
16x 4211388	1x 6186013	5x 4244627	1x 6187170	2x 6315580	3x 4211425	1x 4210869	2x 6177079	6x 6271752
35x 4211398	1x 4211508	2x 6319336	1x 6070564	2x 6315580	10x 4211481	2x 6092572	2x 4210635	9x 6344022
15x 4211414	1x 6281998	6x 6126082	1x 6070564	1x 4211421	1x 4211481	2x 4210631	1x 4210702	2x 4210719
1x 4211440	9x 6248890	3x 4211397	1x 6251044	23x 4211394	1x 4251149	5x 4211063	6x 4210865	3x 4211056
4x 6326078	2x 6227897	5x 4211413	10x 4211428	8x 4211445	1x 4211521	17x 4211052	1x 4211333	9x 4211002
1x 6254402	1x 4211735	1x 6102357	11x 4211429	20x 4211356	1x 4211462	2x 4211066	4x 4210998	1x 4211008
2x 4211564	2x 4568637	2x 6212077	12x 6329117	3x 4211636	2x 4514846	1x 4211335	5x 4521886	1x 4211008
2x 6227184	2x 6179186	5x 4211353	4x 4558169	21x 6257593	1x 4211402	1x 6250018	2x 4211043	6x 4211115
9x 6066097	1x 4650645	18x 6065824	1x 6248917	2x 6315579	1x 4211402	1x 4543086	4x 4211001	1x 4210997
5x 6000066	2x 6092956	5x 4211387	2x 6315579	3x 4211395	3x 4166618	5x 6310596	1x 6262942	4x 4667977
7x 6123809	1x 6125569	2x 4211436	2x 4211773	1x 6168615	2x 4210794	3x 6126083	1x 4211065	4x 4211134
5x 6004990	1x 6248492	1x 6034676	1x 6170385	18x 4560183	1x 6133611	1x 4211094	8x 6309059	
14x 4211568	8x 4515374	4x 6177078				8x 6309059		



1x 6037634

1x 6004927

1x 6139364

- 9x 6315329
- 5x 6287854
- 9x 6167641
- 4x 6296061
- 1x 6257433

- 1x 6287960
- 2x 6335307
- 2x 6104344
- 2x 6186007
- 2x 4535928

- 4x 6209681
- 2x 6215387
- 4x 6060795
- 1x 6096589
- 1x 6195266
- 2x 6336971
- 2x 6238674

- 2x 6240030
- 1x 6247785
- 1x 6208450
- 2x 6238677
- 3x 6274739
- 1x 4529672
- 4x 6328188
- 4x 4538950
- 4x 6252667
- 5x 6328181
- 1x 6226792
- 2x 4518687
- 2x 6337282

- 2x 6209684
- 8x 4619521
- 1x 6097301
- 8x 6125776
- 11x 4651903
- 3x 6347299
- 1x 6152645
- 21x 4623598
- 15x 4619512
- 8x 6173813
- 3x 4619524
- 14x 6107188
- 2x 6265058
- 26x 6251908
- 9x 4649745

- 1x 6055172
- 2x 4549436
- 42x 4496699
- 42x 4528604
- 6x 6310835
- 11x 4521914
- 8x 6330148
- 20x 6250168
- 6x 6328183
- 2x 6126075
- 5x 4507045
- 3x 4550168
- 1x 6132768
- 2x 6164288
- 2x 4267874

- 1x 6244882
- 1x 6251292
- 15x 6142505
- 7x 6057880
- 1x 6062089
- 1x 6248957
- 3x 6124349
- 1x 6240515
- 1x 6251285
- 3x 6247362
- 12x 6253734

- 4x 6285587
- 2x 6247798
- 1x 6274738
- 6x 6168665
- 14x 6220959
- 10x 6254552
- 8x 6252258
- 1x 6238856
- 2x 6266626
- 1x 6163901
- 1x 6286876
- 1x 6240204
- 1x 6251294

**Customer Service**  
**Kundenservice**  
**Service Consommateurs**  
**Servicio Al Consumidor**

LEGO.com/service or dial

00800 5346 5555 :

1-800-422-5346 :



# FEEDBACK AND WIN



## FEEDBACK AND WIN

Your feedback will help shape the future development of this product series.

Please visit:

## FEEDBACK UND GEWINNEN

Dein Feedback trägt zur Weiterentwicklung dieser Produktreihe bei.

Geh auf:

## COMMENTEZ ET GAGNEZ

Vos commentaires nous aideront à concevoir les futurs produits de cette gamme.

Rendez-vous sur :

## COMENTA Y GANA

Tu opinión nos ayudará a dar forma al desarrollo de esta serie de productos en el futuro.

Visita:

## 反馈有奖

您的反馈将有助于我们在今后改进本系列产品。

请访问：

[LEGO.com/productfeedback](https://www.lego.com/productfeedback)

By completing, you will automatically enter a drawing to win a LEGO® set.

Terms & Conditions apply.

Durch Ausfüllen nimmst du automatisch an der Verlosung eines LEGO® Preises teil.

Es gelten die Teilnahmebedingungen.

En envoyant vos commentaires, vous serez automatiquement inscrit(e) à un tirage au sort qui vous permettra de remporter un prix LEGO®.

Offre soumise à conditions.

Al contestar, participarás automáticamente en el sorteo y podrás ganar un set LEGO®.

Sujeto a Términos y Condiciones.

完成我们的反馈调查，即可自动进入抽奖环节，赢取乐高®套装。

适用《条款和条件》。

