

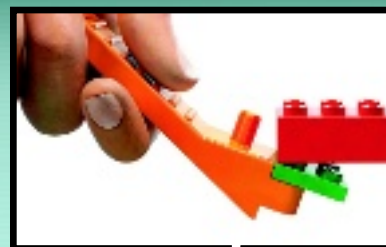

ULTRA AGENTS

70170





EN IMPORTANT: Never modify the elements or use other projectiles than provided with this toy.
 DE WICHTIG: Die Elemente dürfen nicht verändert werden. Es dürfen ausschließlich die mit dem Spielzeug mitgelieferten Geschosse verwendet werden.
 FR IMPORTANT : Ne jamais modifier les éléments ni utiliser d'autres projectiles que ceux fournis avec ce jouet.
 IT IMPORTANTE: non modificare gli elementi o utilizzare proiettili non forniti con questo prodotto.
 NL BELANGRIJK! Verander niets aan de elementen en gebruik geen andere projectielen dan de bij het speelgoed geleverde.
 ES IMPORTANTE: No modifique los elementos ni utilice otros proyectiles diferentes a los suministrados junto con este juguete.
 DA VIGTIG: Elementerne må ikke ændres, og der må ikke bruges andre projektiler end dem, der følger med legetøjet.
 FI TÄRKEÄÄ: Älä koskaan tee osiin muutoksia tai käyttää lelussa muita kuin sen sisältämiä ammuksia.
 SV VIKTIGT: Modifiera aldrig delarna och använd aldrig andra projektiler än de som medföljer denna leksak.
 PT IMPORTANTE: Nunca modifique os elementos nem utilize projecteis que não tenham sido fornecidos com este brinquedo.
 EL ΣΗΜΑΝΤΙΚΟ: Ποτέ μην τροποποιείτε τα στοιχεία του παιχνιδιού και μην χρησιμοποιείτε άλλα βλήματα εκτός από αυτά που συνοδεύουν αυτό το παιχνίδι.
 JA 重要： 部品を改造したり、本製品に付属の発射体以外のものを使用しないでください。
 ZH 重要提示： 切勿更改组件或使用并非由本玩具附带的弹丸。
 KO 중요함: 이들 부품을 수정하거나 이 완구와 함께 제공된 것이 아닌 발사체는 결코 사용하지 마십시오.
 RU ВАЖНО: запрещается вносить изменения в элементы или использовать другие снаряды, отличные от тех, которые поставляются с данной игрушкой.
 PL WAŻNE: Nigdy nie modyfikować elementów zabawki ani nie używać pocisków innych niż dostarczone z zabawką.
 CZ UPOZORNĚNÍ: Nikdy neupravujte součástky a nepoužívejte jiné projektily než ty, které jsou dodávány s touto hračkou.
 SK UPOZORNENIE: Nikdy neupravujte súčiastky a nepoužívajte iné projektily než tie, ktoré sú dodávané s touto hračkou.
 HU FONTOS: Az elemeket nem szabad módosítani, és a játékhöz adott lövedékek helyett sem szabad mást használni.
 UA ВАЖЛИВО: забороняється вносити зміни до елементів або використовувати інші снаряди на відміну від тих, що поставляються з цією іграшкою.



LEGO.com/brickseparator

HR VAŽNO: Nemojte nikad mijenjati elemente ili koristiti druge projekte osim onih koji su bili priloženi uz ovu igračku prilikom kupnje.
 SR VAŽNO: Nemojte da modifikujete elemente i ne koristite druge projekte osim onih koji dolaze uz ovu igračku.
 SL POMEMBNO: Nikoli ne spreminjajte elementov in uporabljajte le izstrelke, ki so bili priloženi tej igrački.
 RO IMPORTANT: Nu modificați niciodată elementele și nu utilizați alte proiectile decât cele furnizate cu această jucărie.
 BG ВАЖНО: Не видеоизменяйте елементите и не използвайте други снаряди освен приложените към тази играчка.
 LV SVARĪGĪ! Nekad nepārveidojiet rotallietas elementus, vienmēr izmantojiet tikai tās komplektā iekļautās lodītes.
 ET OLULINE: Mänguasja osi ei tohi teistega asendada, kasutada võib ainult kaasasolevat heitkeha.
 LT DĖMESIO! Niekuomet nekeisikite elementų ir naudokite tik tuos šovinius, kurie yra pridėti prie šio žaislo.
 TR ÖNEMLİ: Hiçbir zaman parçalarda değışiklik yapmayın veya bu oyuncakla sağlananlar dışında mermiler kullanmayın.

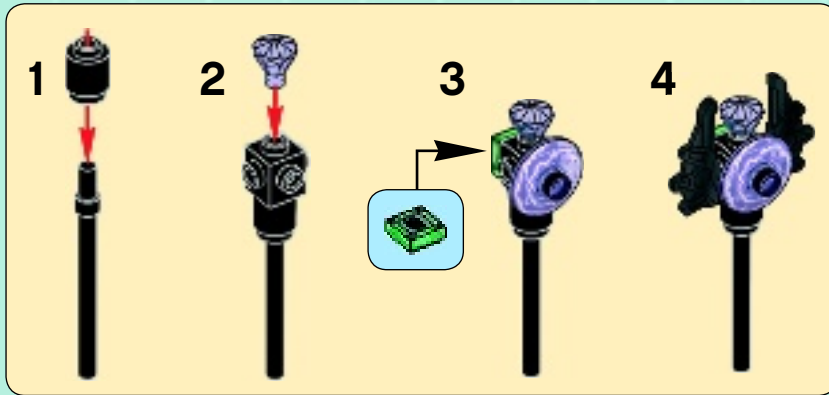
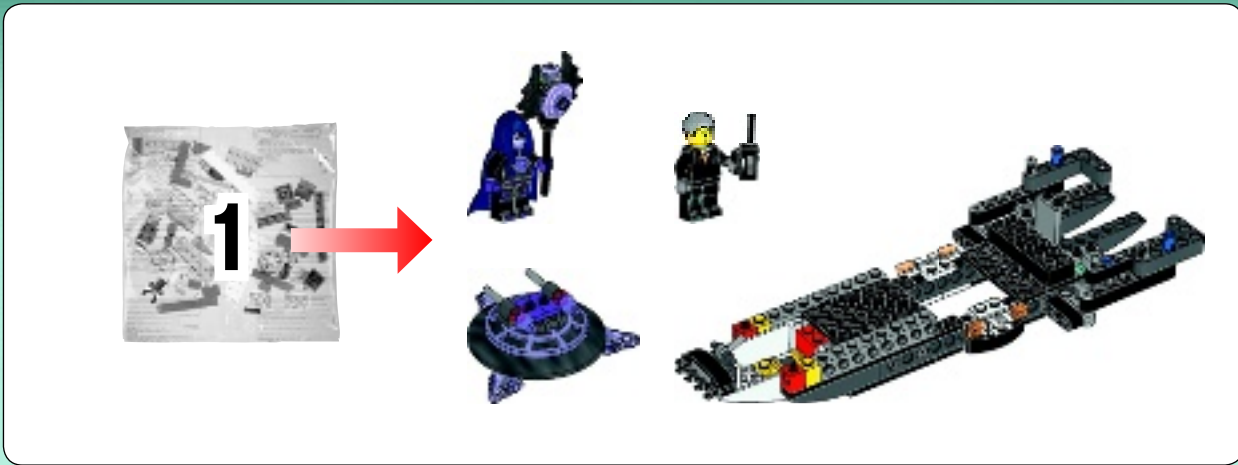



1

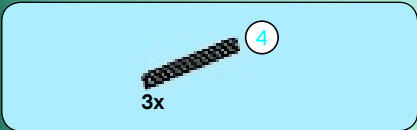

2

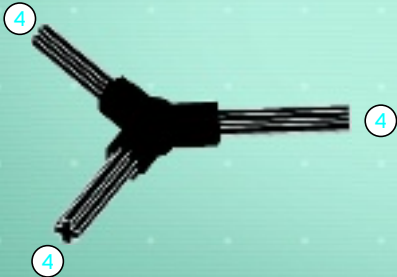

3

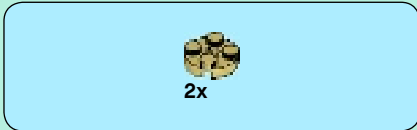
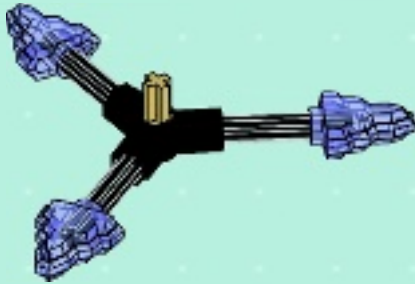

4

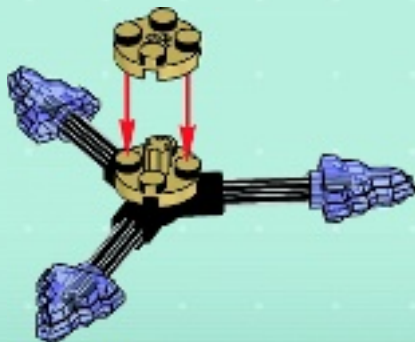

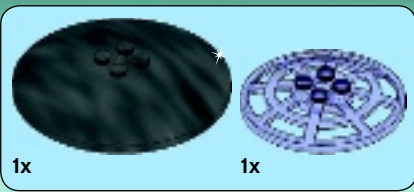

5

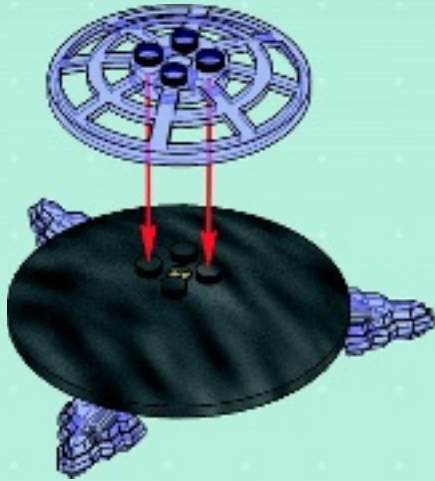

6



7



8





2x



2x



2x

9

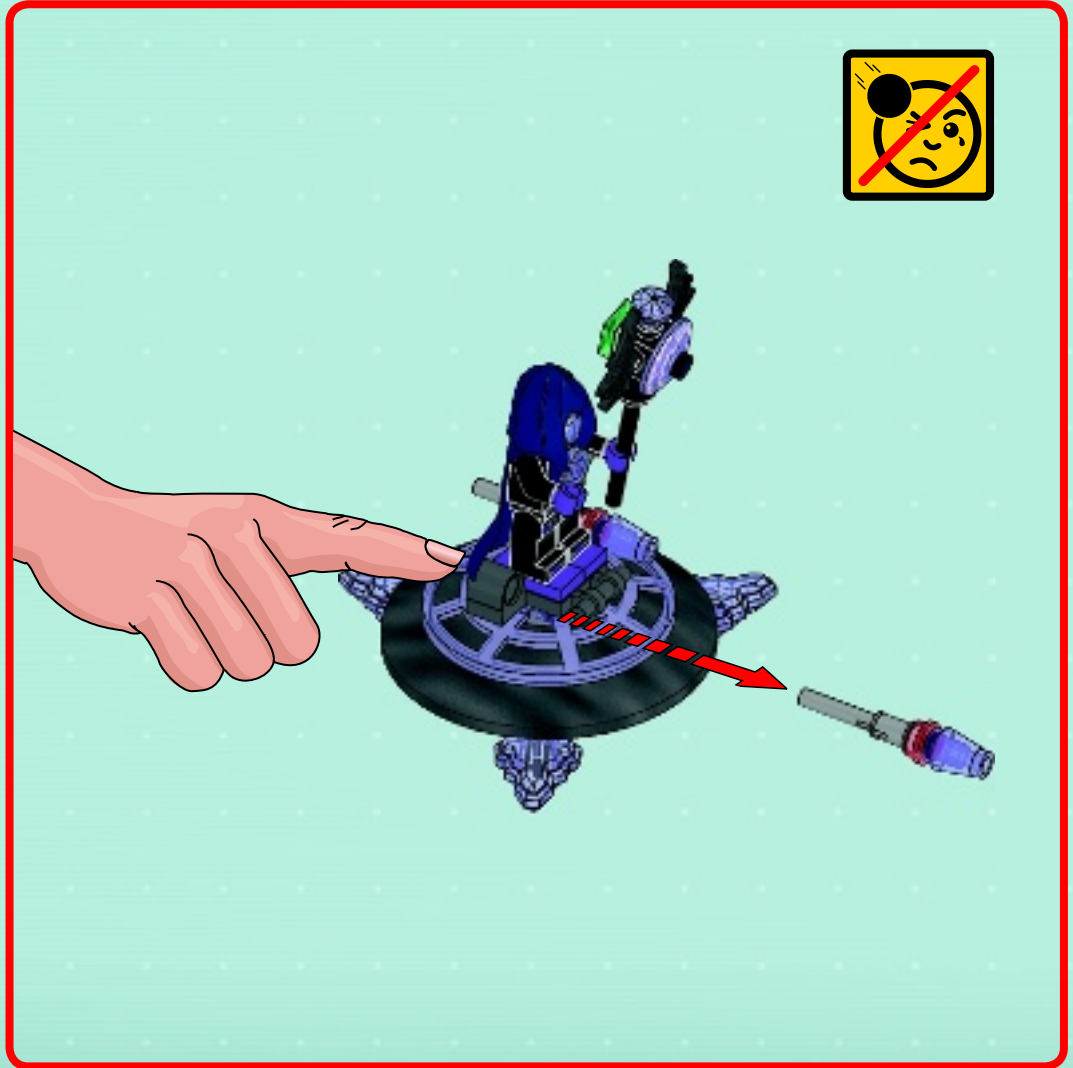
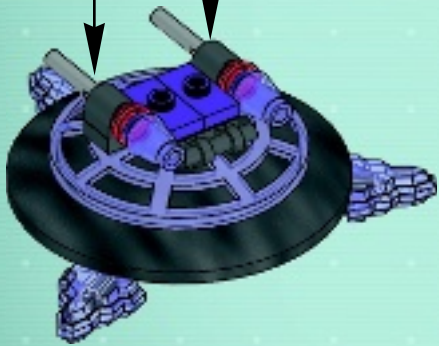
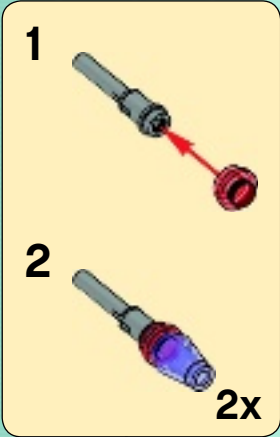

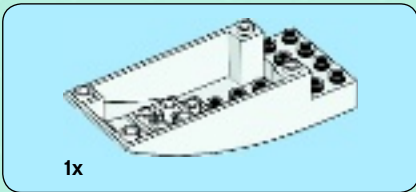

1

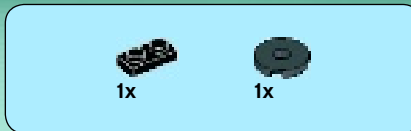
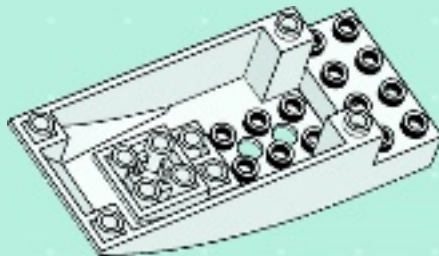

2

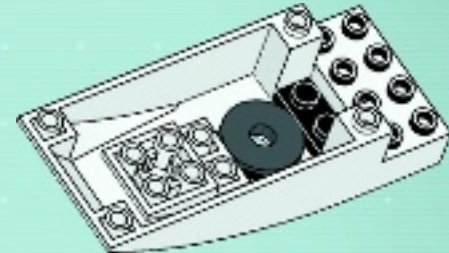

3

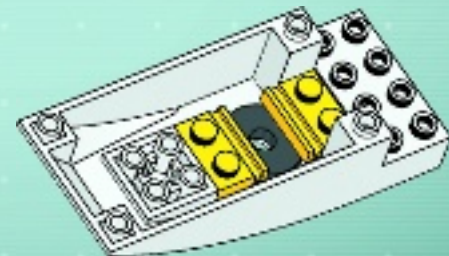

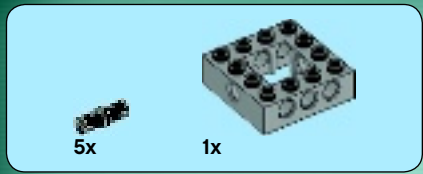

4

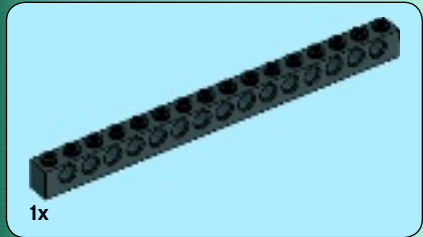
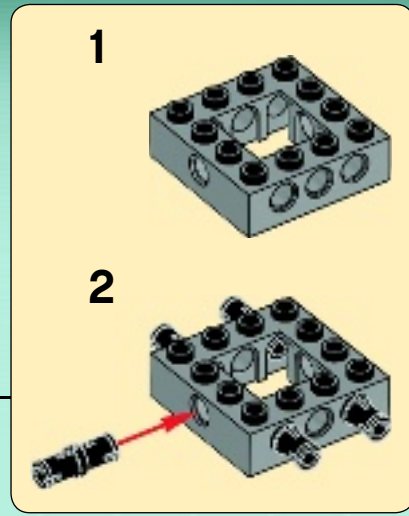
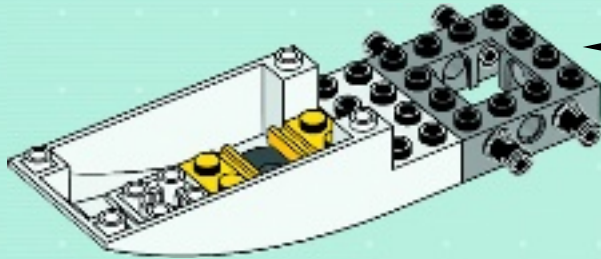

5

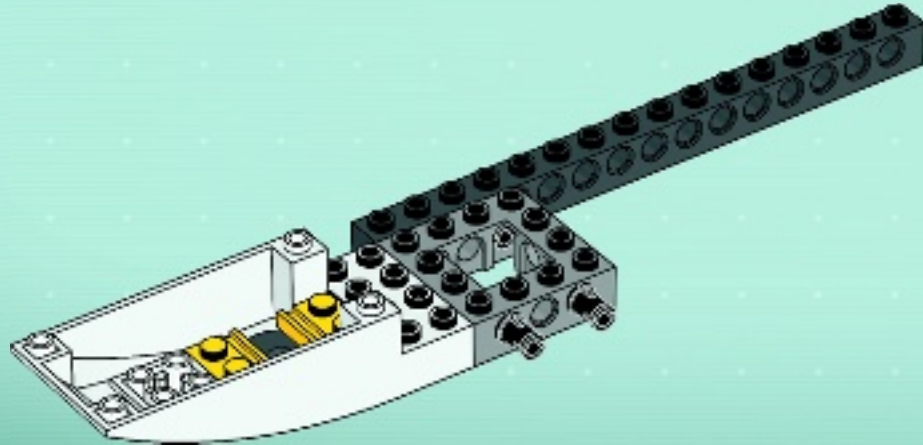

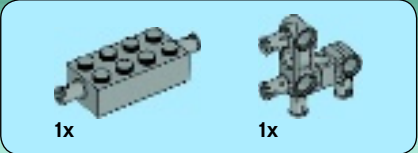

6

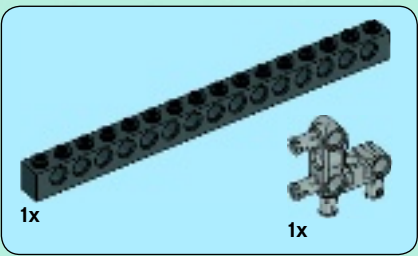
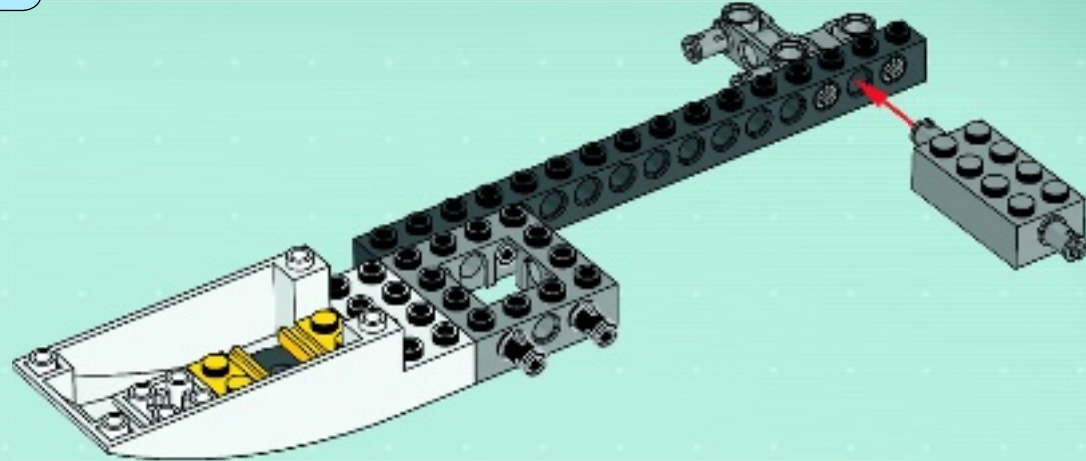

7

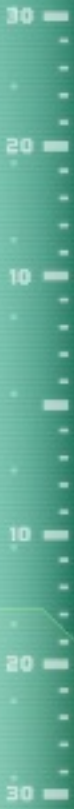
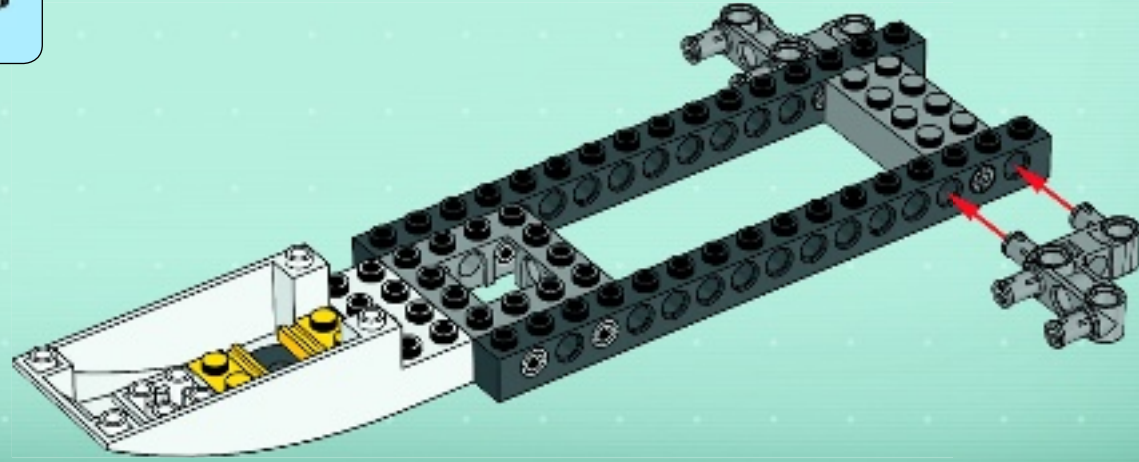



8

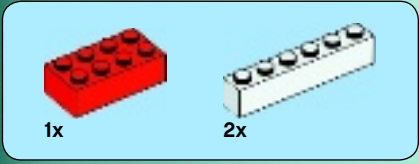
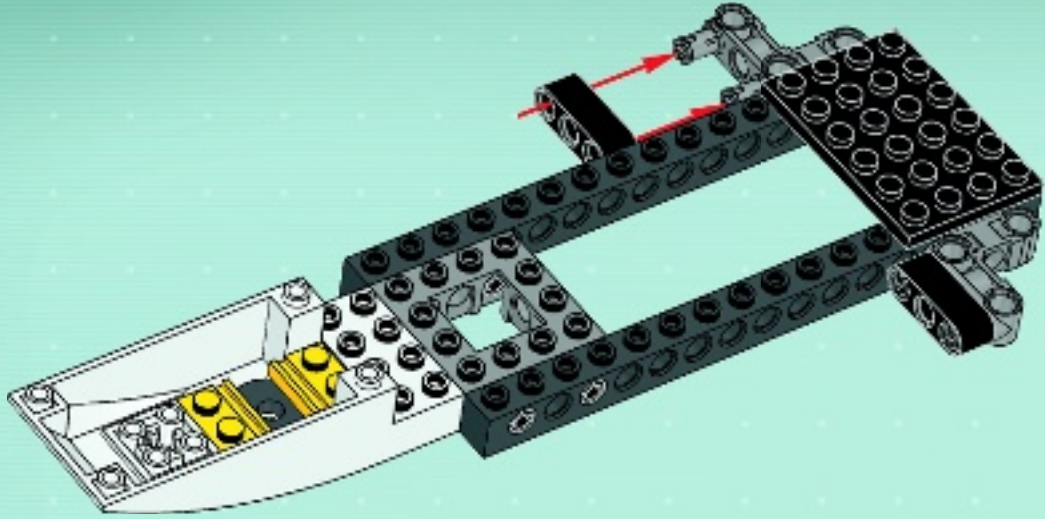

9

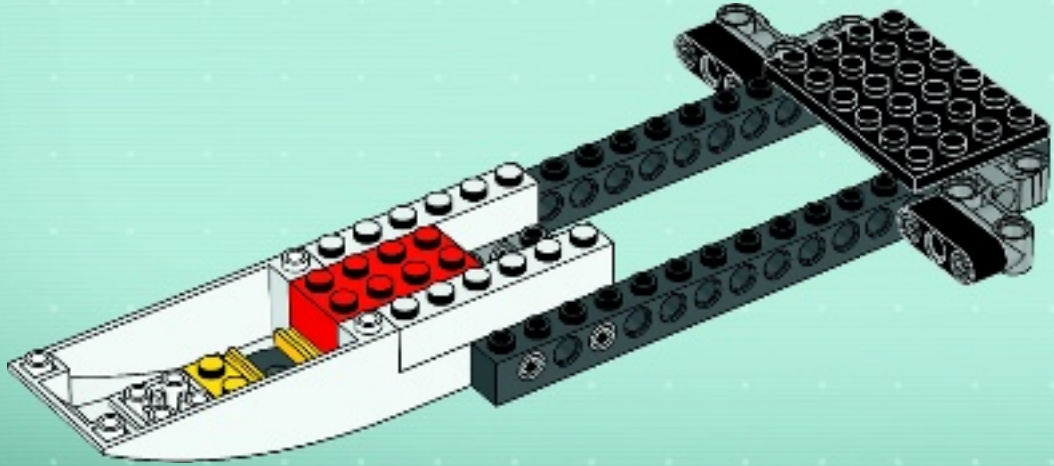



10

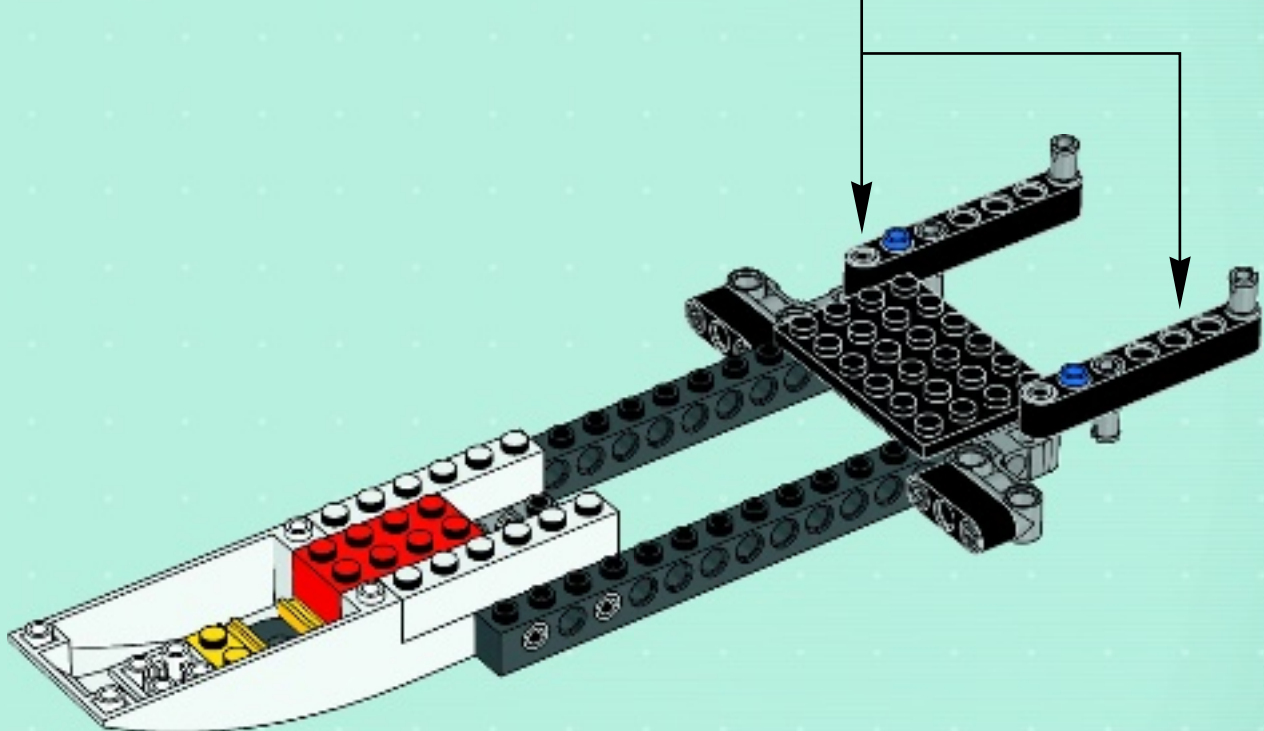
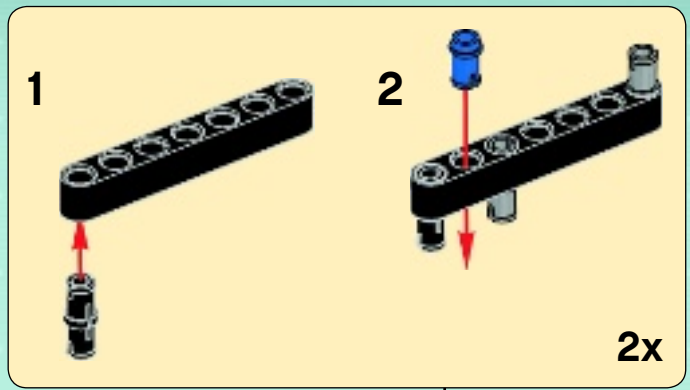

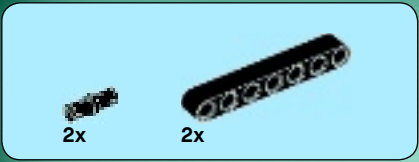

11

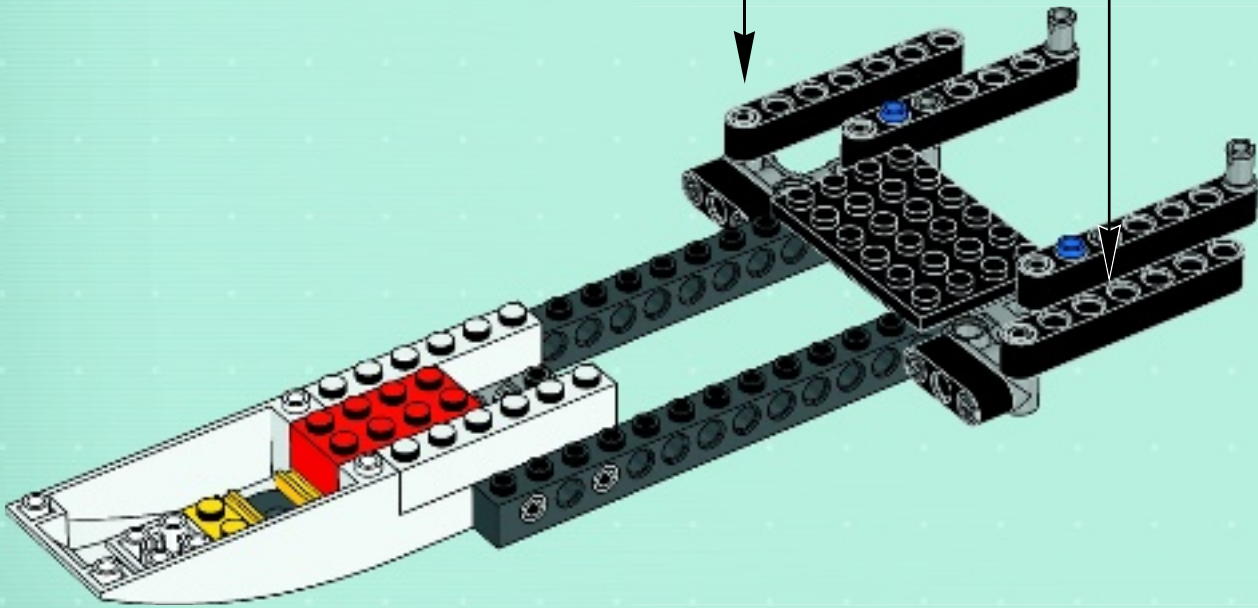
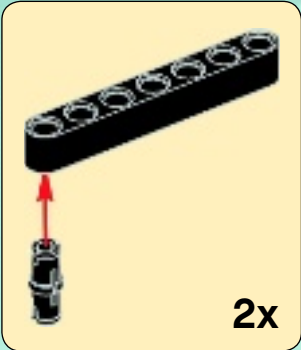

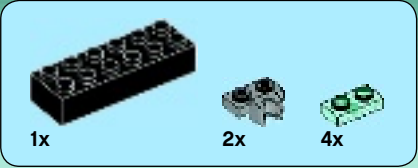

12

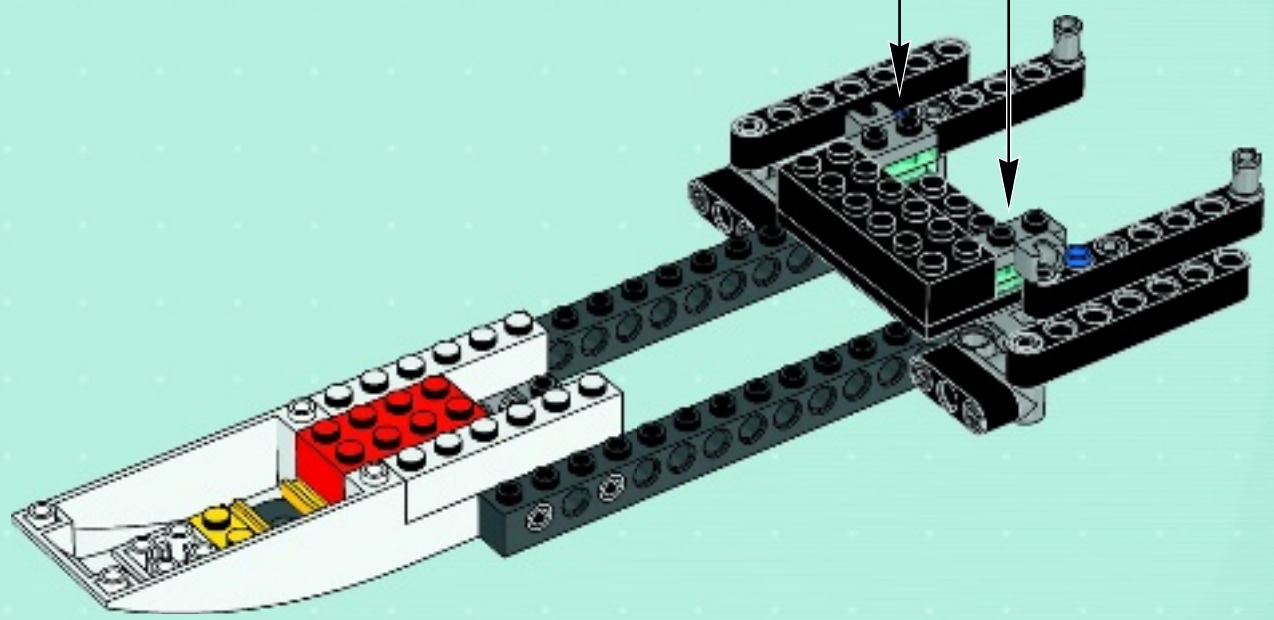
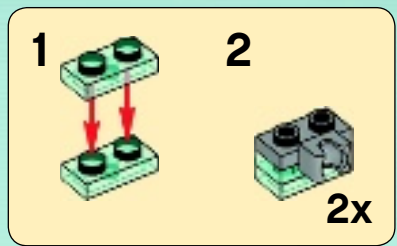

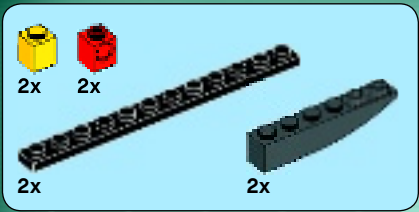

13

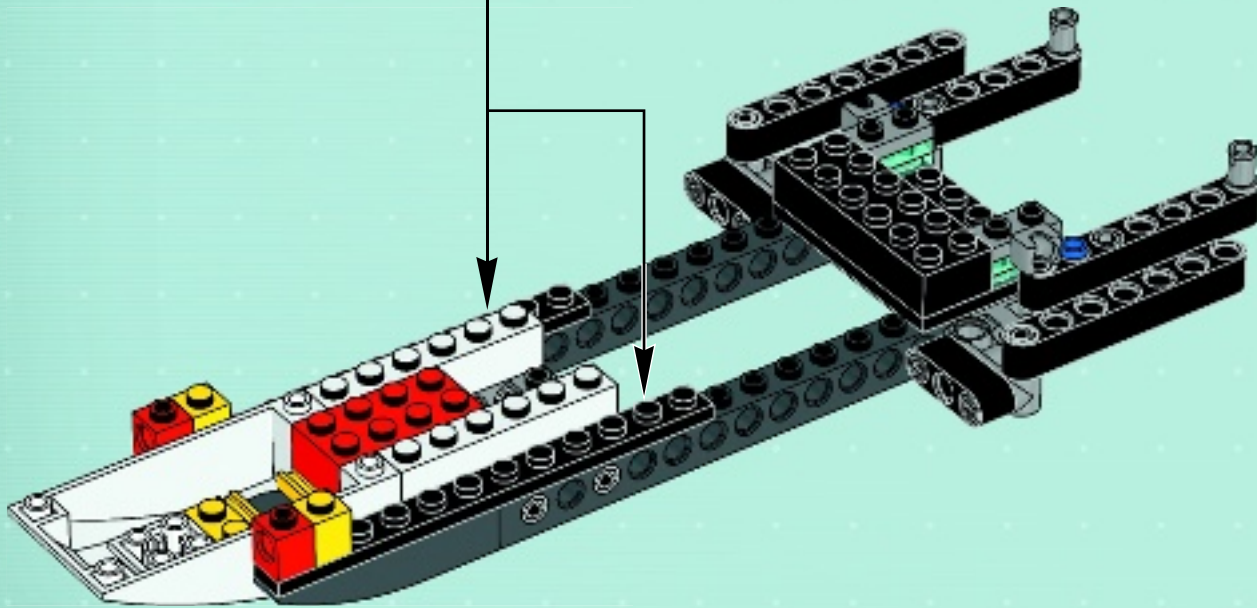
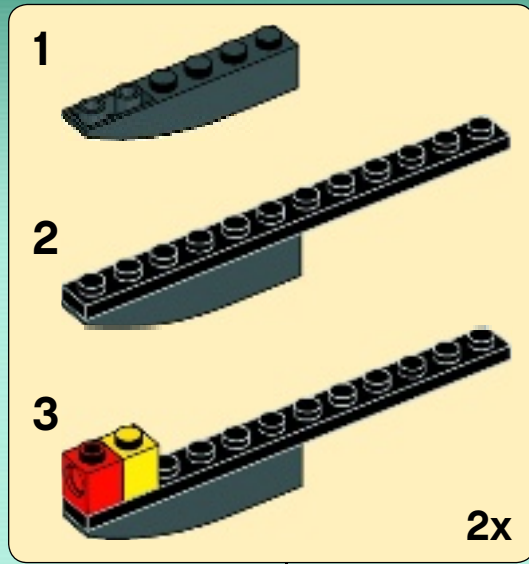

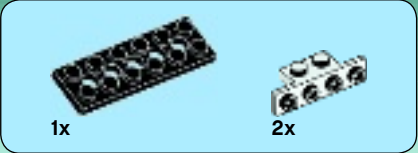

14

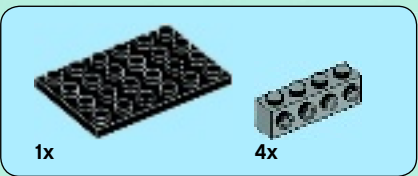
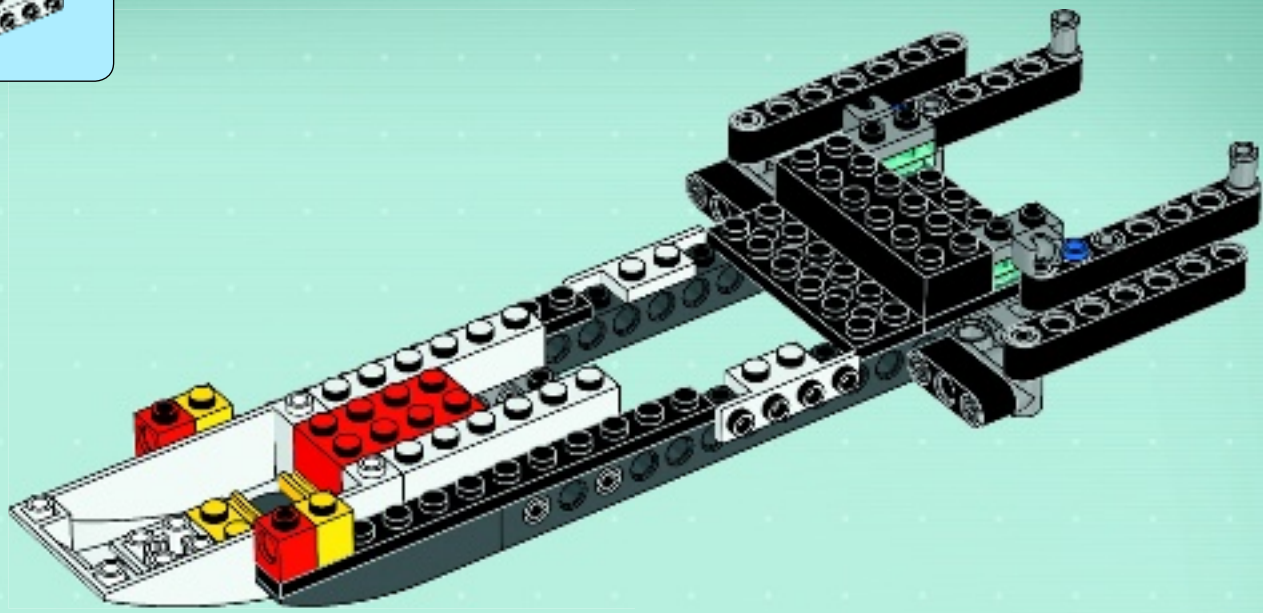

15

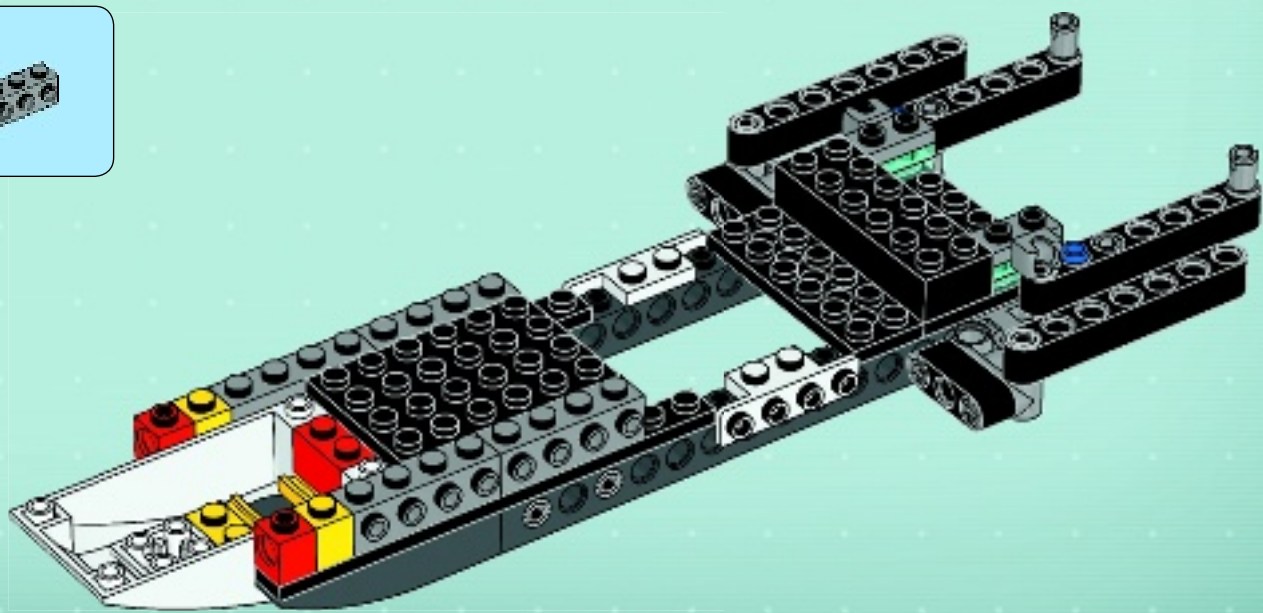

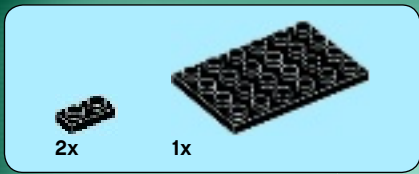

16

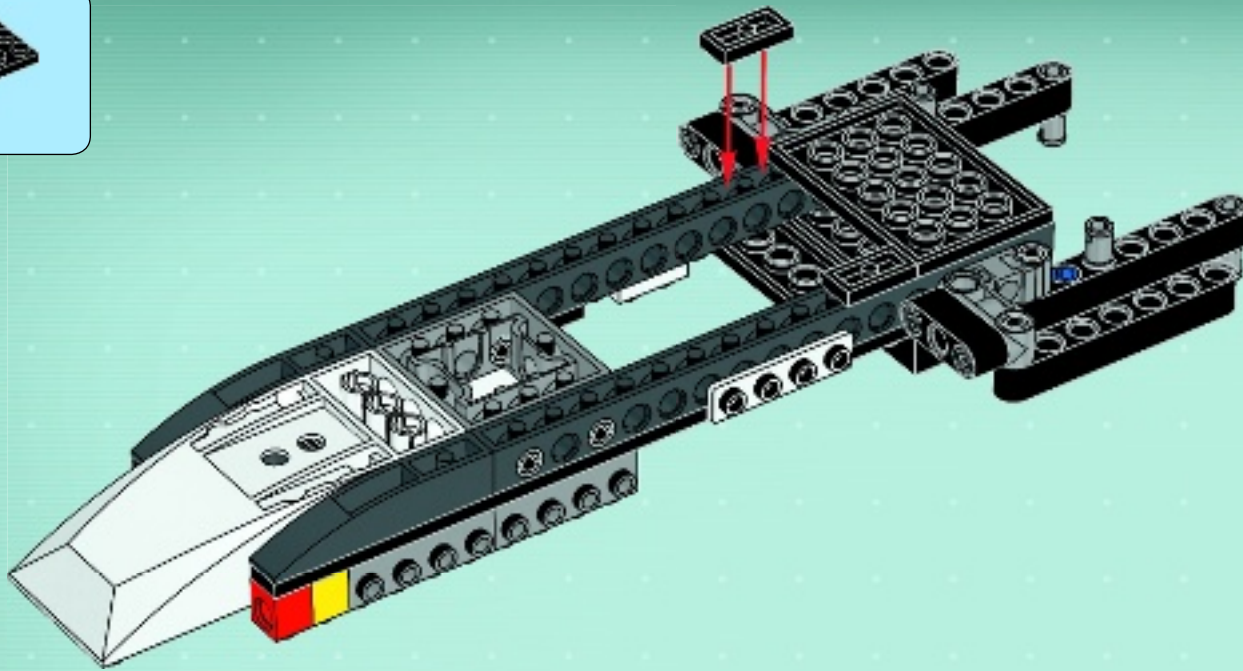

17

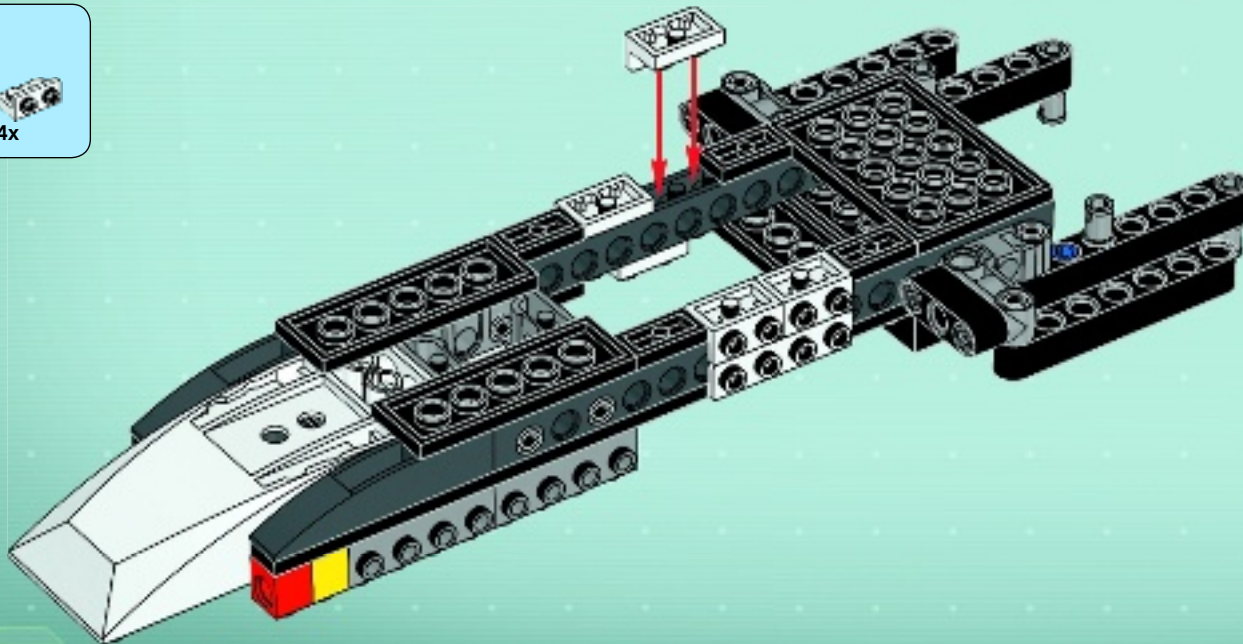

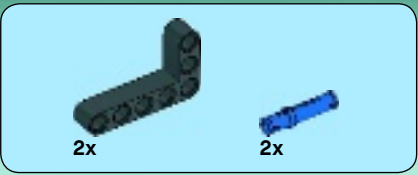

18

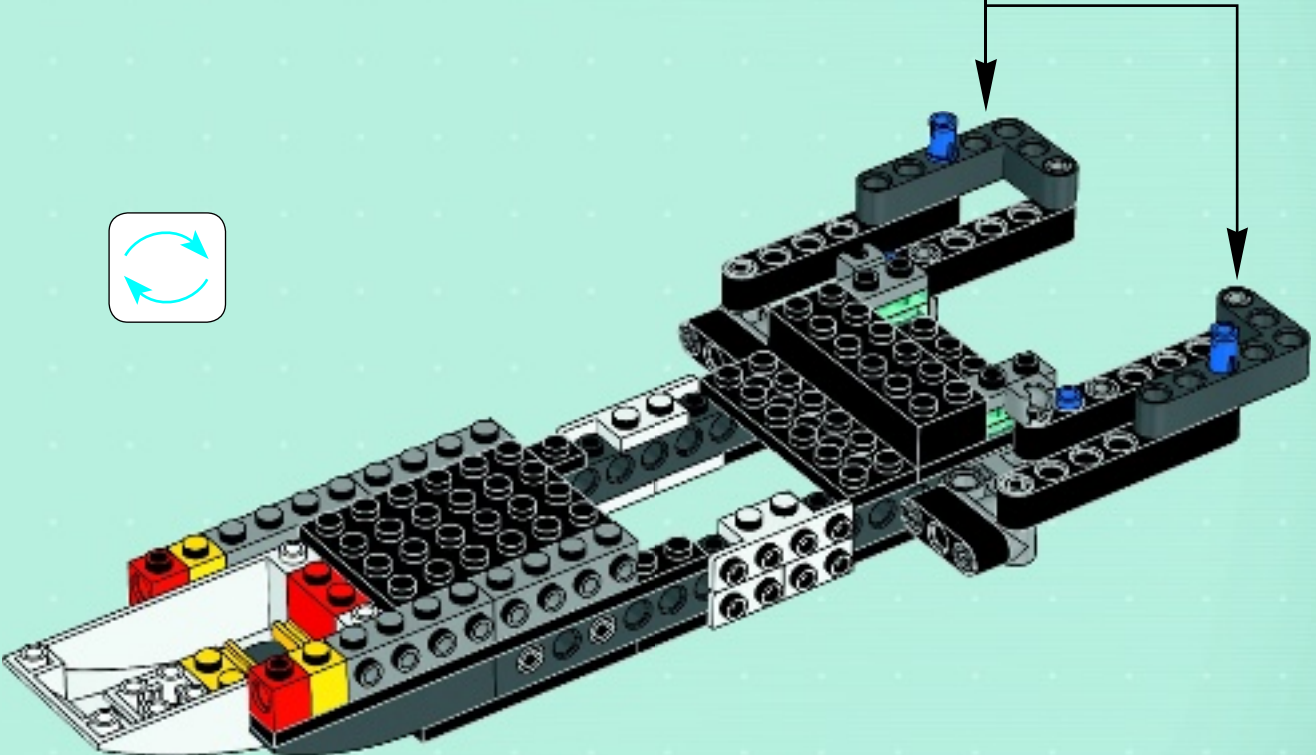
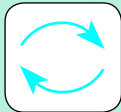
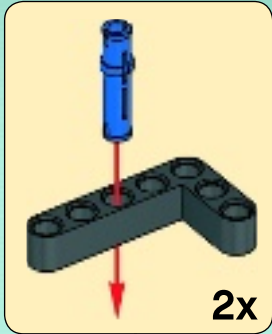

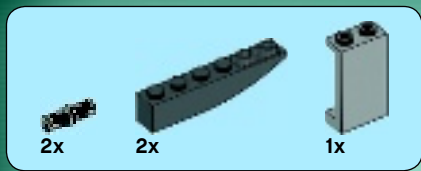

19

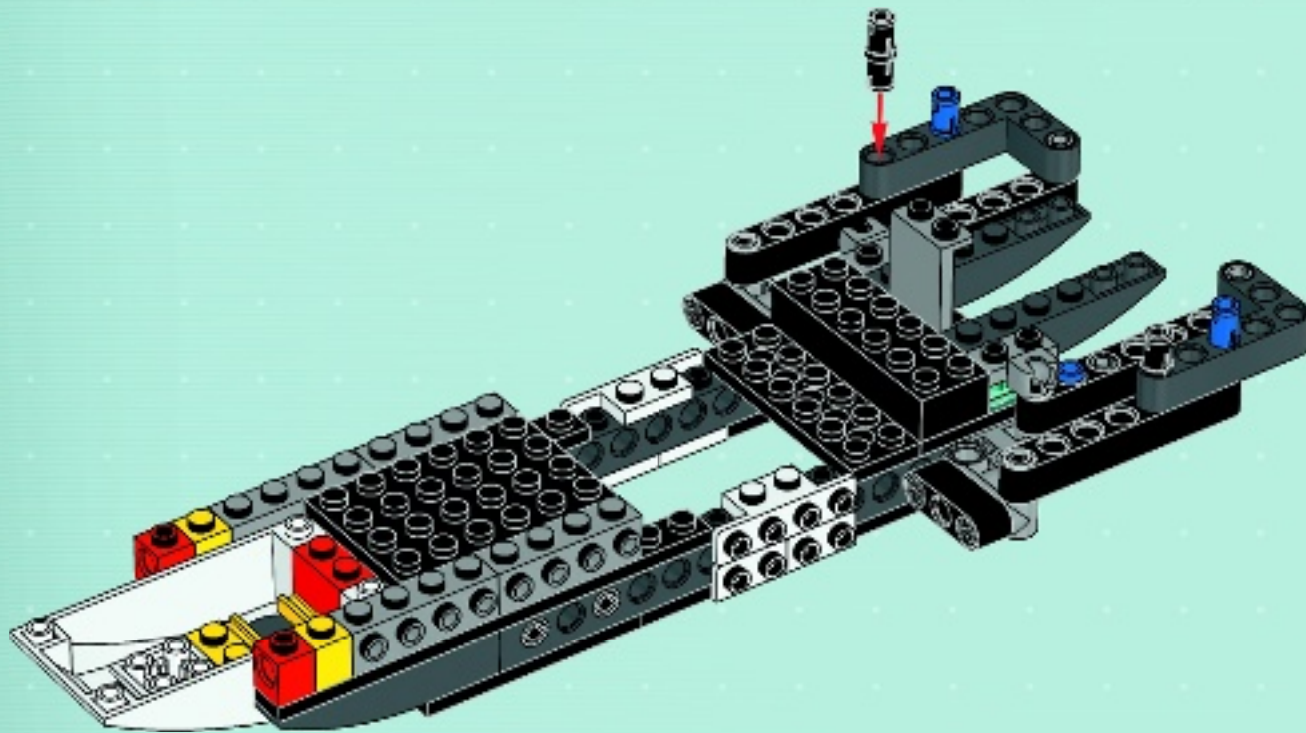

4x 4x 2x

20

1 2 2x

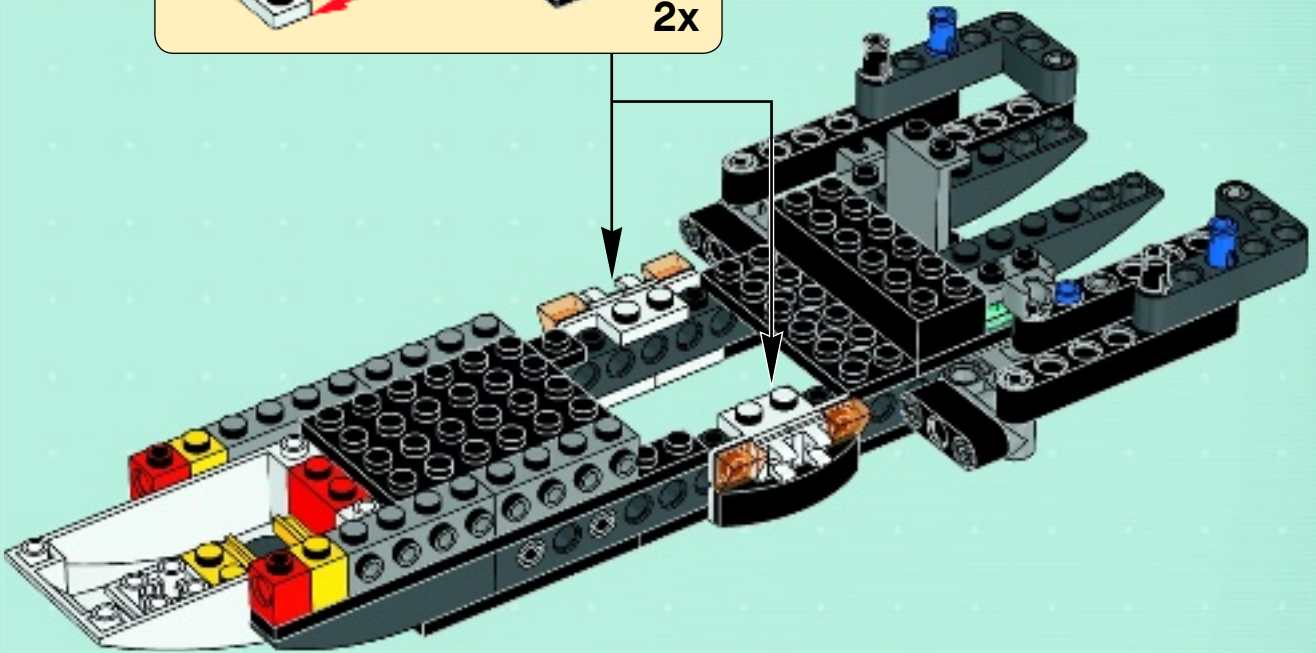



21

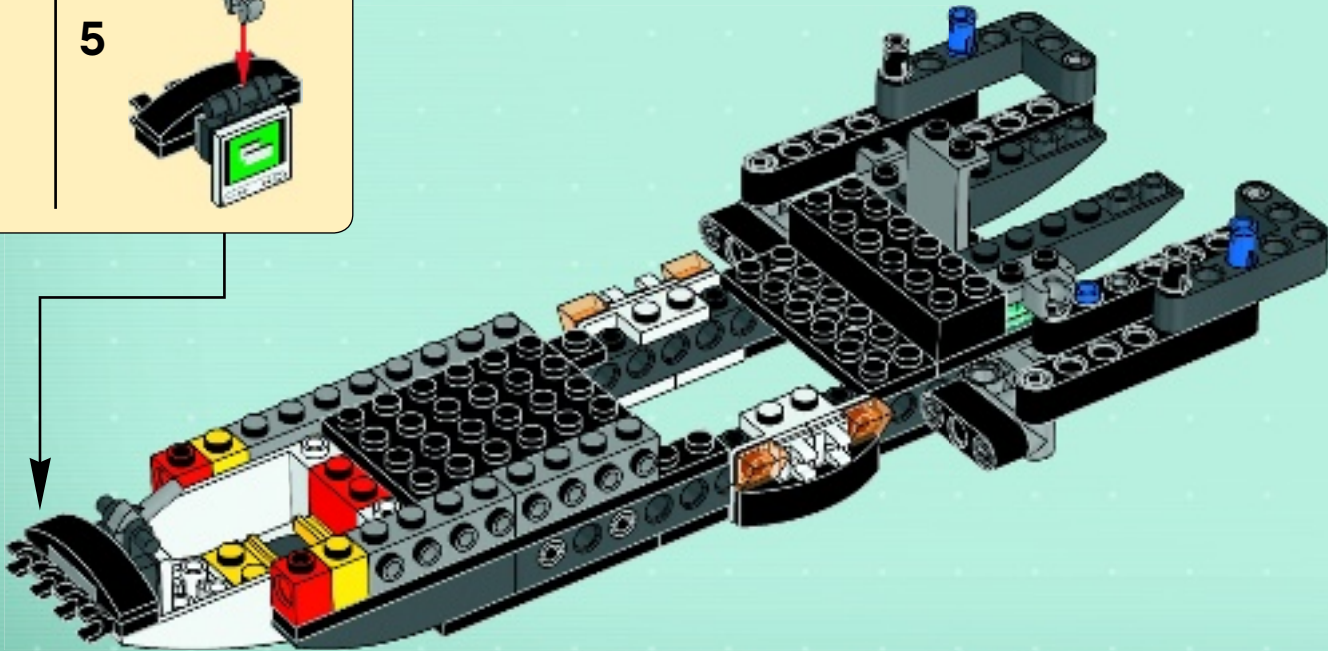
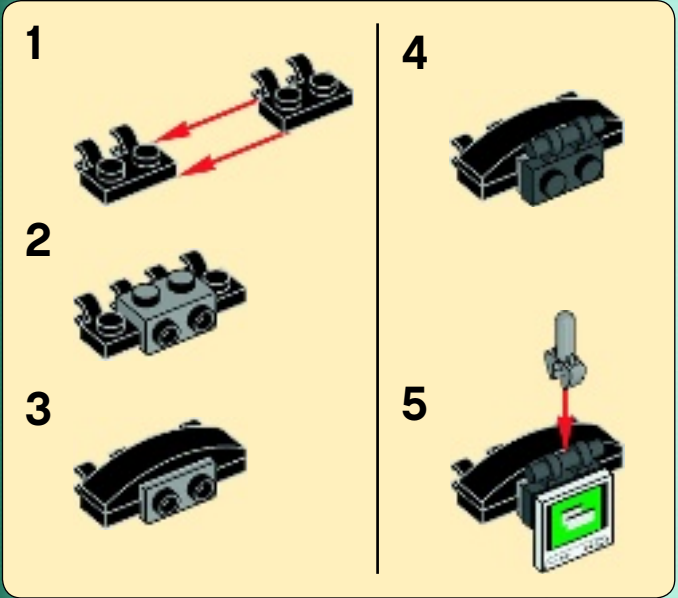

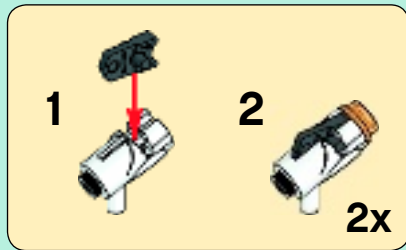
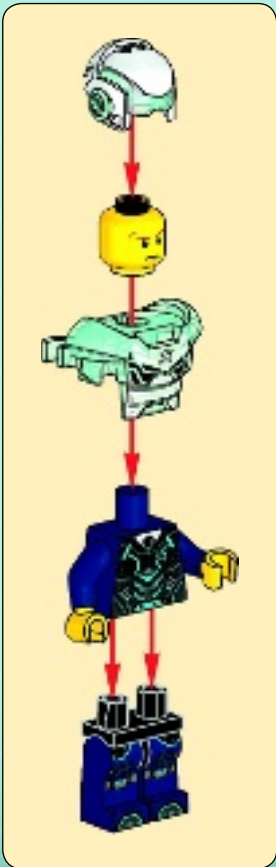
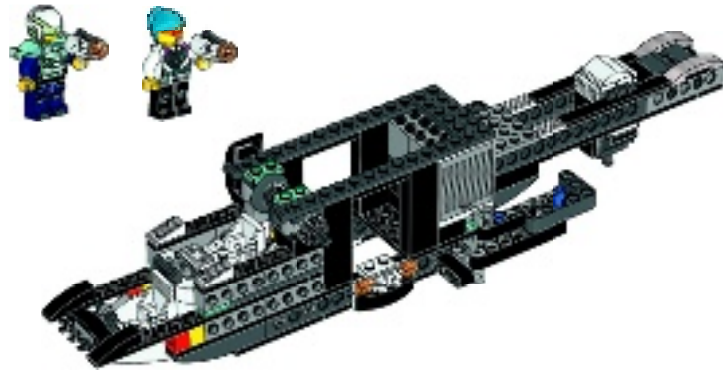



1

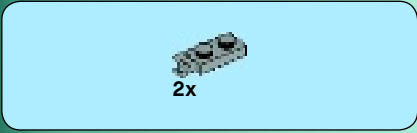

2

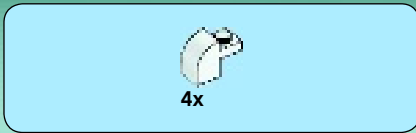

3

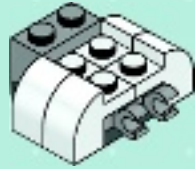

4



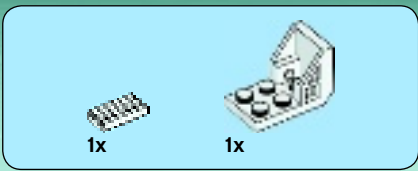

5

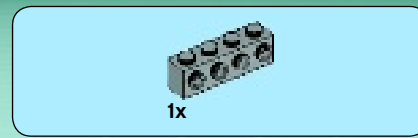

6

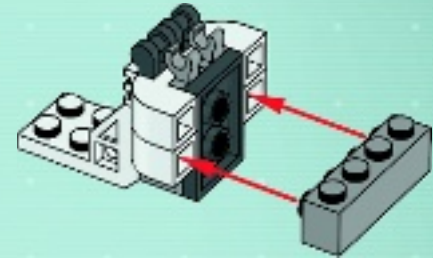
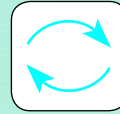

22

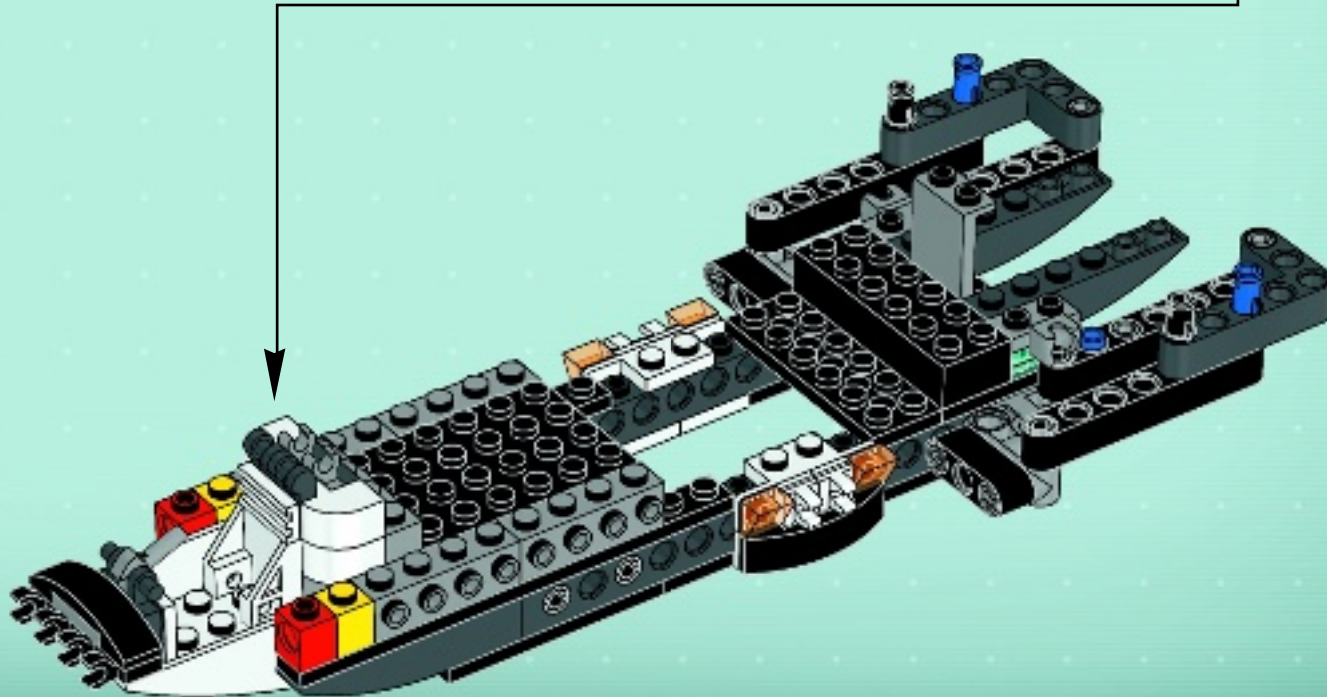

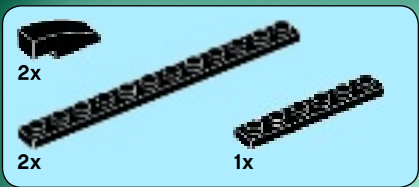

23

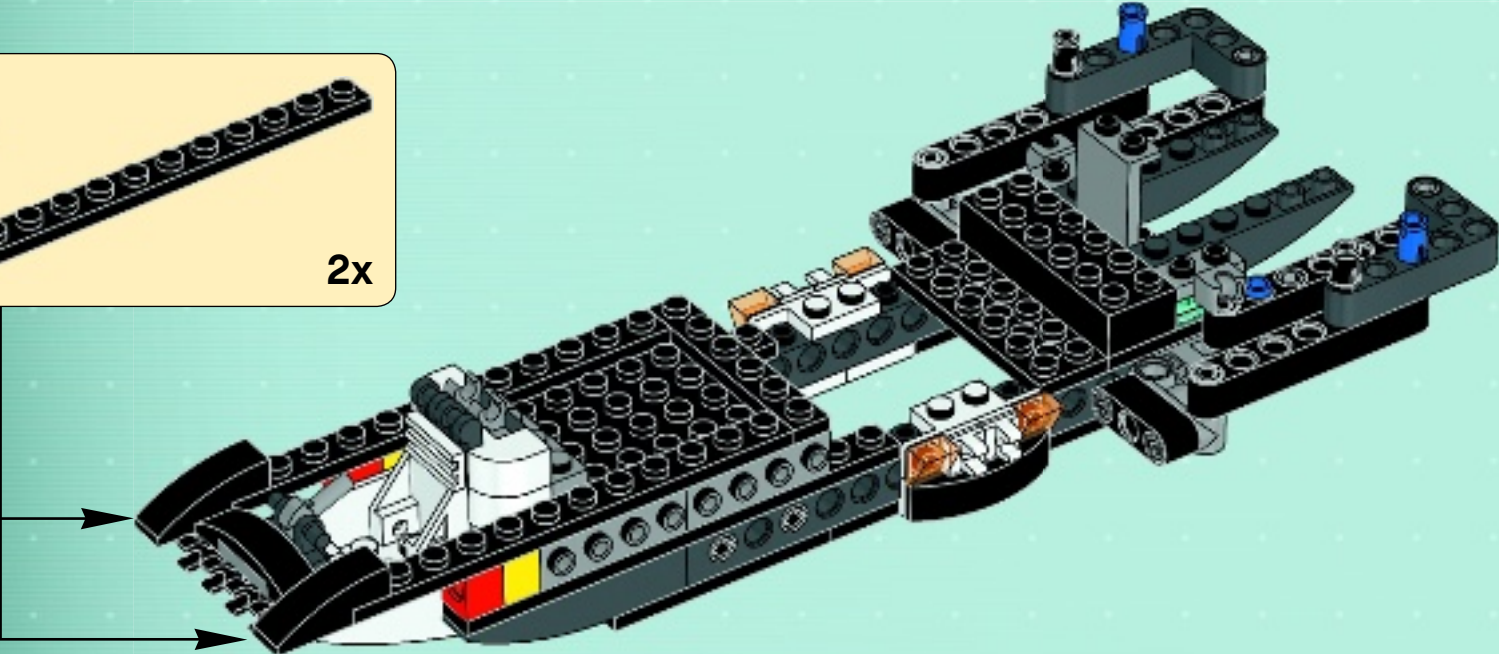
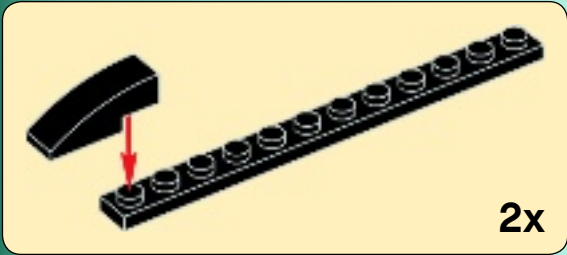



24

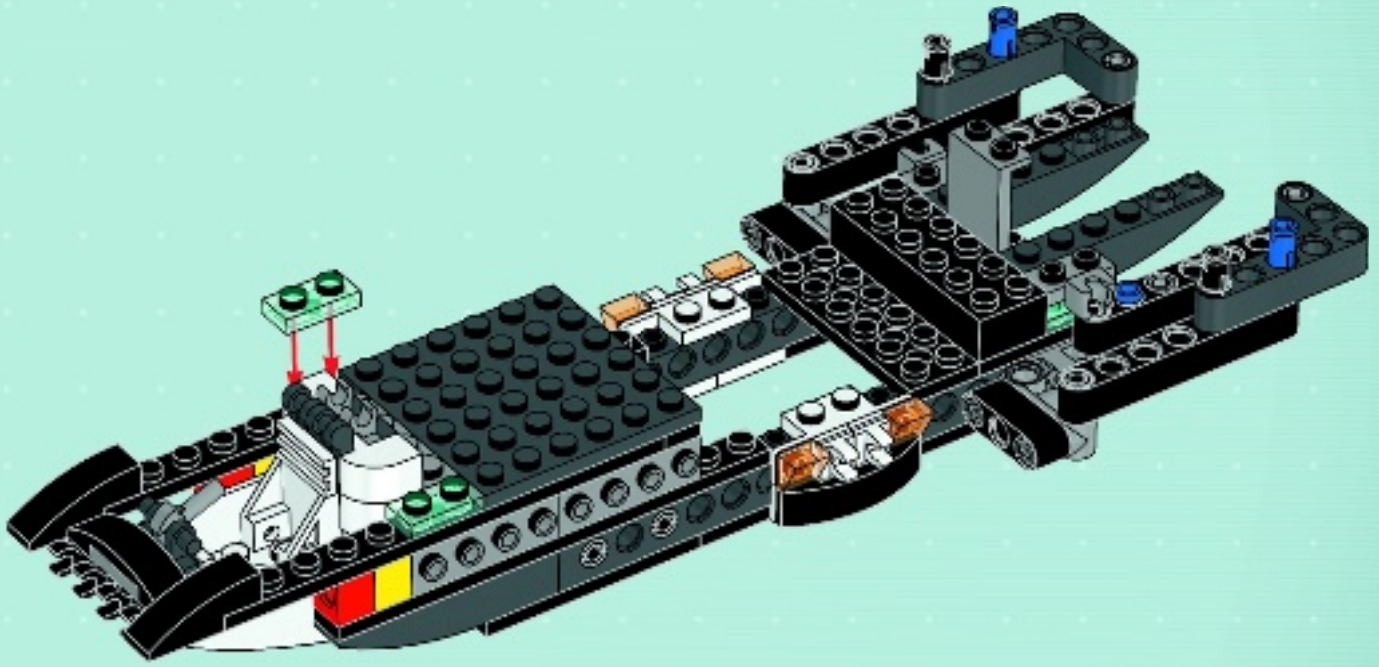



1x



2x



1x

25



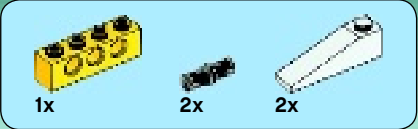

26

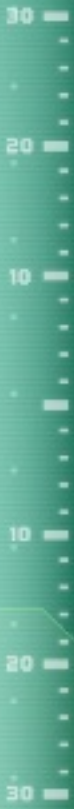
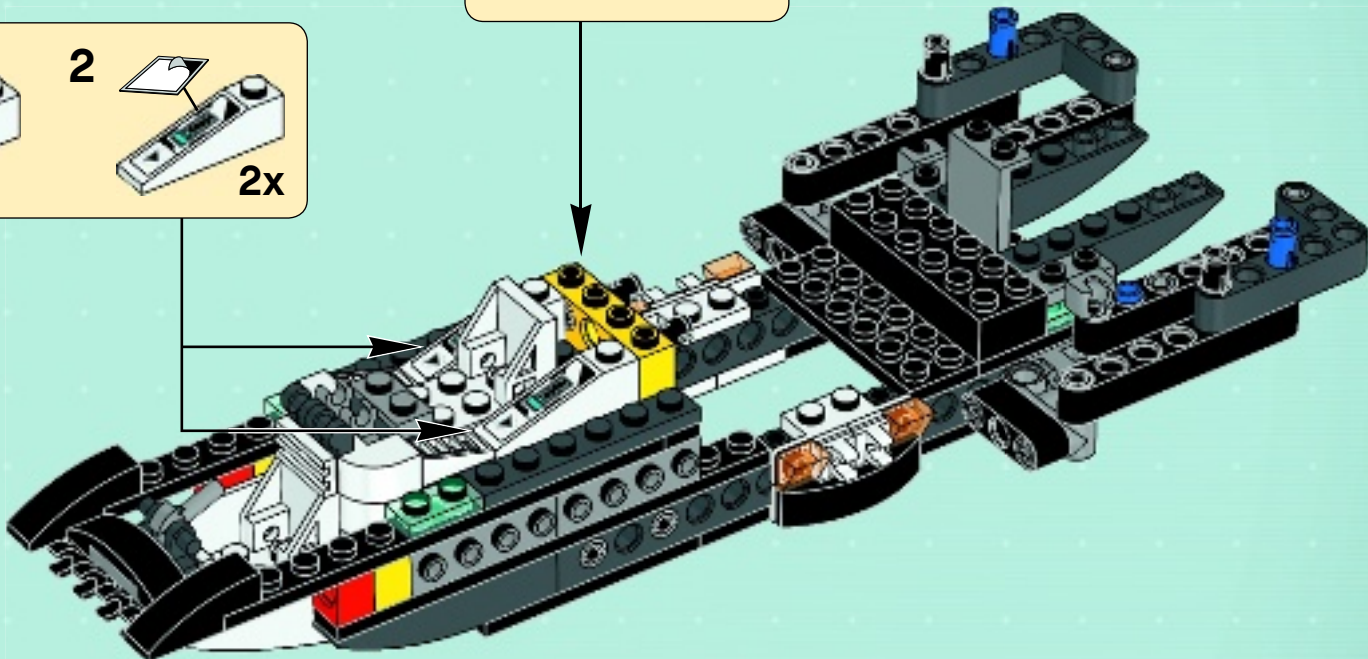
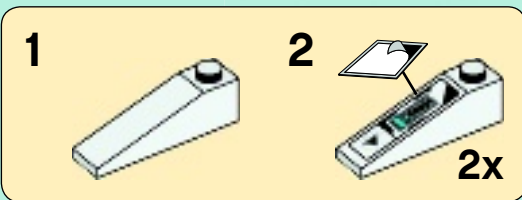
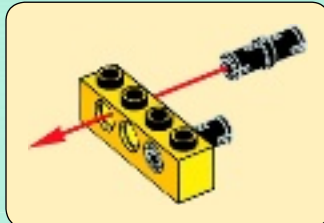



4x

27



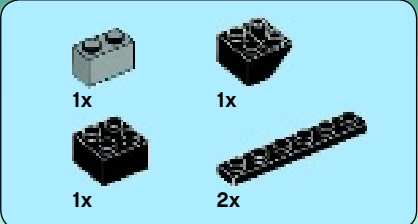

28

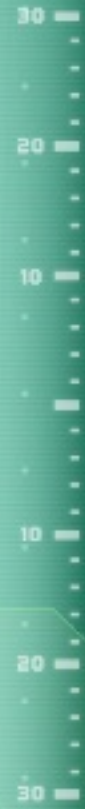
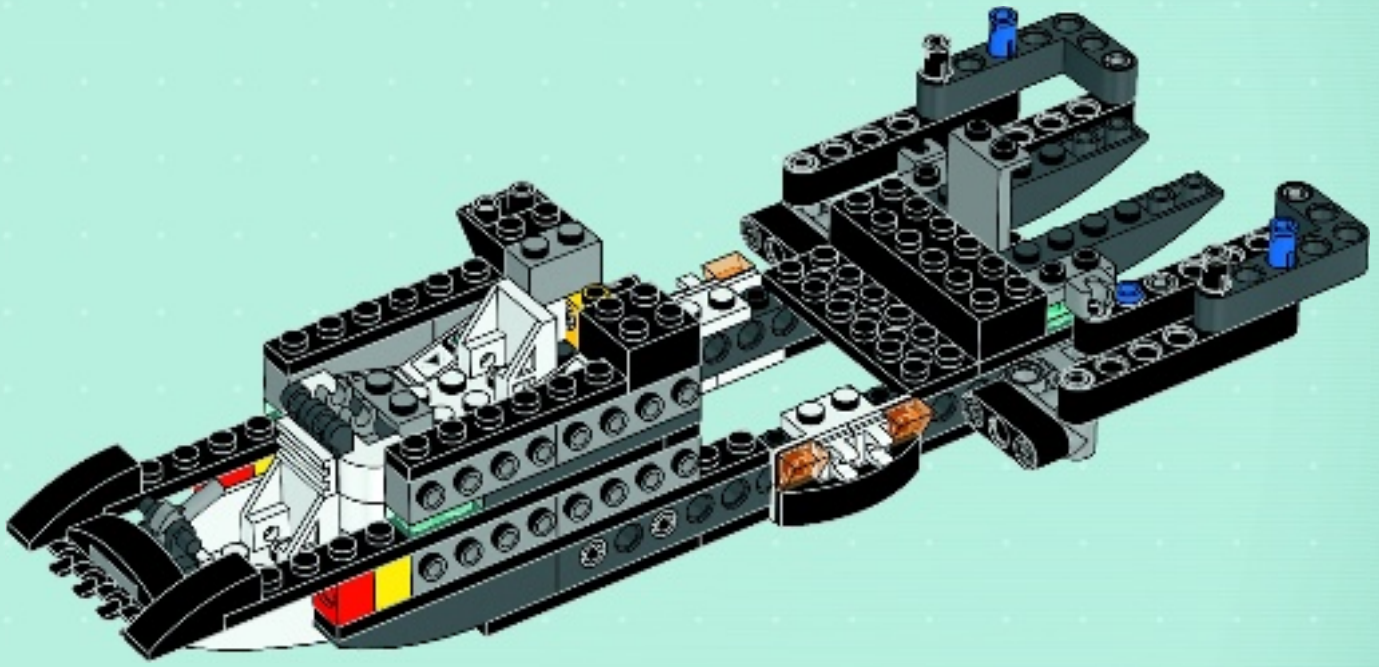



1x



2x

29

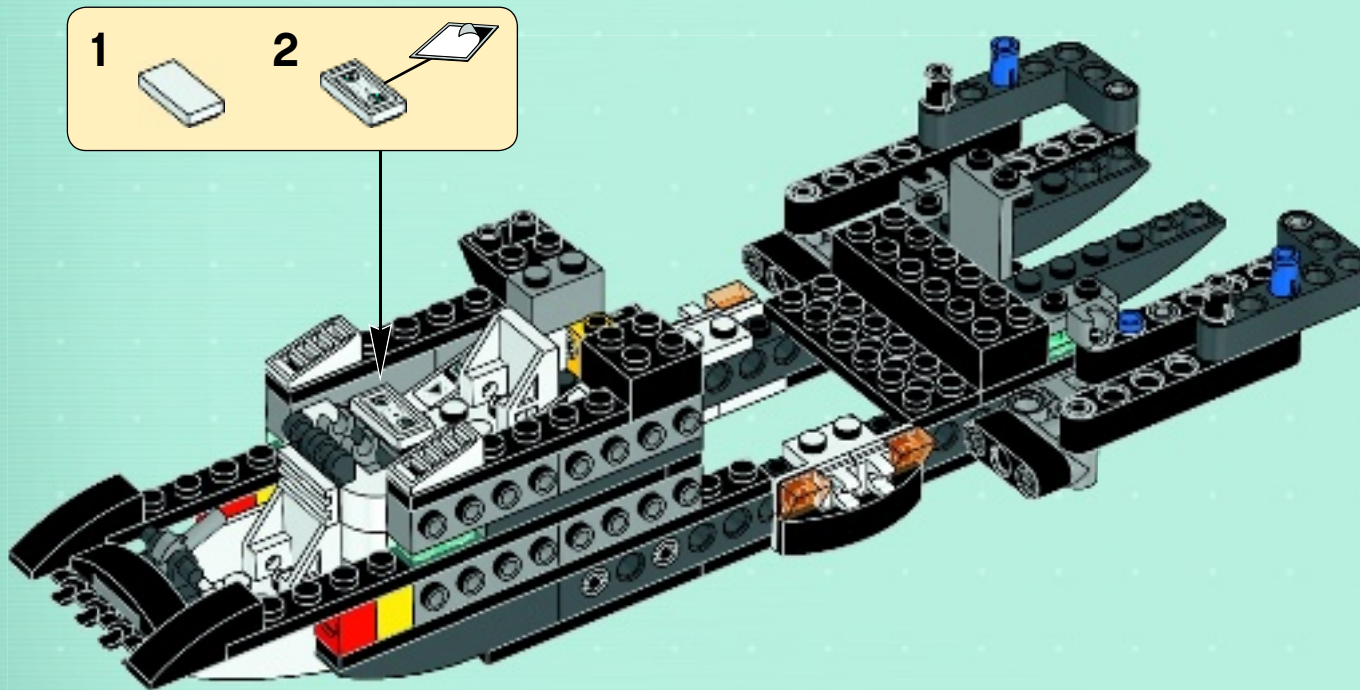

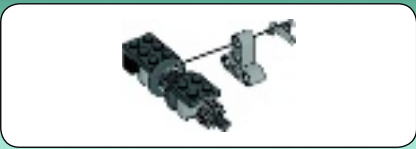

1



2

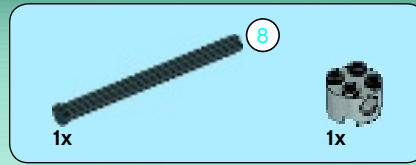
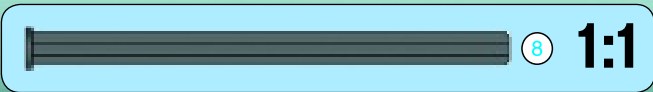

3

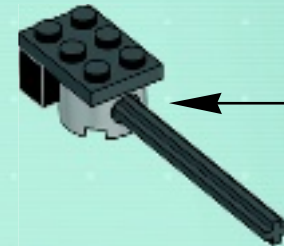
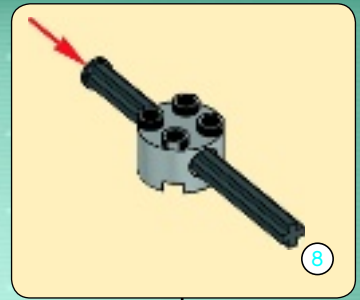

4

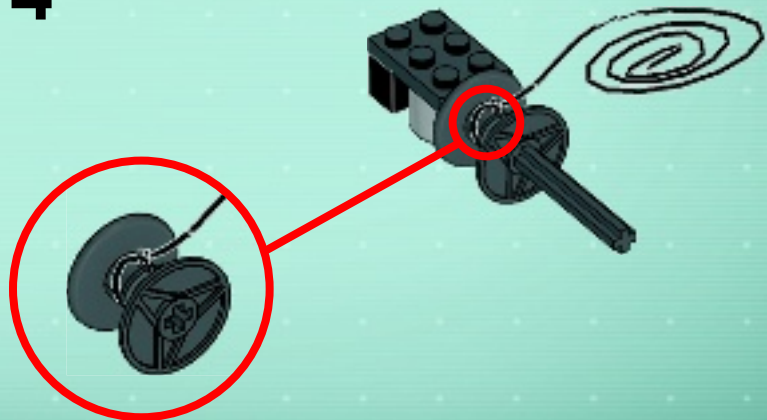



1x

5



1x



1x

6



1x



1x

7

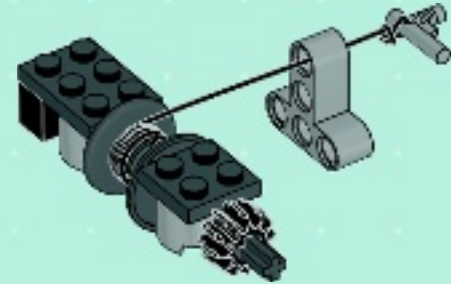

30

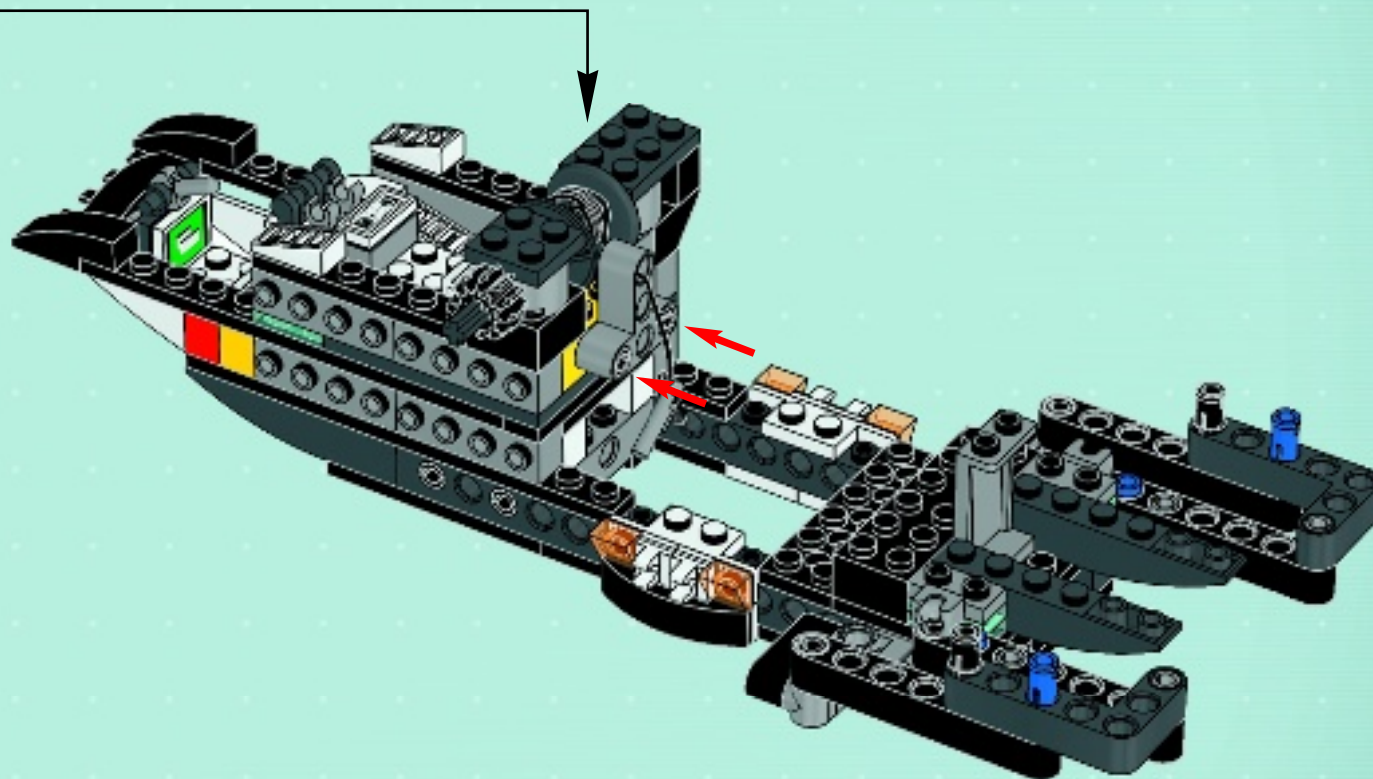
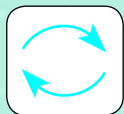



1x



2x



2x

31

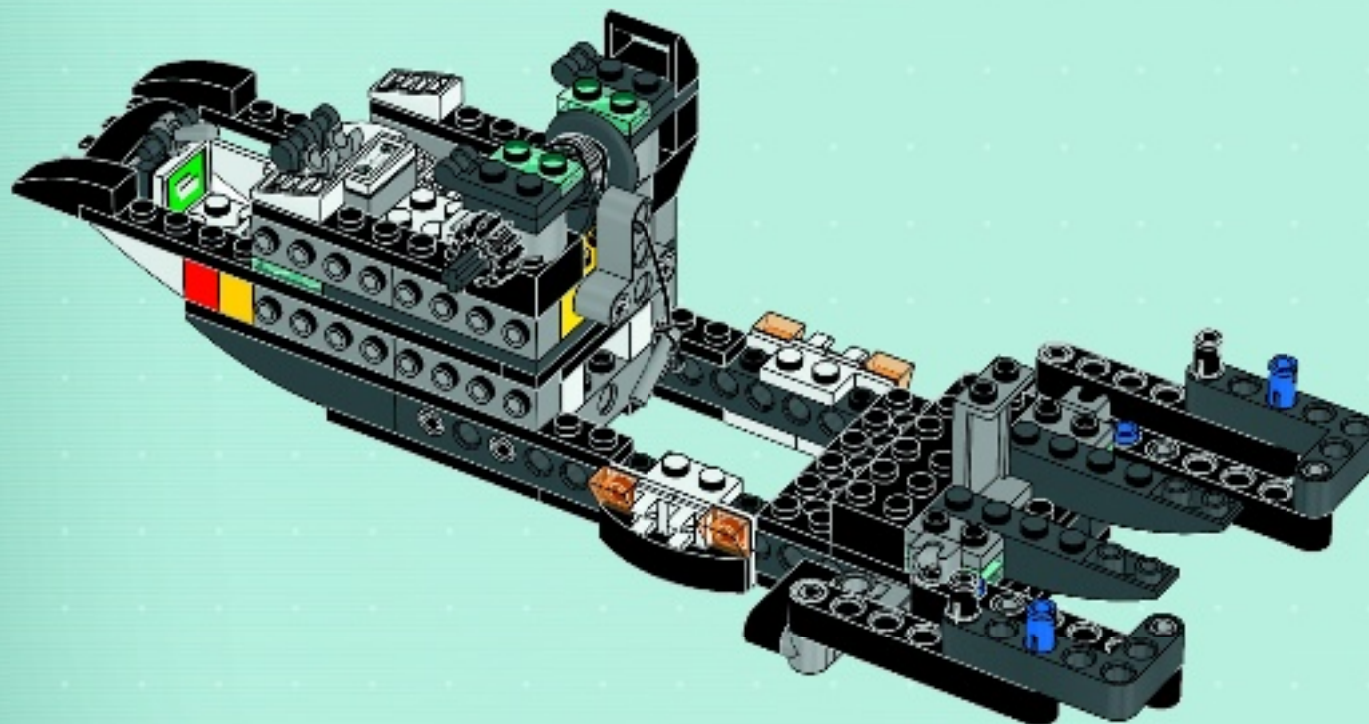



32

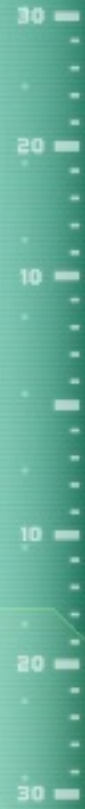
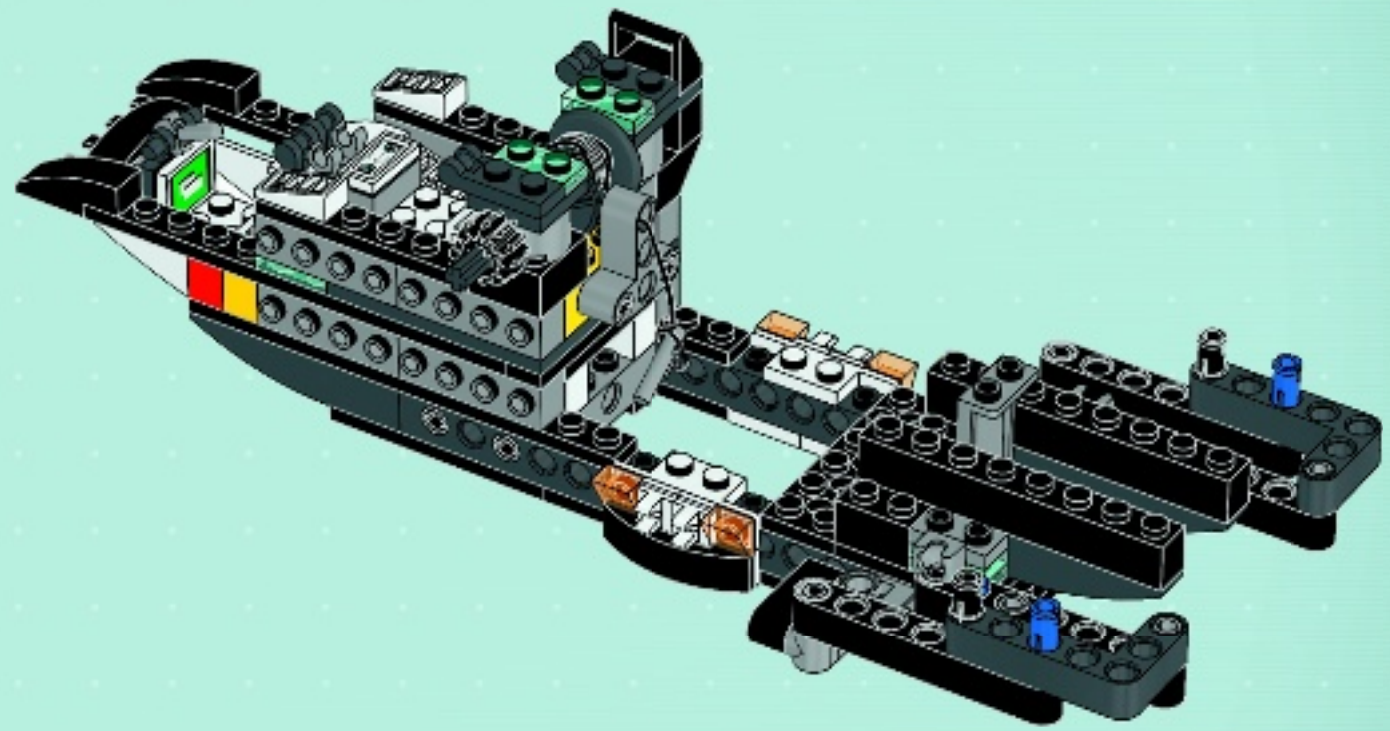

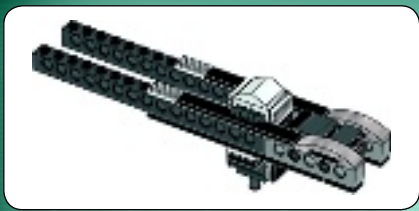

1



2



3



4

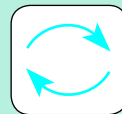

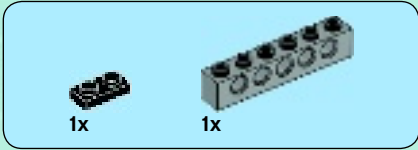

1



2

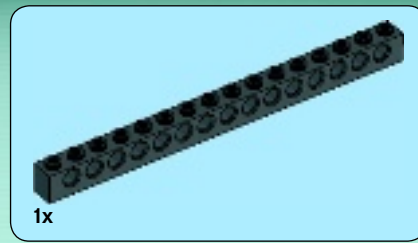

3

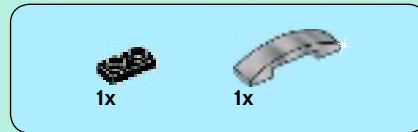
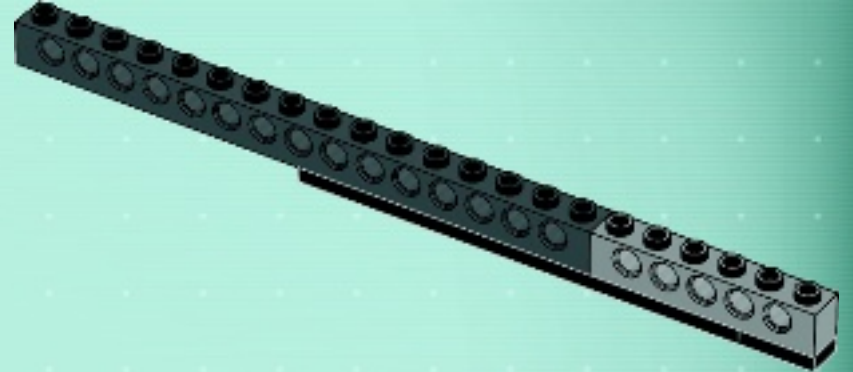

4

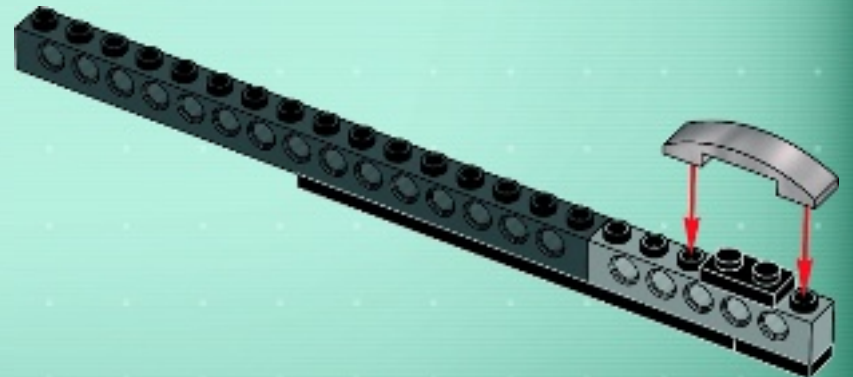

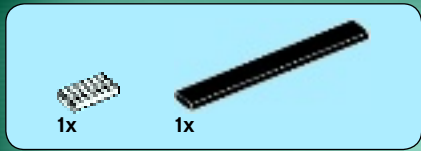

5

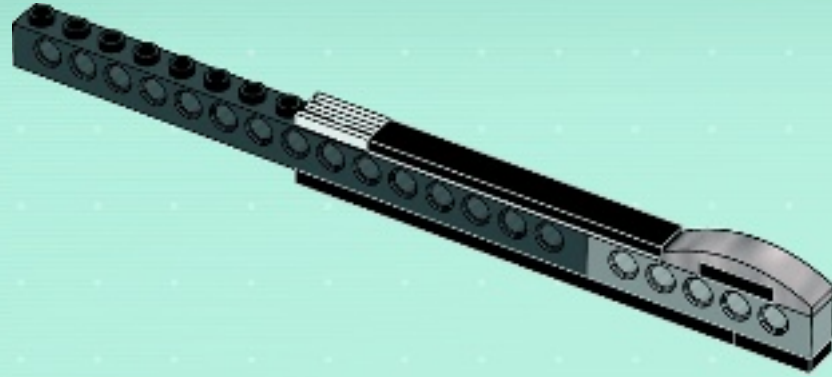

2x

6

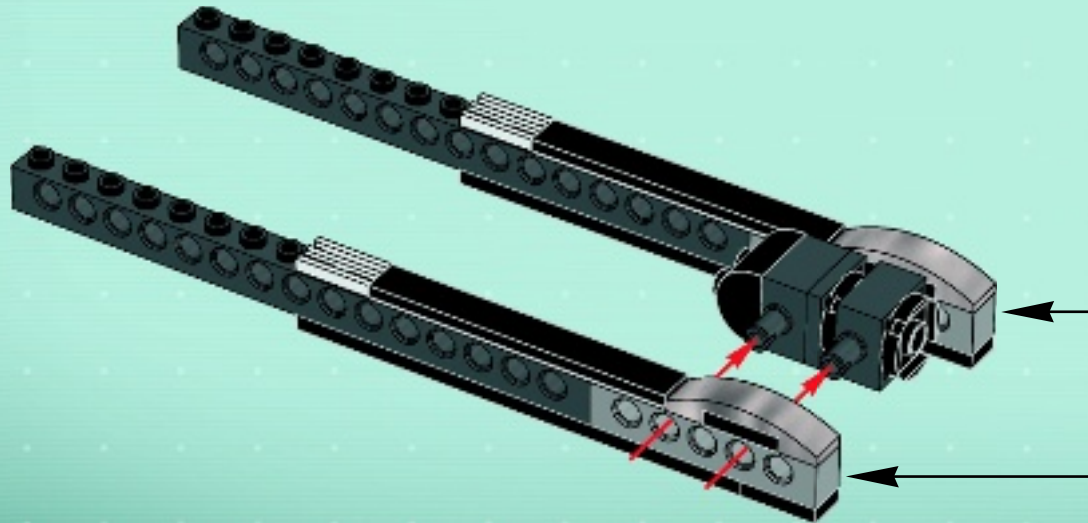



1x

1



2x

2



2x

3



1x

4





2x

5



2x

6



2x

7



2x



1x

8

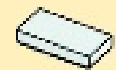

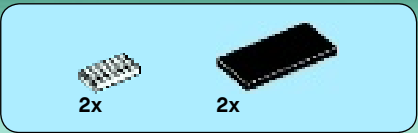

9

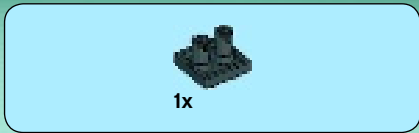
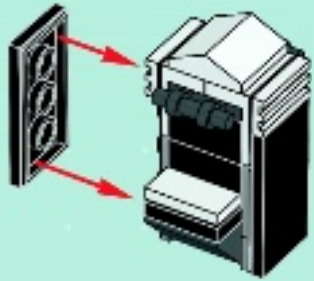

10



11

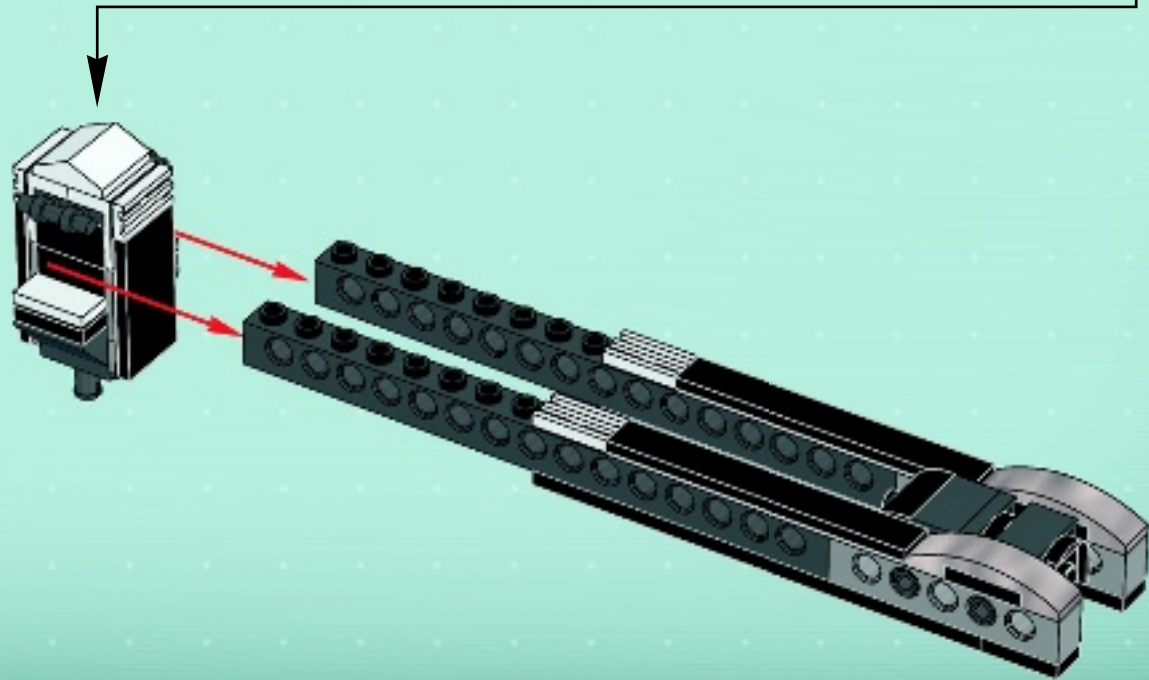

33

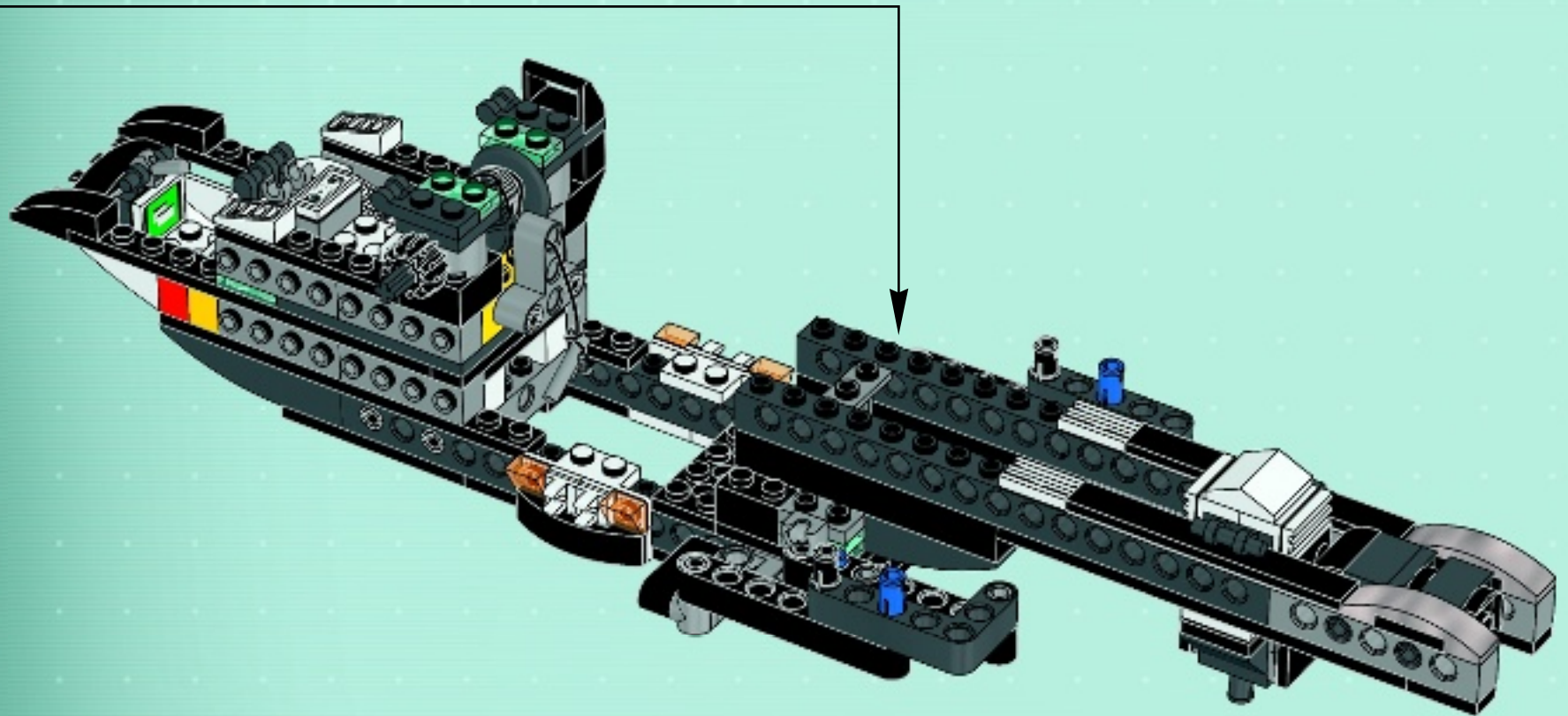

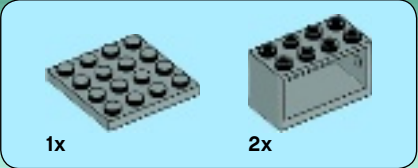

34

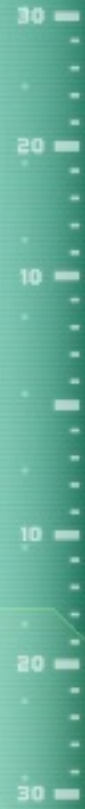
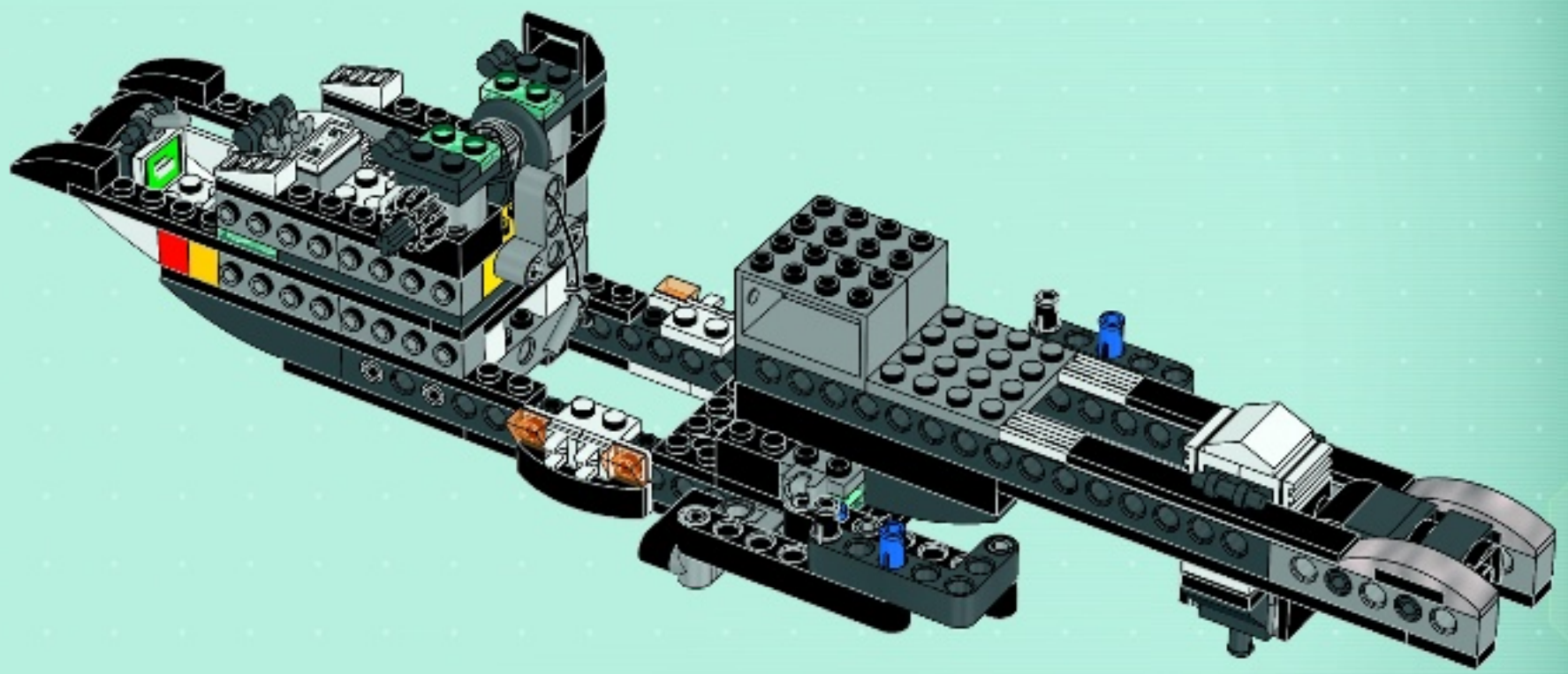

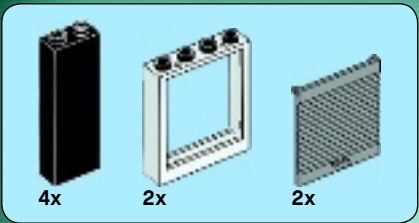

35

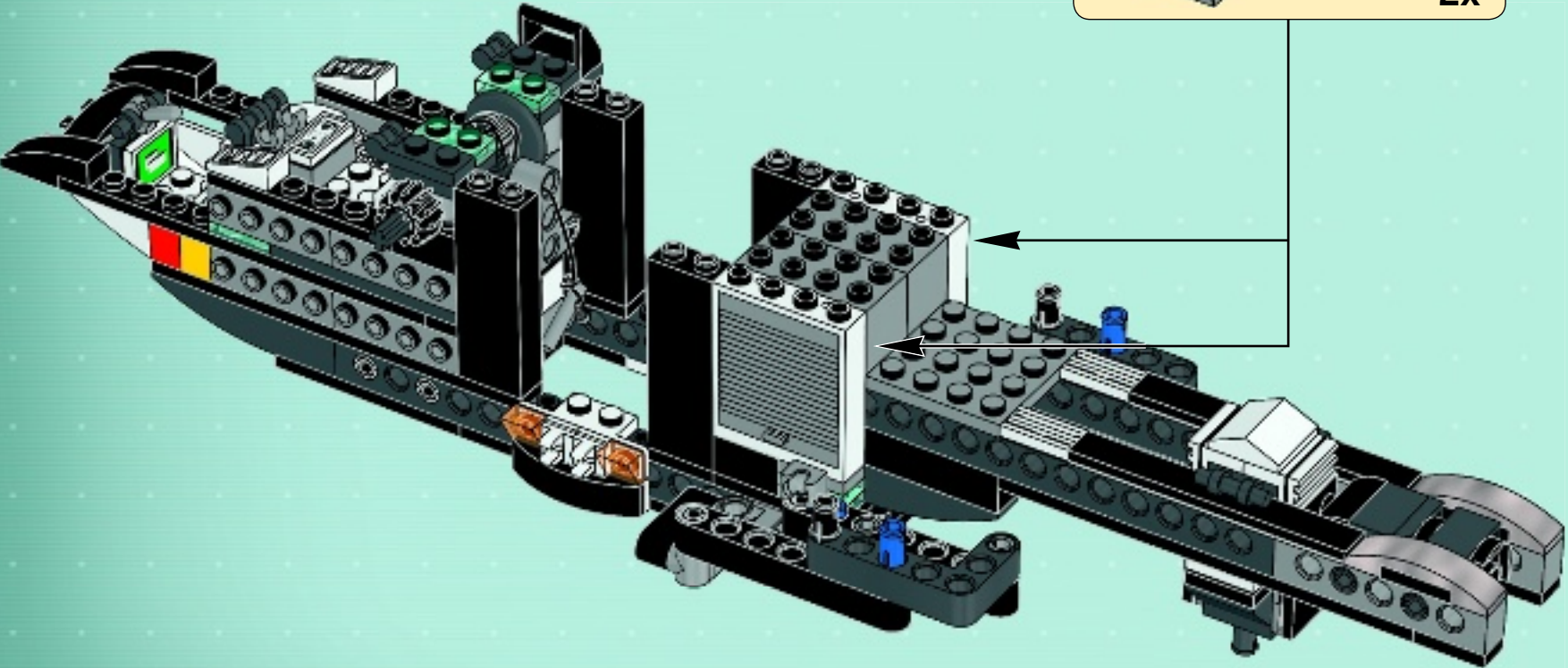
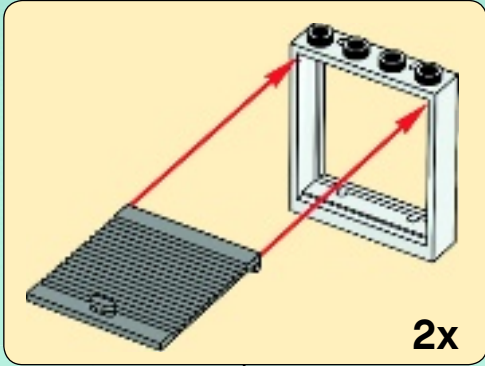

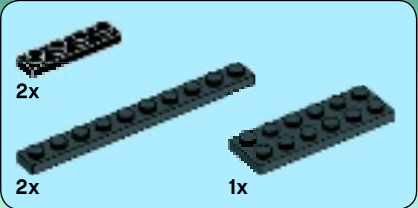

36

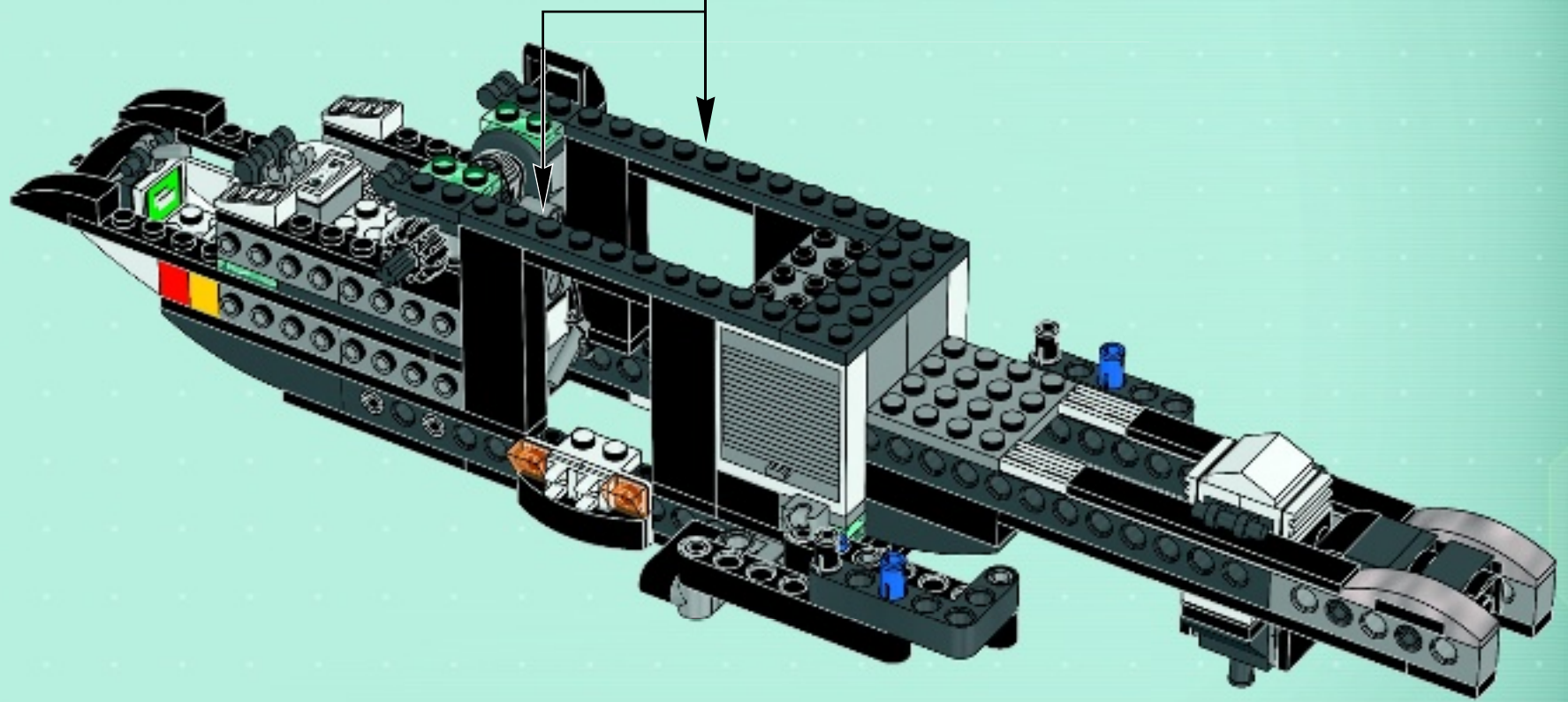
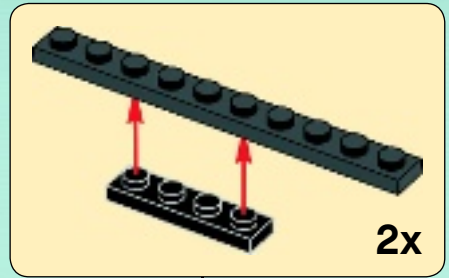

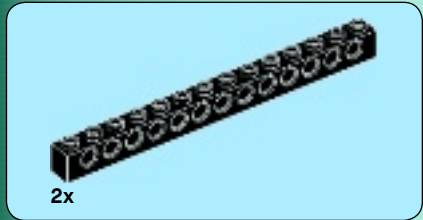
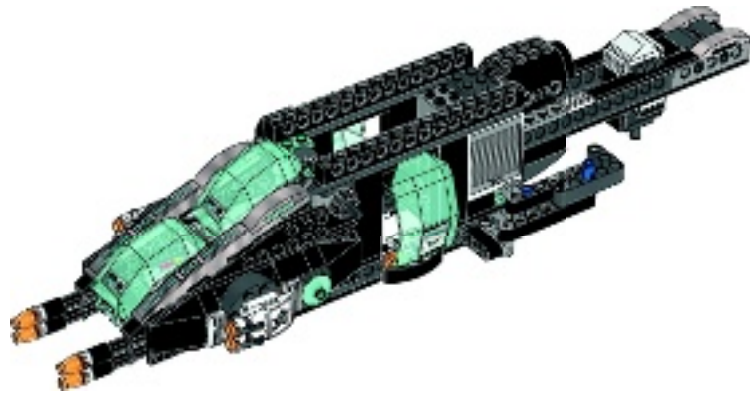

37

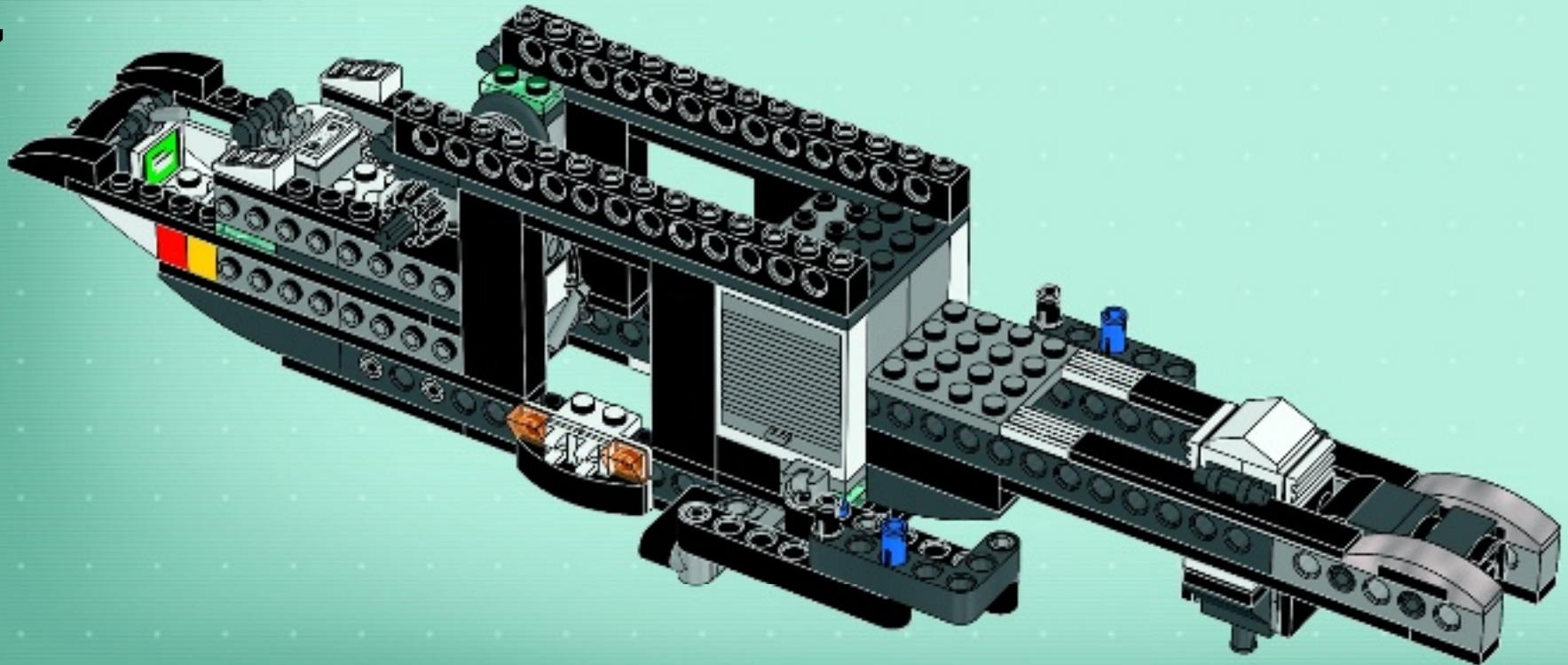

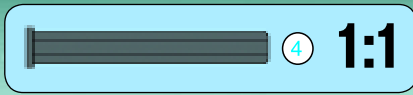

38

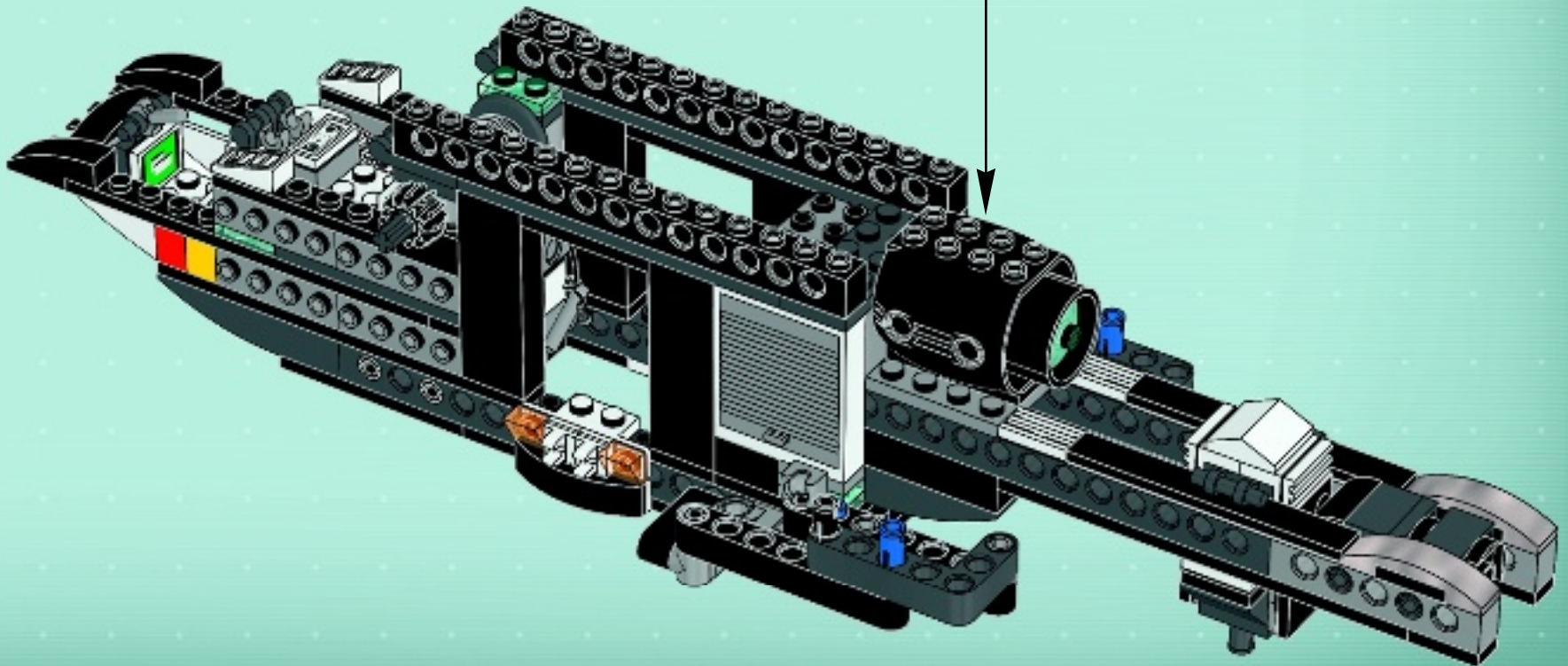
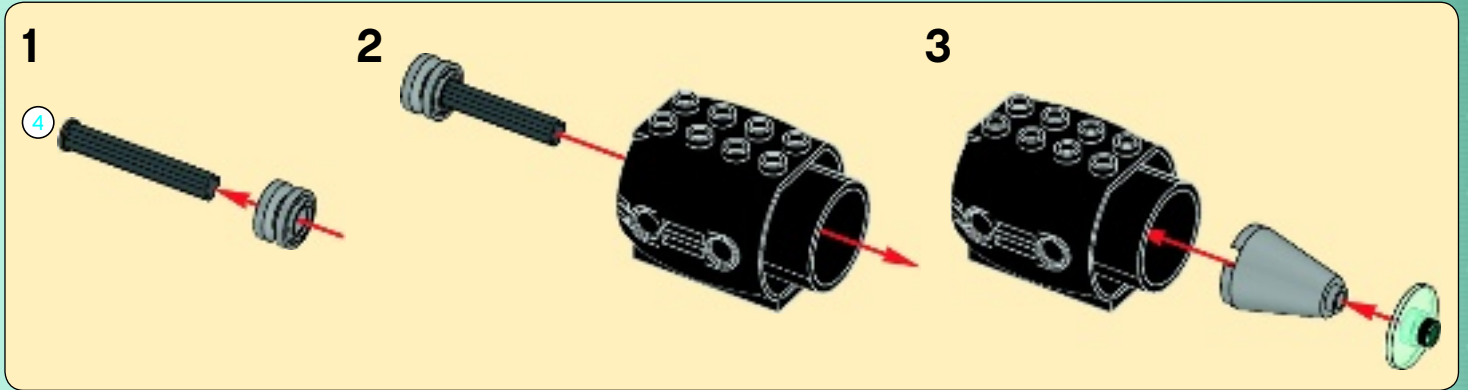

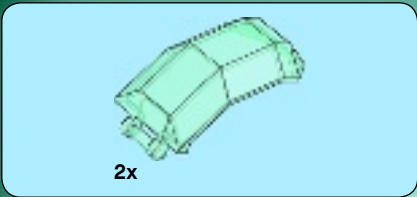

39

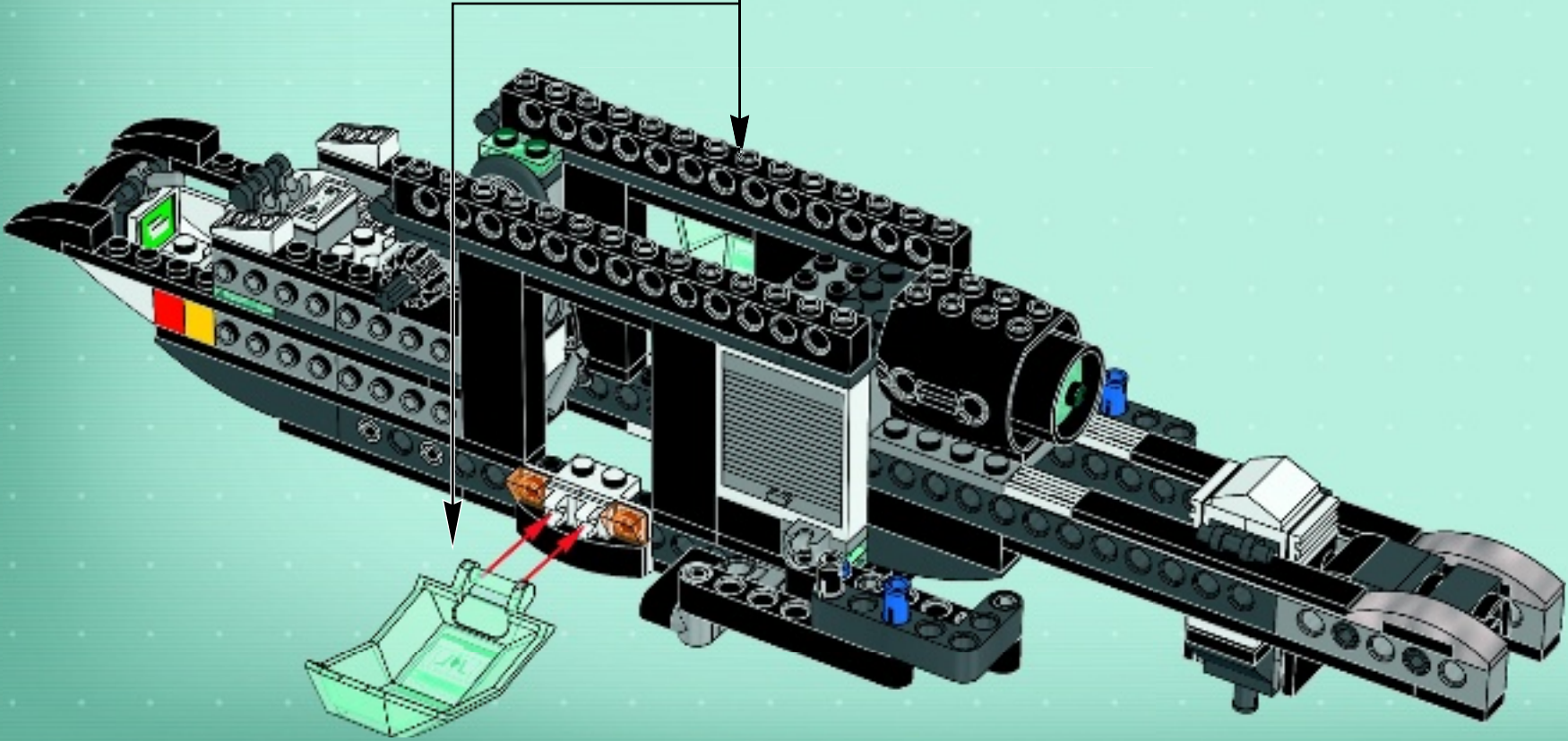
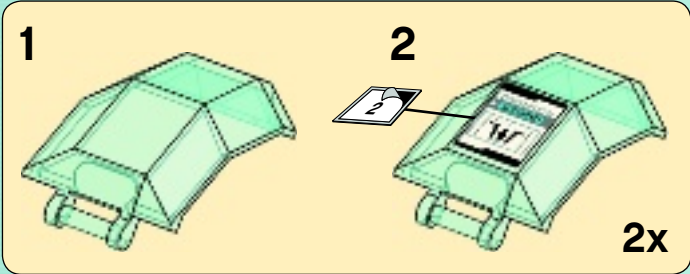



40

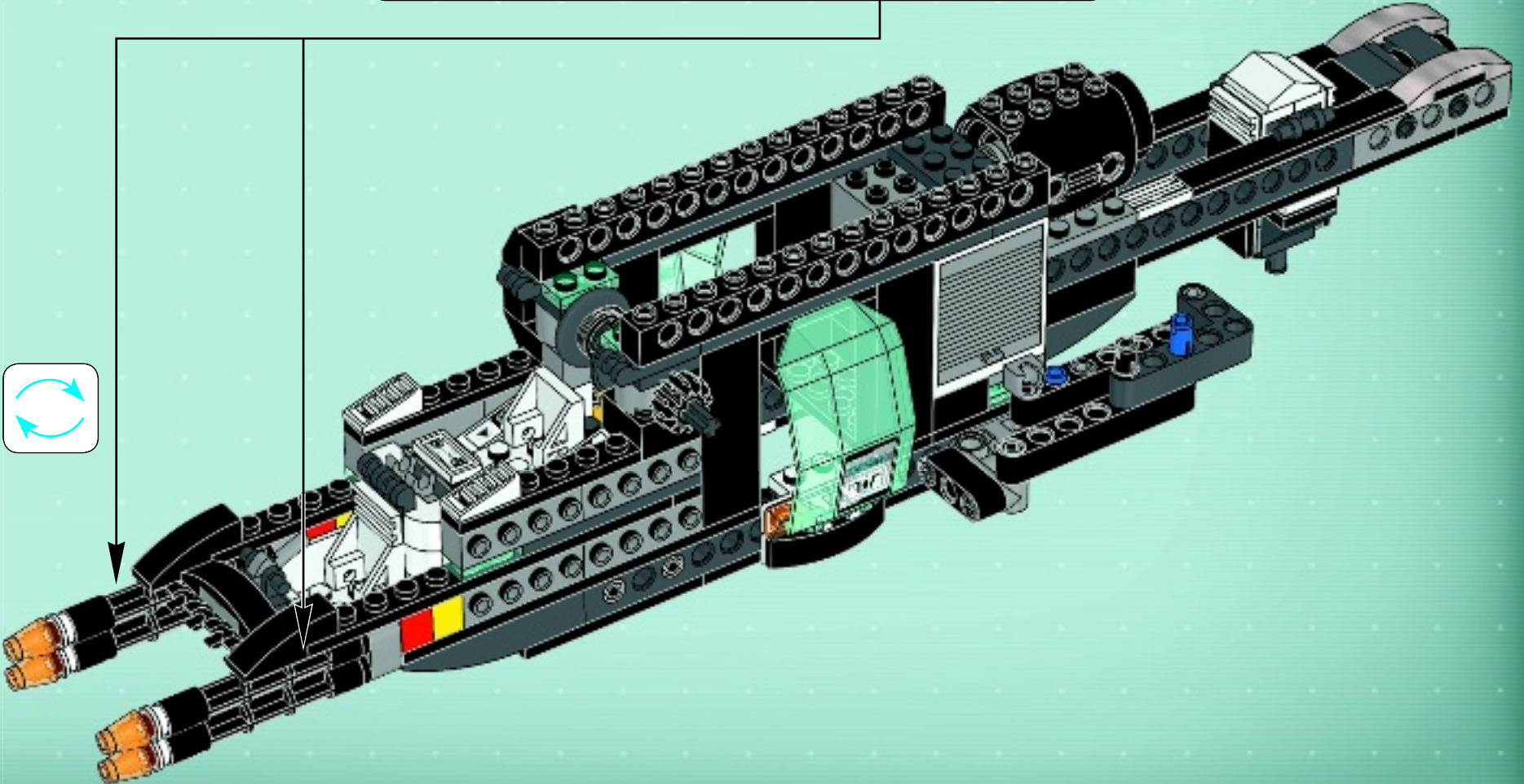
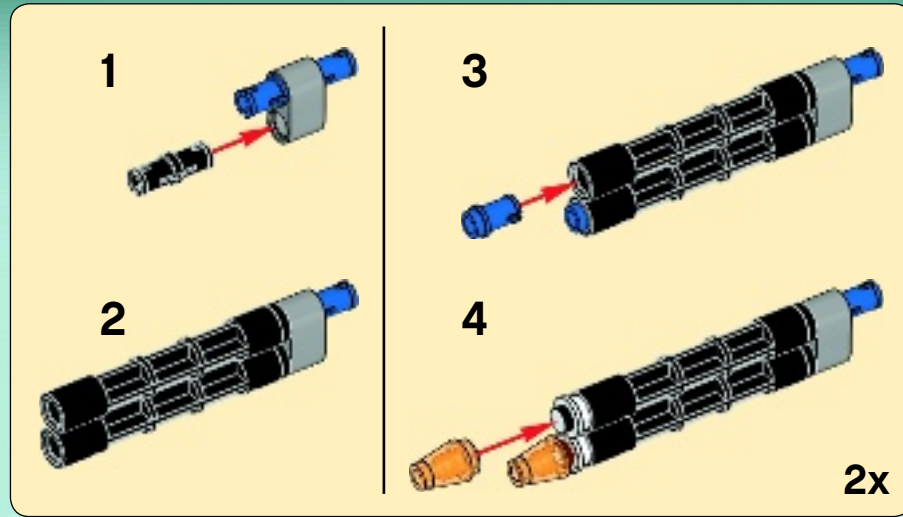

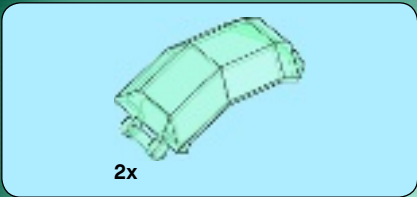

41

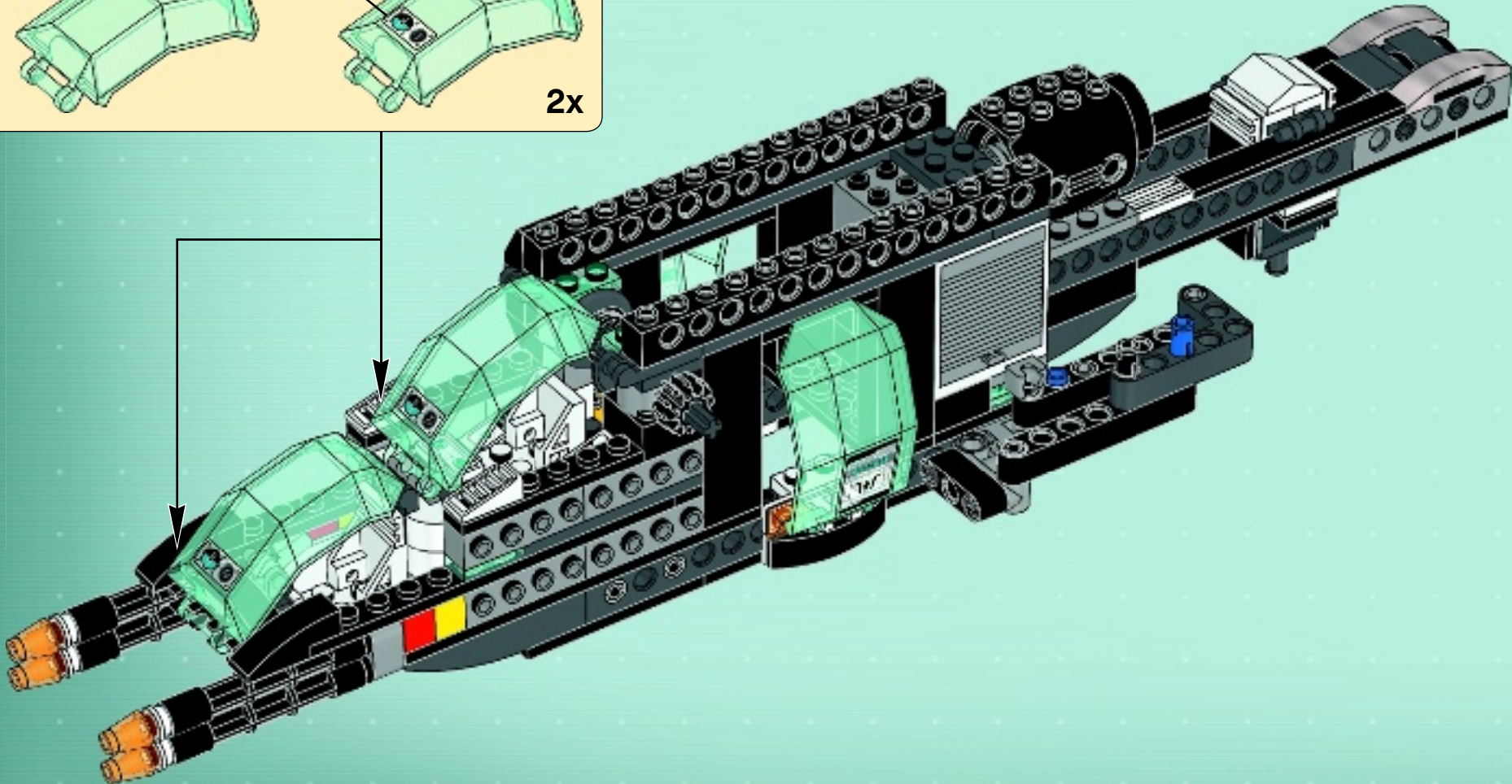
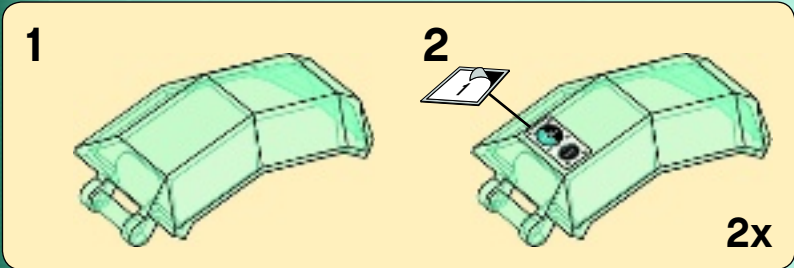

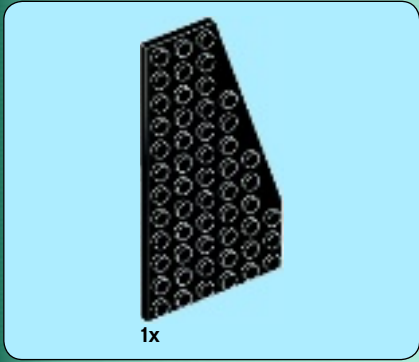
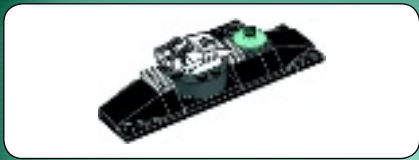

1

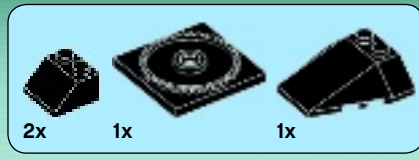
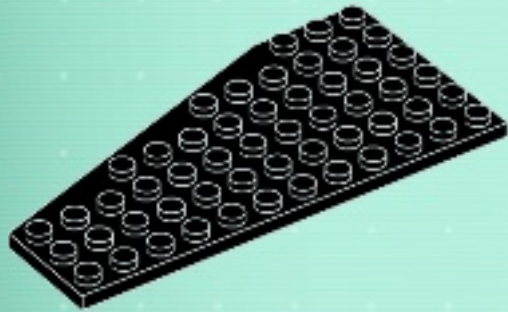

2

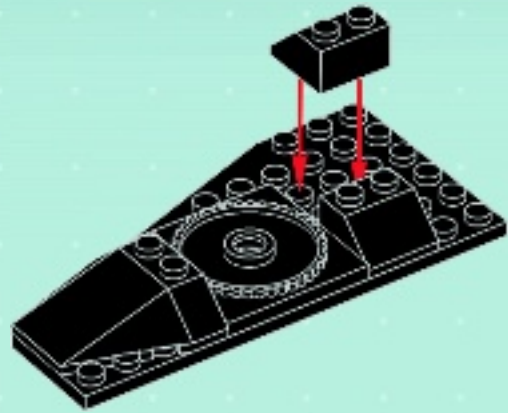

3





4



5



6

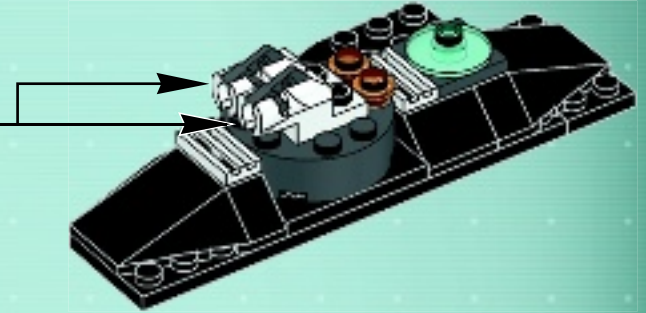
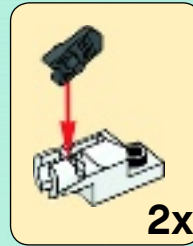

7

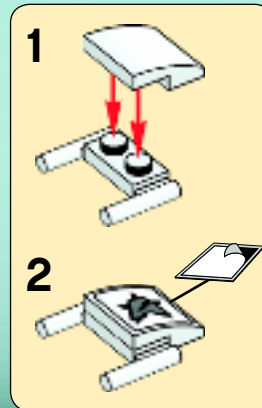

43

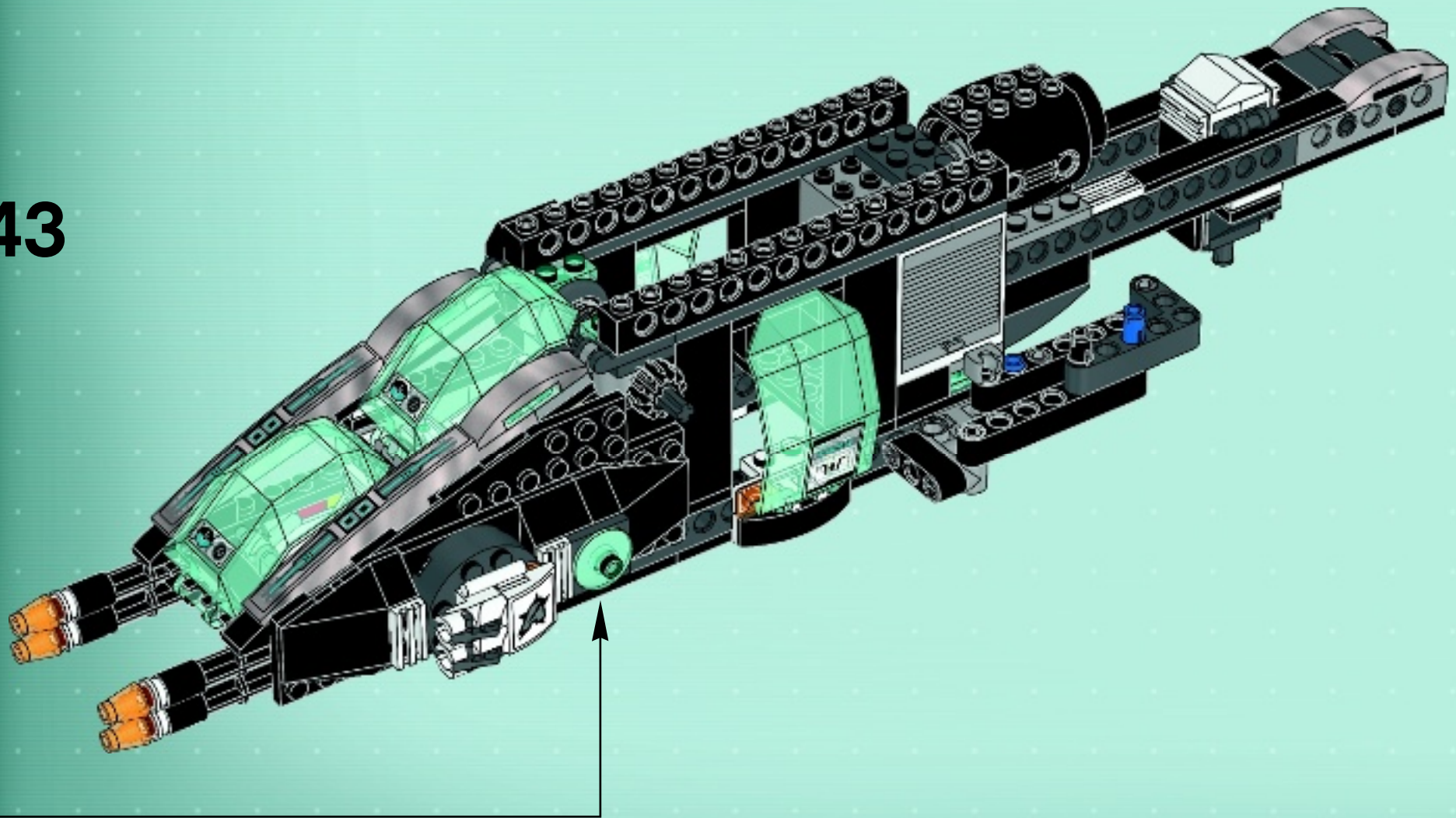

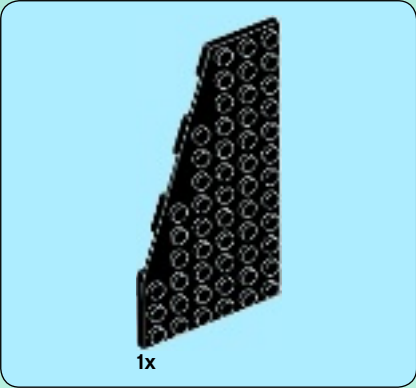
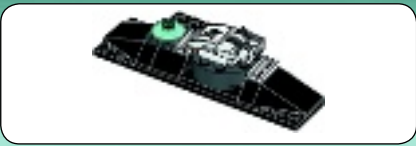

1



2

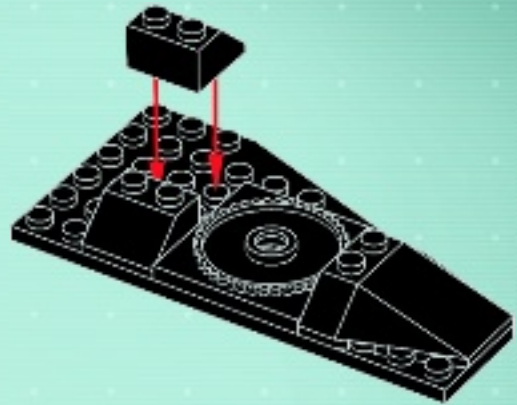

3

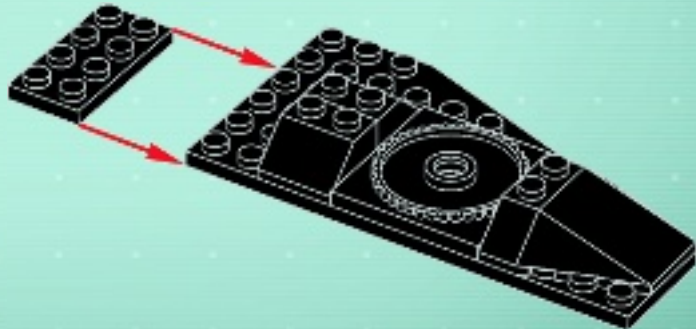



1x

4

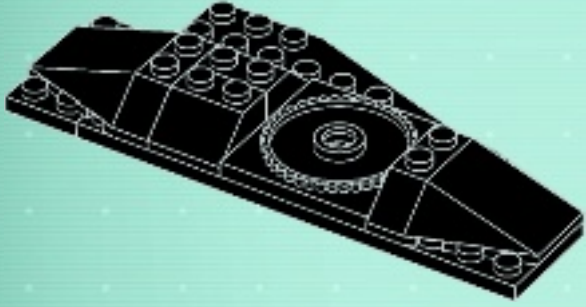

2x



1x



1x

5



2x



2x



1x



2x



6

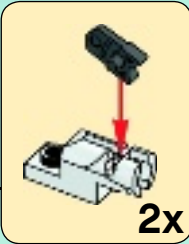

1x



1x

7

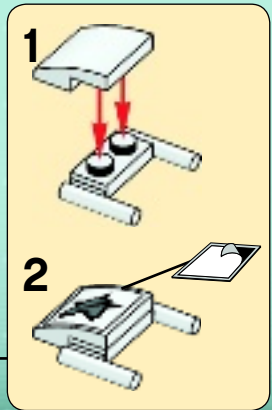

44

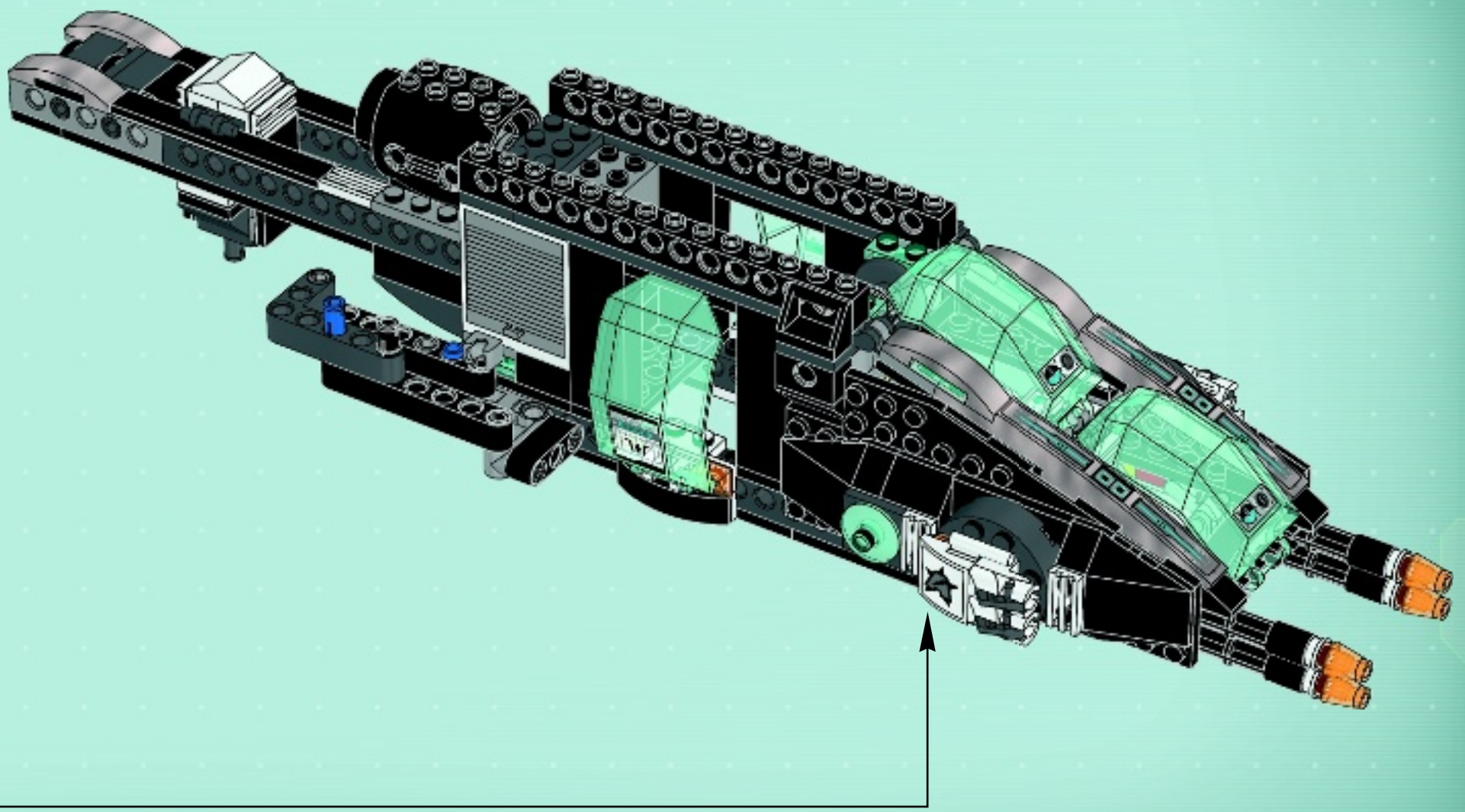
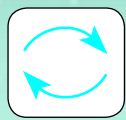

30
20
10
10
20
30



4x



45

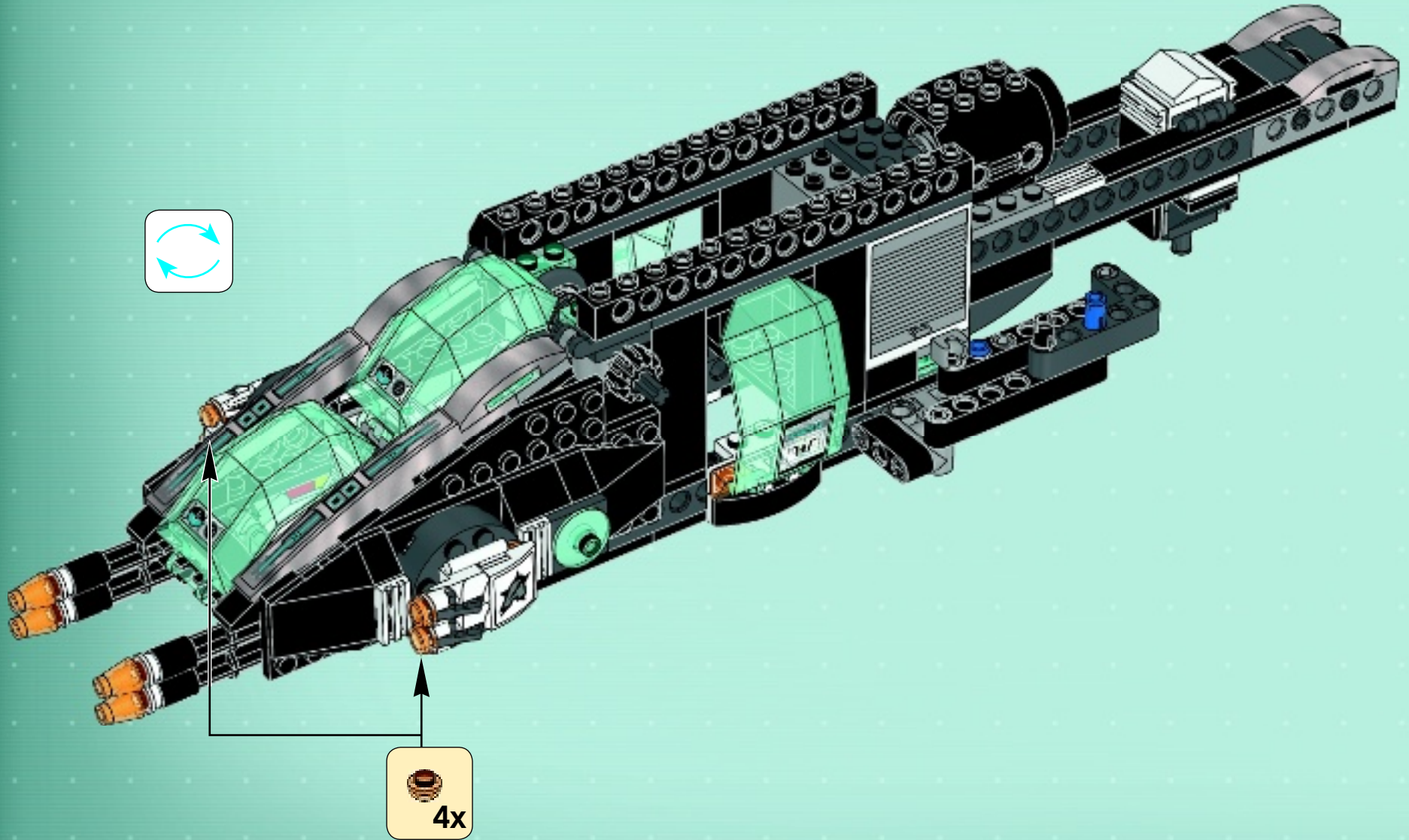
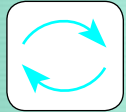



4

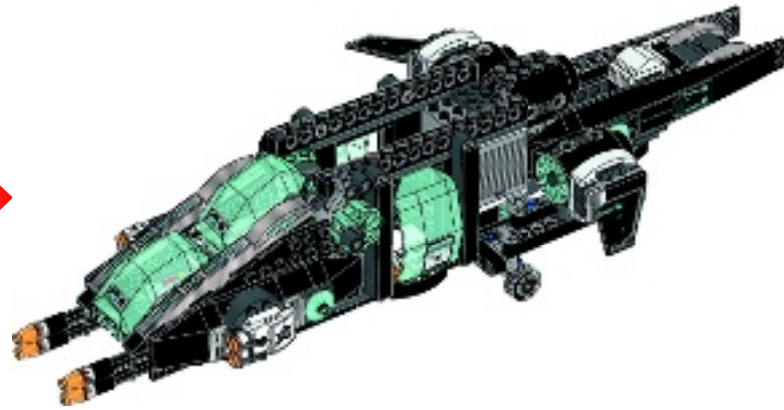

46

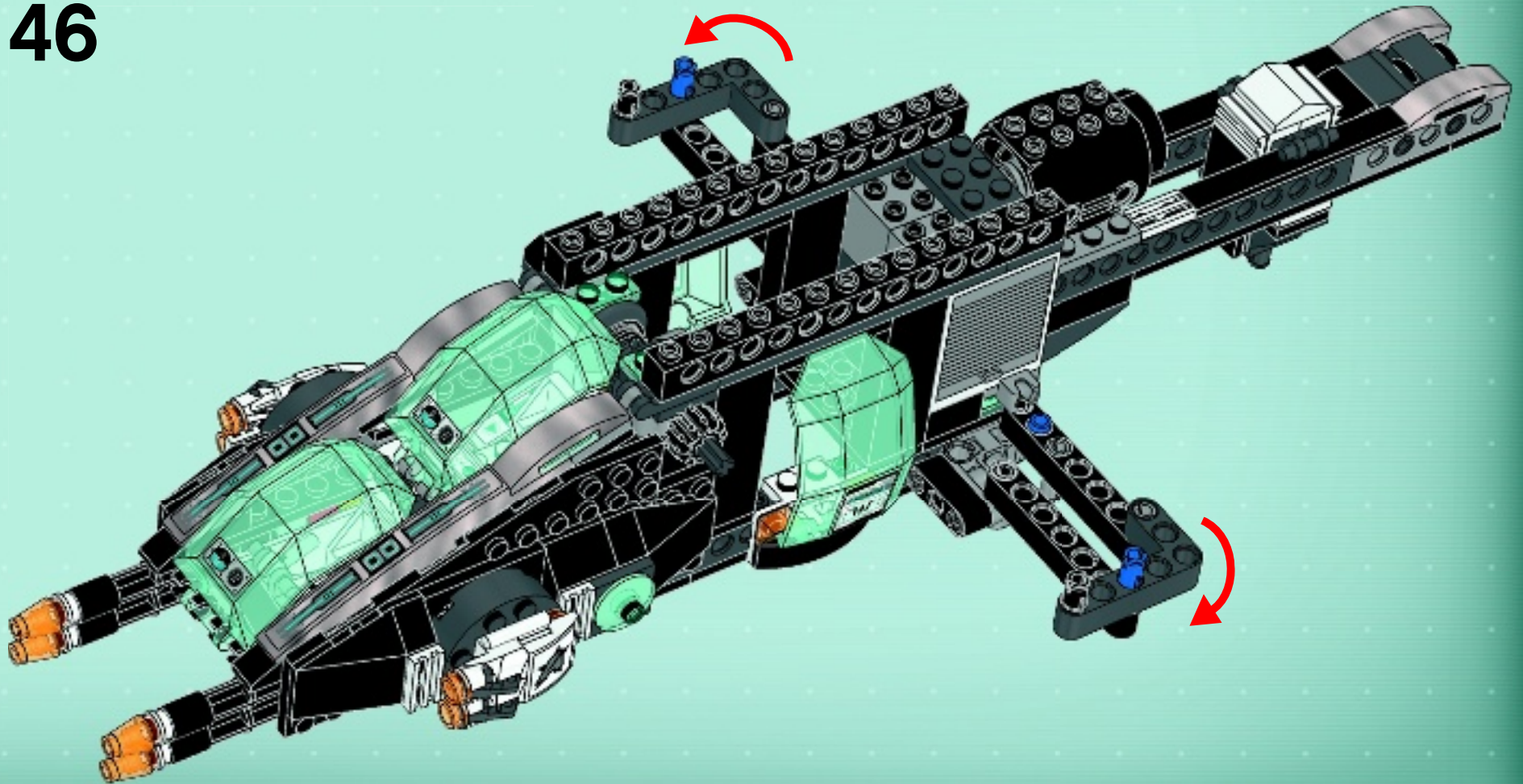

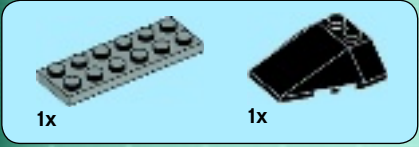

1

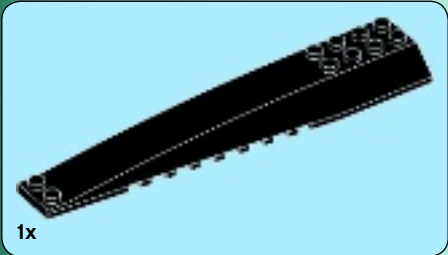
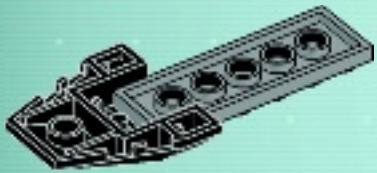

2

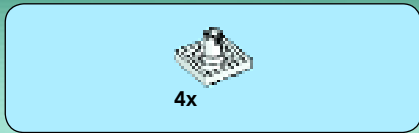
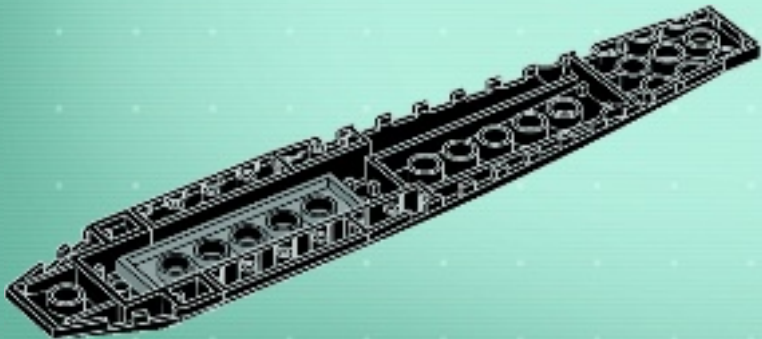

3

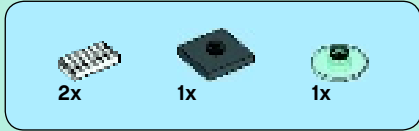
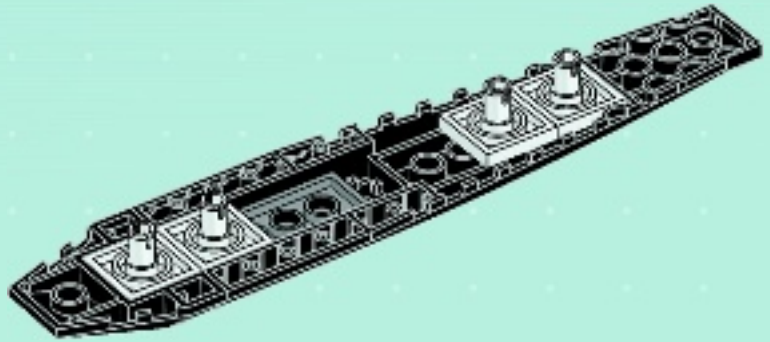

4

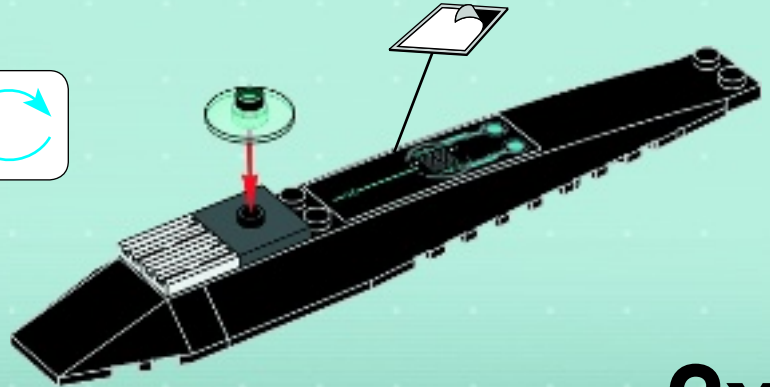
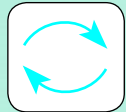

2x

47

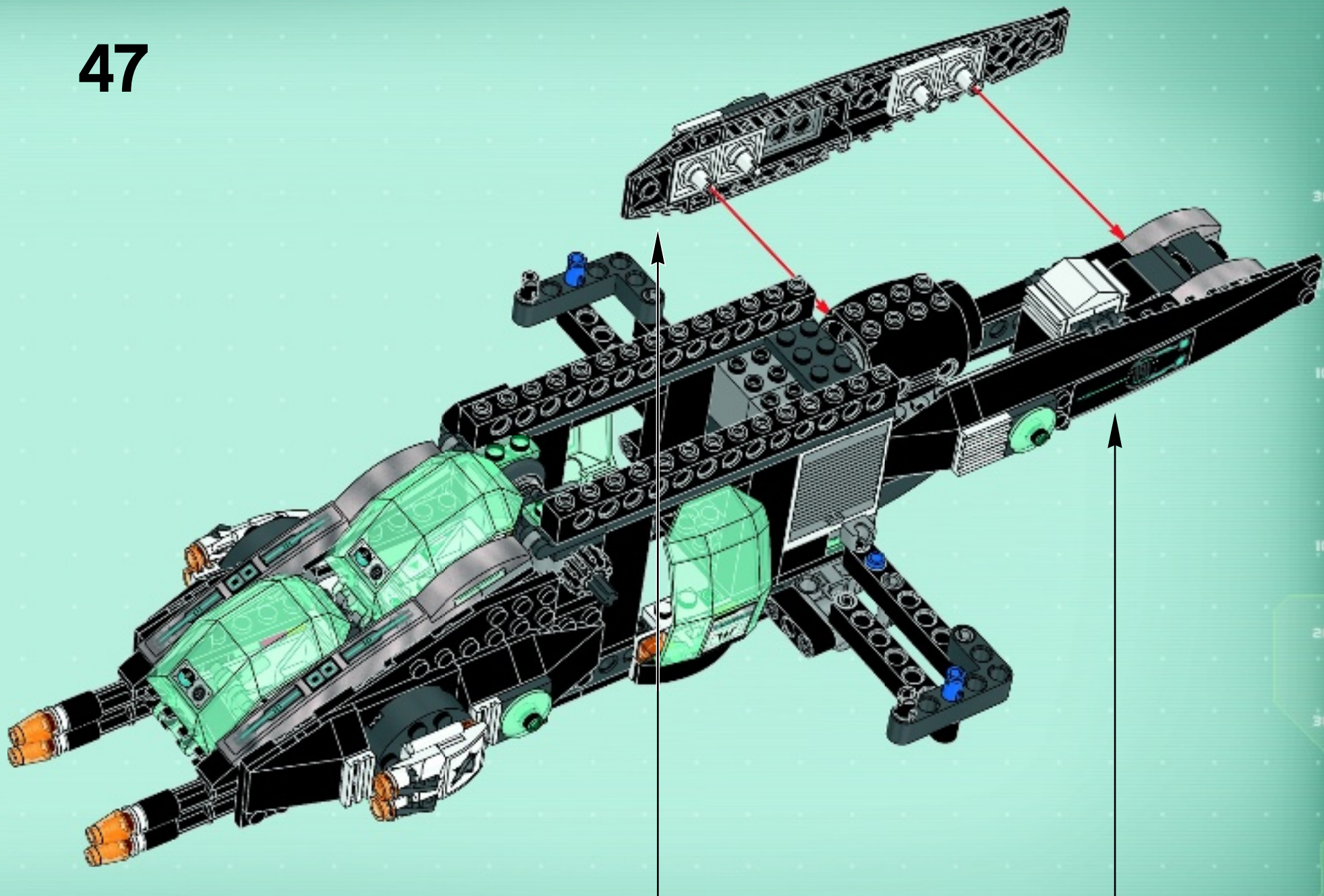

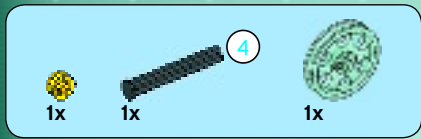
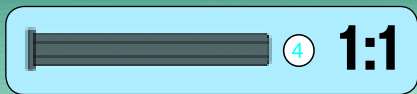

1

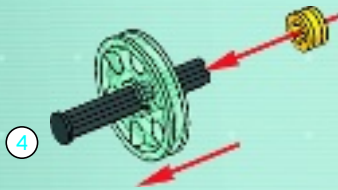

2



3

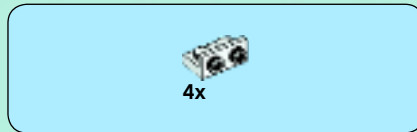
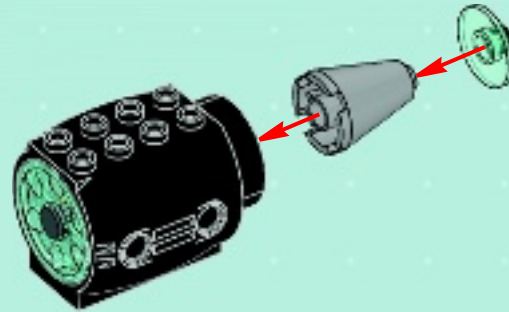

4





5



6

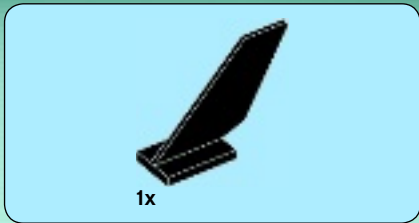
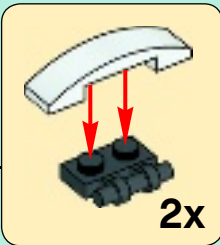

7



2x

48

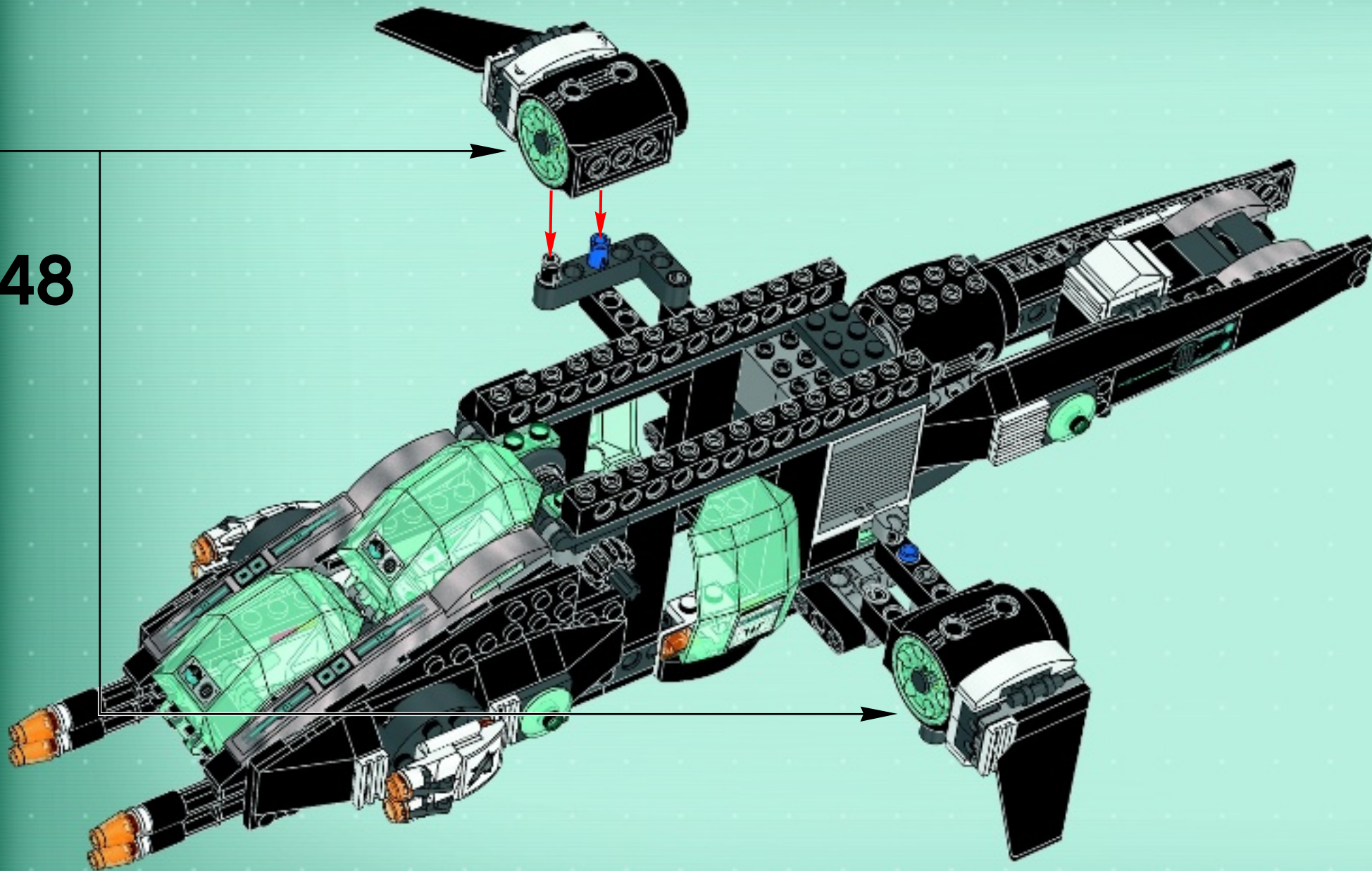

49

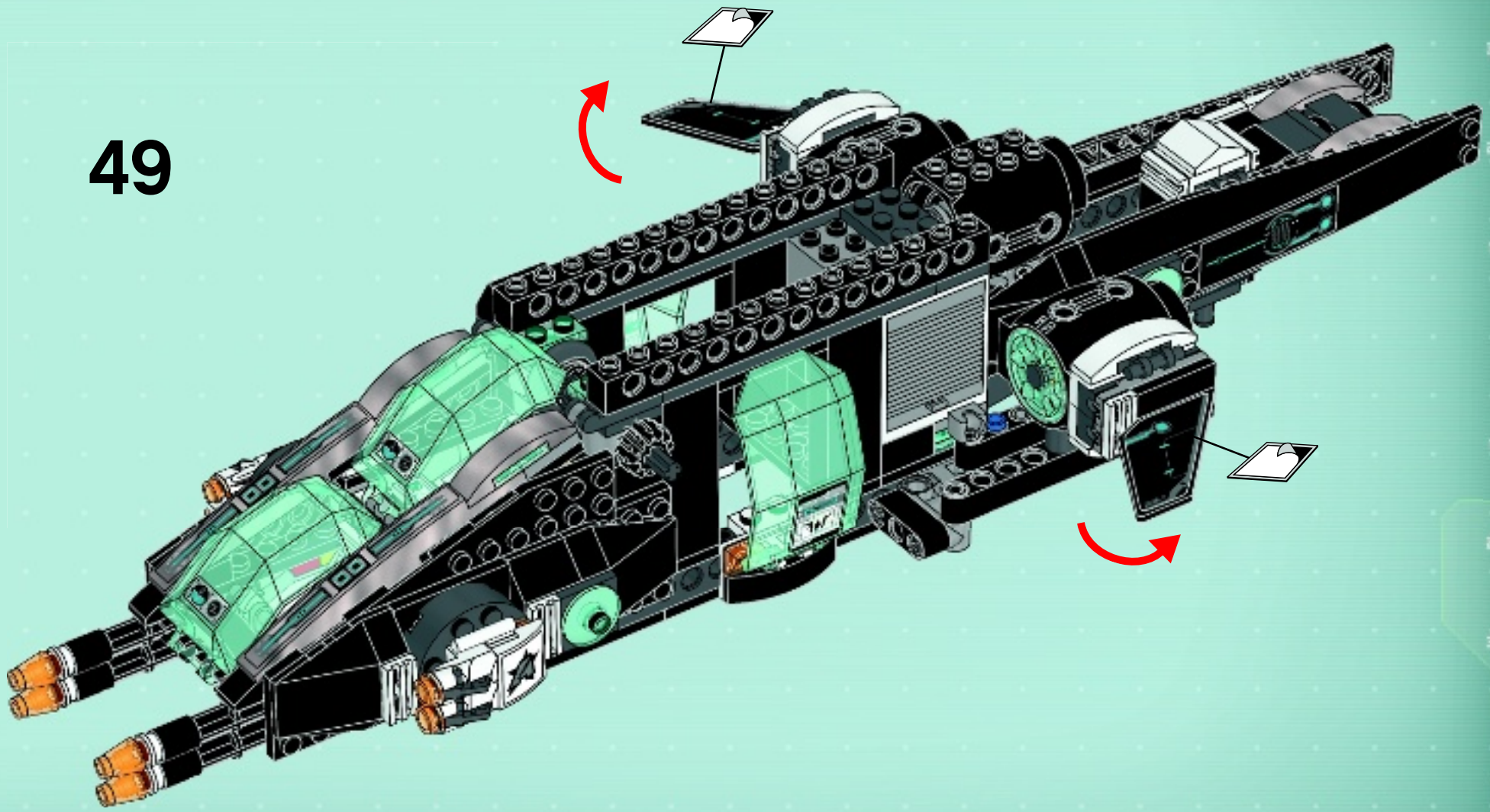

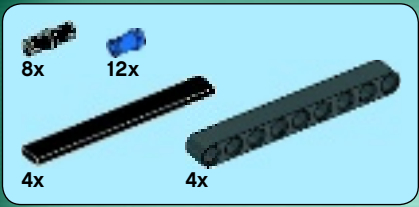

50

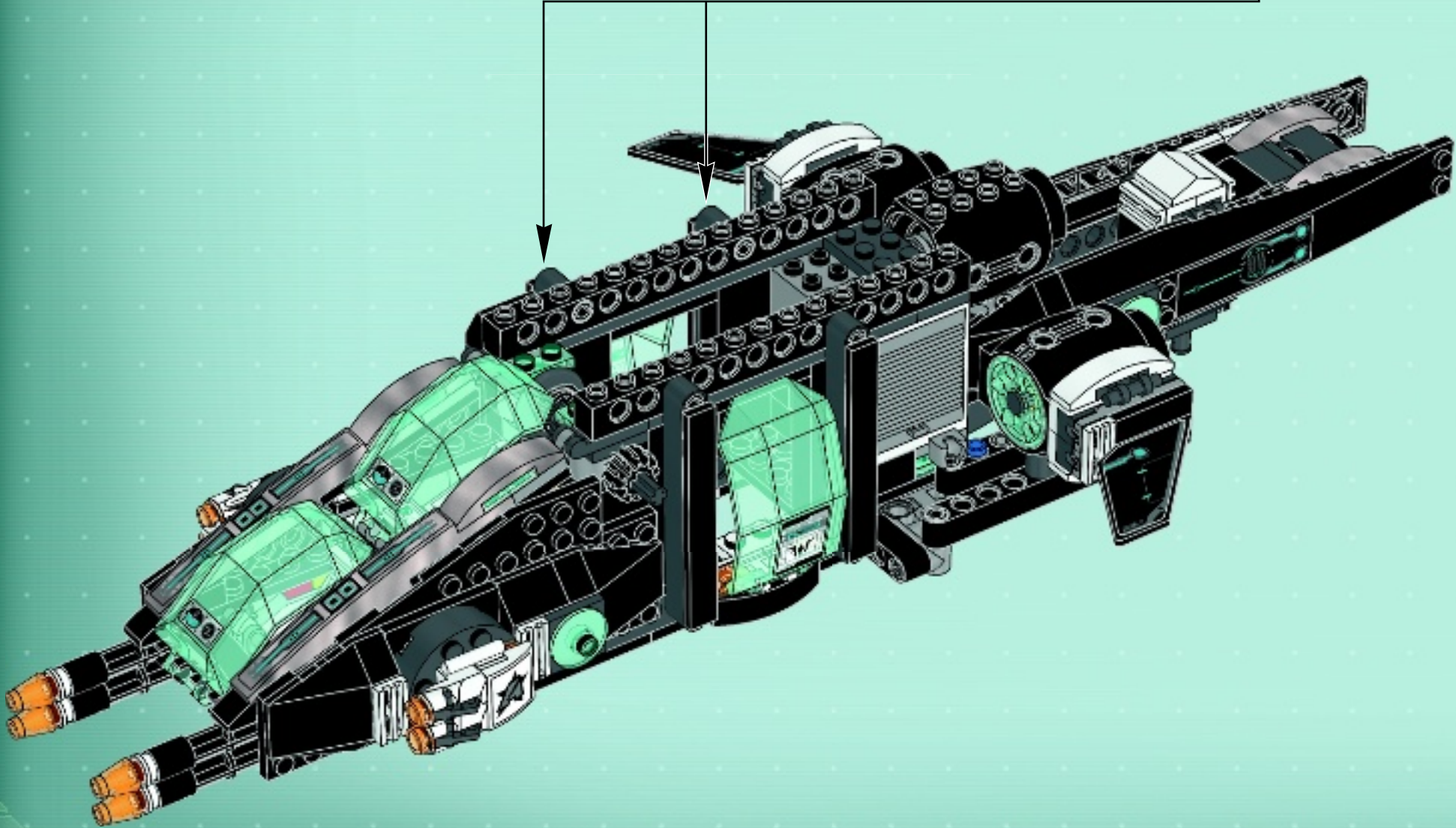
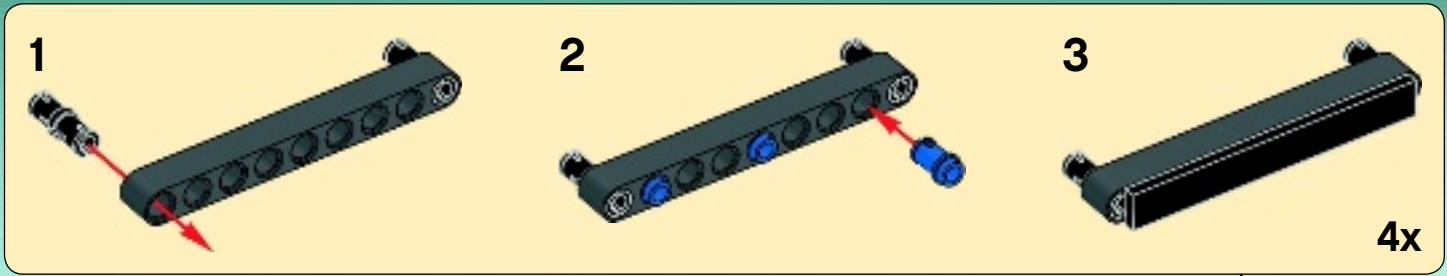



51

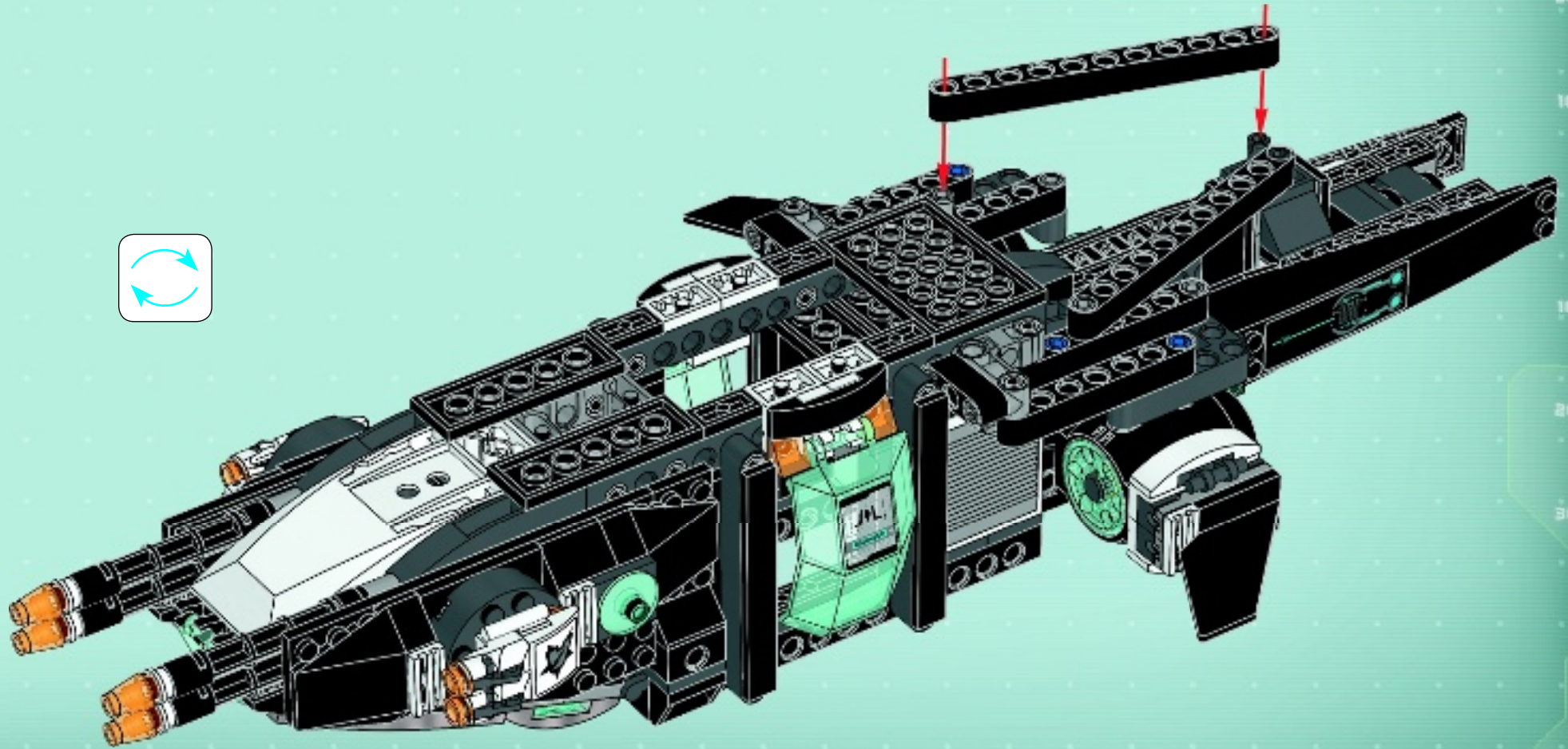
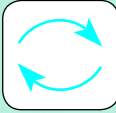



2x



2x

52

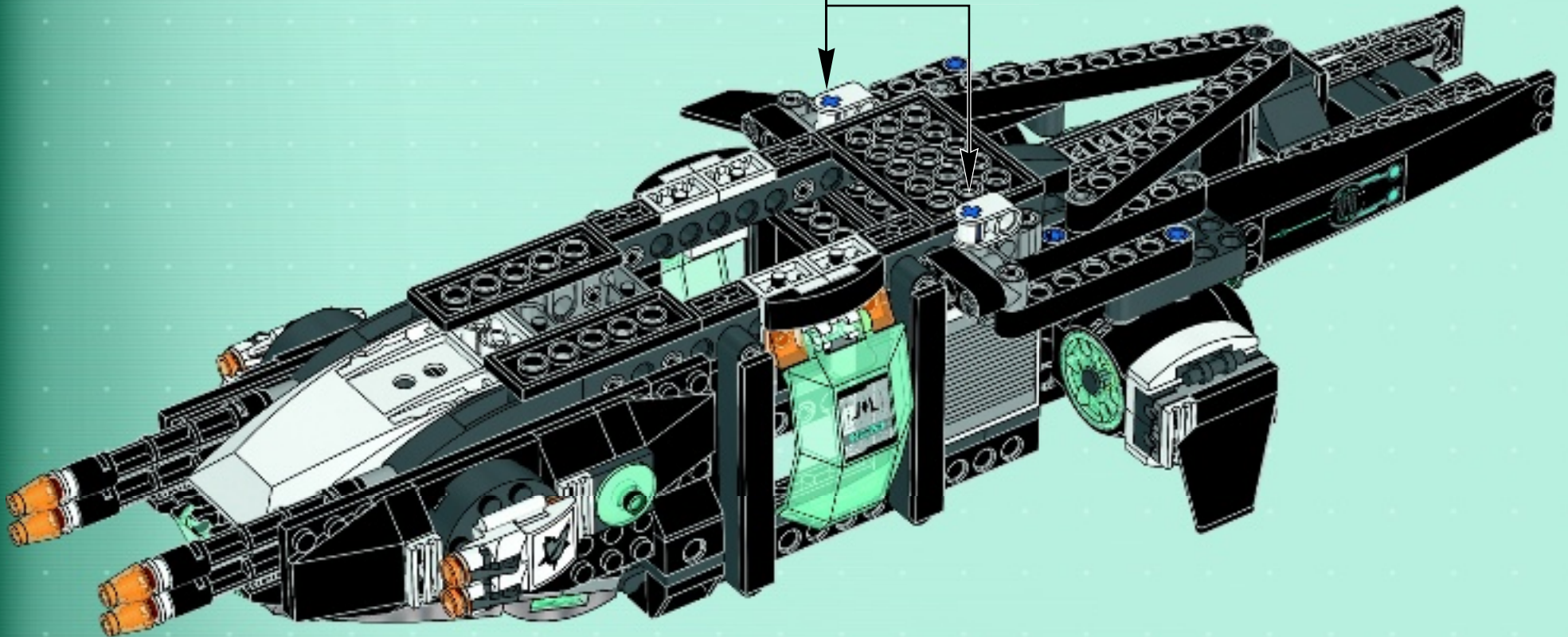
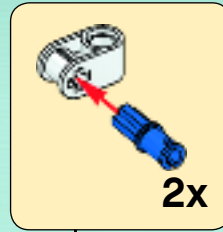



53

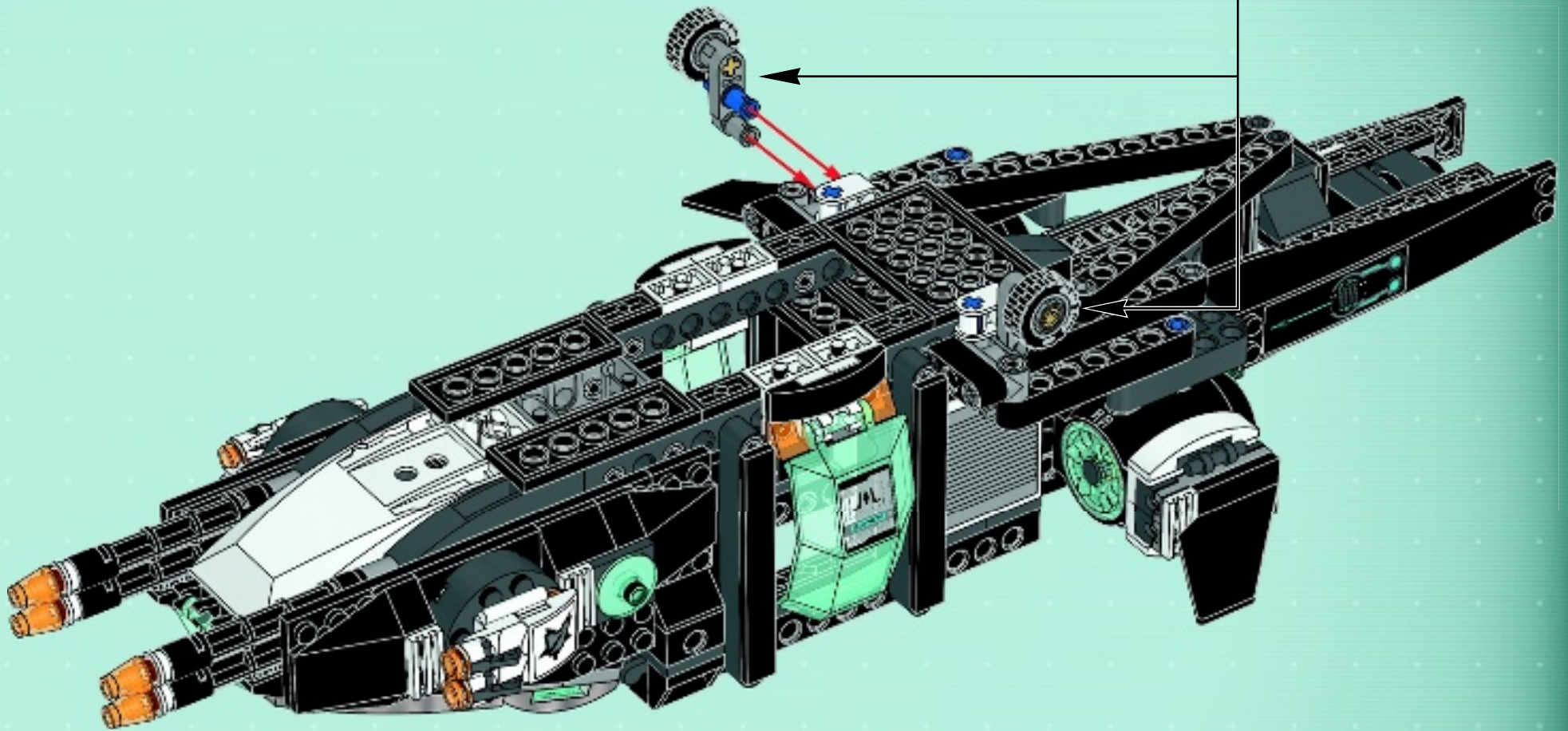
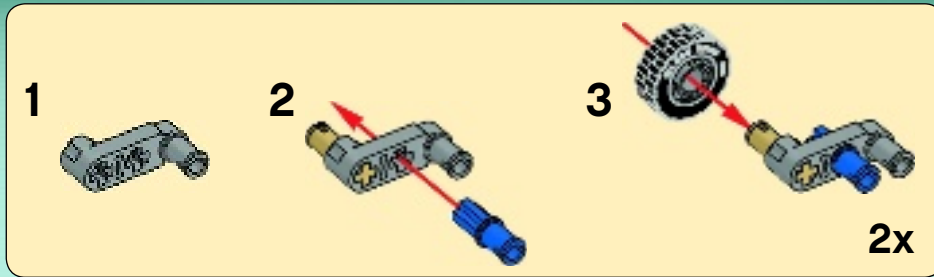





2x

2x

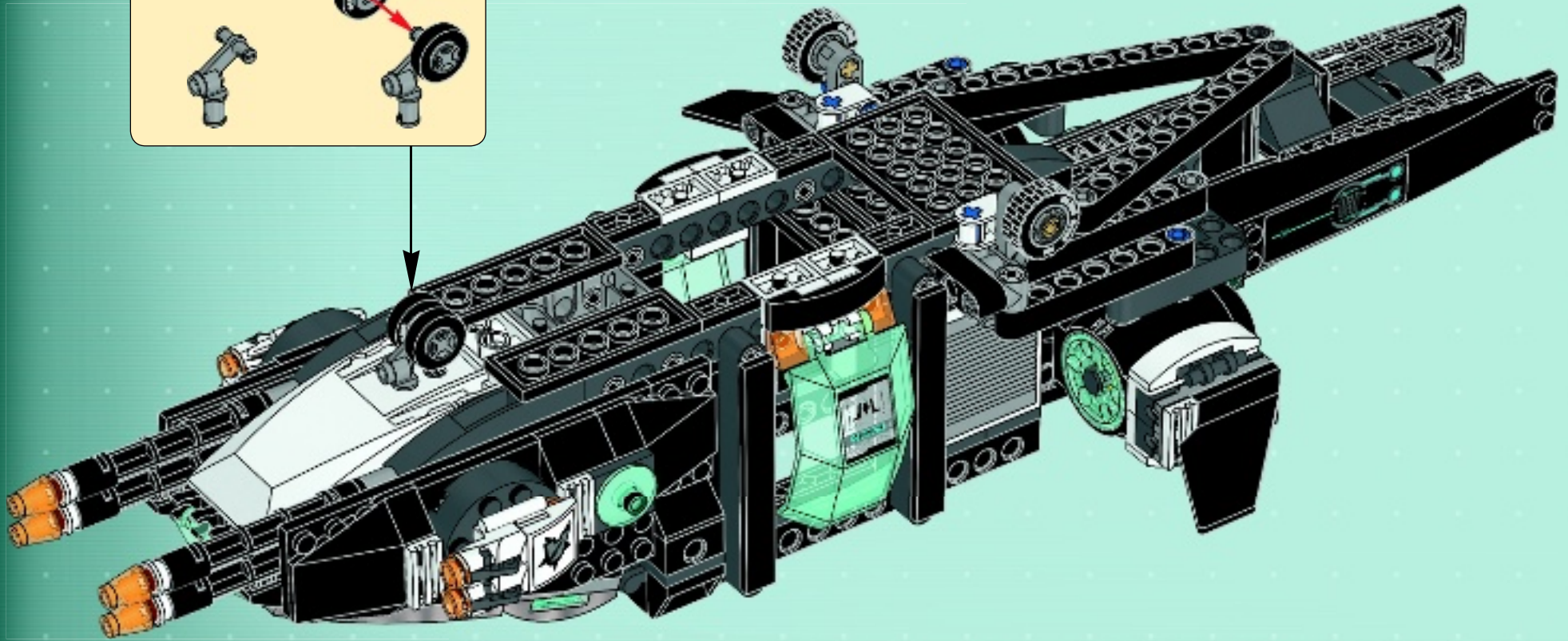
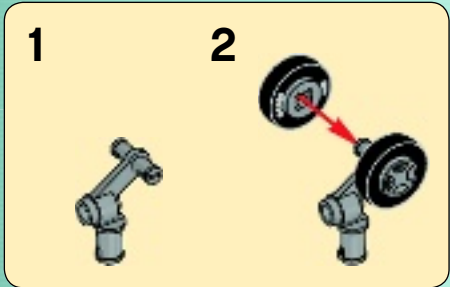
1x

54



- 1x 
- 2x 
- 1x 

55

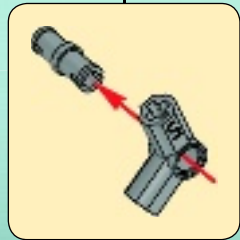
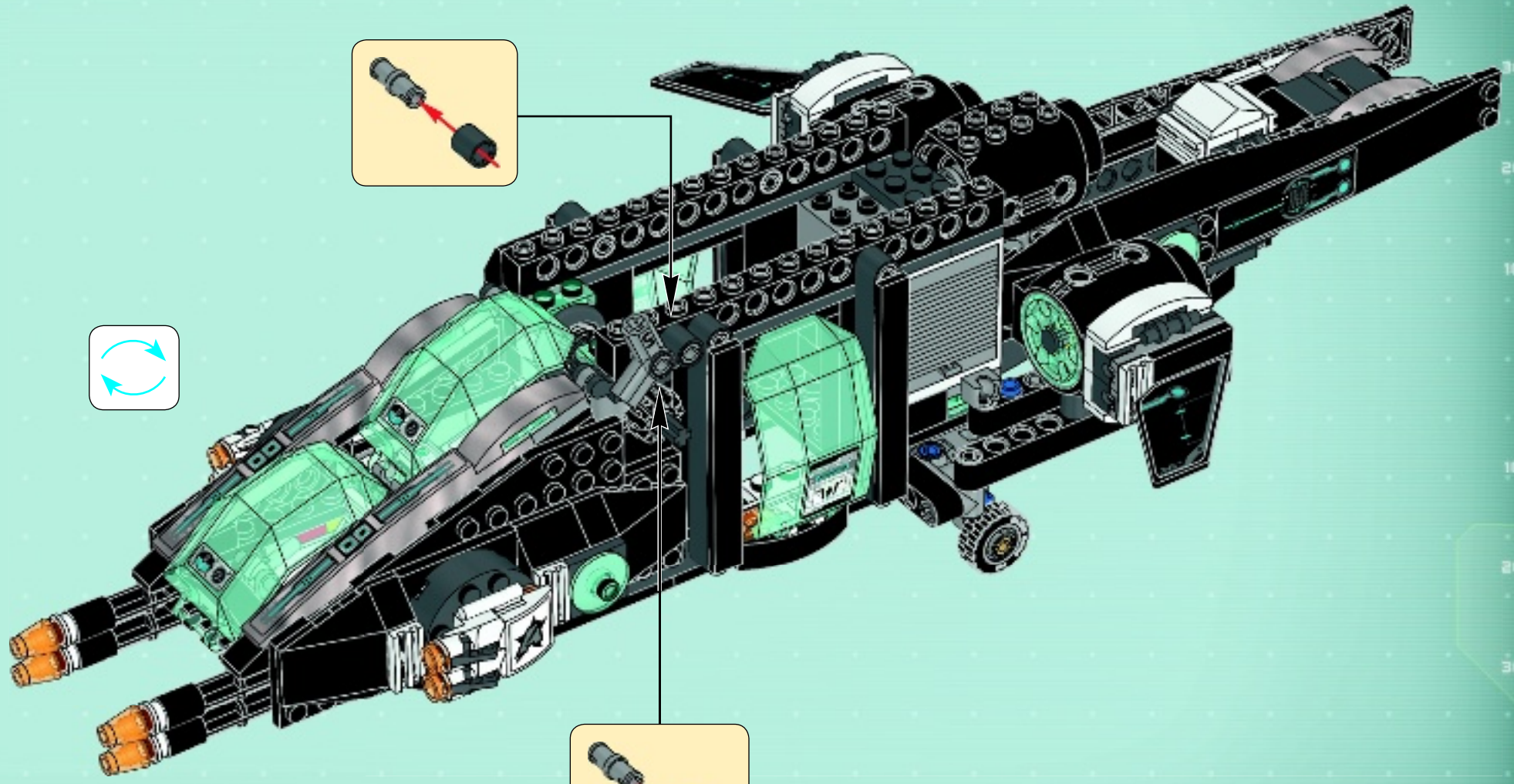
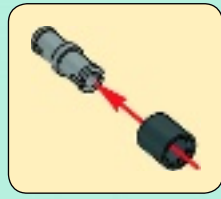
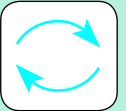

1x

1x

1x

56

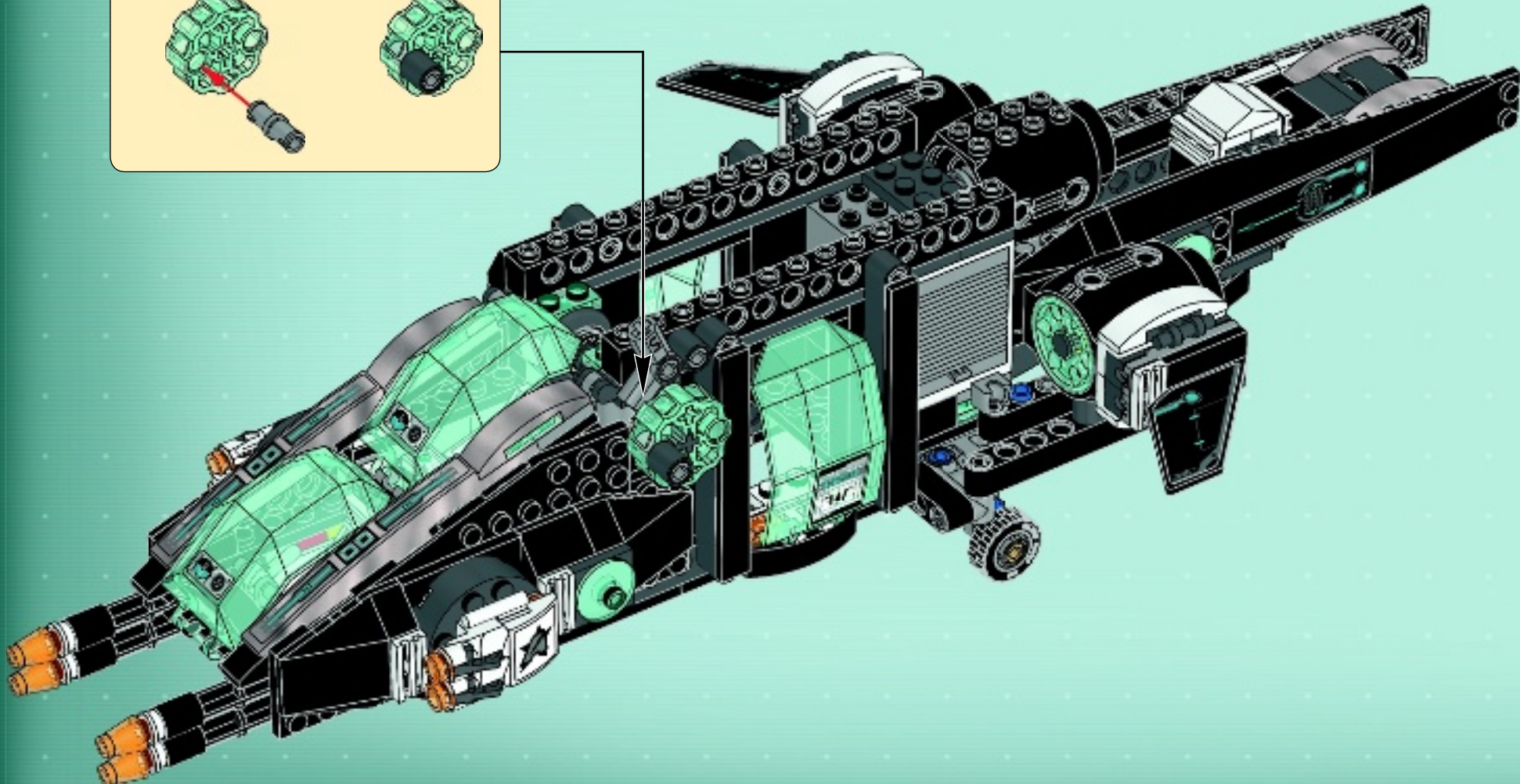
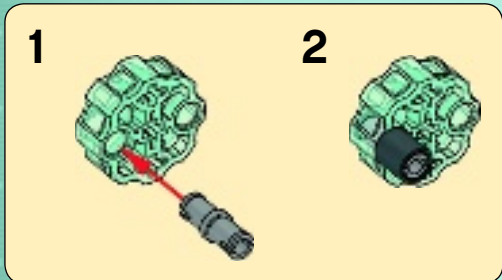

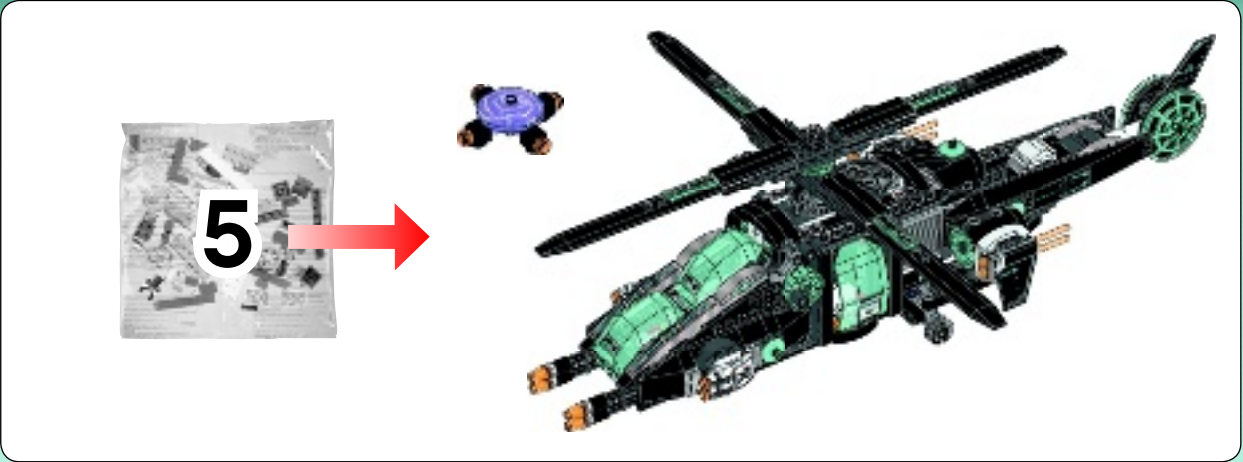

57

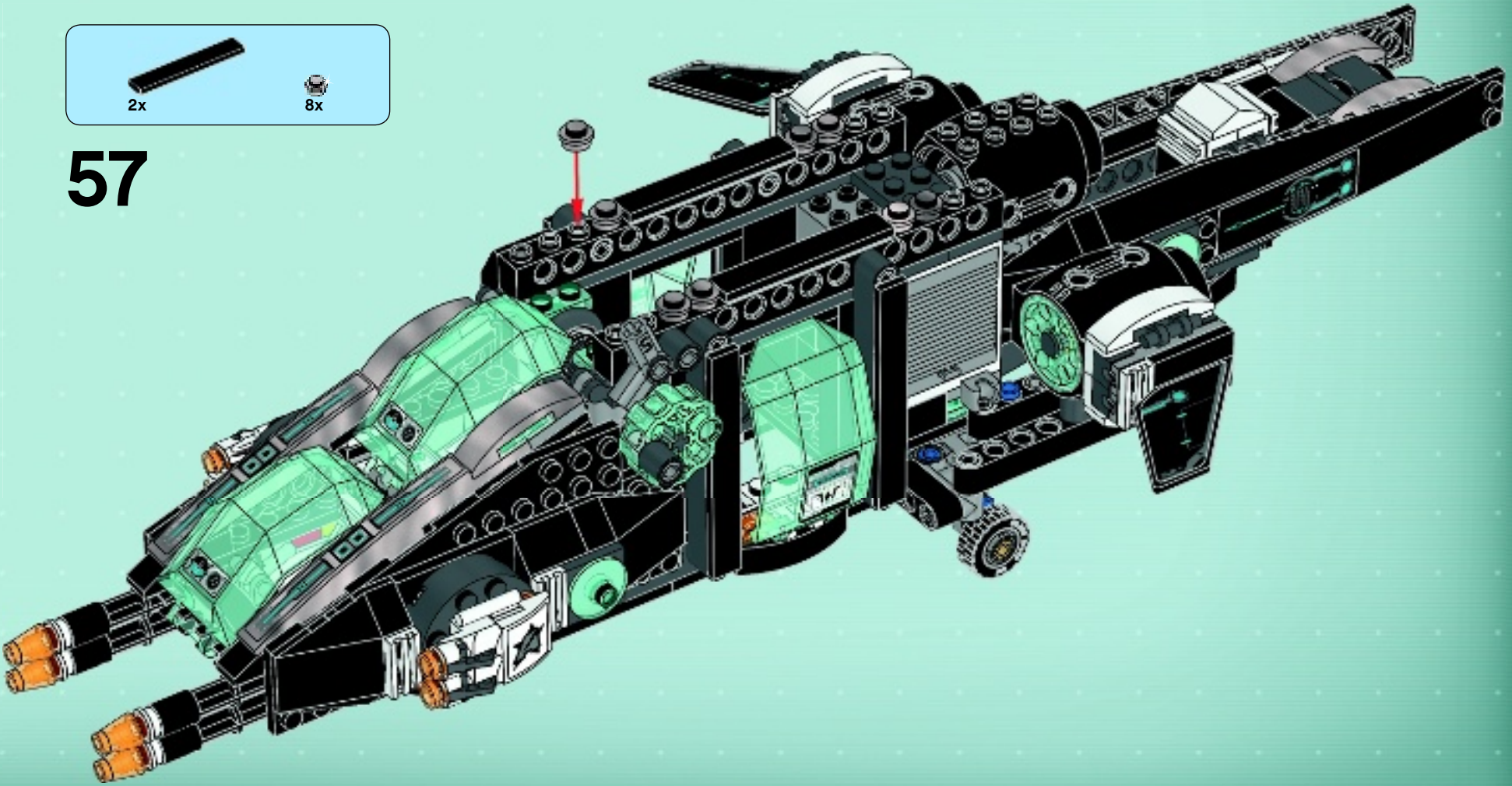



1

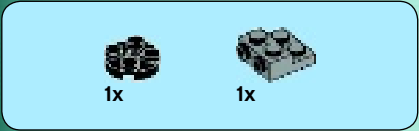

2

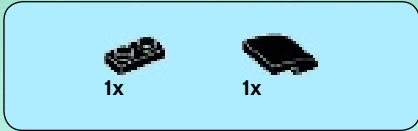

3

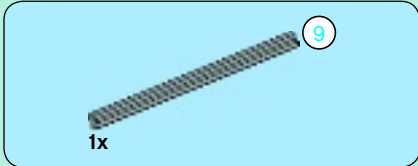
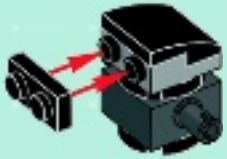

4



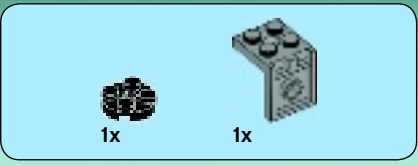

5

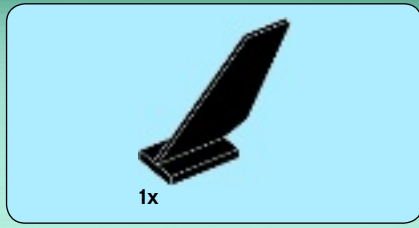
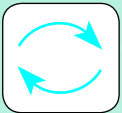

6

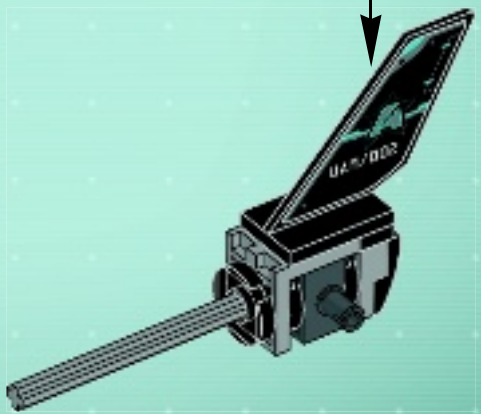
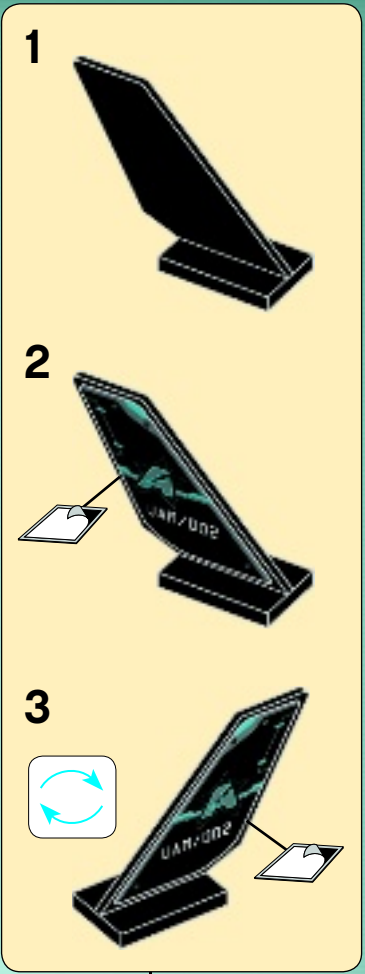



7

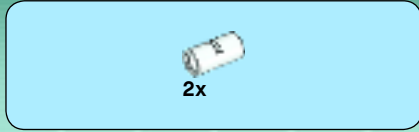
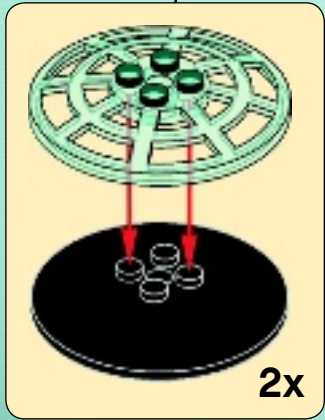
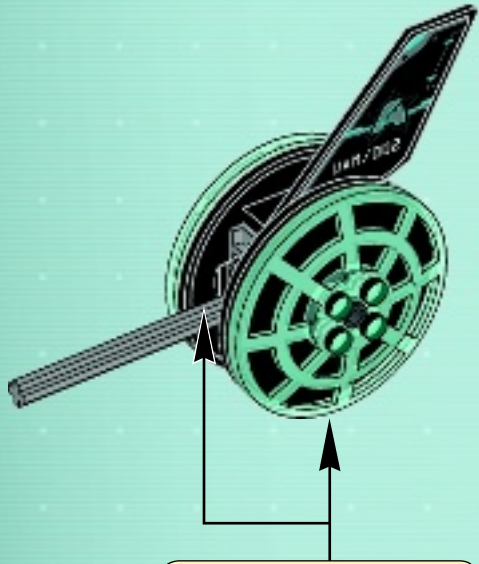

8

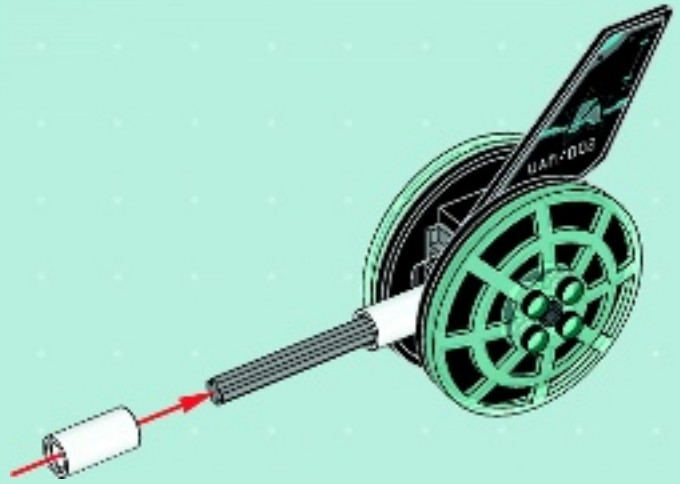

58

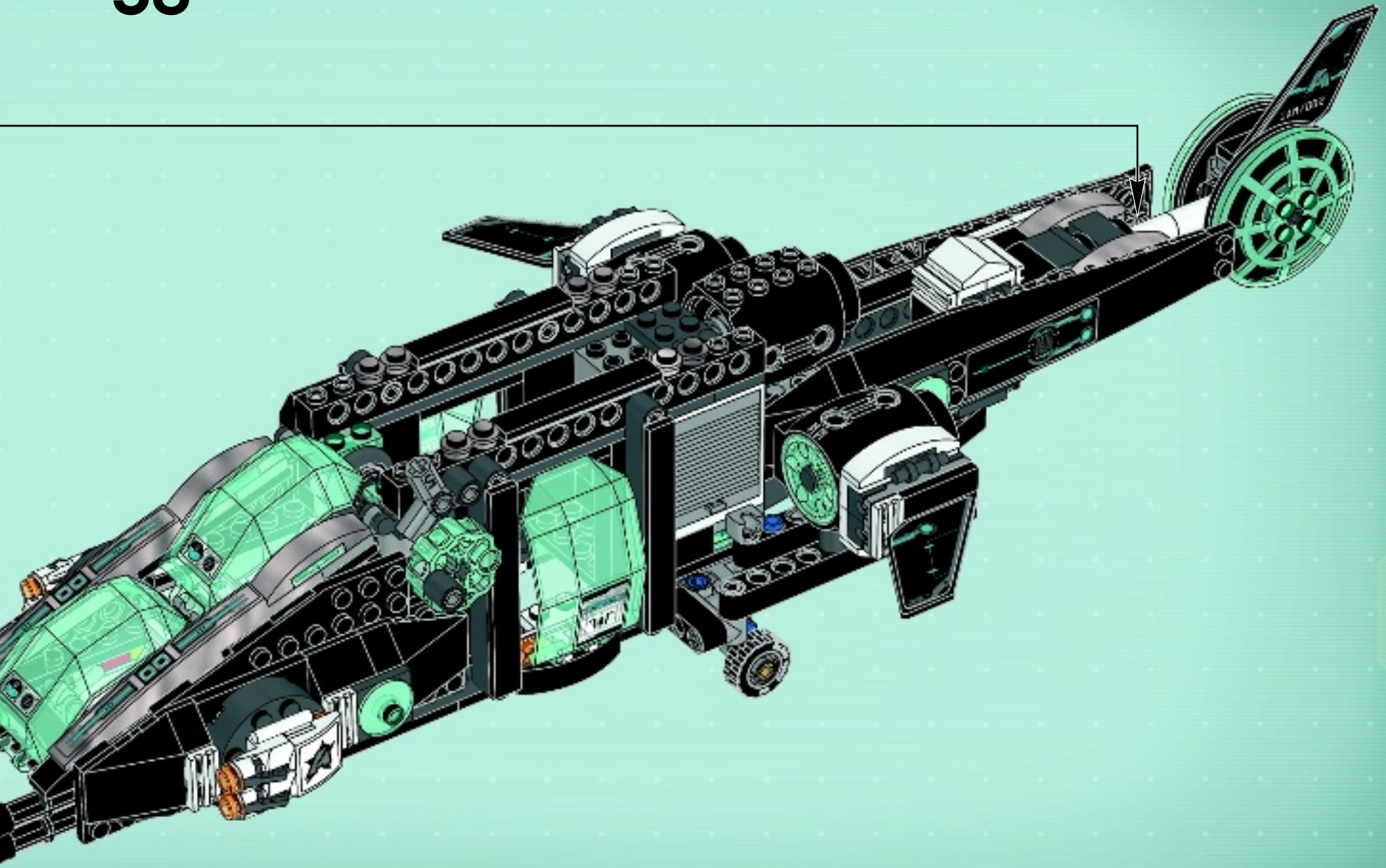

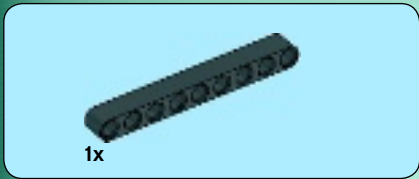
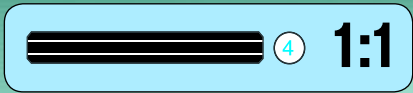

1

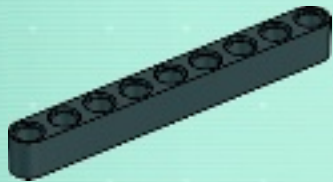

2

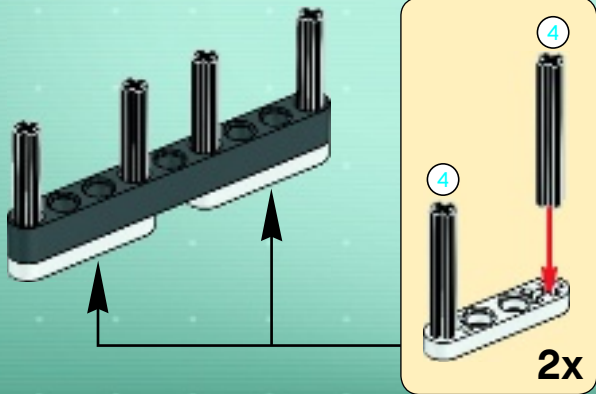

3

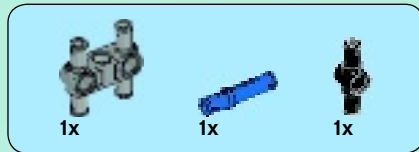
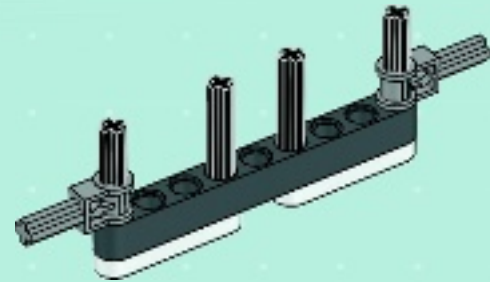

4





5

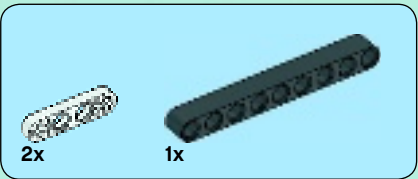
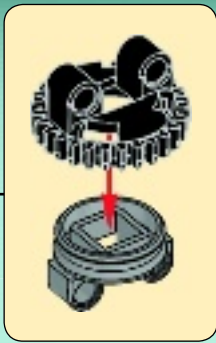
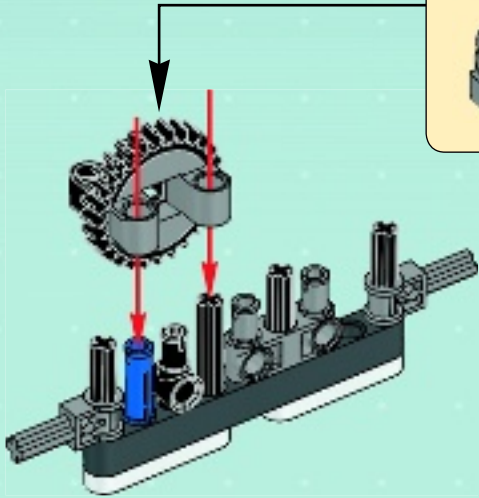

6

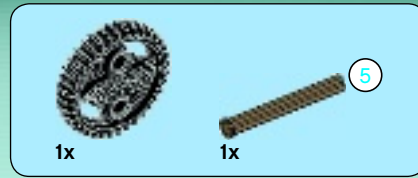
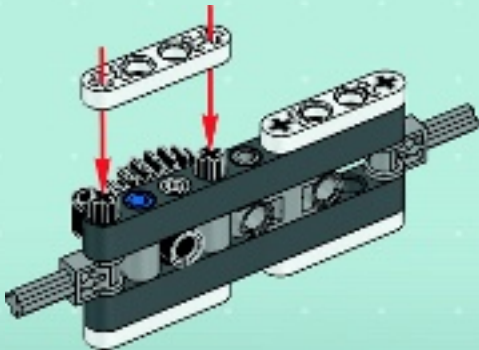

7

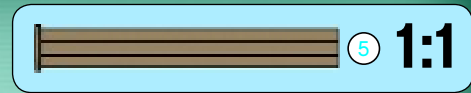
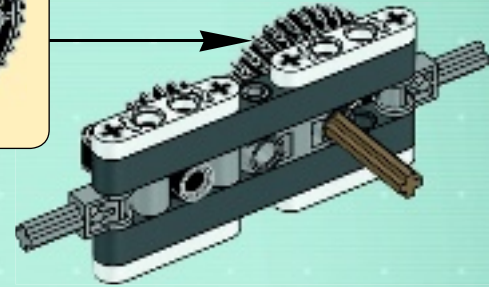
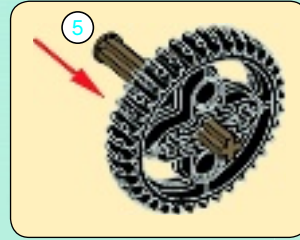

8

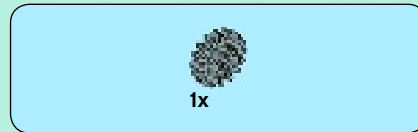

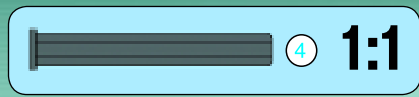
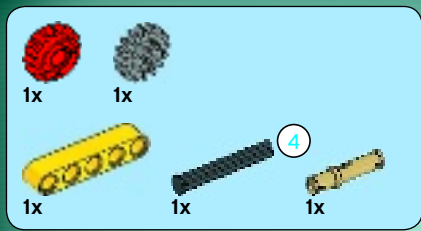

9

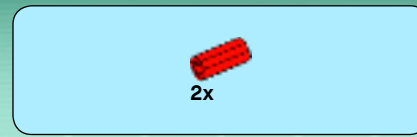
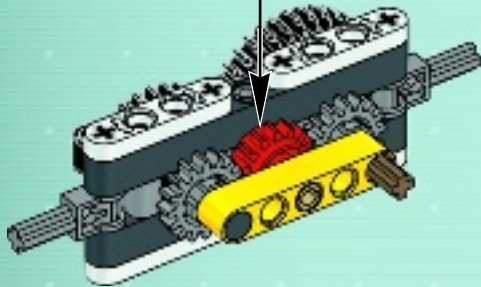
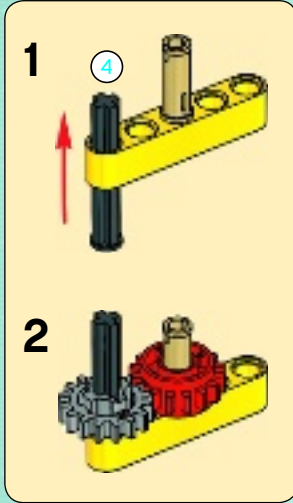

10

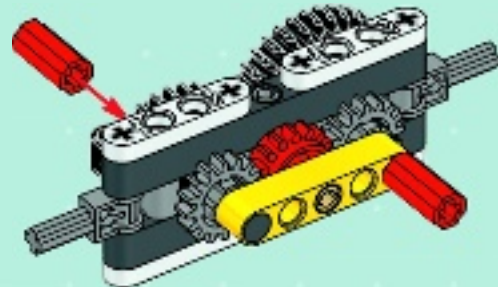



11

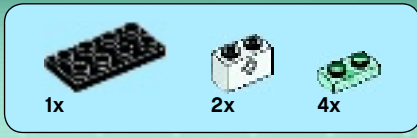
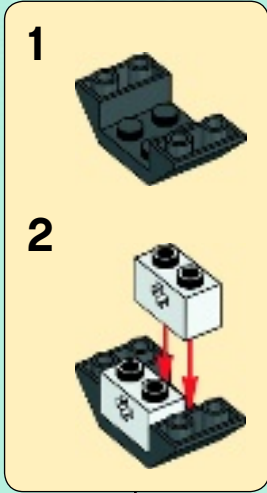

12

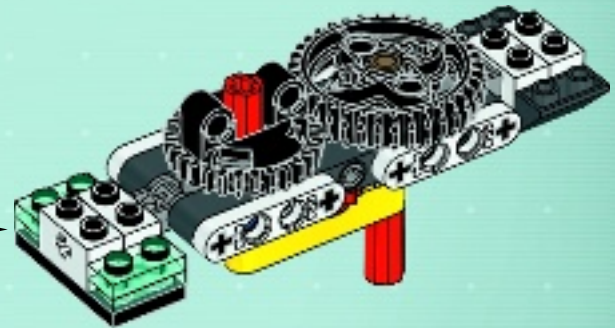
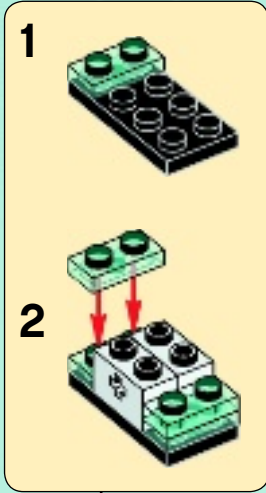

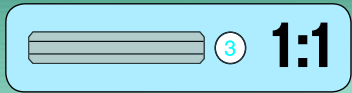
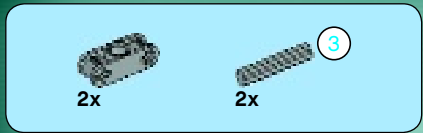

13

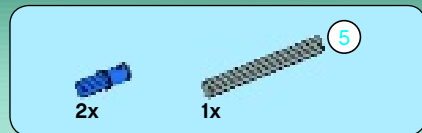
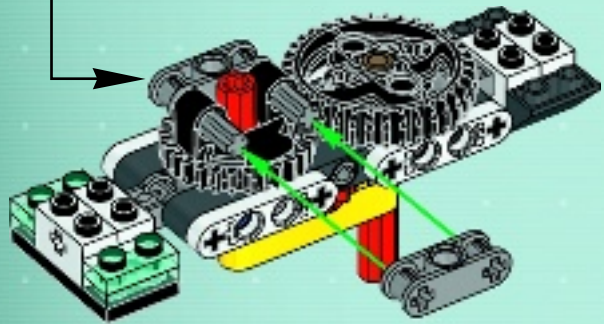
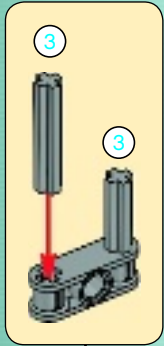

14

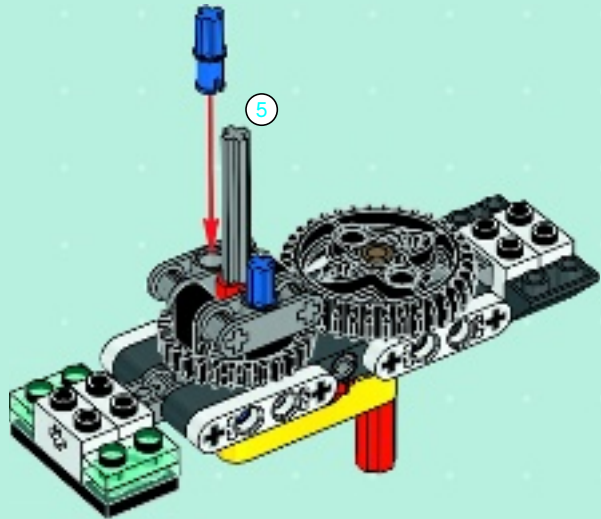

59

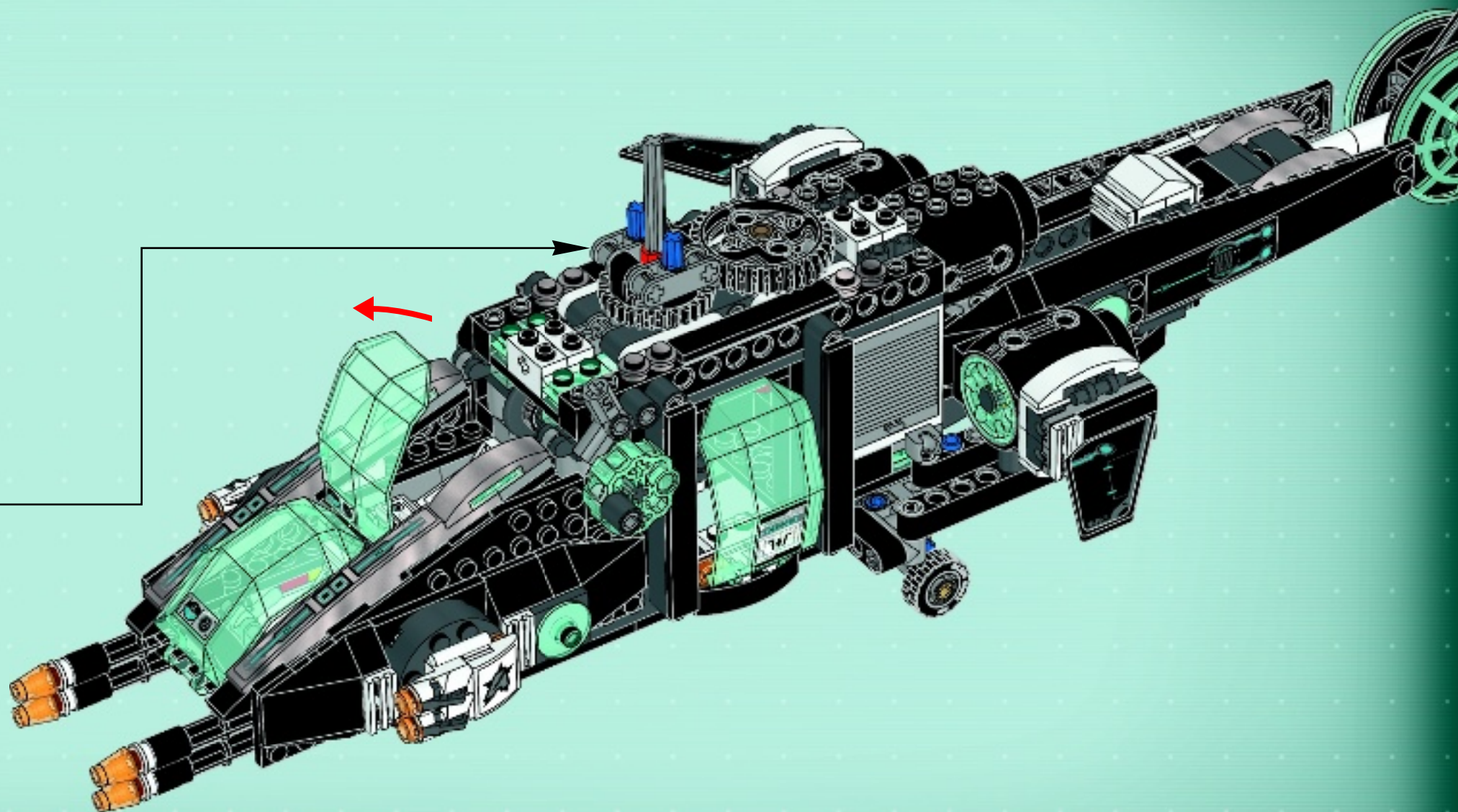



2x



1x



2x

60

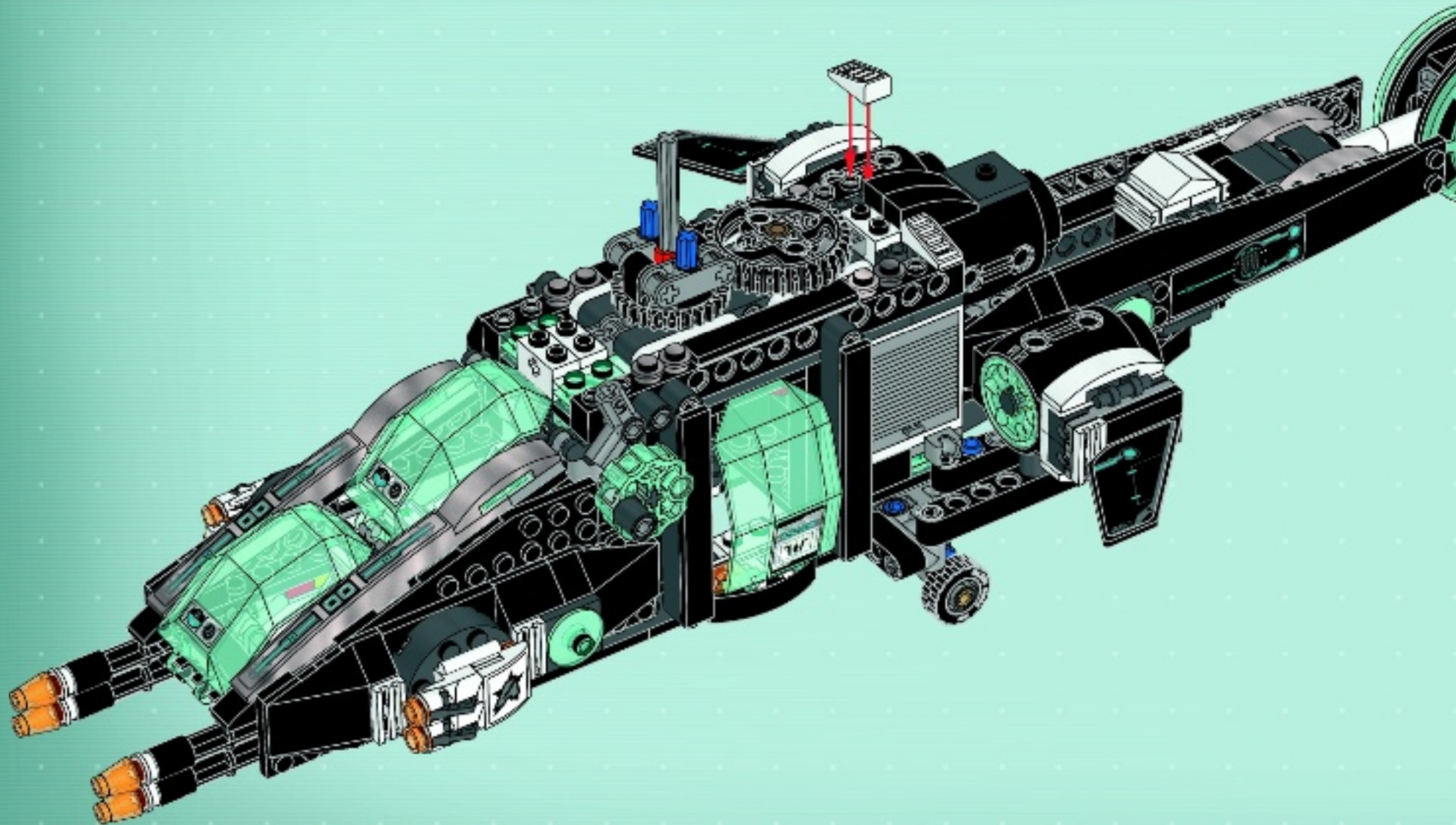



6x



1x

61

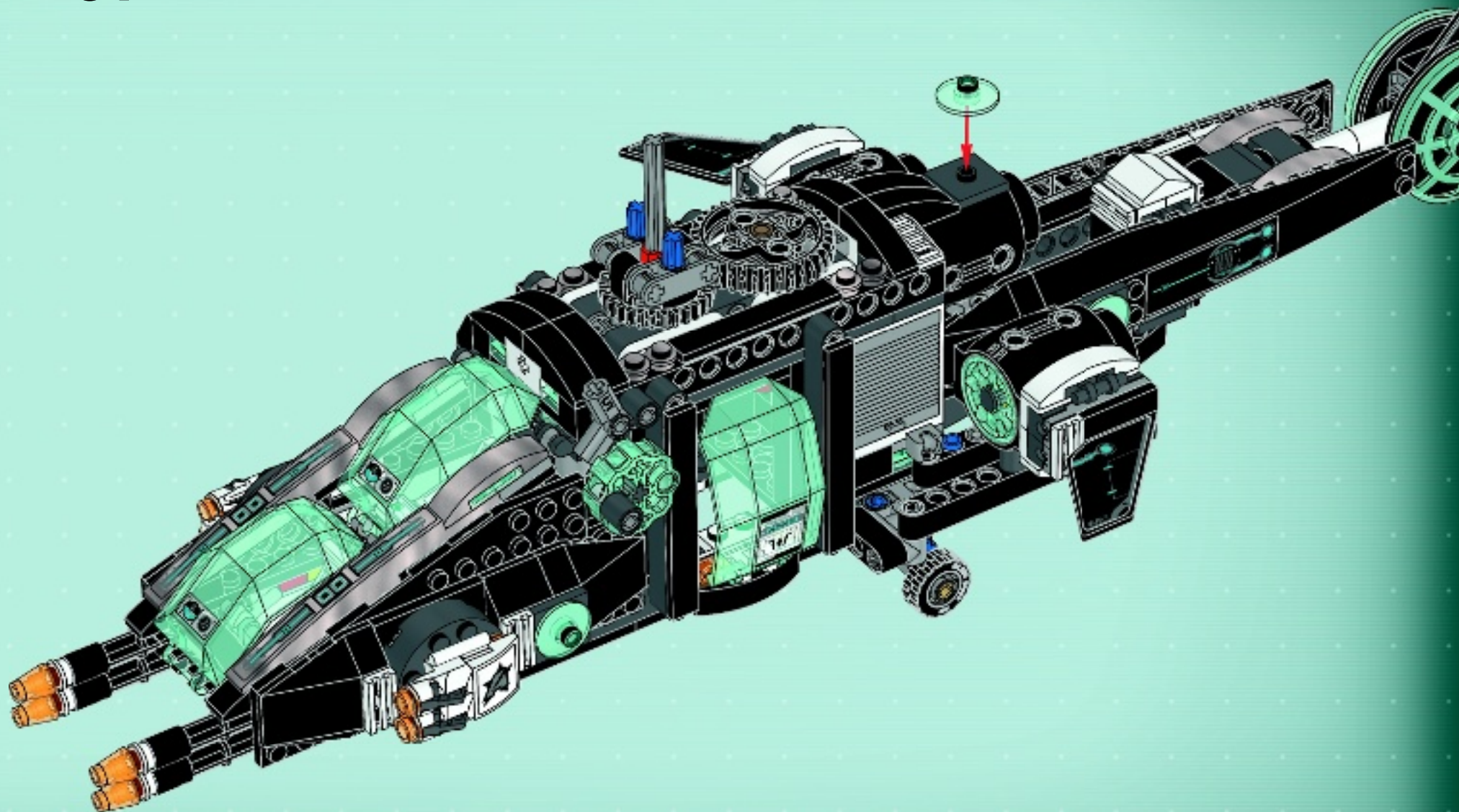

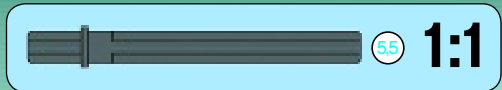
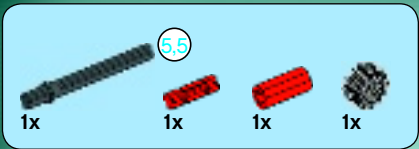

62

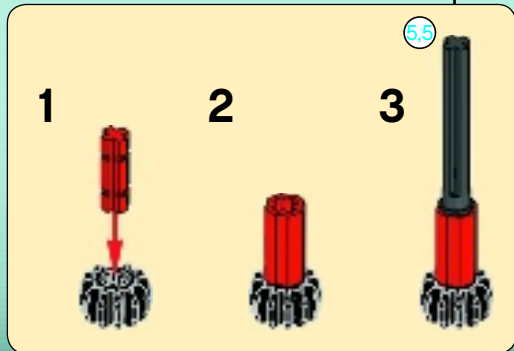
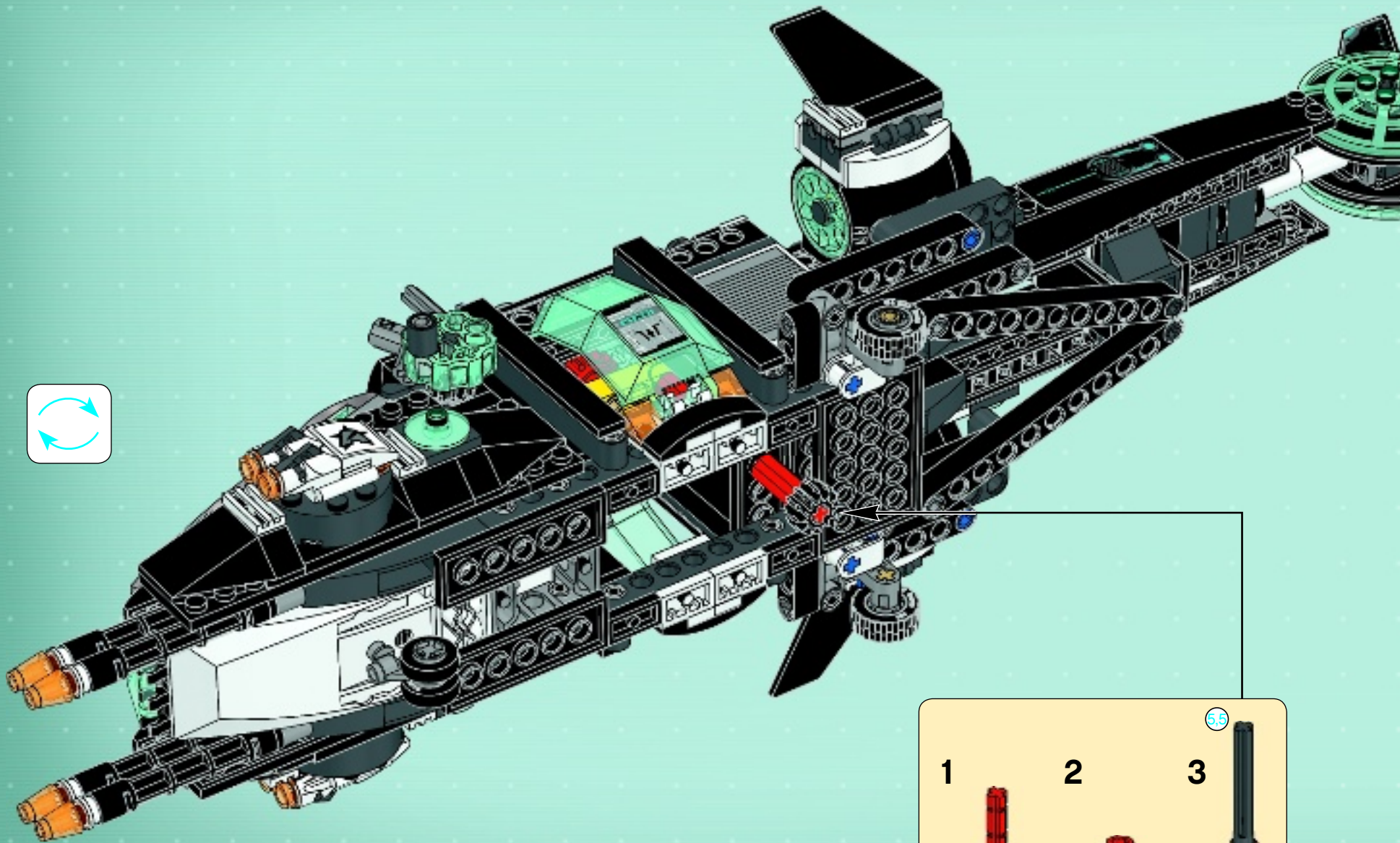
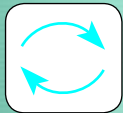

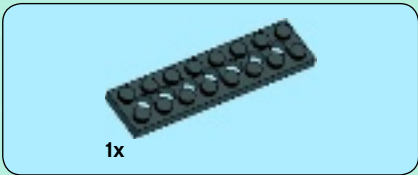
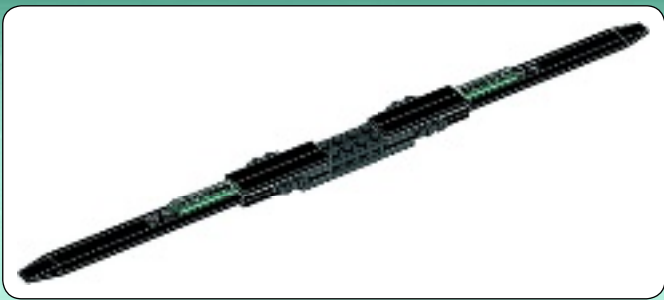

1



2



3

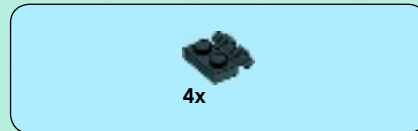

4

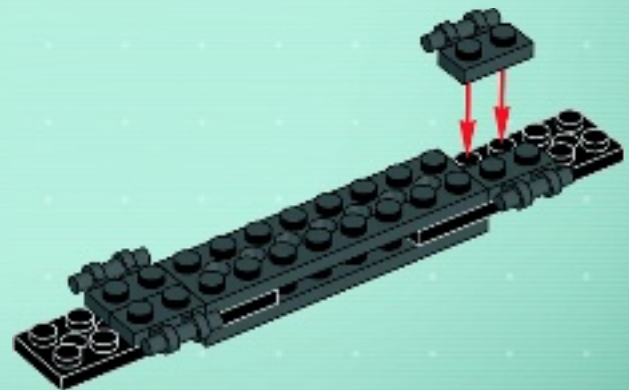

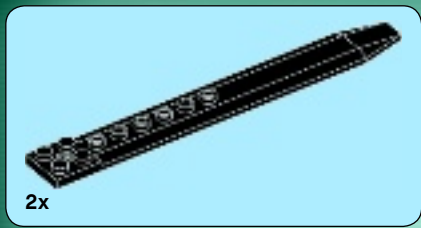

5

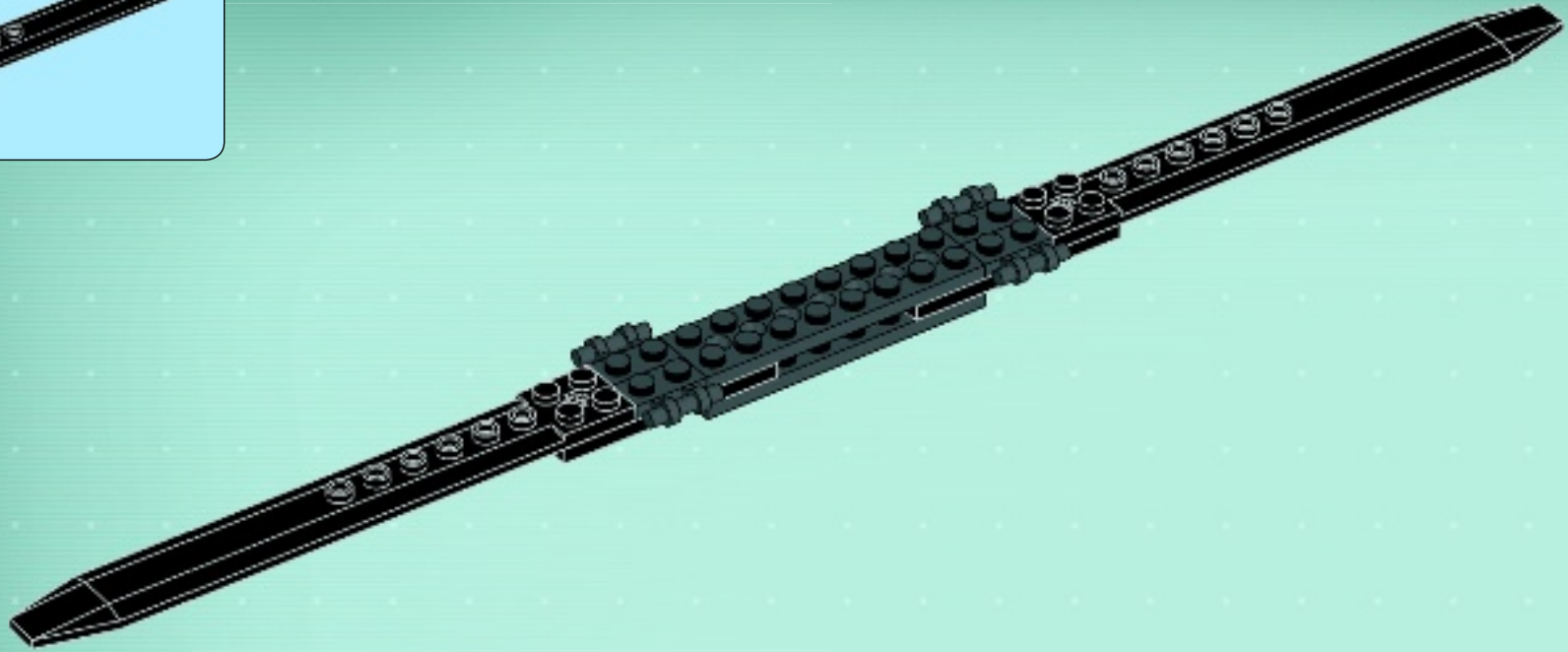

6

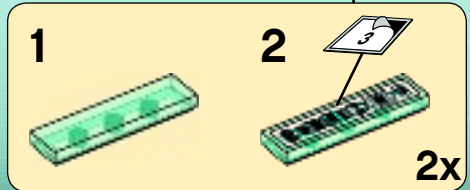
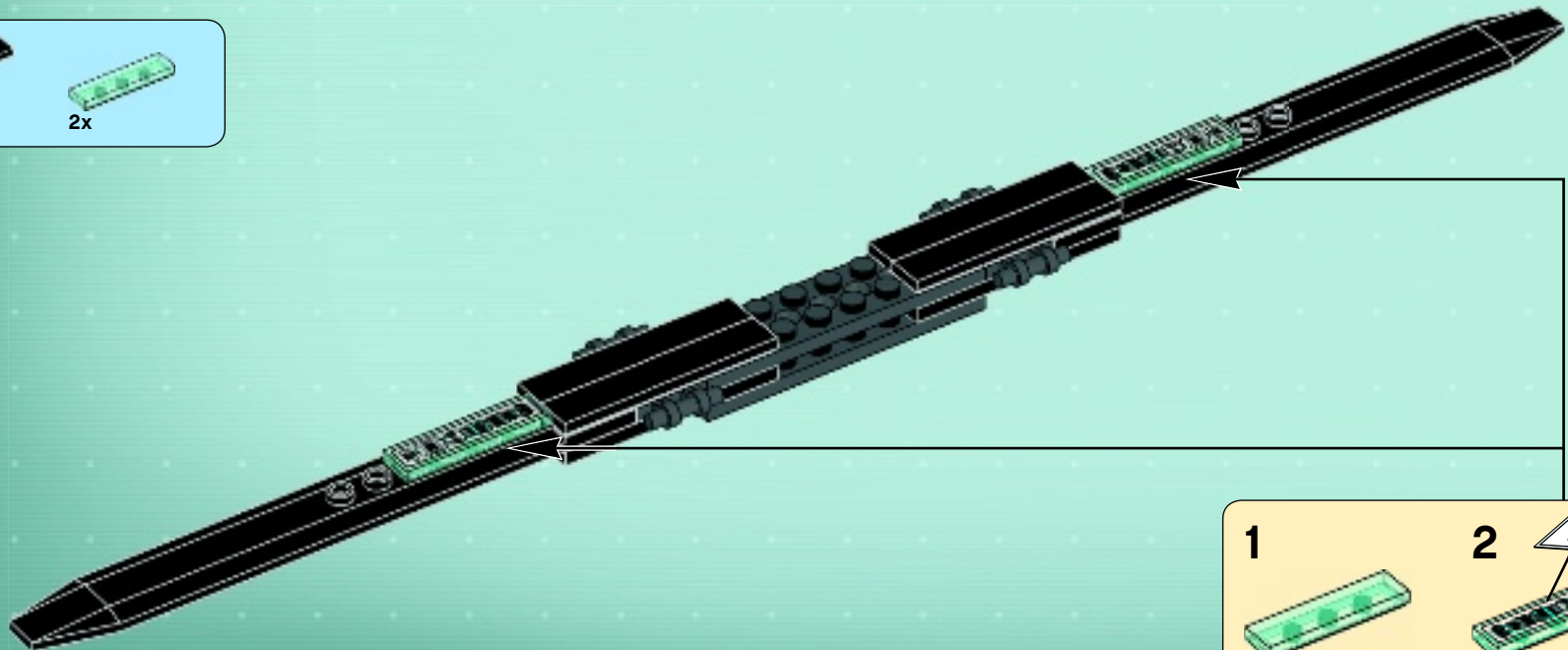

63

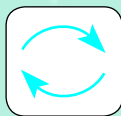



1x

64



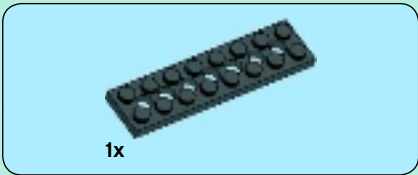
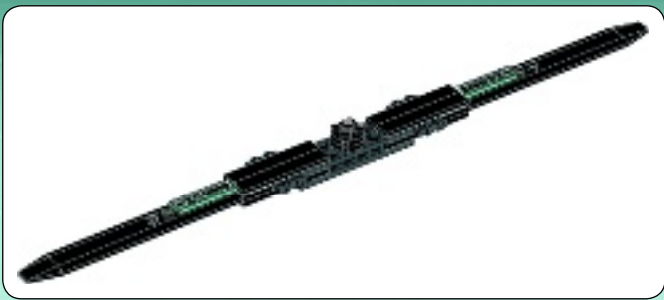

1



2



3



4

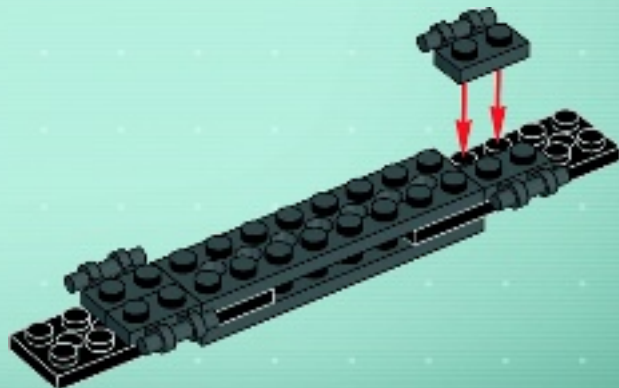

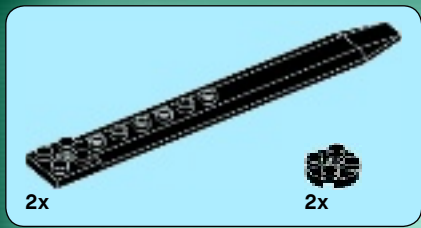

5

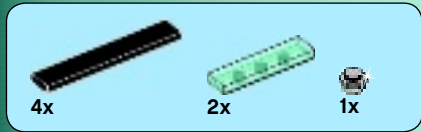
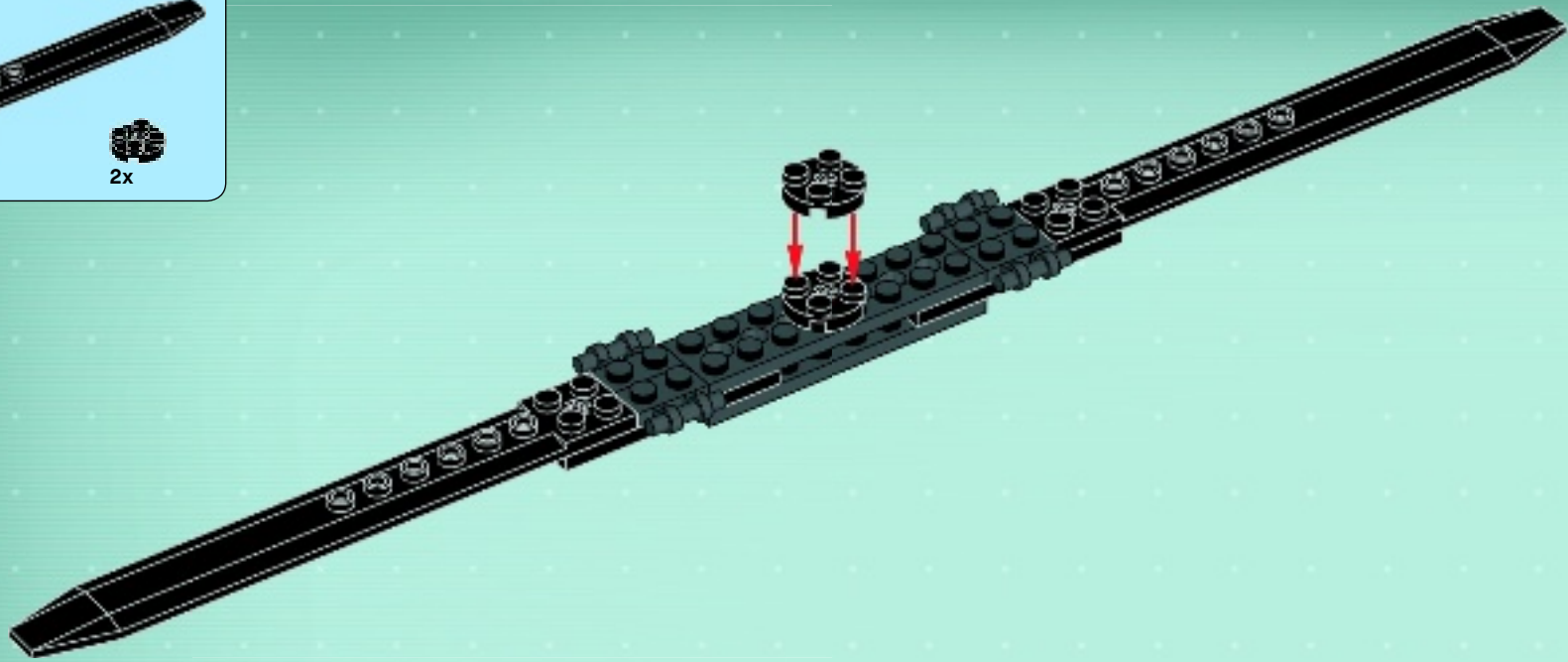

6

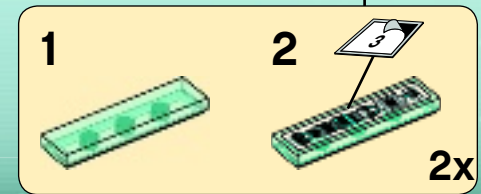
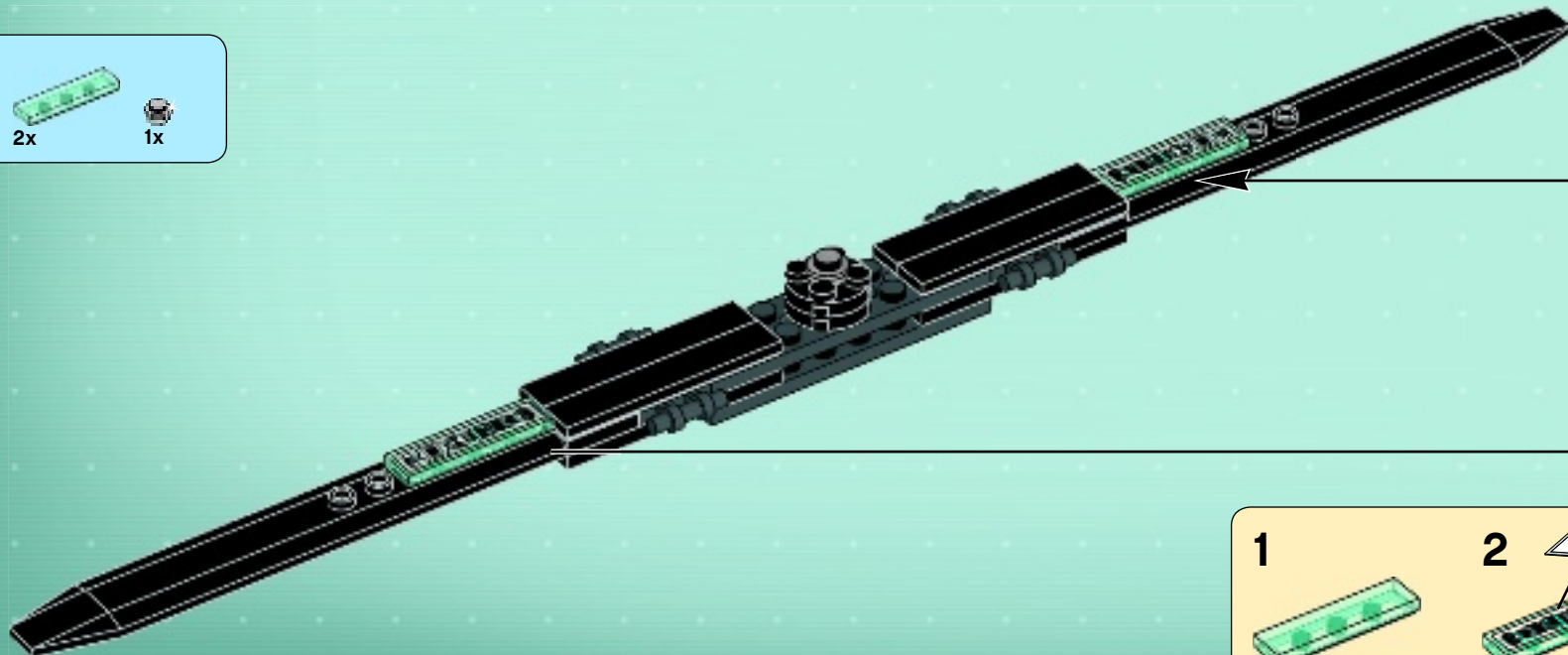

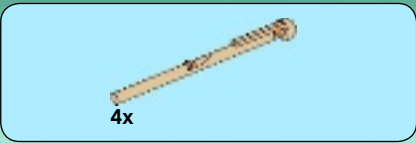

65

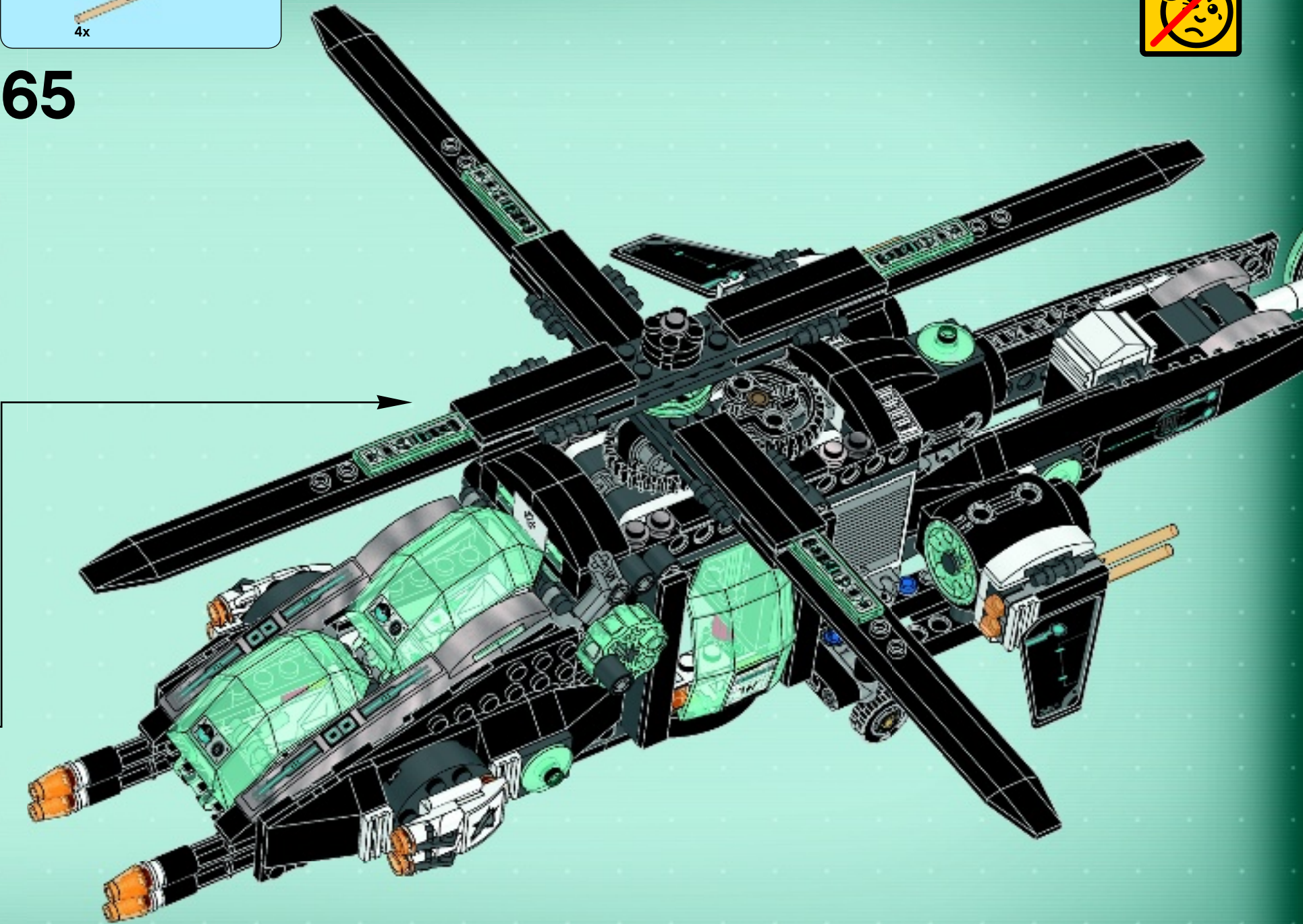



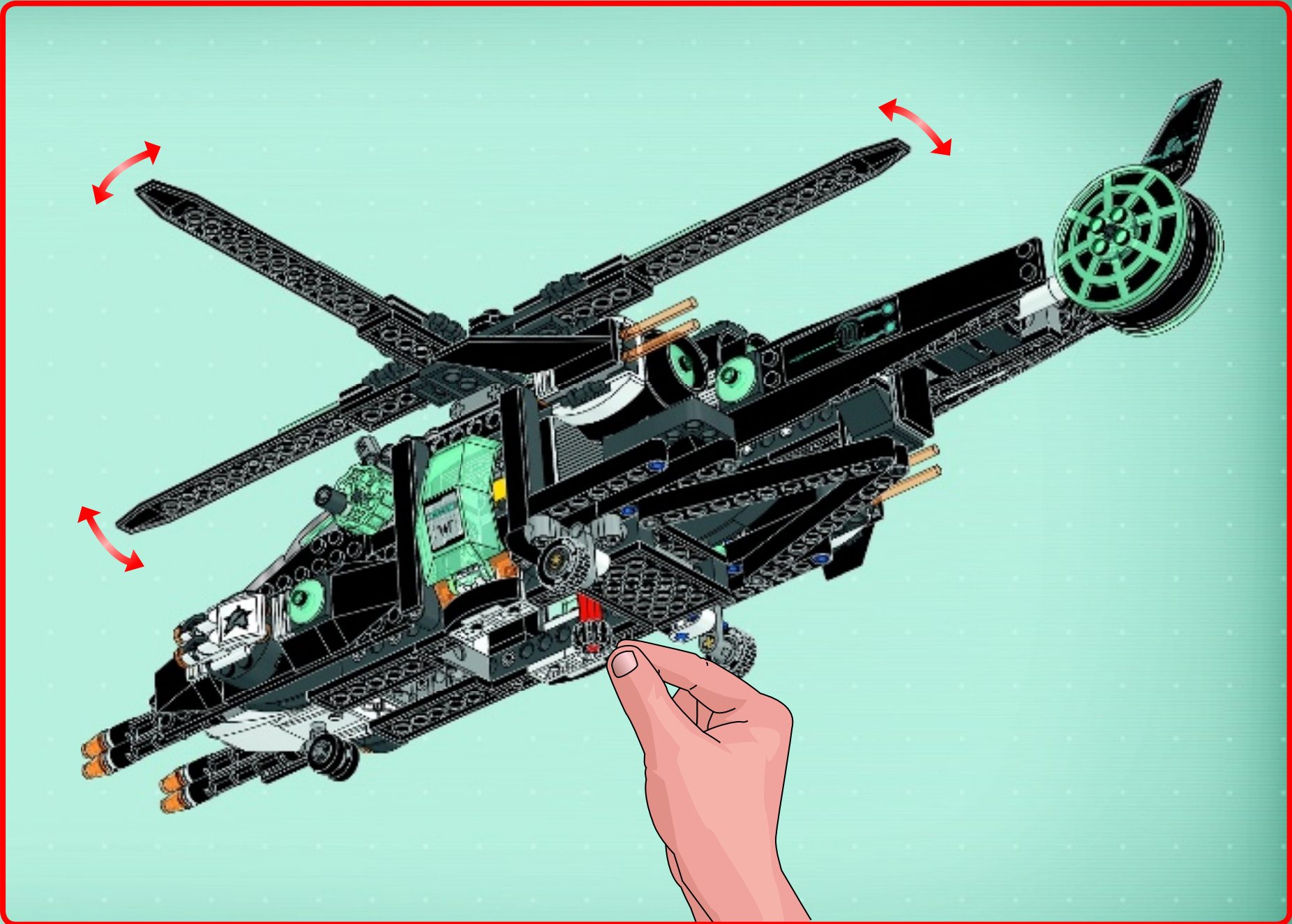



1



2



3

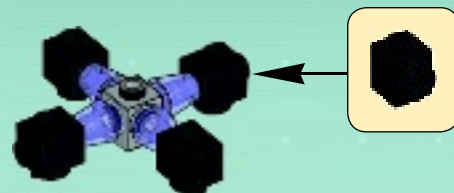

4



5



Download the app and use the AppBrick Gadget to complete the mission!

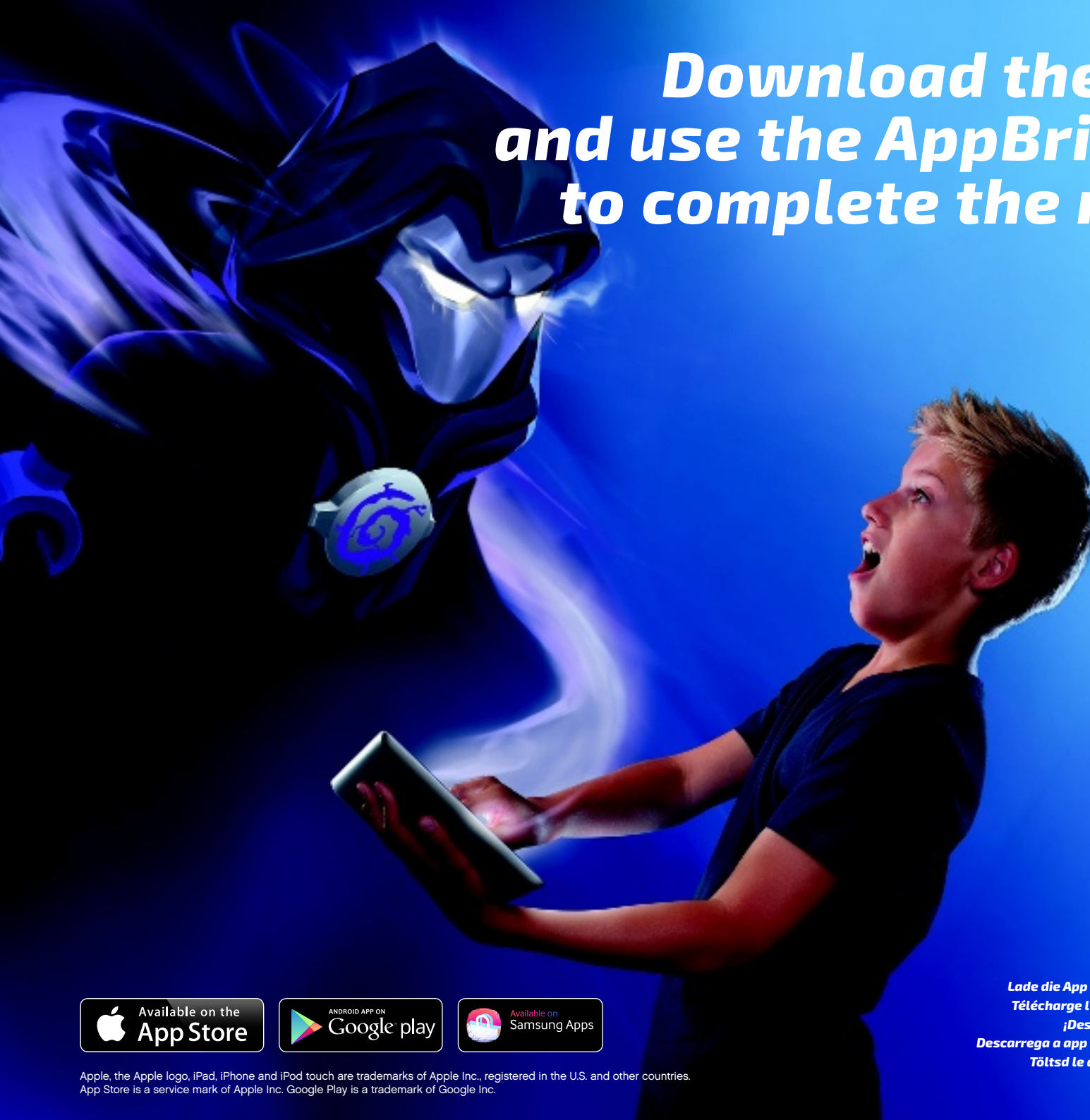

Apple, the Apple logo, iPad, iPhone and iPod touch are trademarks of Apple Inc., registered in the U.S. and other countries. App Store is a service mark of Apple Inc. Google Play is a trademark of Google Inc.

Lade die App herunter und beende die Mission mithilfe des AppBrick-!
Télécharge l'application et utilise l'AppBrick pour réussir ta mission !
¡Descarga la app y usa el AppBrick para completar la misión!
Descarrega a app e usa o Gadget AppBrick para completares a tua missão!
Töltsd le az appot és az AppBrick eszközzel teljesítsd a küldetést!

下载应用程序并使用 AppBrick 工具来完成任务!

Unlock the secrets with the new AppBrick Gadgets



Schalte geheime Inhalte mit den neuen AppBricks frei!

Découvre de nombreux secrets avec l'AppBrick

Descubre los secretos con los nuevos AppBricks

Desbloqueia os segredos com os novos Gadgets AppBrick

Tárd fel a titkokat az új AppBrick eszközökkel!

使用新的 AppBrick 工具来解锁秘密



ULTRA AGENTS



70168



70169



70166



70167



70170



42037



42038



42039

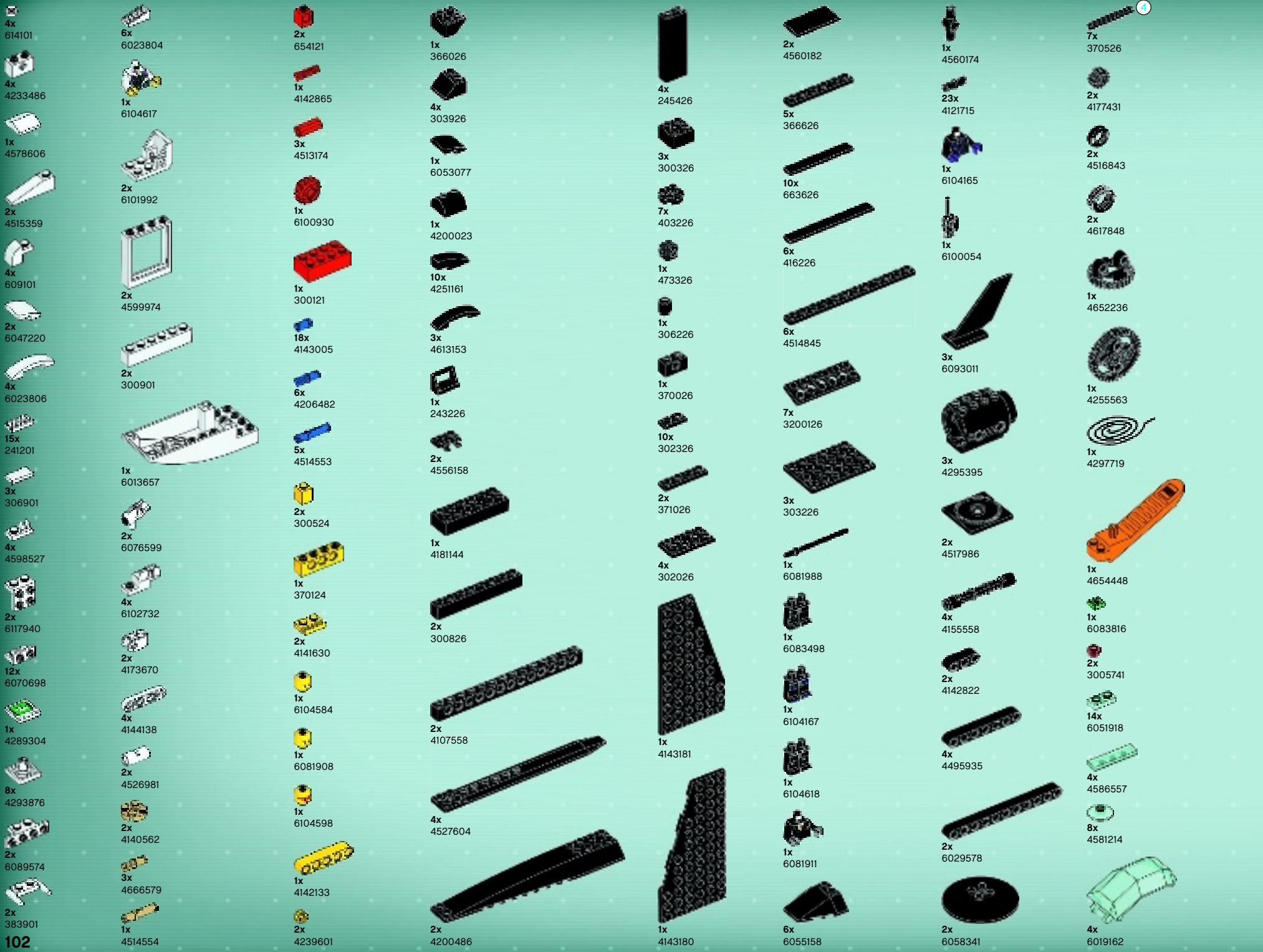

4x 614101
 4x 4233486
 1x 4578606
 2x 4515359
 4x 609101
 2x 6047220
 4x 6023806
 15x 241201
 3x 306901
 4x 4598527
 2x 6117940
 12x 6070698
 1x 4289304
 8x 4293876
 2x 6089574
 2x 383901

6x 6023804
 1x 6104617
 2x 6101992
 2x 4599974
 2x 300901
 1x 6013657
 2x 6076599
 4x 6102732
 2x 4173670
 4x 4144138
 2x 4526981
 2x 4140562
 3x 4666579
 1x 4514554

2x 654121
 1x 4142865
 3x 4513174
 1x 6100930
 1x 300121
 18x 4143005
 6x 4206482
 5x 4514553
 2x 300524
 1x 370124
 2x 4141630
 1x 6104584
 1x 6081908
 1x 6104598
 1x 4142133
 2x 4239601

1x 366026
 4x 303926
 1x 6053077
 1x 4200023
 10x 4251161
 3x 4613153
 1x 243226
 2x 4556158
 1x 4181144
 2x 300826
 2x 4107558
 4x 4527604
 2x 4200486

4x 245426
 3x 300326
 7x 403226
 1x 473326
 1x 306226
 1x 370026
 10x 302326
 2x 371026
 4x 302026
 1x 4143181
 1x 4143180

2x 4560182
 5x 366626
 10x 663626
 6x 416226
 6x 4514845
 7x 3200126
 3x 303226
 1x 6081988
 1x 6083498
 1x 6104167
 1x 6104618
 1x 6081911
 6x 6055158

1x 4560174
 23x 4121715
 1x 6104165
 1x 6100054
 3x 6093011
 3x 4295395
 2x 4517986
 4x 4155558
 2x 4142822
 4x 4495935
 2x 6029578
 2x 6058341

7x 370526
 2x 4177431
 2x 4516843
 2x 4617848
 1x 4652236
 1x 4255563
 1x 4297719
 1x 4654448
 1x 6083816
 2x 3005741
 14x 6051918
 4x 4586557
 8x 4581214
 4x 6019162

1x
6097145

1x
6103865

1x
4654432

3x
6096296

2x
6081809

6x
4567340

1x
6104175

1x
6106812

1x
6101092

1x
6104171

1x
6103301

3x
6101100

10x
4222960

4x
4567338

4x
4244369

5x
6072635

1x
4625528

1x
6102608

1x
6102607

1x
6055631

3x
4211388

1x
4211511

9x
4211636

3x
6057616

2x
6078985

1x
4211676

2x
4211466

1x
4211640

1x
6075237

1x
4243797

2x
4211452

2x
6043656

2x
4654580

3x
4654582

4x
4535738

1x
4654577

1x
6019212

1x
4585429

2x
4618324

1x
4514195

2x
4211506

1x
4519013

1x
4542590

2x
6101993

2x
4520320

2x
4211862

1x
4552348

2x
4211621

1x
4225033

2x
4296059

2x
4563045

3x
4211758

7x
4211807

1x
4211551

2x
4211815

2x
4211536

1x
4211639

1x
4535768

1x
4652235

2x
4640536

2x
4558959

3x
4211024

2x
4211076

4x
4210779

2x
4211094

5x
4565322

2x
4211043

1x
4211002

1x
4211134

2x
4257526

4x
4256828

4x
4260707

1x
6055313

6x
6051334

1x
4239891

4x
6048898

2x
6100030

2x
4210753

6x
4645730

4x
6083620

1x
4508553

1x
4499858

2x
6019987

16x
4210660

1x
6066952

4x
4521187

2x
6092604

4x
4523159

1x
6005755

4x
6092500

2x
6092499

9x
4633691

1x
6101923

2x
6103924

1x
6108536

1x
6006525

4x
6103777

Customer Service
Kundenservice
Service Consommateurs
Servicio Al Consumidor
LEGO.com/service or dial

: 00800 5346 5555
: 1-800-422-5346