

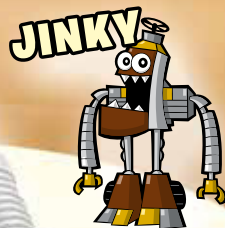

Mixels™

41537



7 LEGO.com

6126501

1

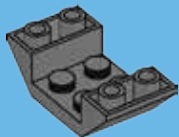

2

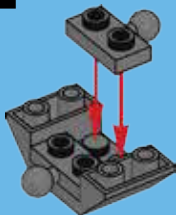

3

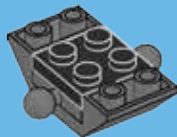

4

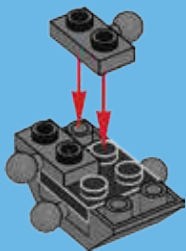

5



6

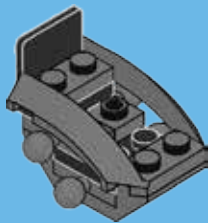

7

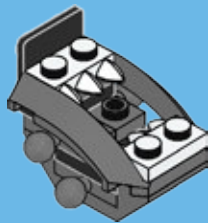

8



9



1

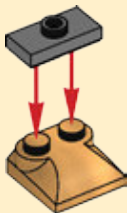

2

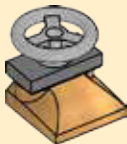

10





11



12



13



14



15



16

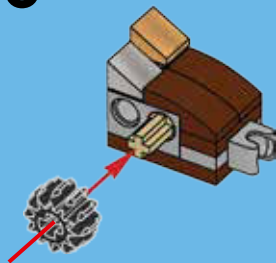

1

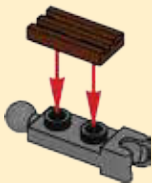

2



17

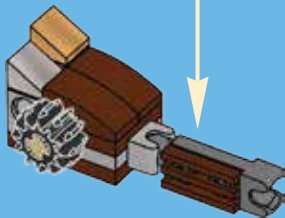

18

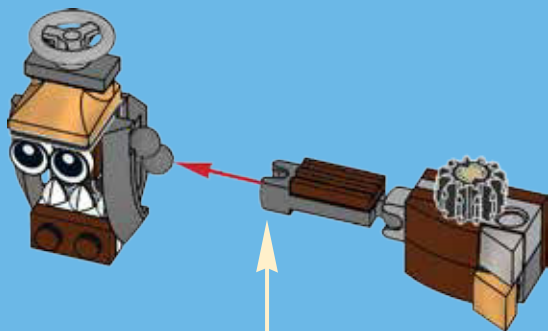



19



20



21



22



23

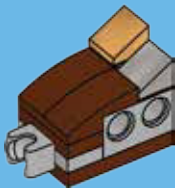

24

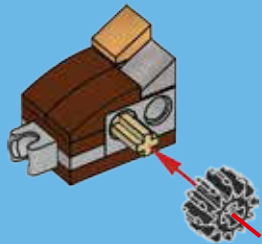

26

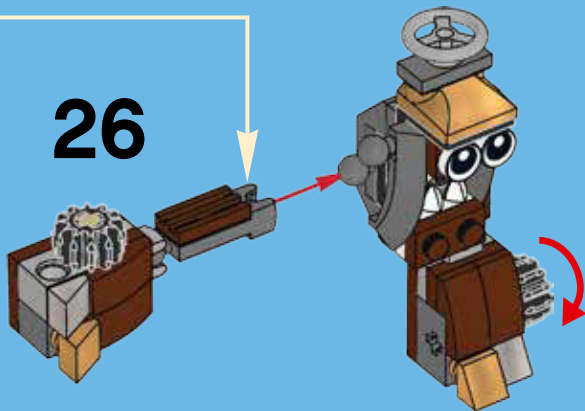



27

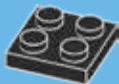

28



29



30



31

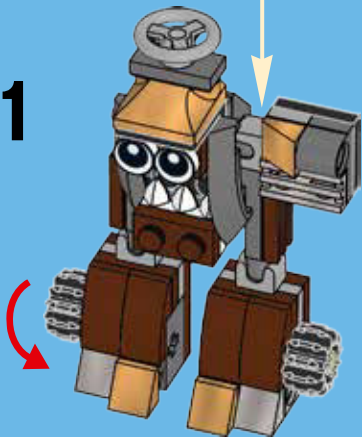



32

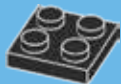

33

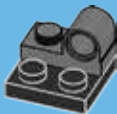

34



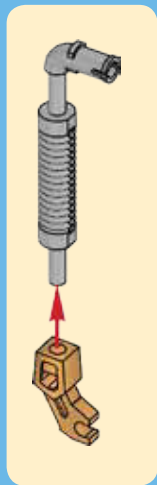

37

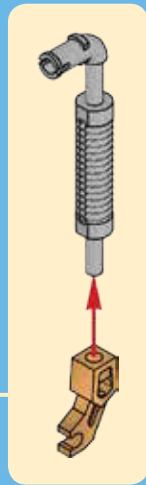
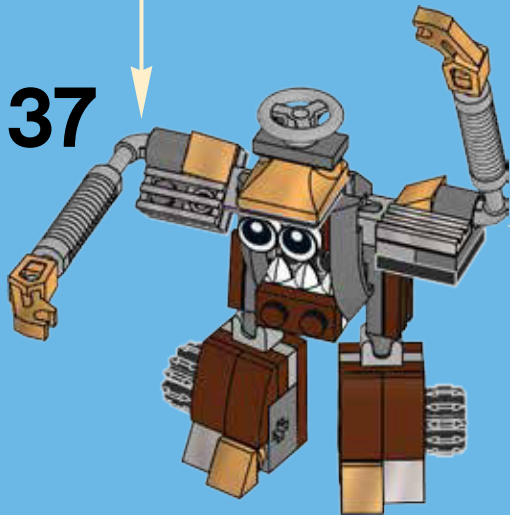



2x
6029156



2x
4177431



4x
6069984



2x
4211541



1x
6092572



4x
4587002



2x
6046381



3x
302226



2x
4224243



4x
6043656



2x
6019987



2x
4523159



2x
4666579



1x
6000650



4x
4211150



1x
6092956



4x
6039479



2x
6006741



2x
4211189



2x
6044706



2x
6039482



1x
4286597



Customer Service

Kundenservice

Service Consommateurs

Servicio Al Consumidor

LEGO.com/service or dial



00800 5346 5555 :



1-800-422-5346 :



1x
4294289



2x
4210935



2x
6078609



1x
4211076



2x
4619636



**GOX
41536**



**KLINKERS
MAX!**



**JINKY
41537**



**KAMZO
41538**



LEGO.com/mixels





Mixels™



**41536
GOX**



**41537
JINKY**



**41538
KAMZO**



**41539
KROG**



**41540
CHILBO**



**41541
SNOOF**



**41542
SPUGG**



**41543
TURG**



**41544
TUNGSTER**



LEGO.com/mixels





**YOU CAN
BUY THE
GAME!**

H 8 A V Y M 8 T A L

IN GAME CODE!

**MIXELS
RUSH**



Apple, the Apple logo, iPad, iPhone and iPod touch are trademarks of Apple Inc. Google Play is a trademark of Google Inc.



Mixels

JINKY
41537



MAX!



KAMZO
41538



GOX
41536



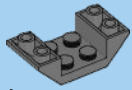

1x

1

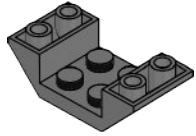

2x

2

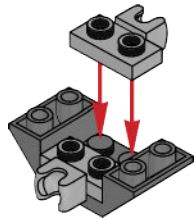



3

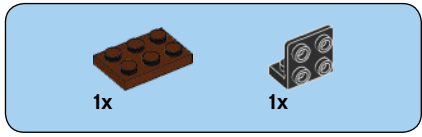
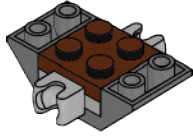

4

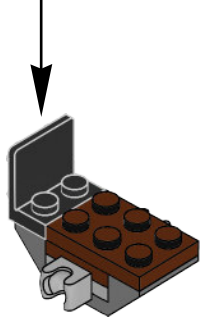
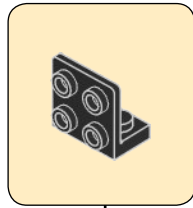

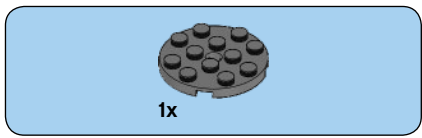

5

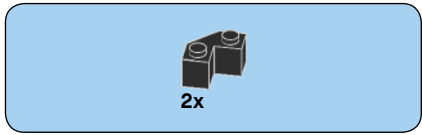
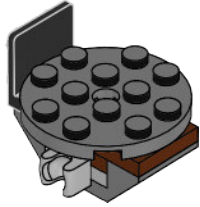

6

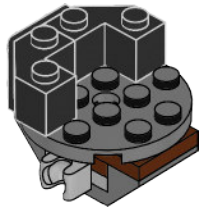

1x  2x  1x 

7

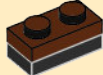
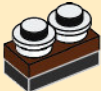
1  2  3 

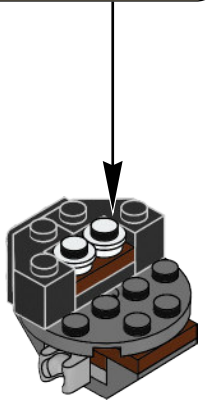

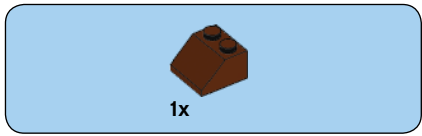

8

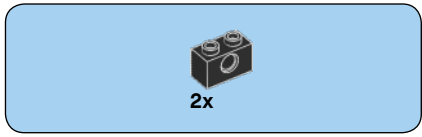
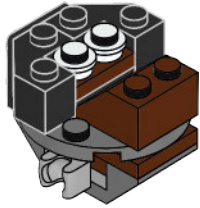

9

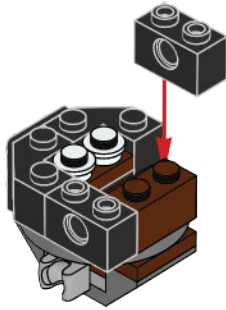

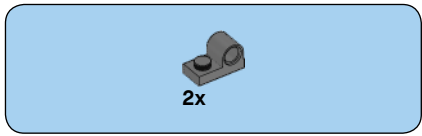

10

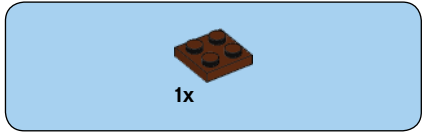
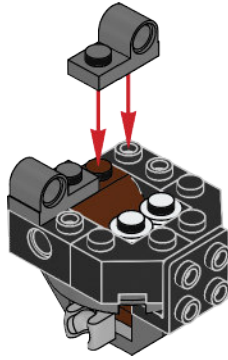

11

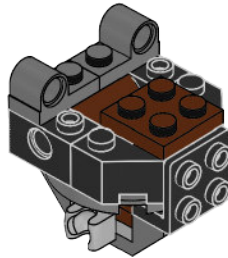

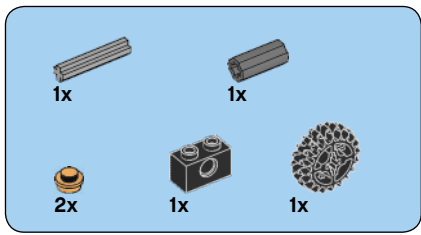

12

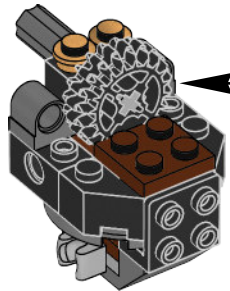
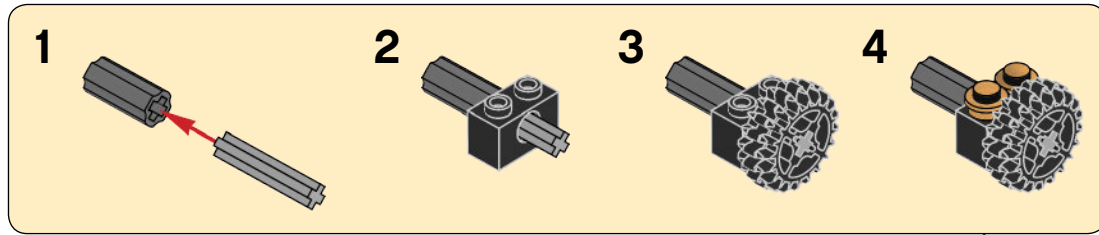

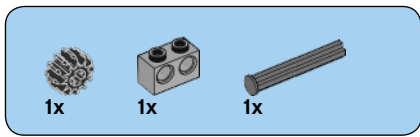

13

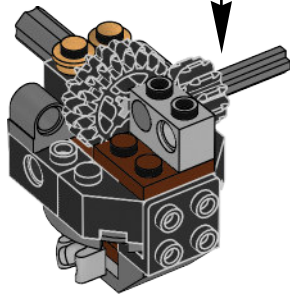
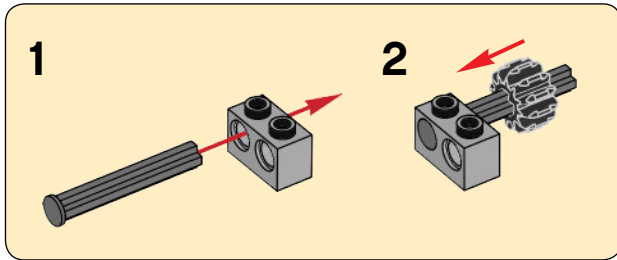

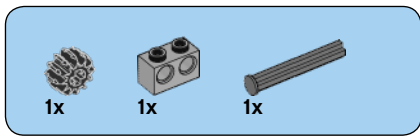

14

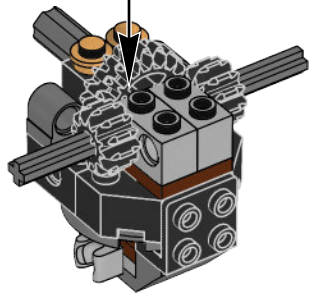
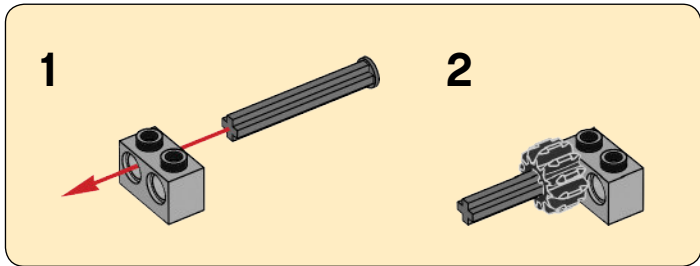

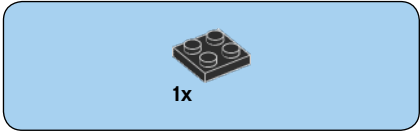
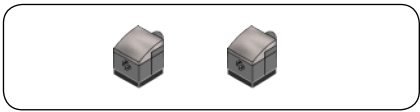

15

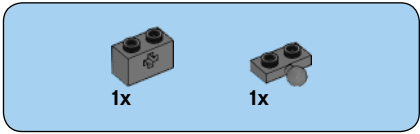
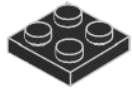

16

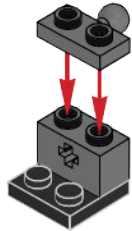



1x

17



1x

18

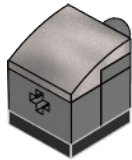

2x

19

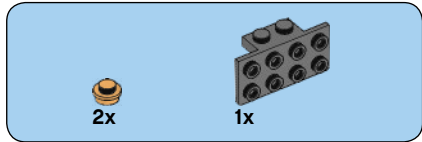
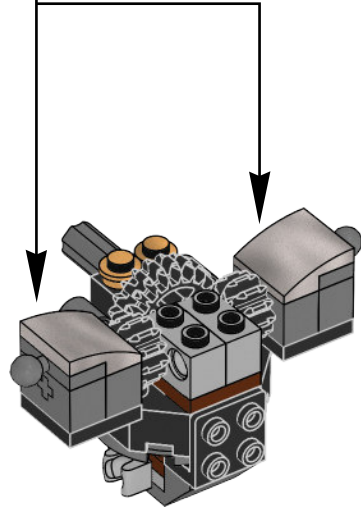

20

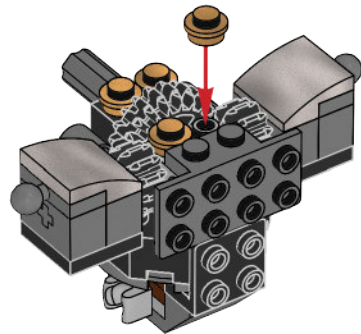

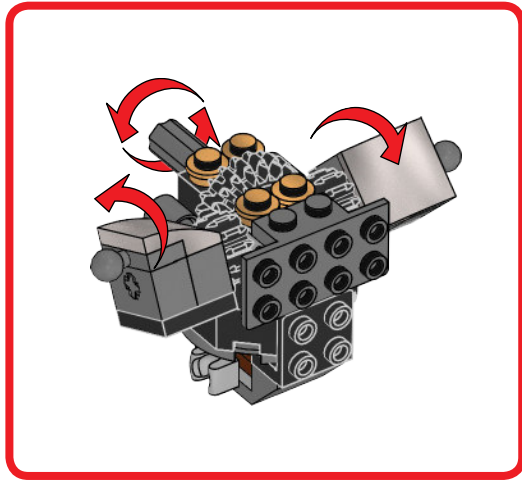

21

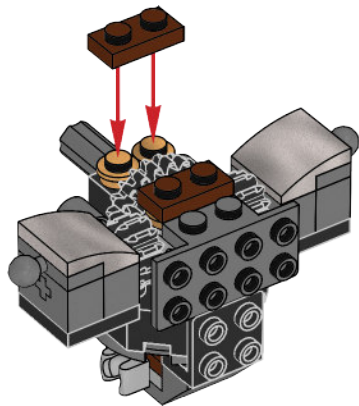

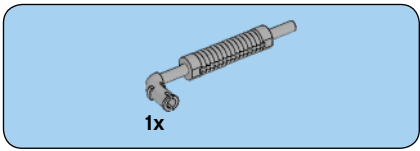

22

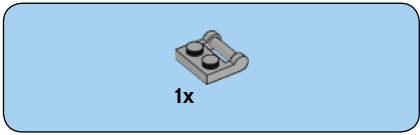
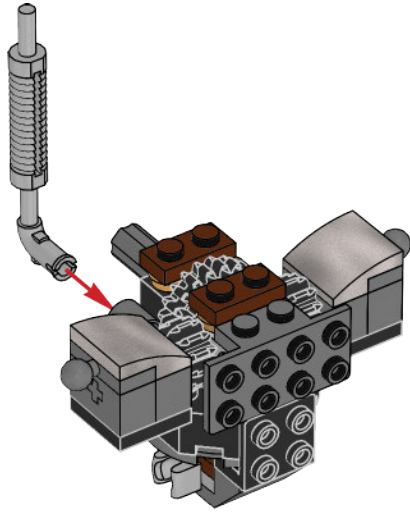

23

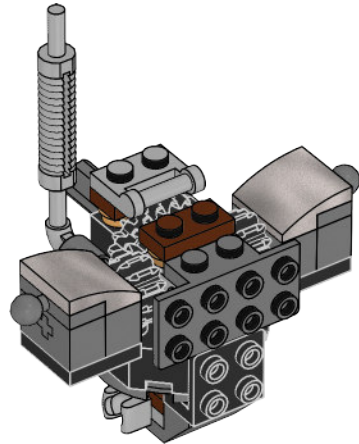

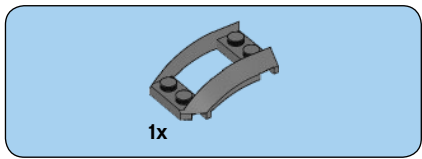

24

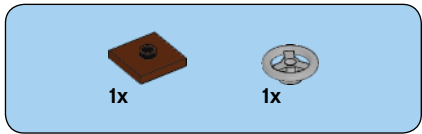
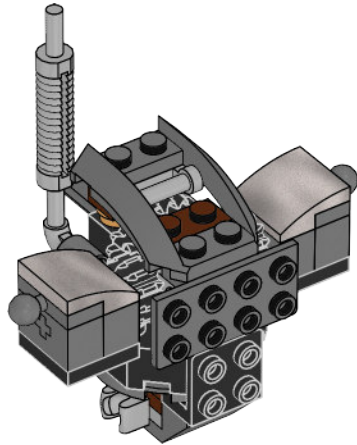

25

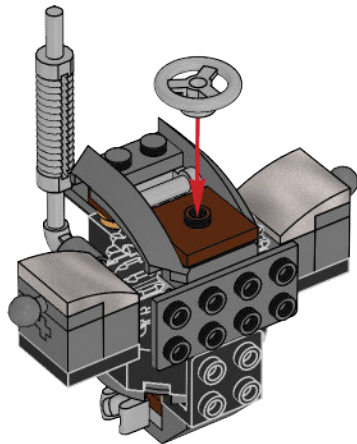

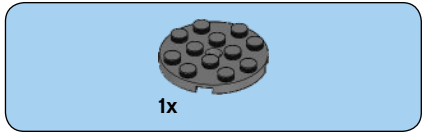

26

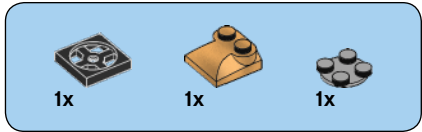
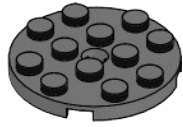

27



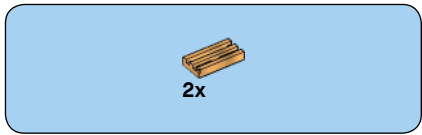

28

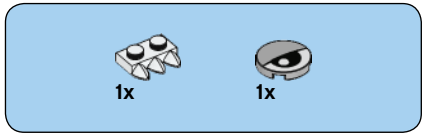

29





2x

30

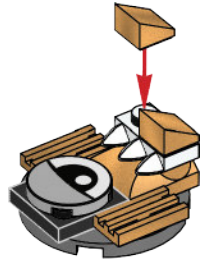

31

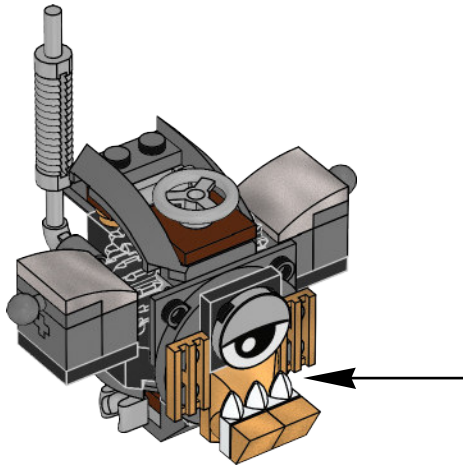

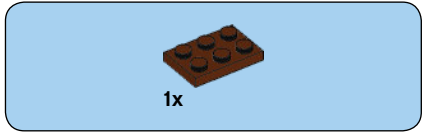
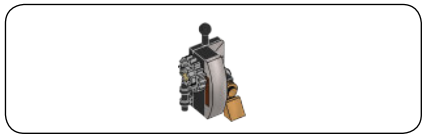

1x

32

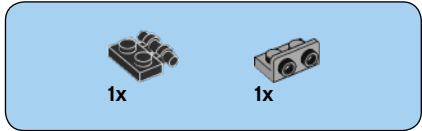

1x

1x

33

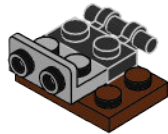

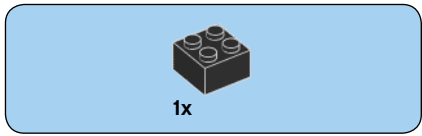

34

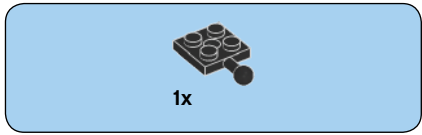
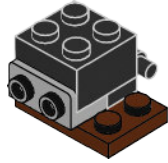

35

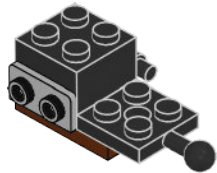

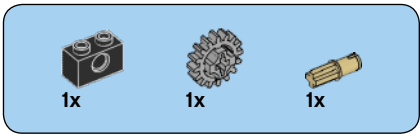

36

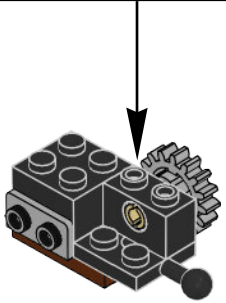
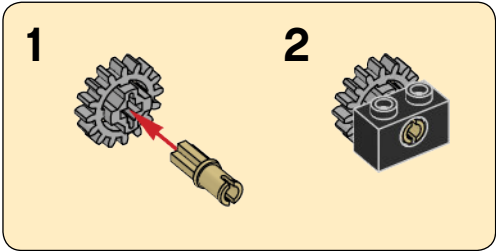

37

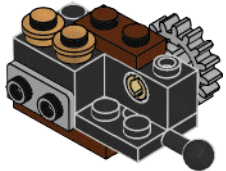



2x

38

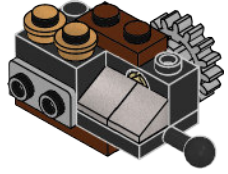

1x



1x

39

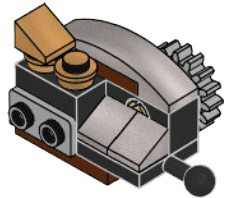

40

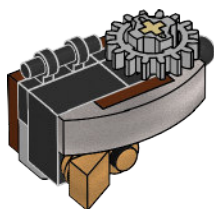
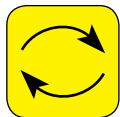

41

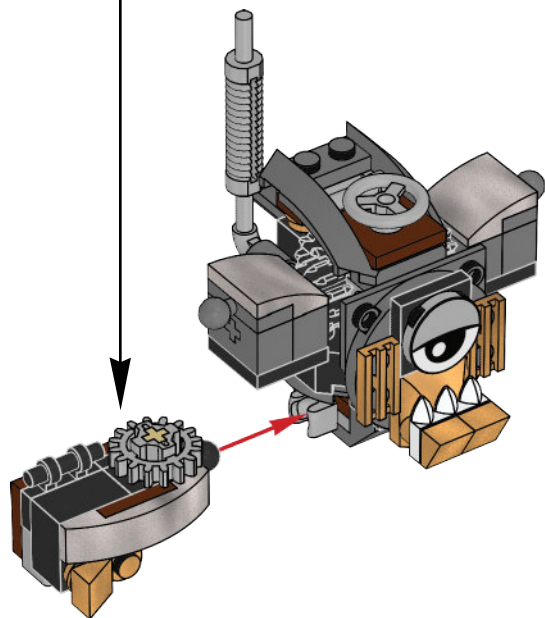

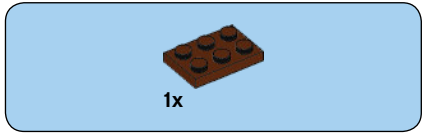
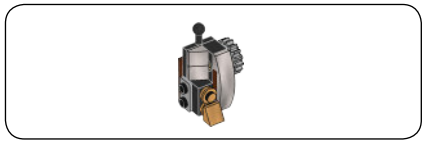

1x

42

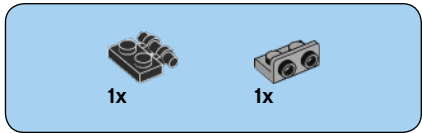

1x

1x

43

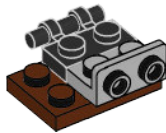

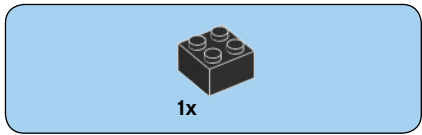

44

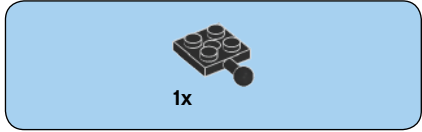
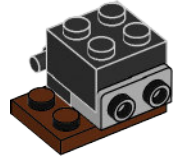

45

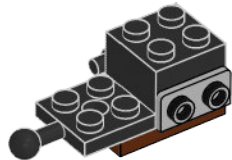

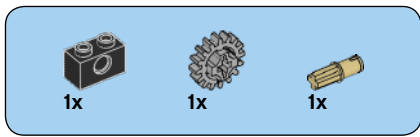

46

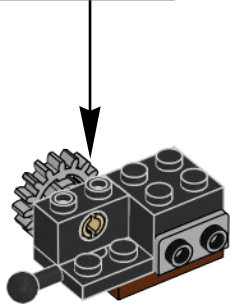
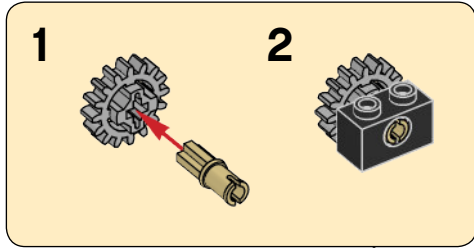

47

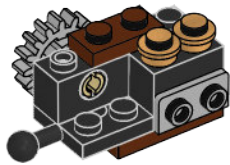



2x

48

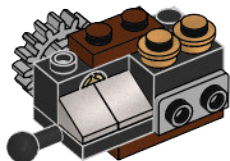

1x



1x

49

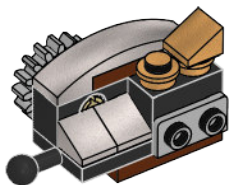

50

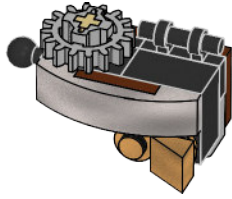
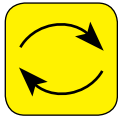

51

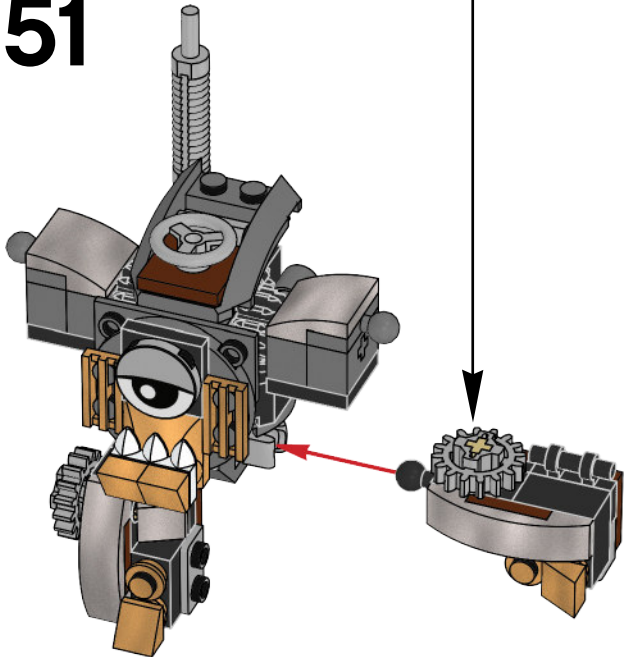

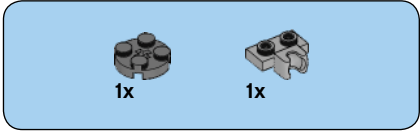
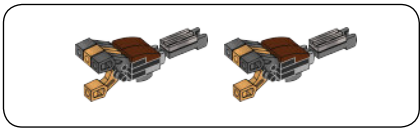

52

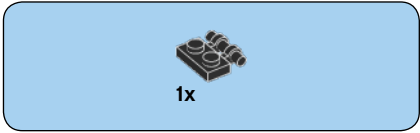
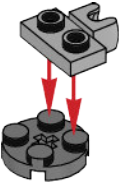

53





1x

54



1x

55



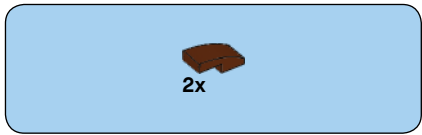

56

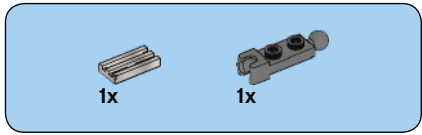
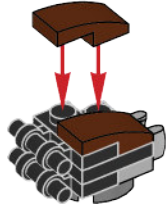

57

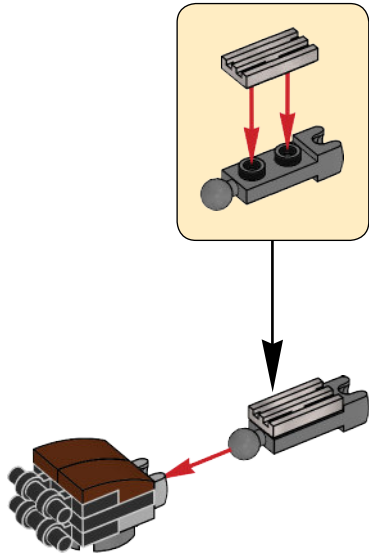



2x

58

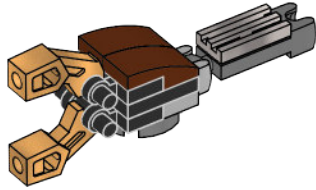

2x

59

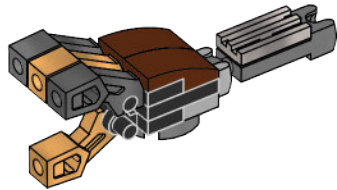

2x

60

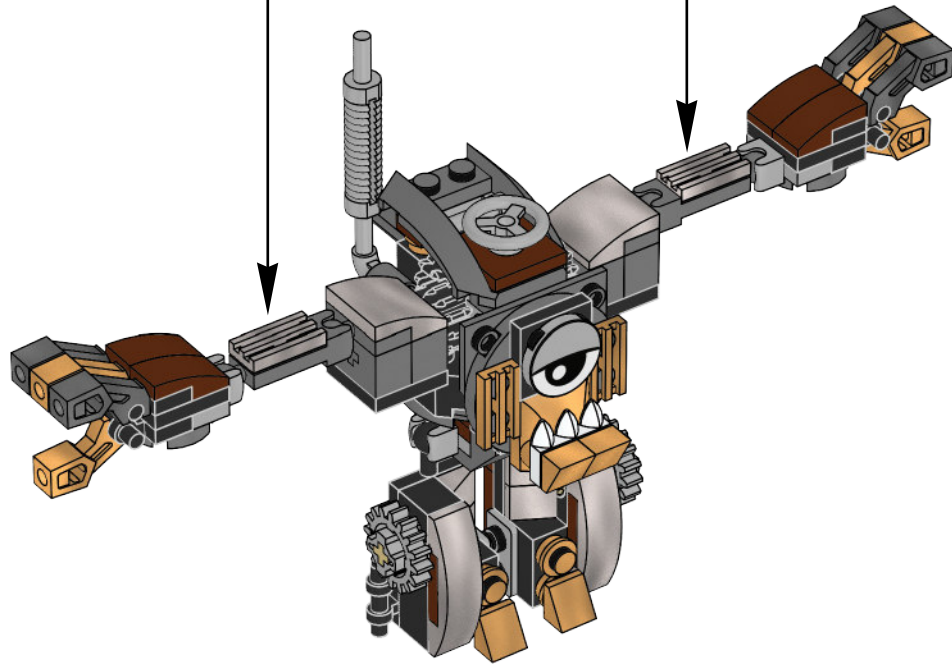

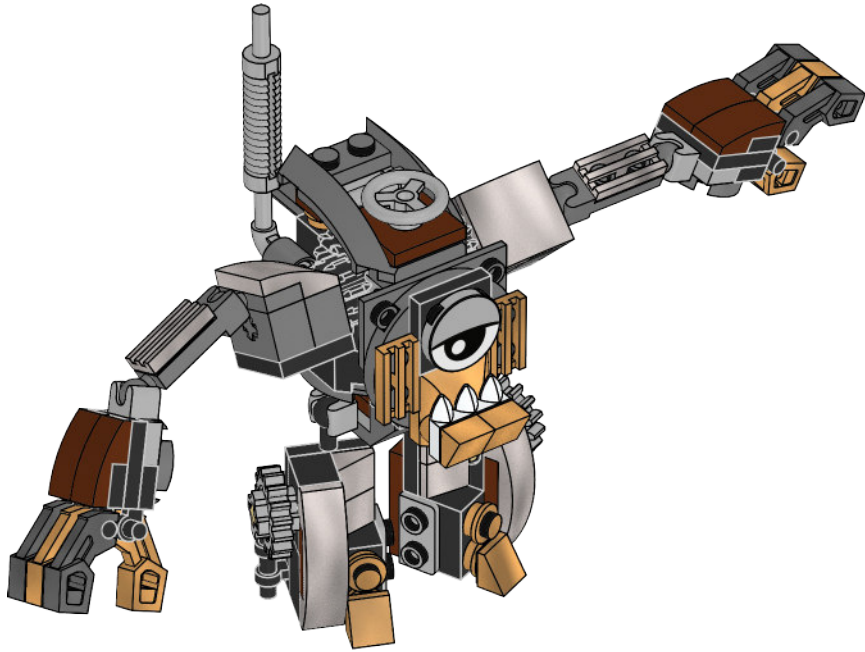



LEGO, the LEGO logo and MIXELS are trademarks of the/sont des marques de commerce du/son marcas registradas de LEGO Group. ©2015 The LEGO Group.

TM & © 2015 Cartoon Network