



Disney

10775



Check for compatibility
Kompatibilität prüfen
Vérifier la compatibilité
Controlla la compatibilità
Comprueba tu compatibilidad
Verificar a compatibilidade
Ellenőrizd a kompatibilitást
Pārbaudīt saderību
检查兼容性

LEGO.com/devicecheck



乐高®拼搭指引



LEGO® Building Instructions



Download on the
App Store



GET IT ON
Google Play



腾讯应用宝
安卓应用商店



Apple and the Apple logo are trademarks of Apple Inc.
Google Play and the Google Play logo are trademarks of Google LLC.
Tencent and the Tencent logo are trademarks of Tencent Inc.



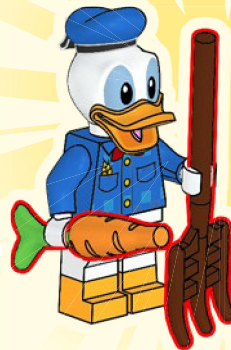
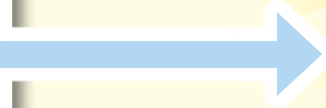
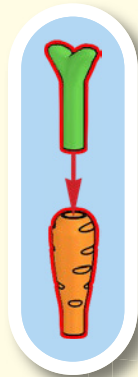
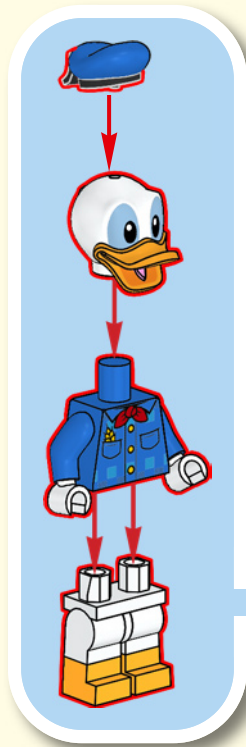

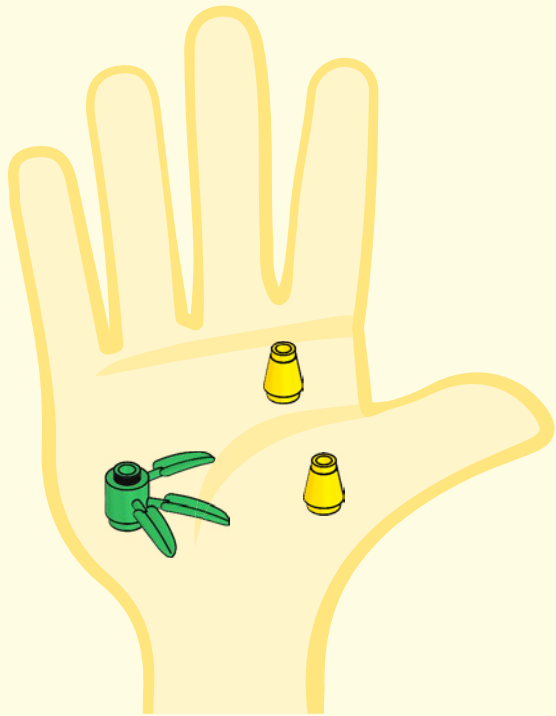
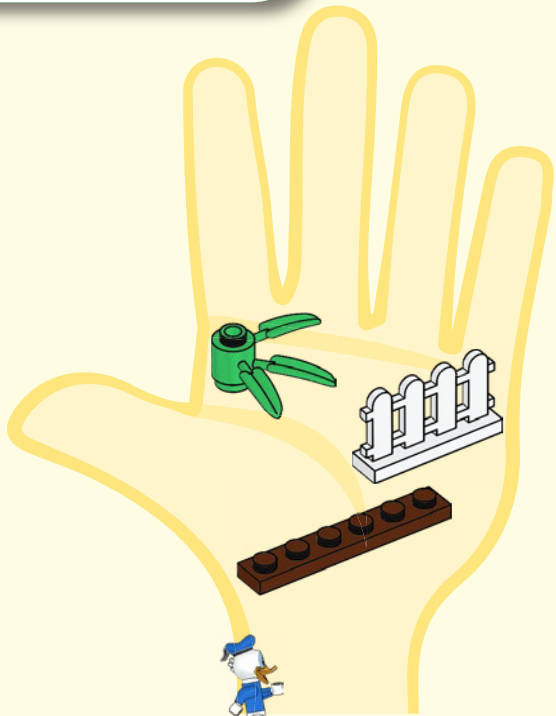
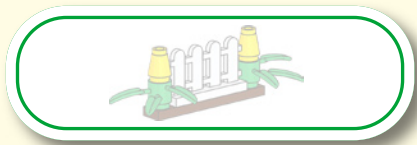

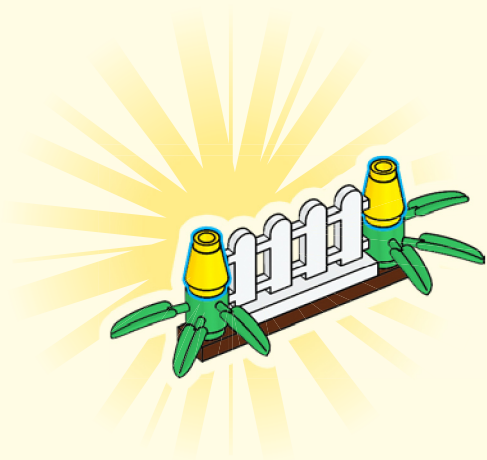
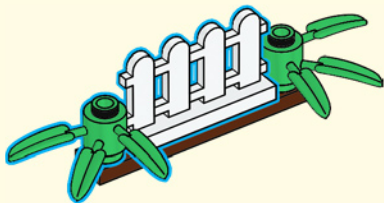
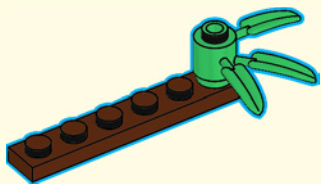

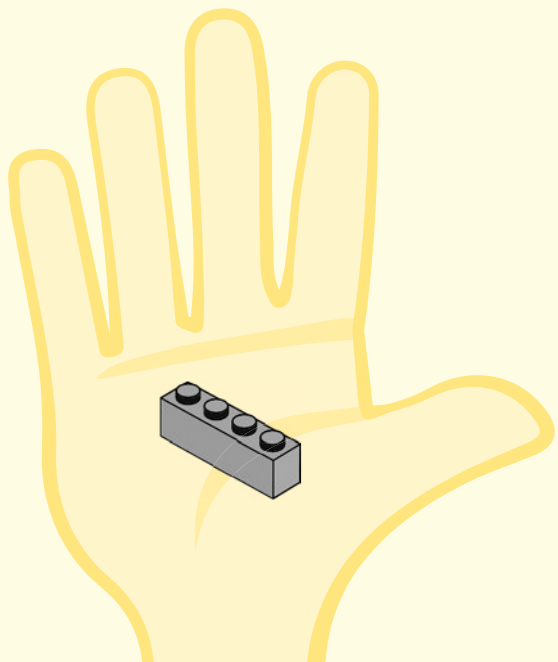
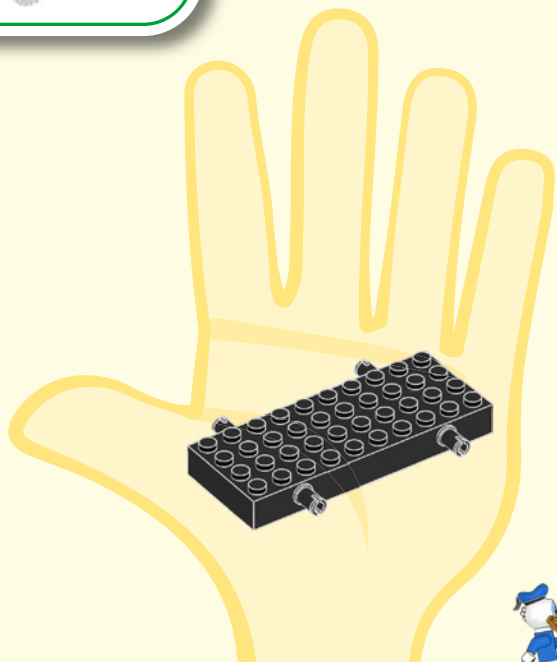
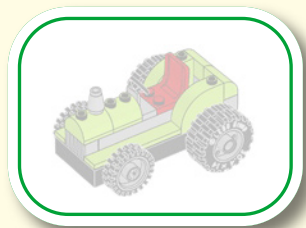

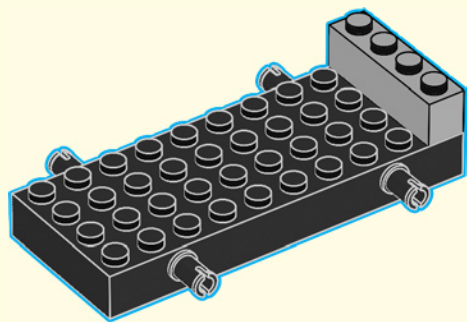

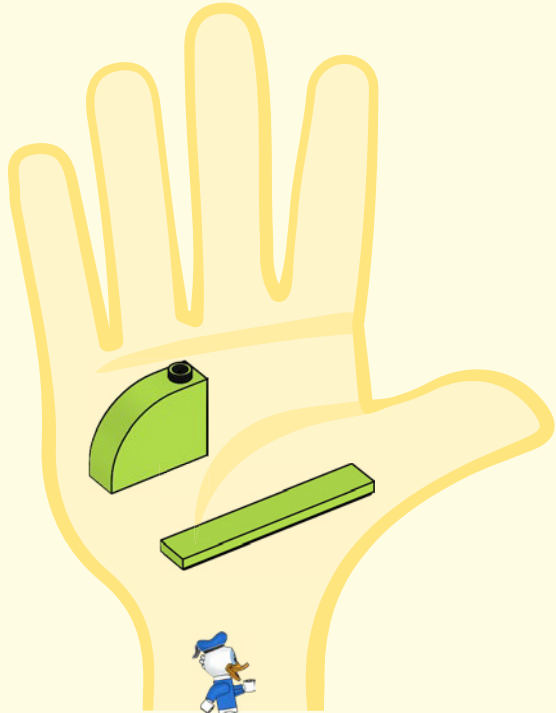
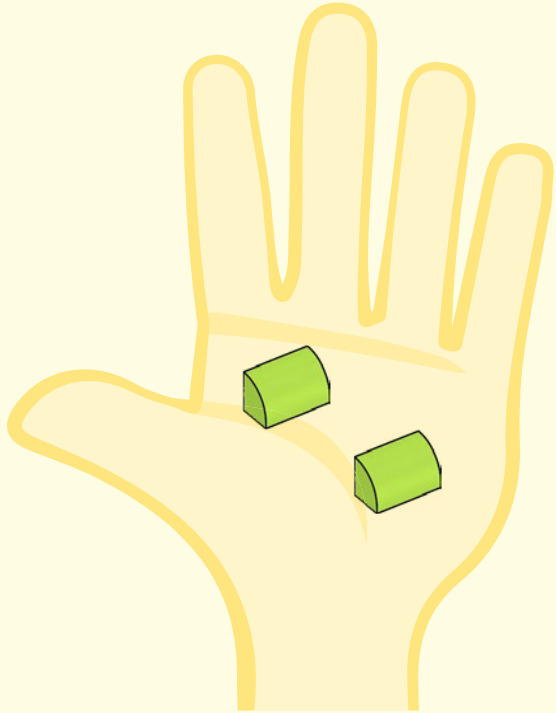

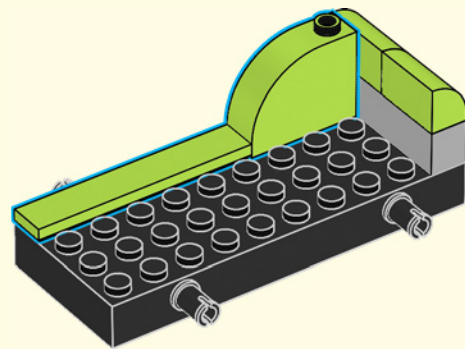
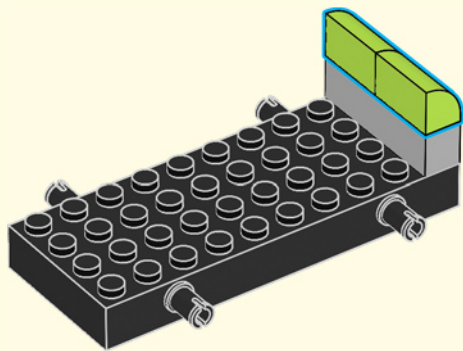

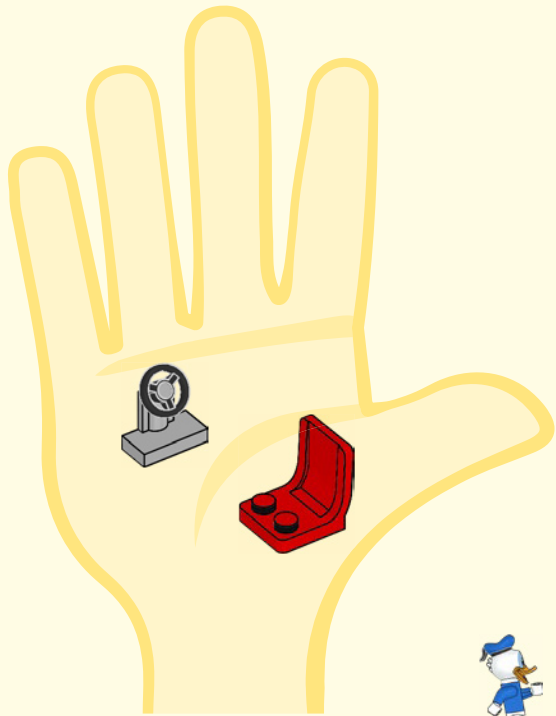
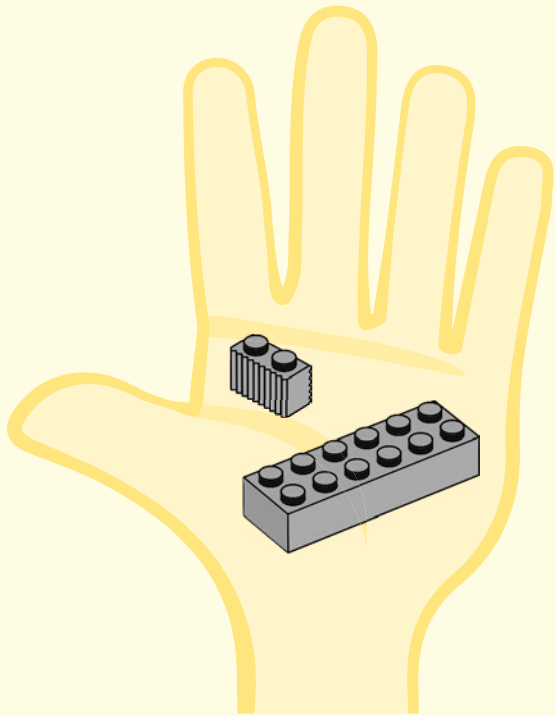

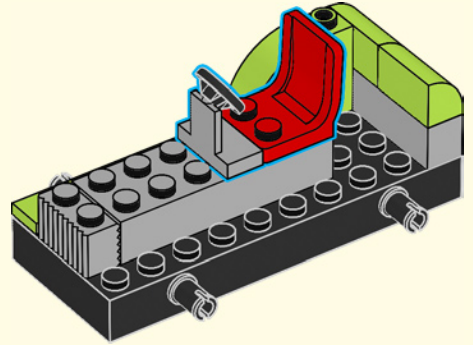
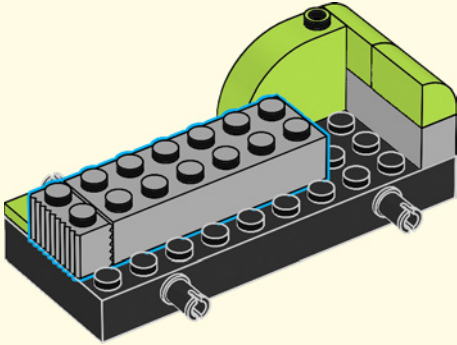

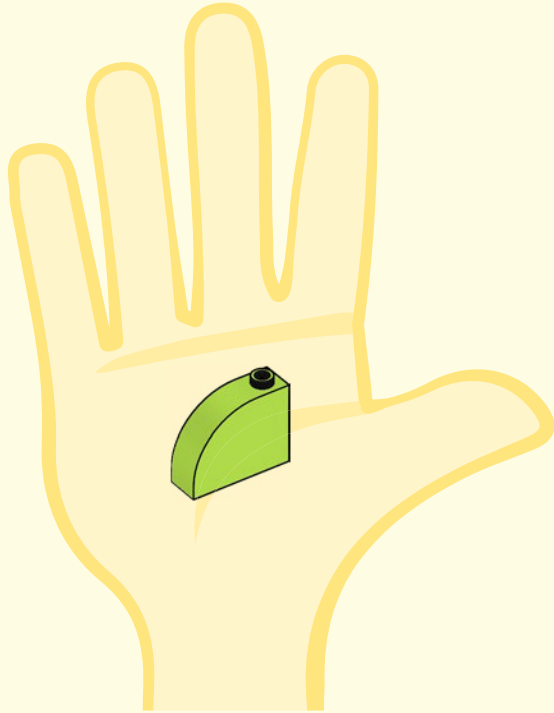
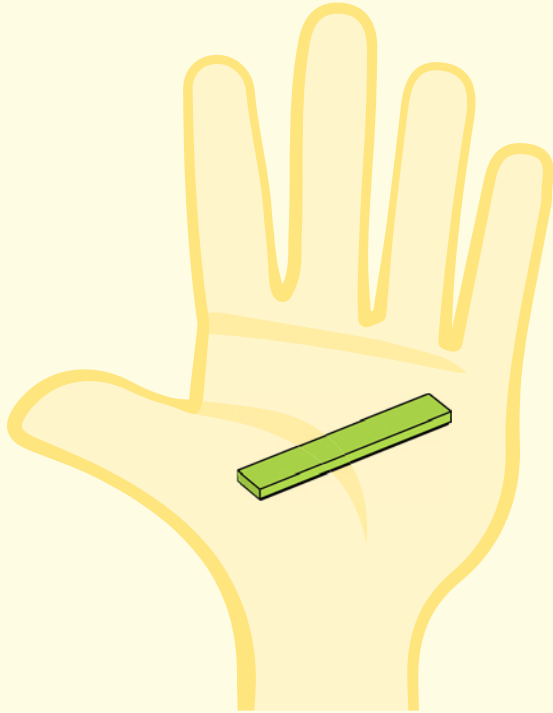

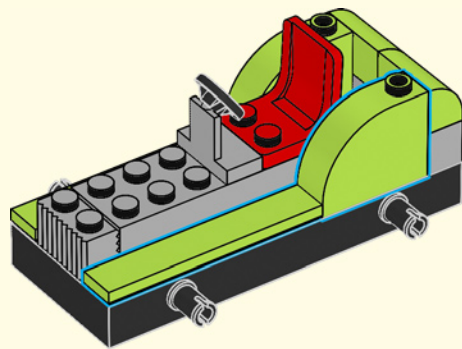

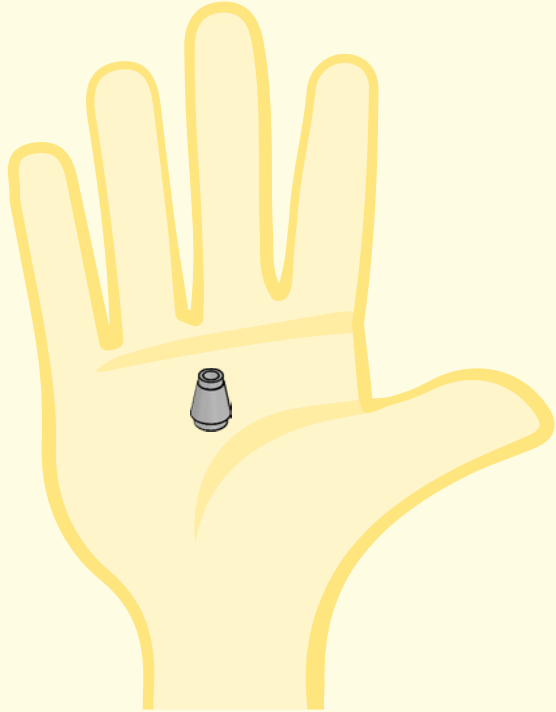
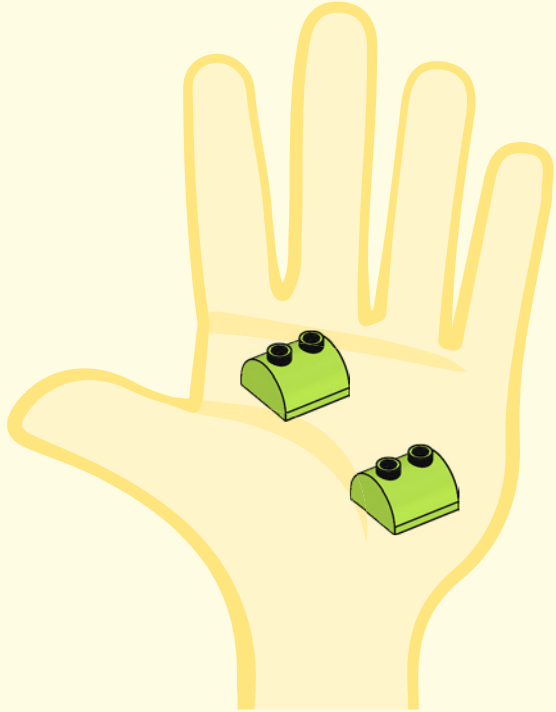

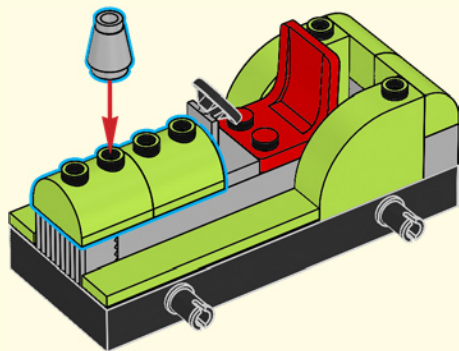

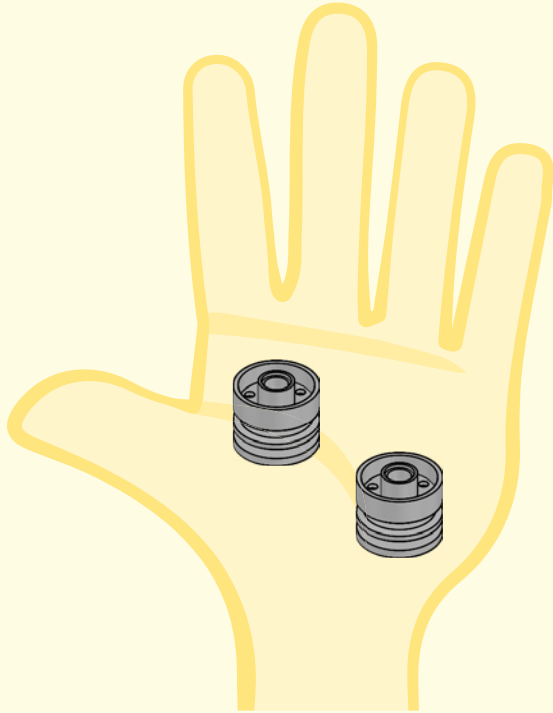

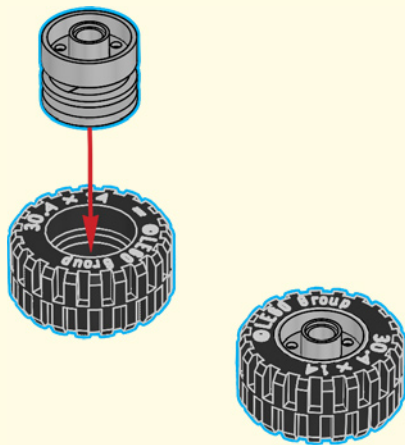

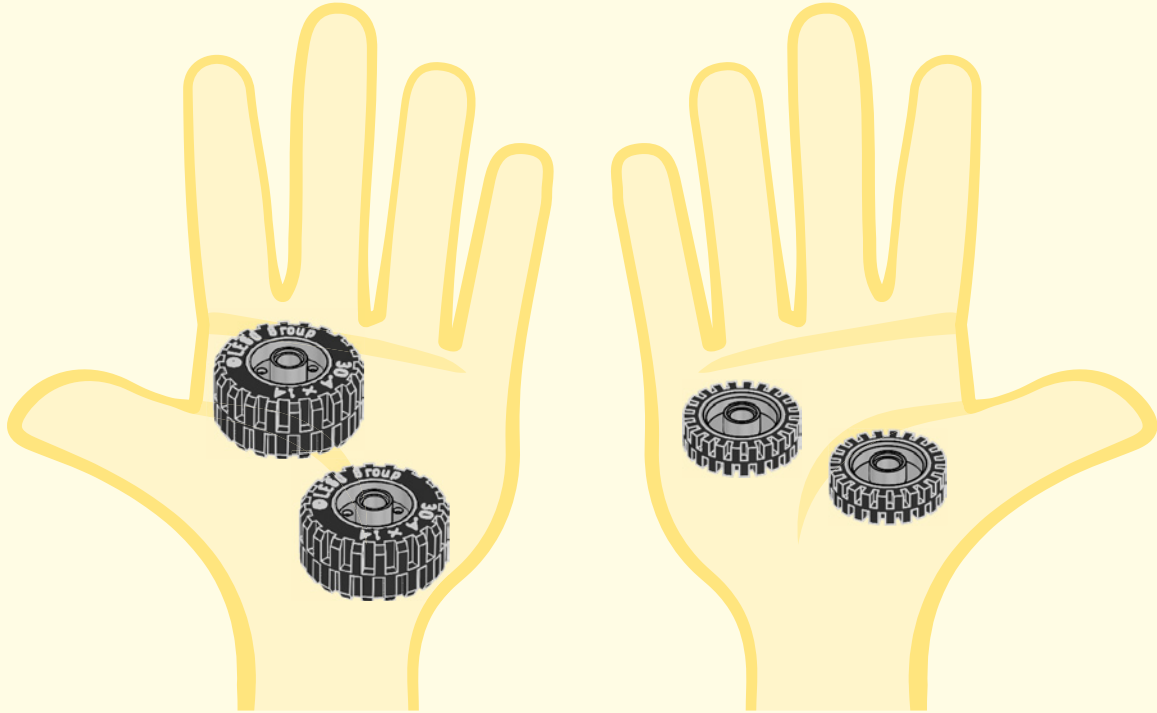

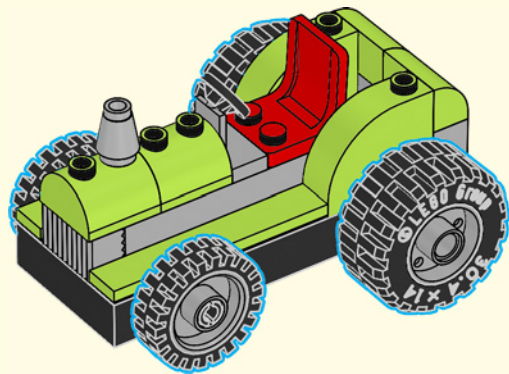

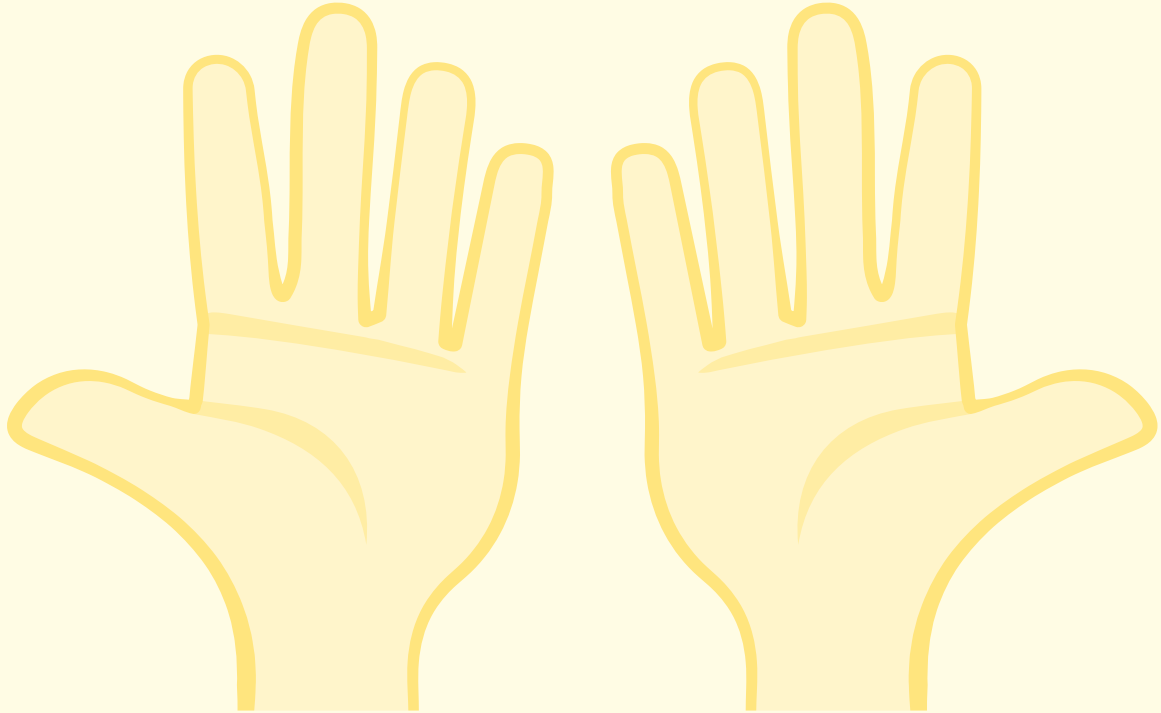

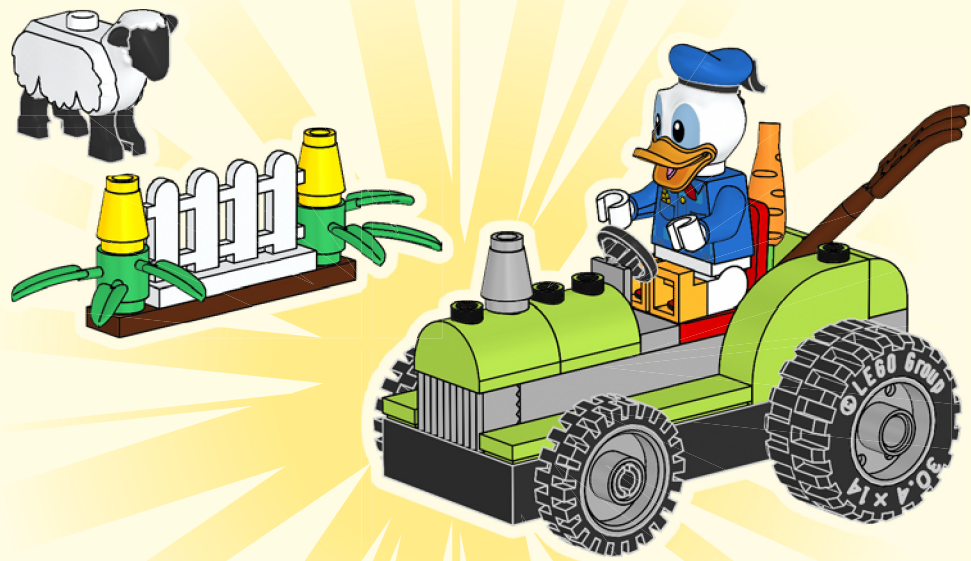



Rebuild
the
world™



Disney
MICKEY
AND FRIENDS



WIN

GO TO WWW.LEGO.COM/PRODUCTFEEDBACK AND
GIVE US YOUR SHORT **FEEDBACK** ABOUT THIS
LEGO® SET FOR A CHANCE TO WIN
A COOL LEGO PRIZE.

Terms & Conditions apply

LEGO.com/productfeedback



GEWINNE

Erzähle uns auf
www.LEGO.com/productfeedback

etwas über die Erfahrungen, die du mit
diesem LEGO® Set gemacht hast, und
sichere dir die Chance auf einen coolen
LEGO Preis!

Es gelten die Teilnahmebedingungen

GAGNE

Rends-toi sur
www.LEGO.com/productfeedback

et donne-nous quelques commentaires sur
ce produit LEGO® pour avoir une chance
de gagner un prix LEGO !

Voir Conditions Générales

GANAN

Visita
www.LEGO.com/productfeedback

y envíanos tu opinión acerca de este set
LEGO®. ¡Participarás en el sorteo de un
premio LEGO!

Términos y Condiciones aplicables

获取奖品

登录
www.LEGO.com/productfeedback

给出关于此乐高®套装的简短反馈，
就有机会获得炫酷乐高奖品

《条款及条件》适用

LEGO and the LEGO logo are trademarks of the LEGO Group. ©2021 The LEGO Group.



Disney

10775



2

Check for compatibility
Kompatibilität prüfen
Vérifier la compatibilité
Controlla la compatibilità
Comprueba tu compatibilidad
Verificar a compatibilidade
Ellenőrizd a kompatibilitást
Pārbaudīt saderību
检查兼容性

LEGO.com/devicecheck



乐高®拼搭指引



LEGO® Building Instructions



Download on the
App Store



GET IT ON
Google Play



腾讯应用宝
安卓应用商店



Apple and the Apple logo are trademarks of Apple Inc.
Google Play and the Google Play logo are trademarks of Google LLC.
Tencent and the Tencent logo are trademarks of Tencent Inc.

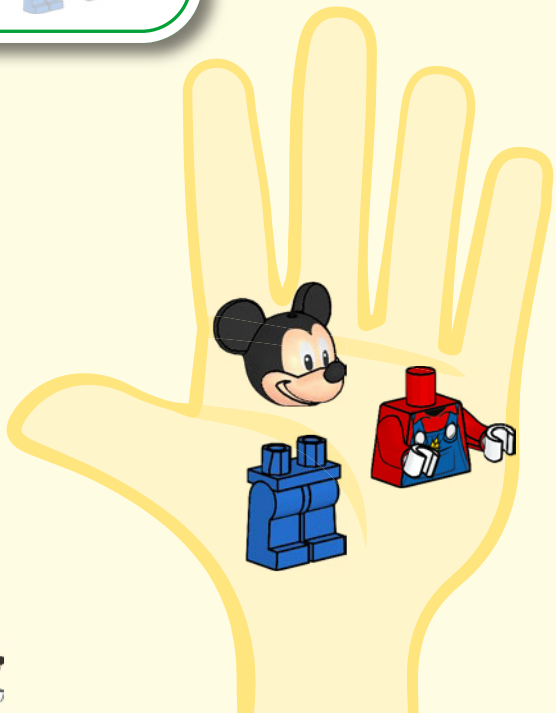

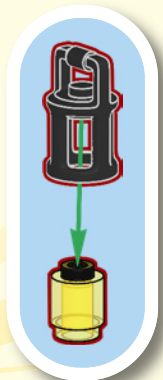
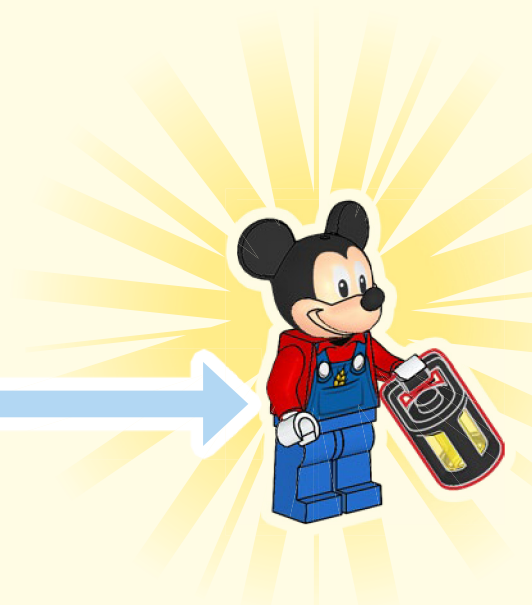
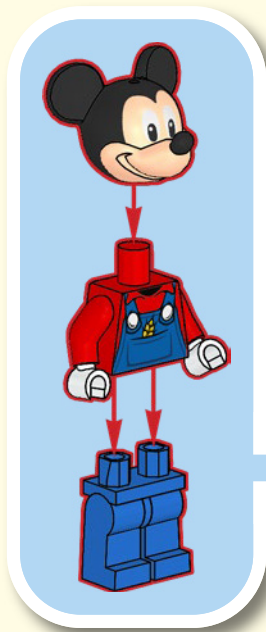

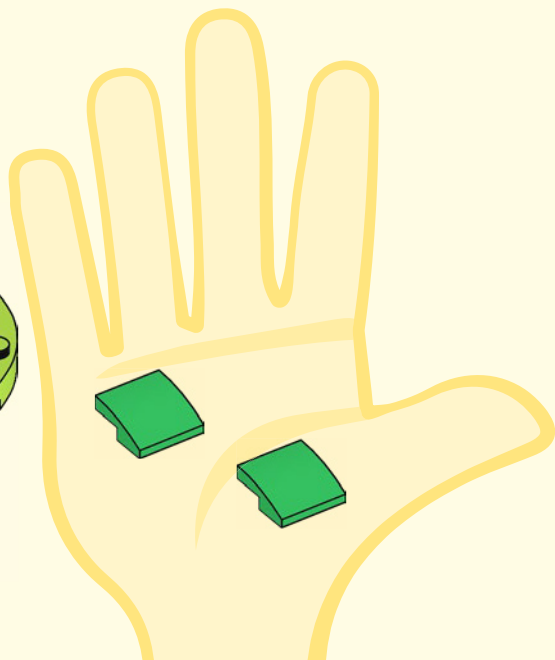
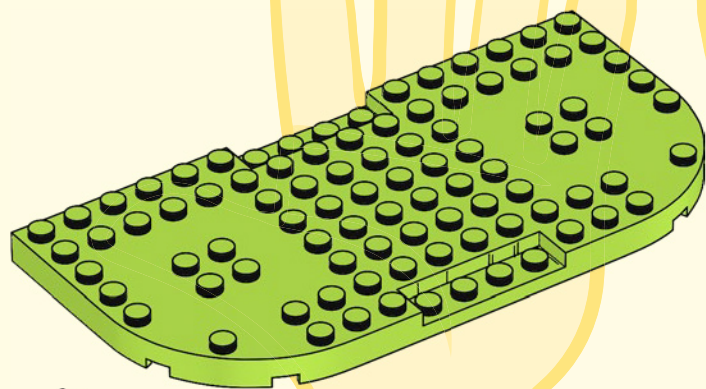

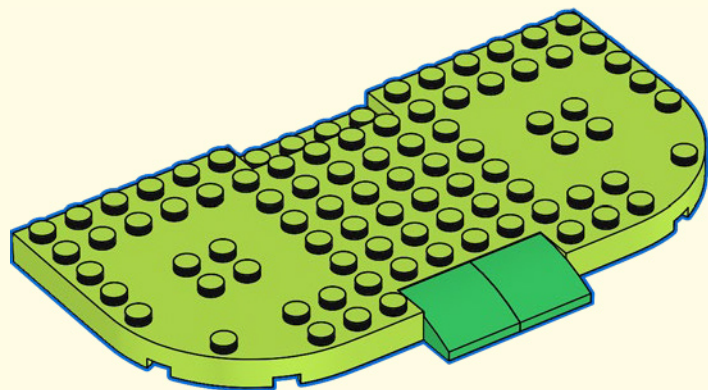

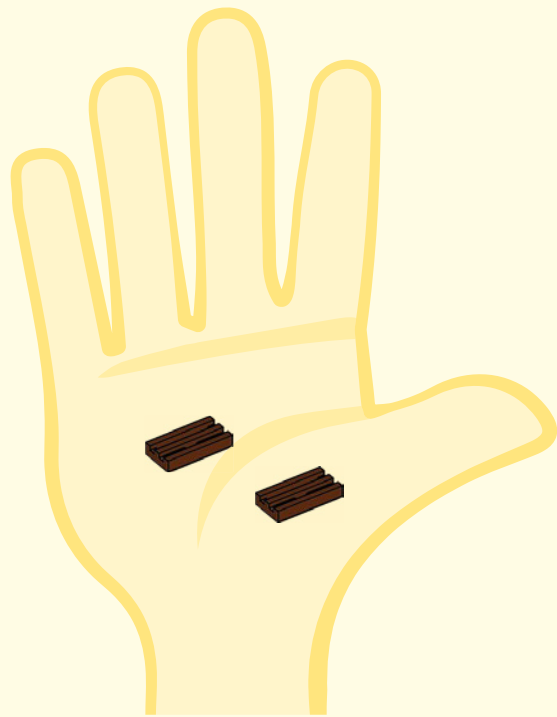

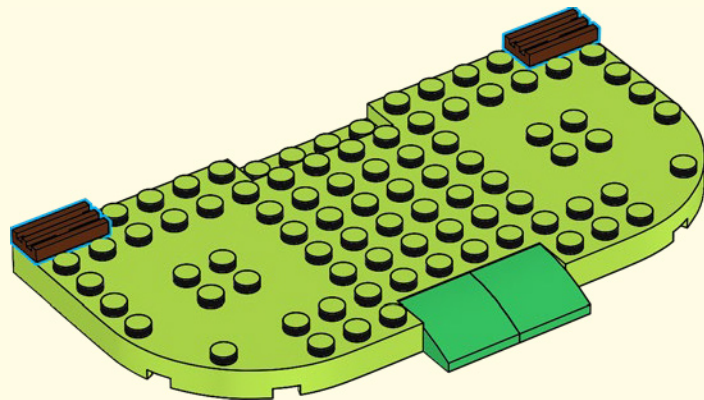

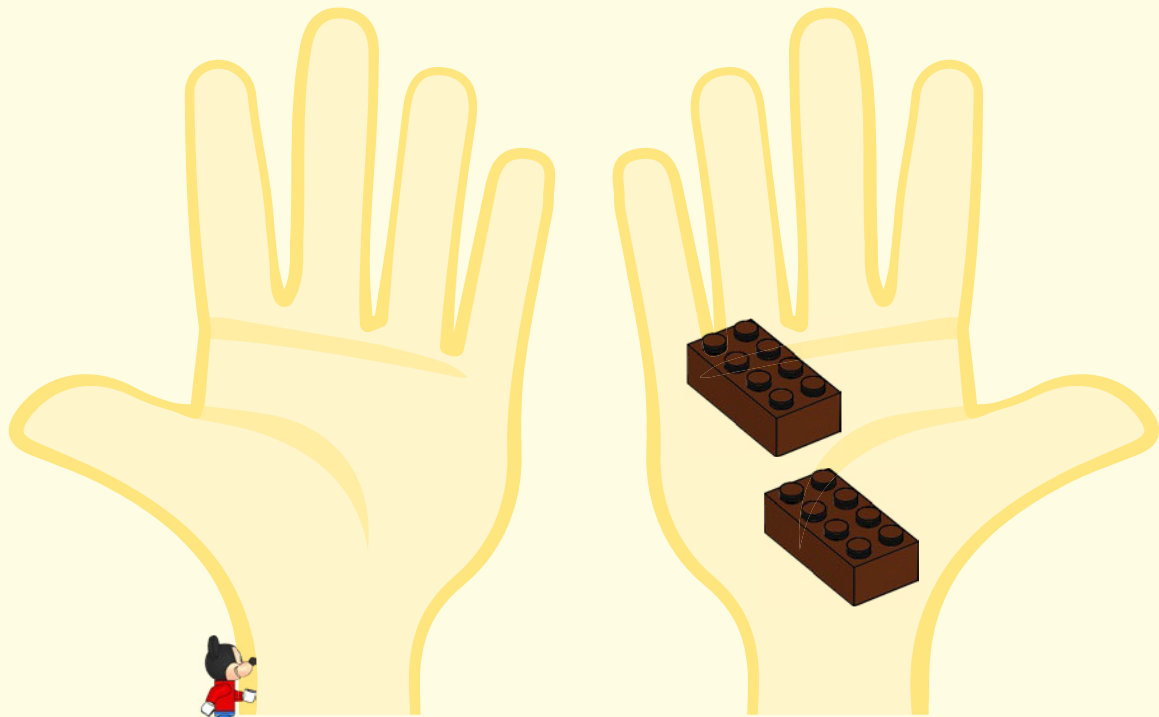

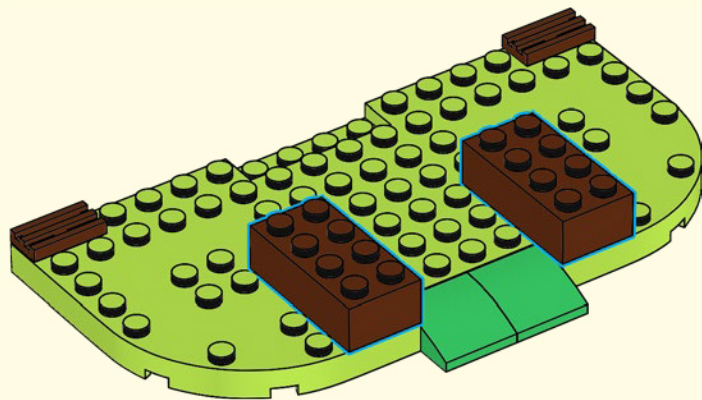

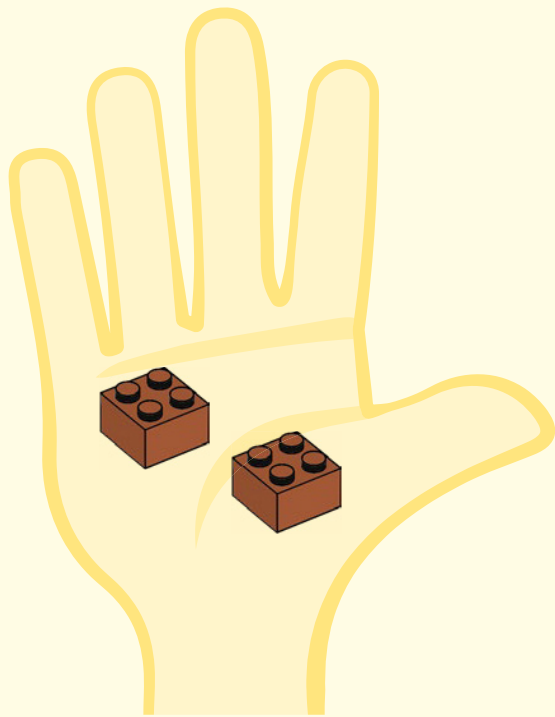

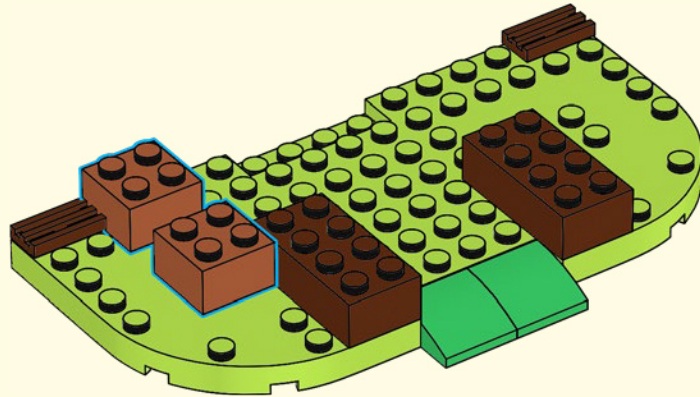

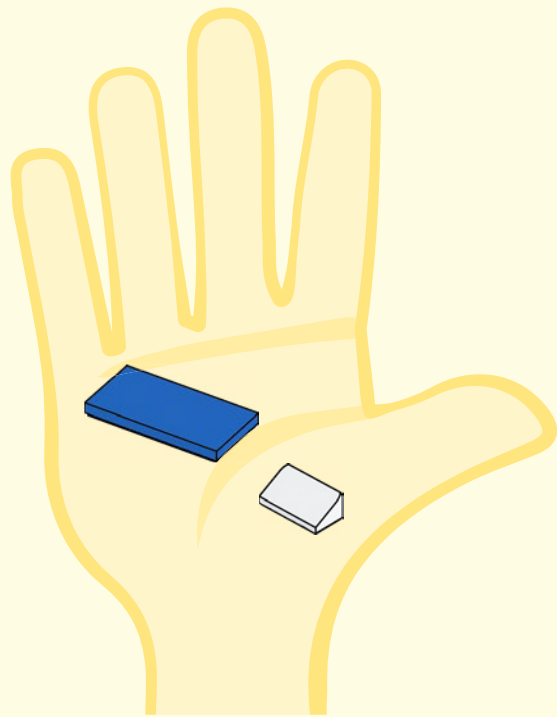

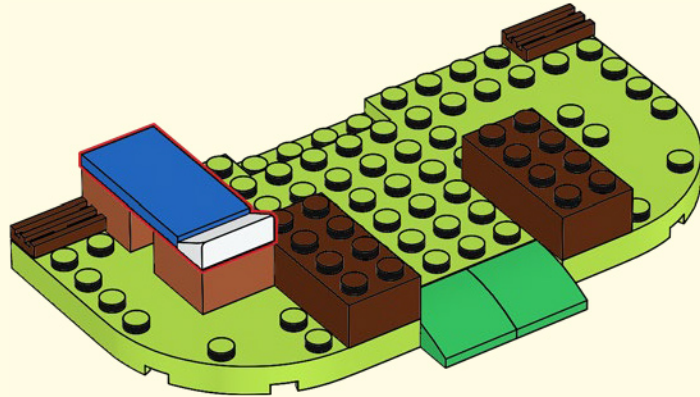

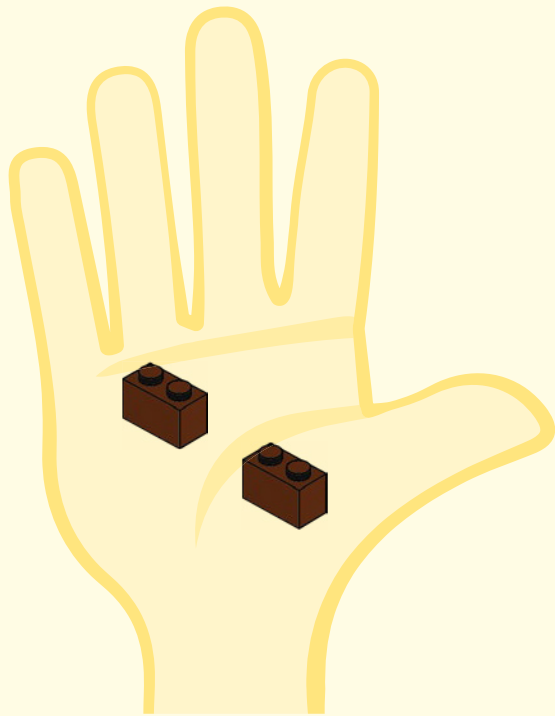
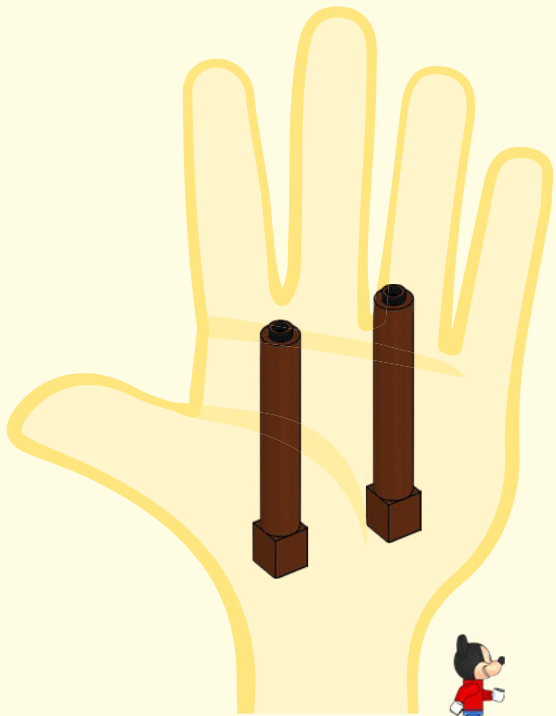

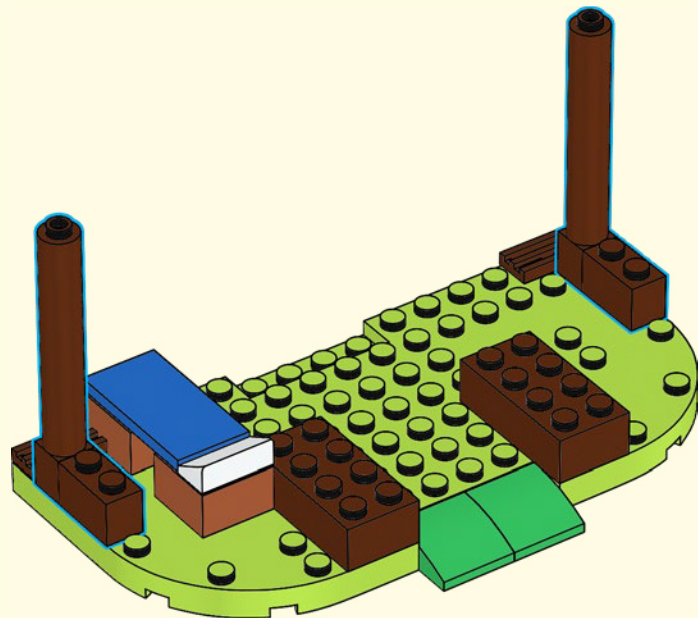

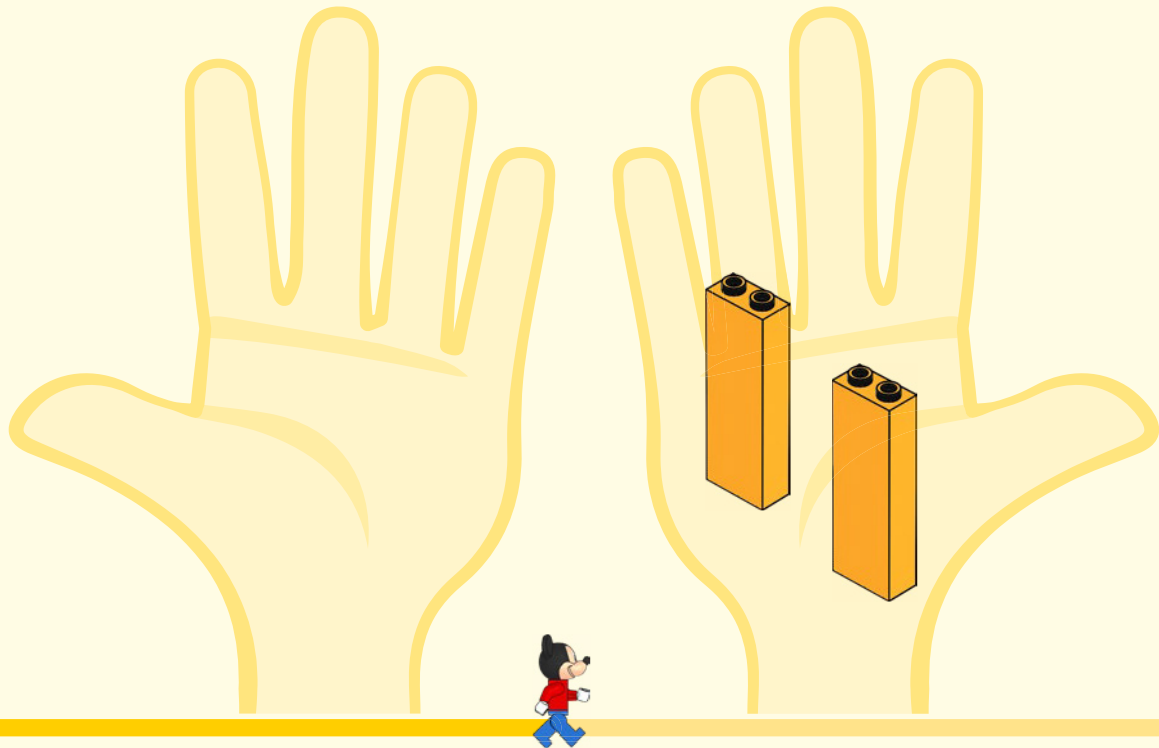

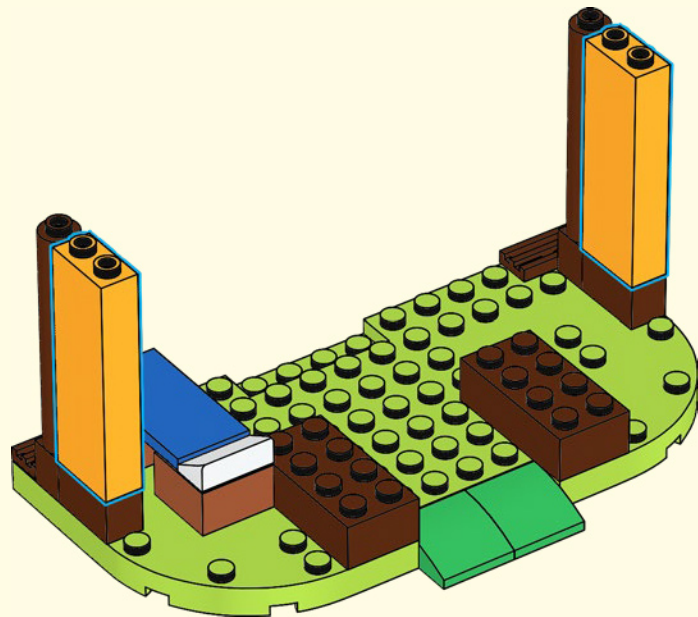

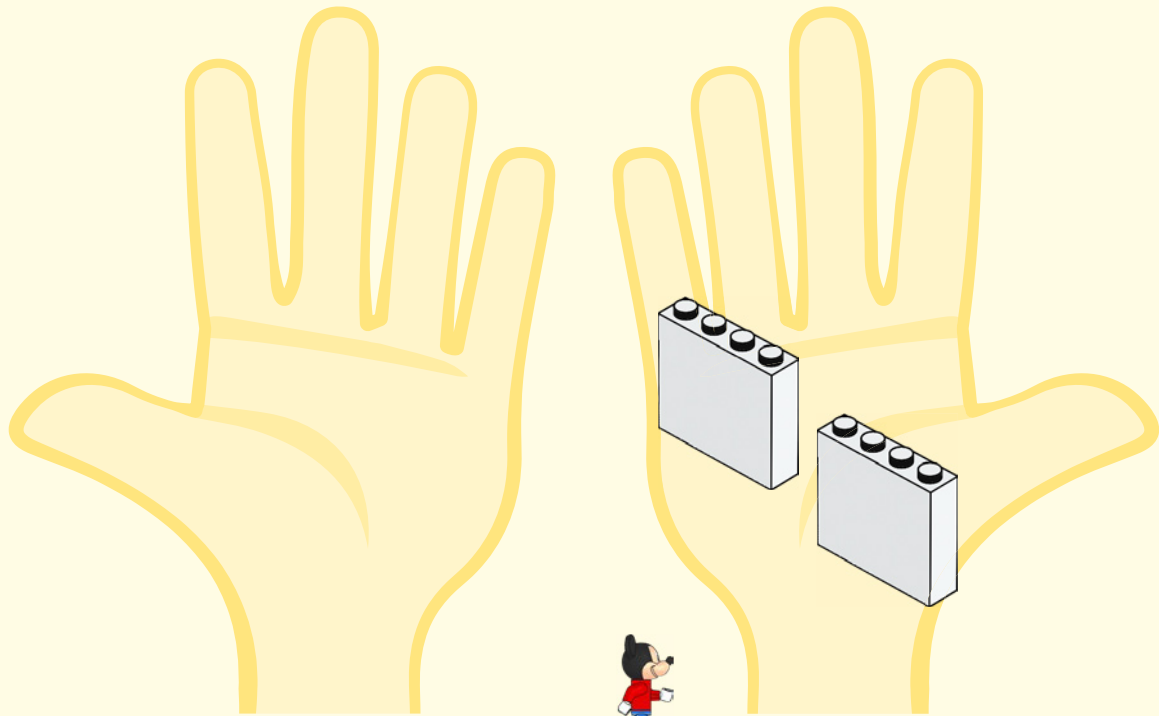

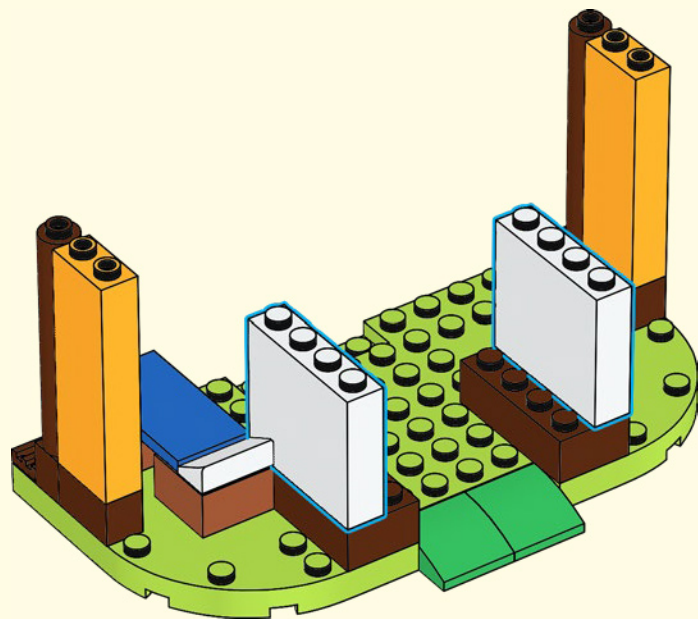



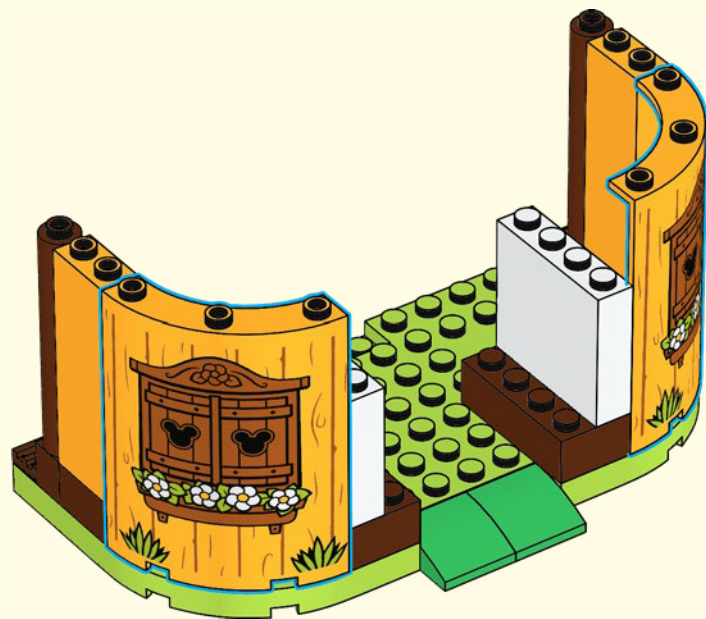

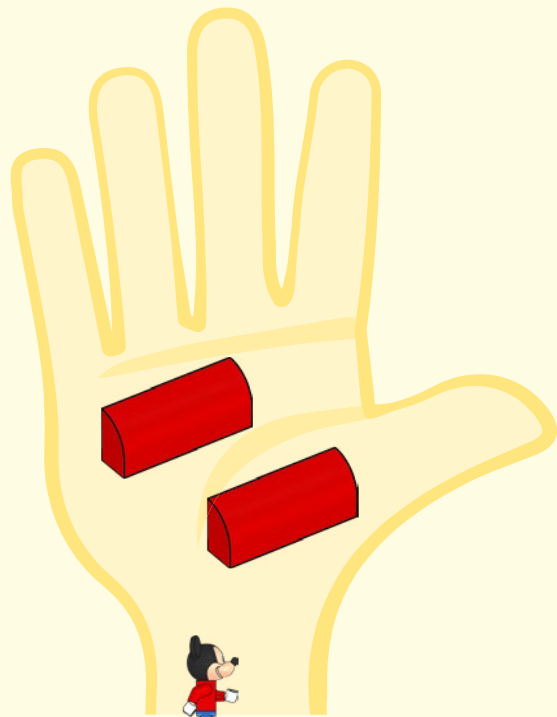

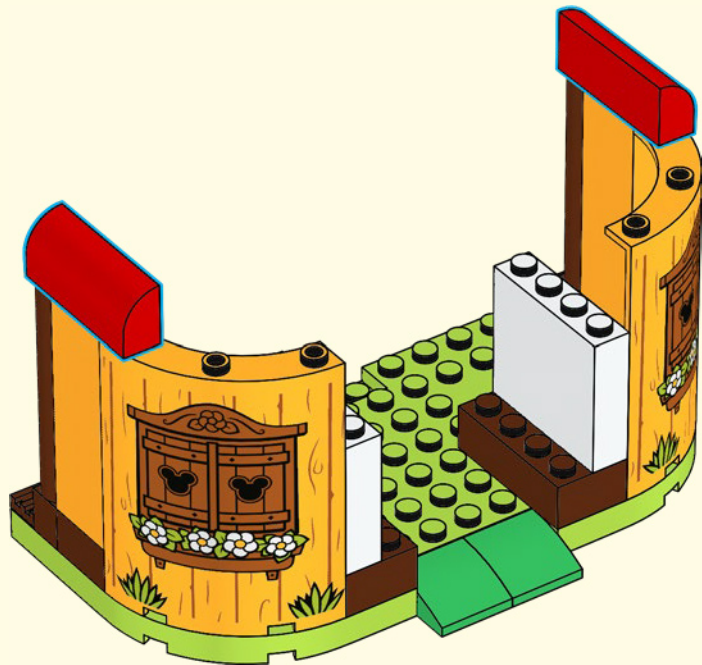

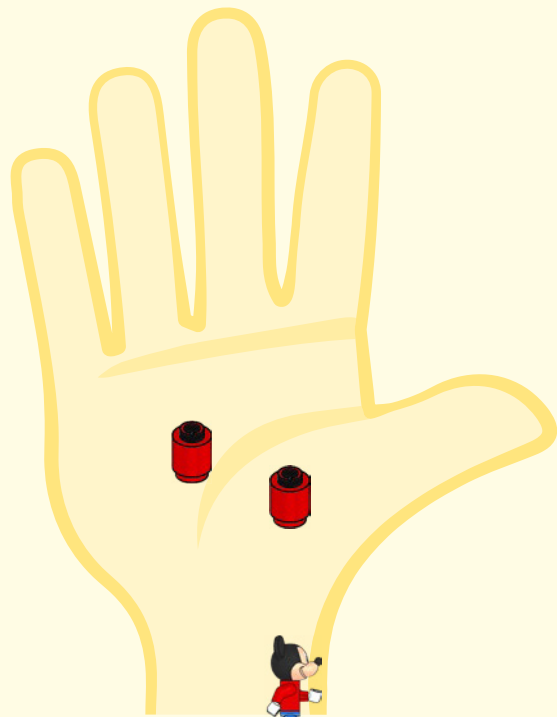

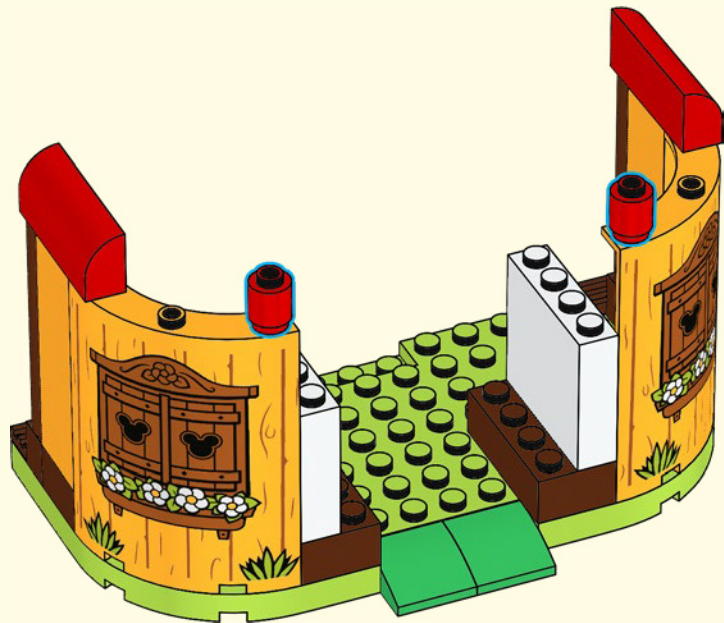

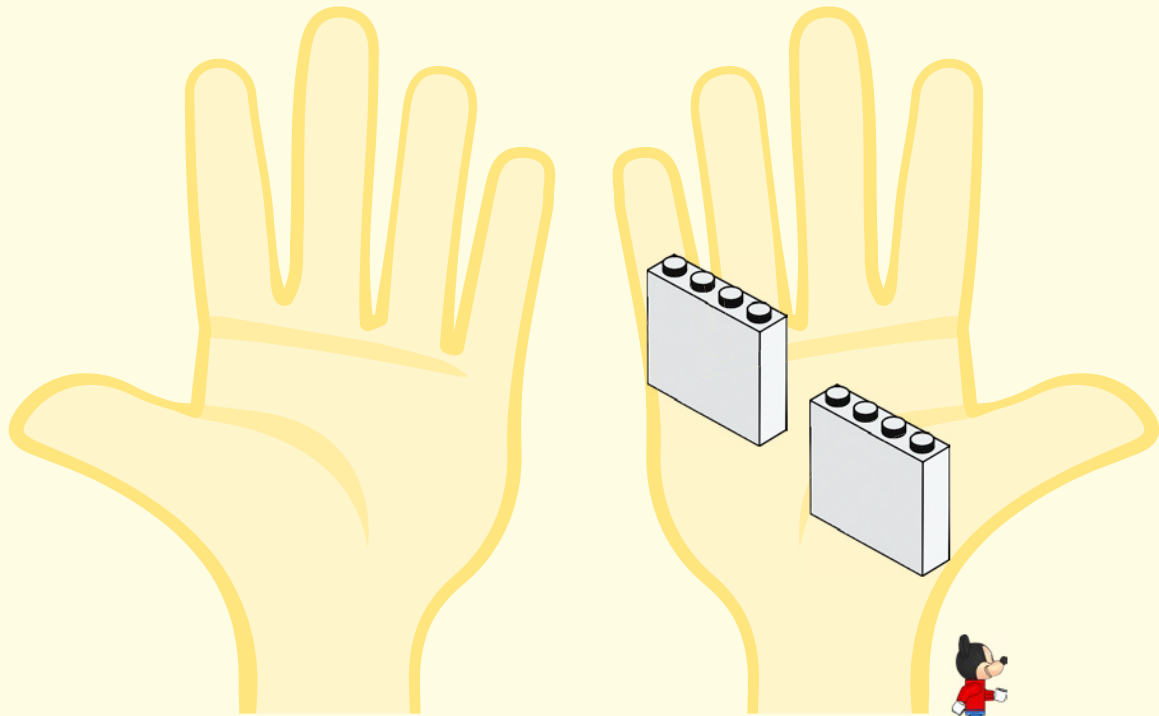

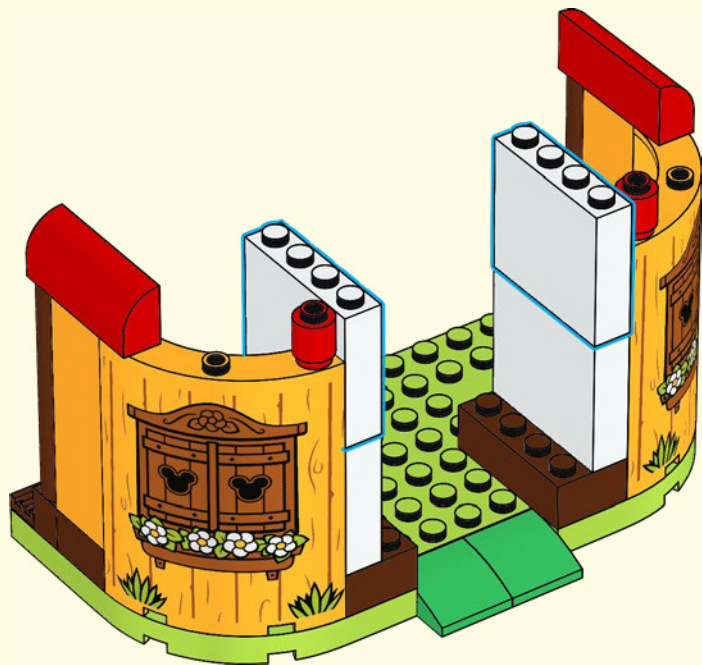



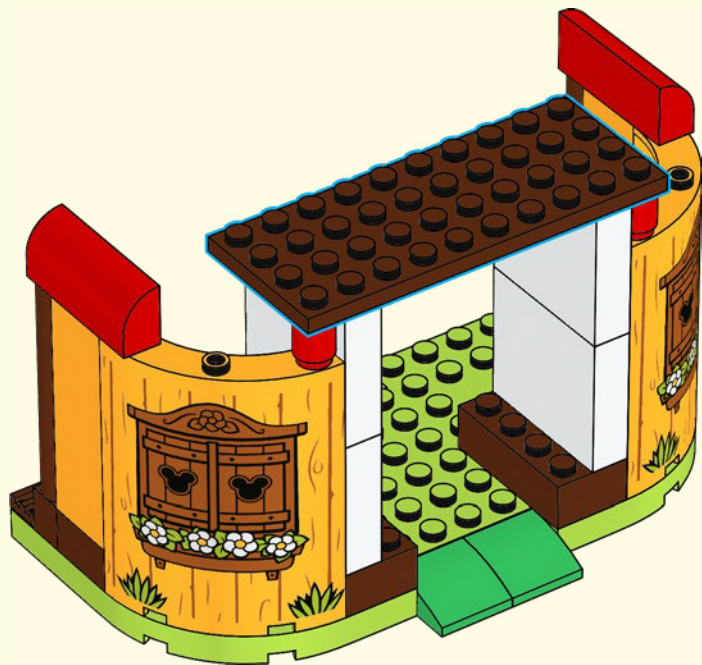

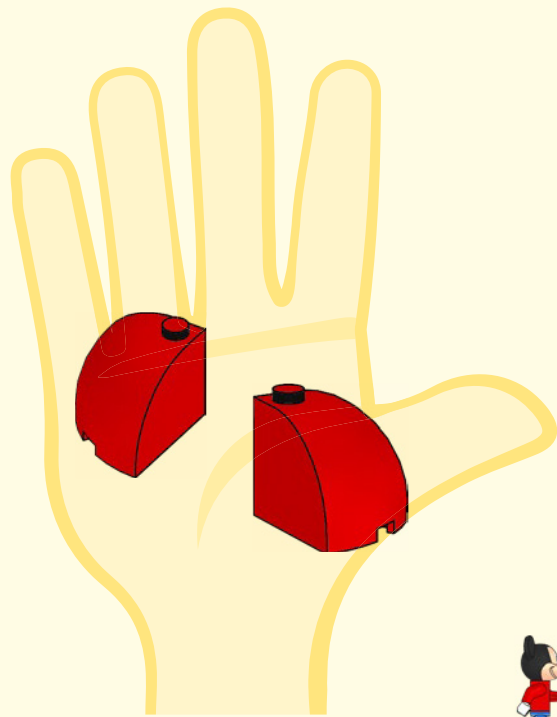

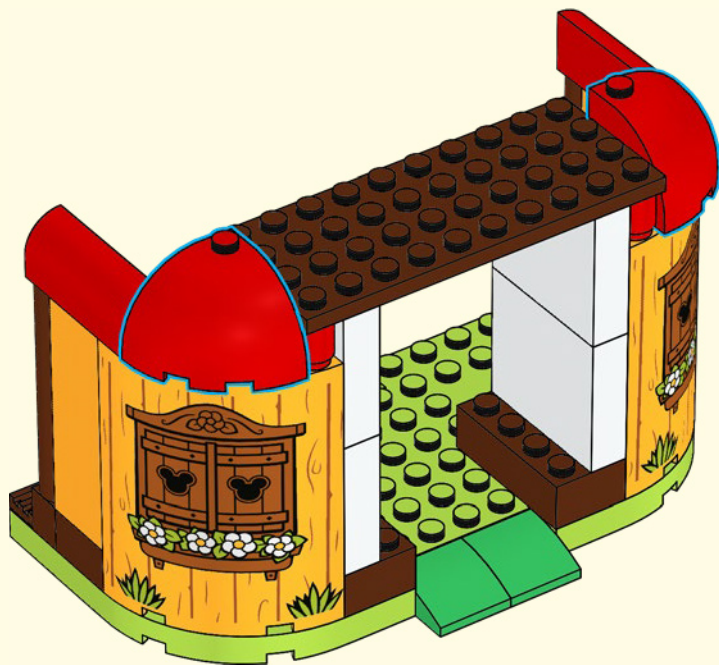

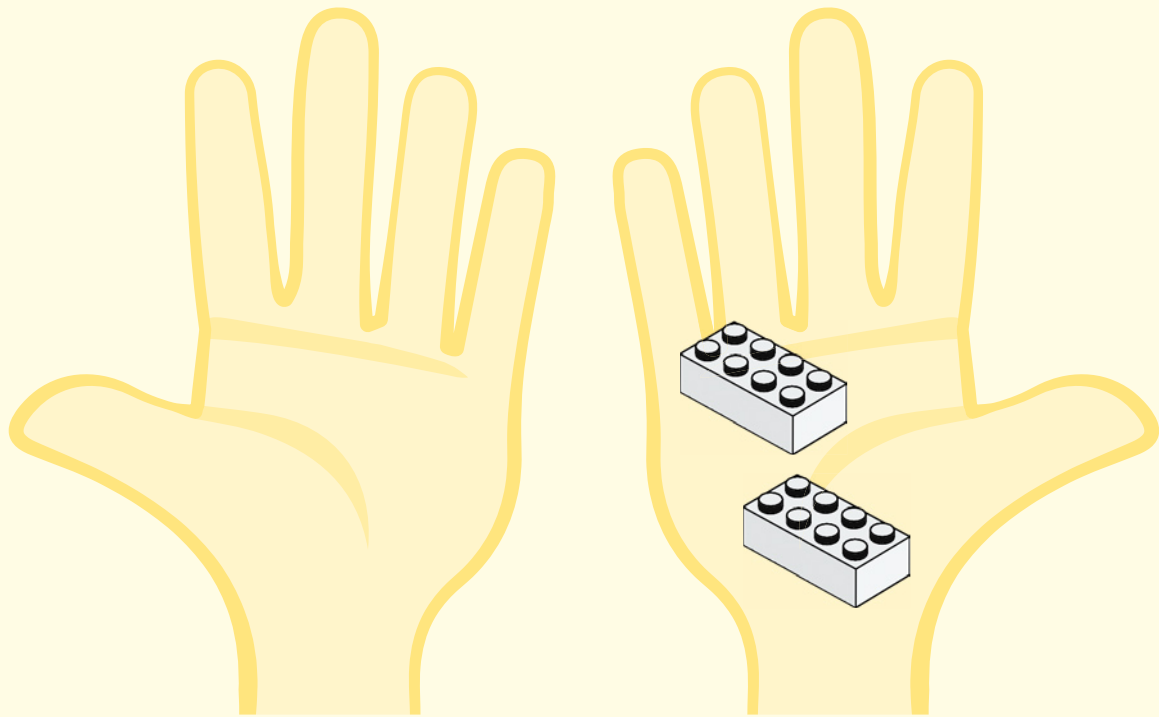

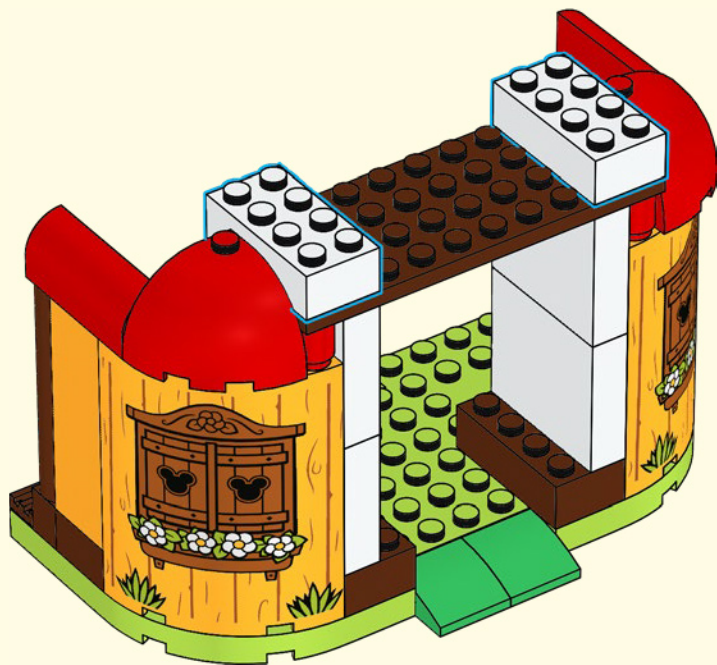

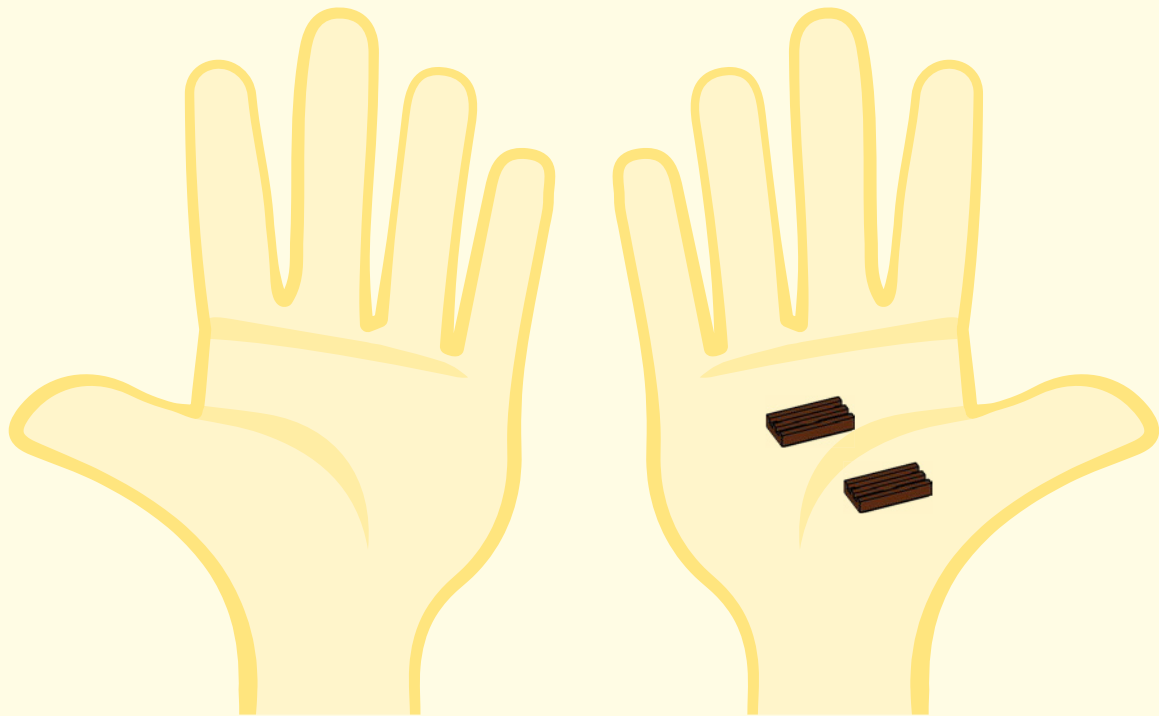

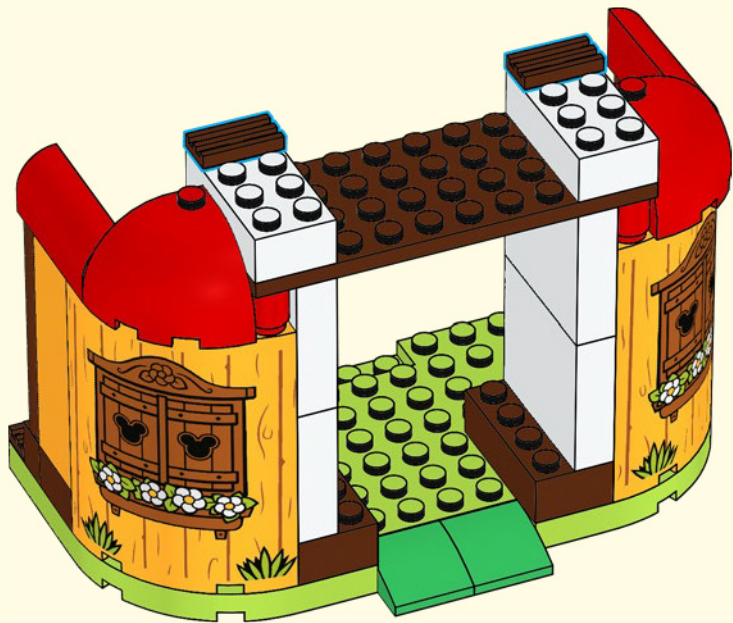

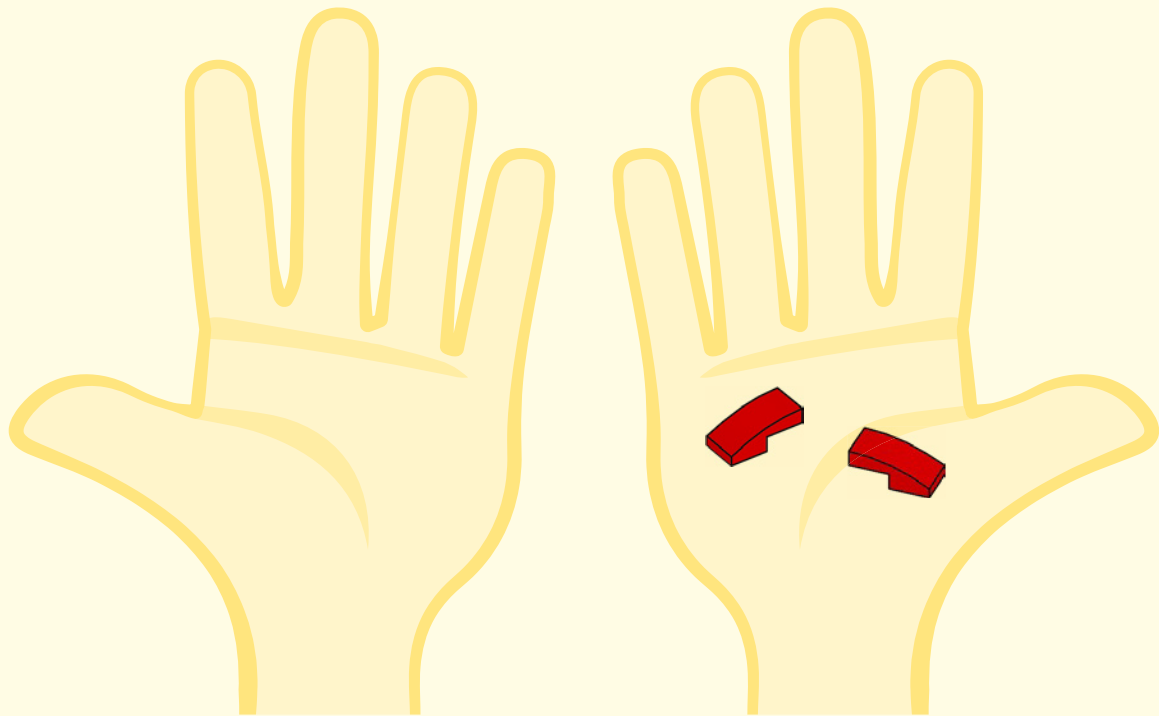

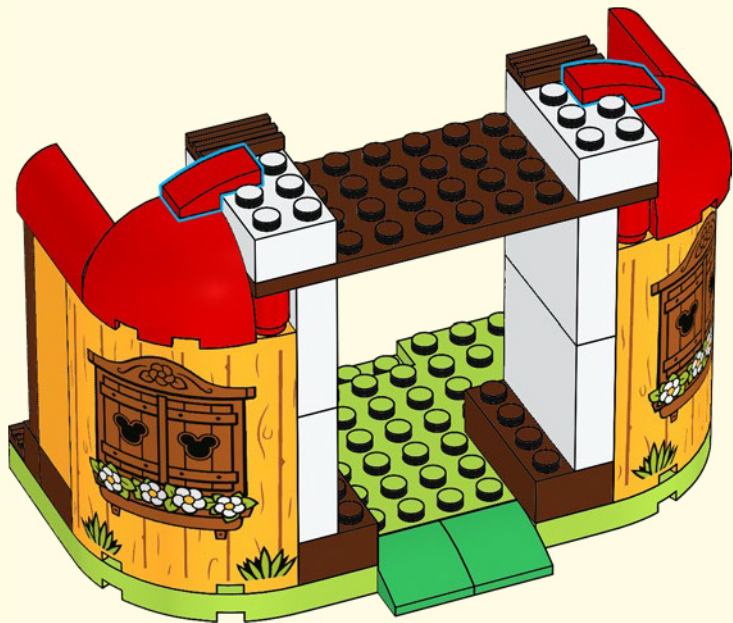

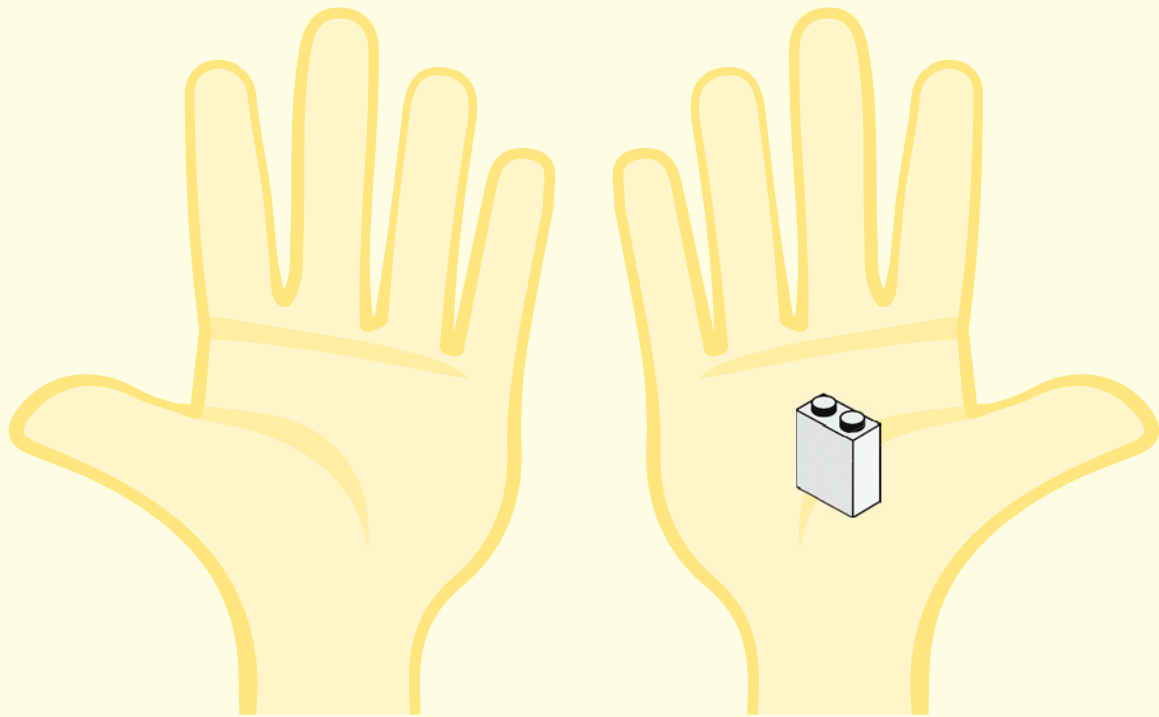

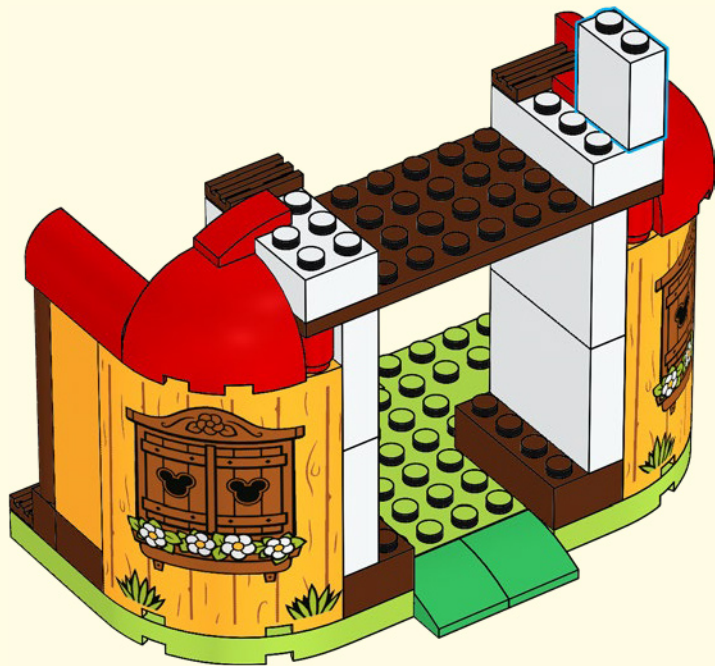

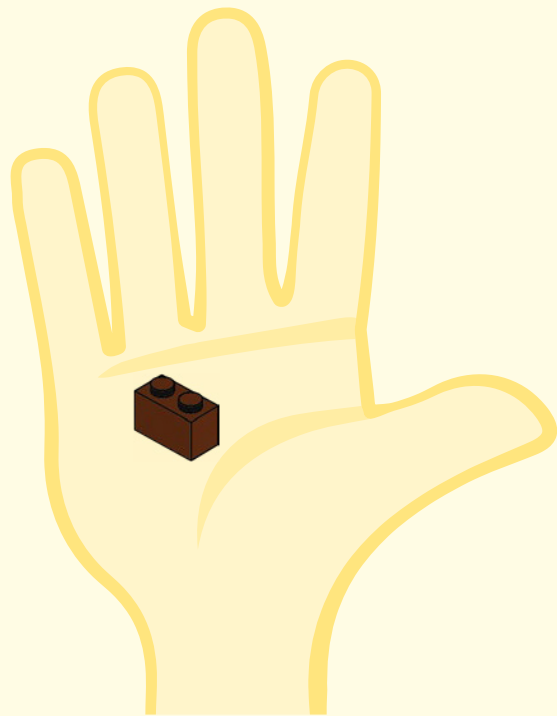
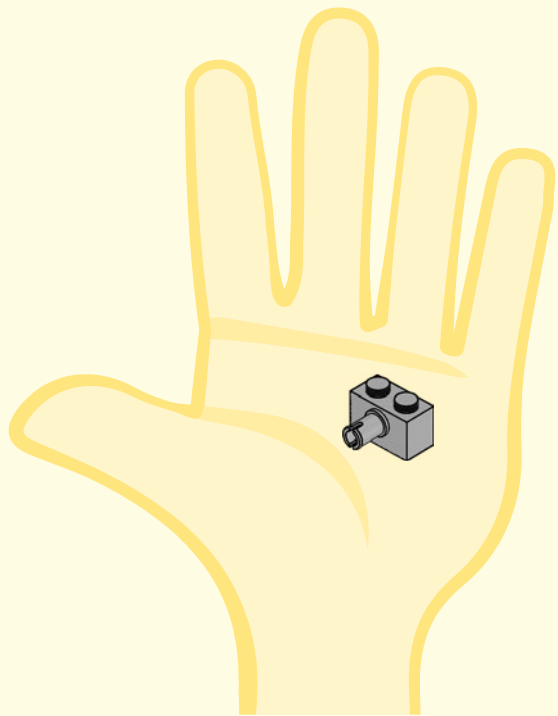

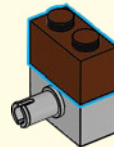
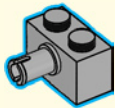

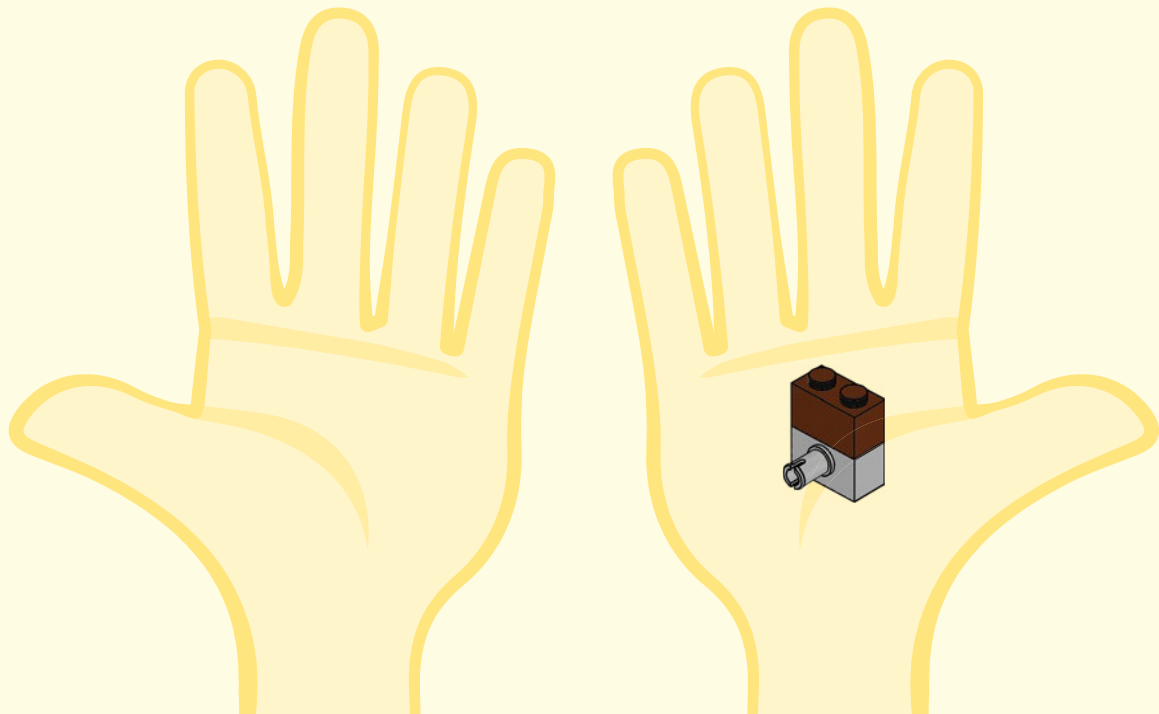

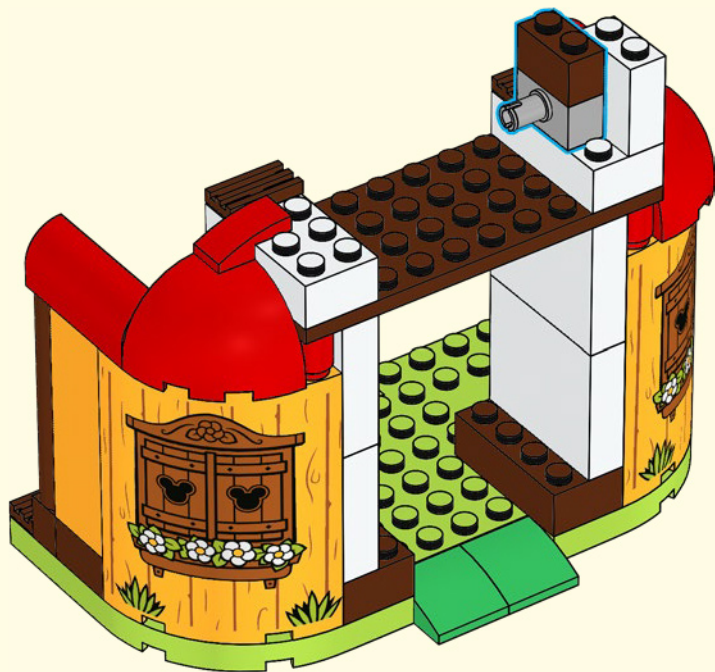

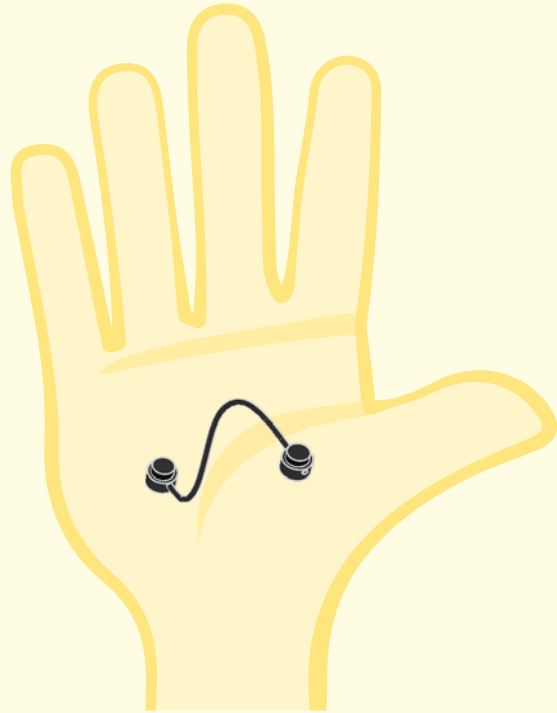
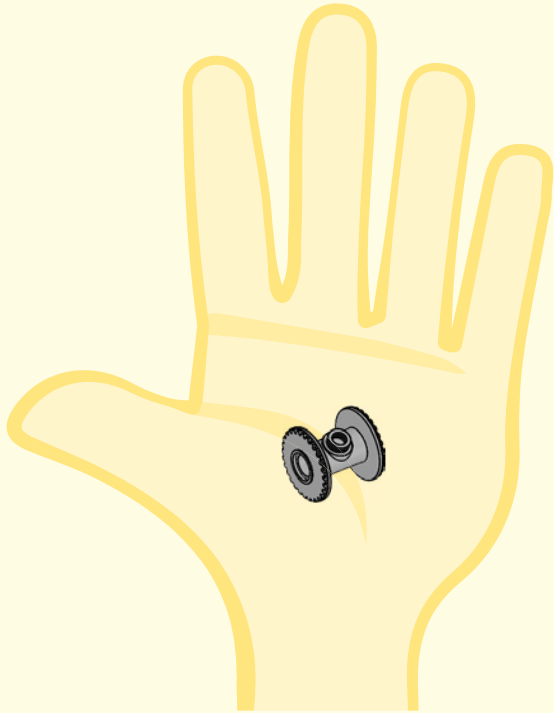

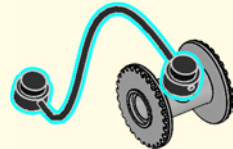

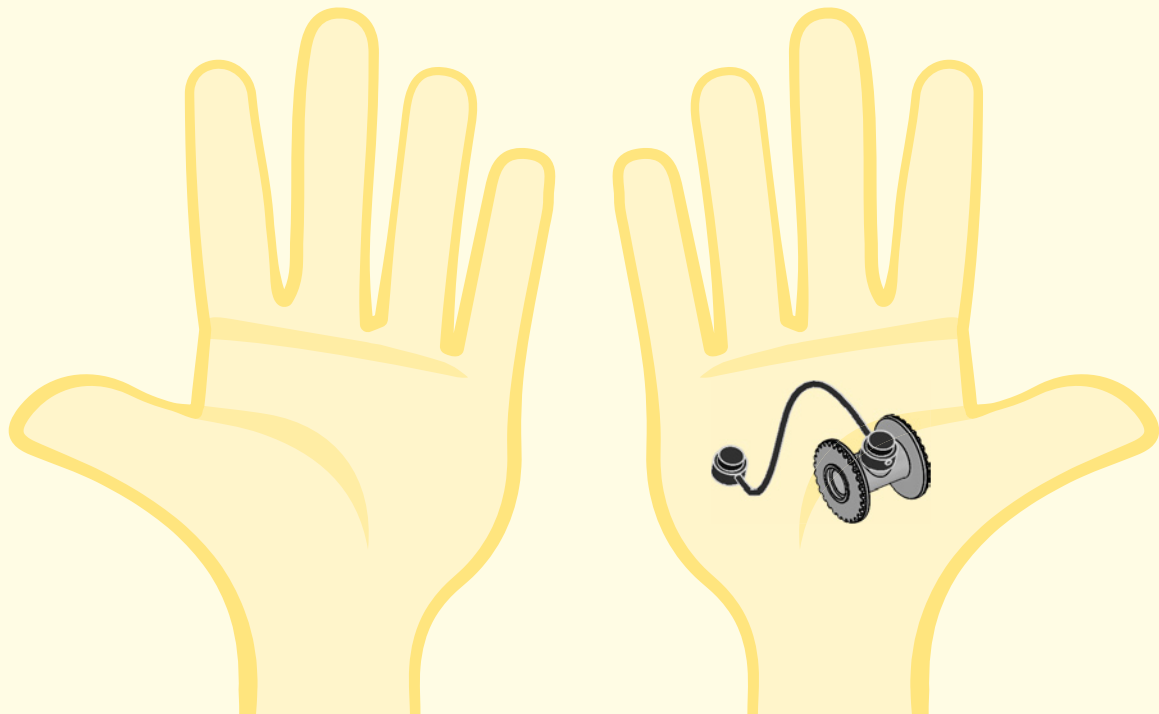

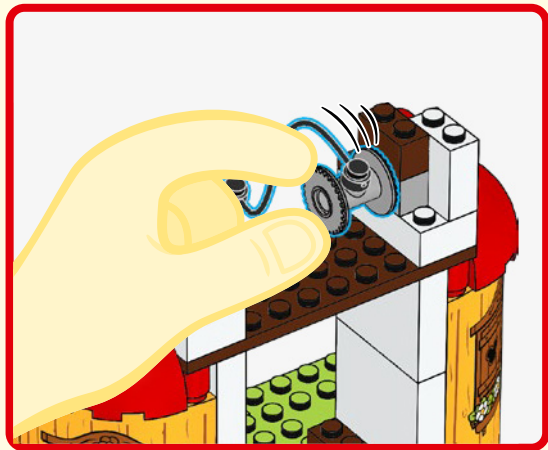
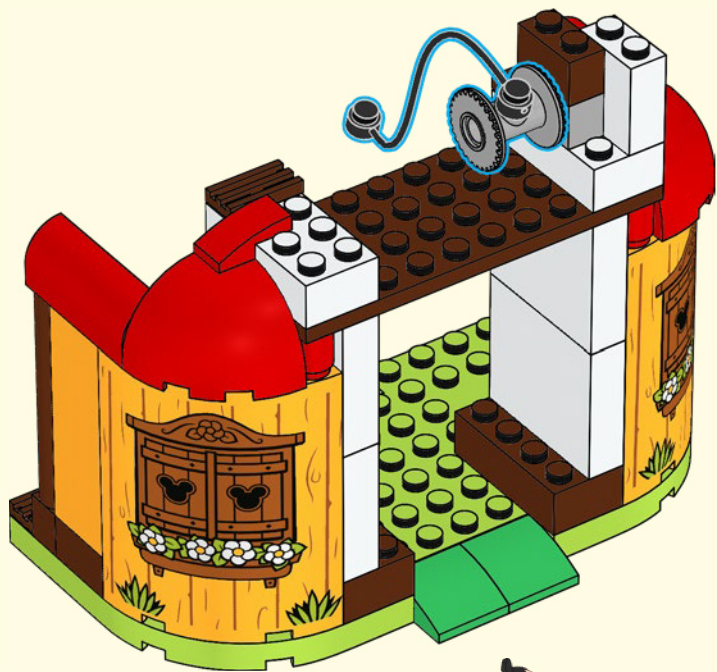

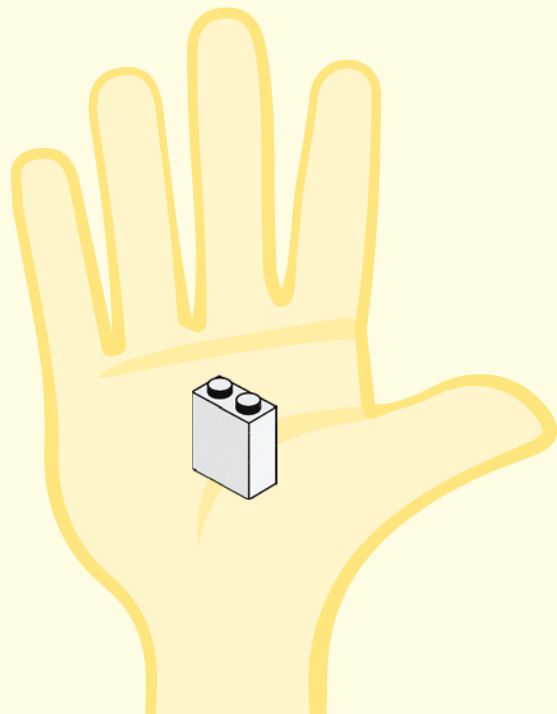
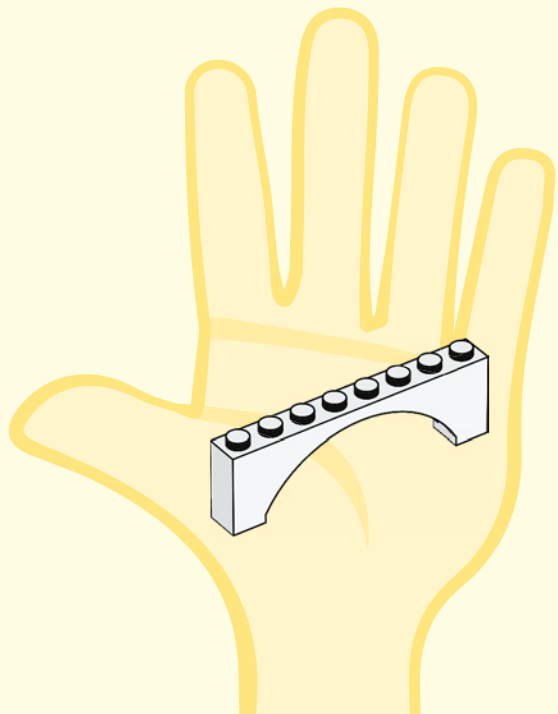

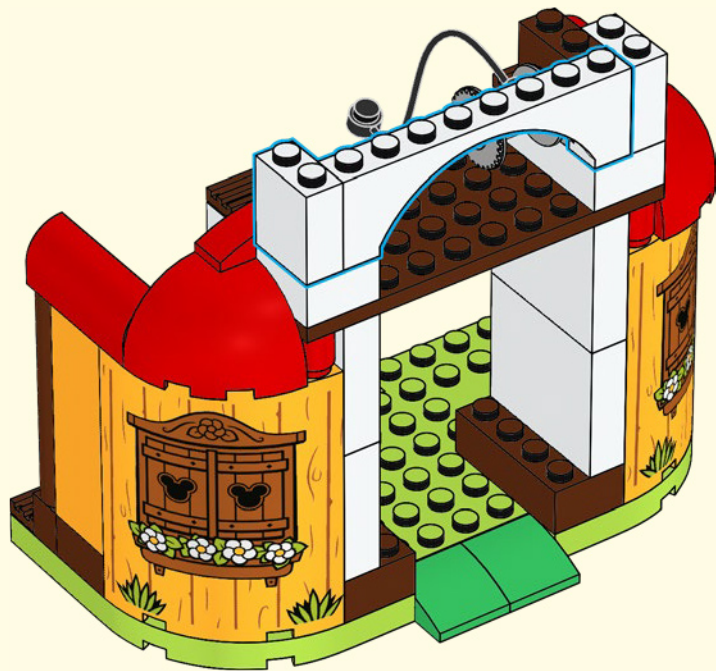

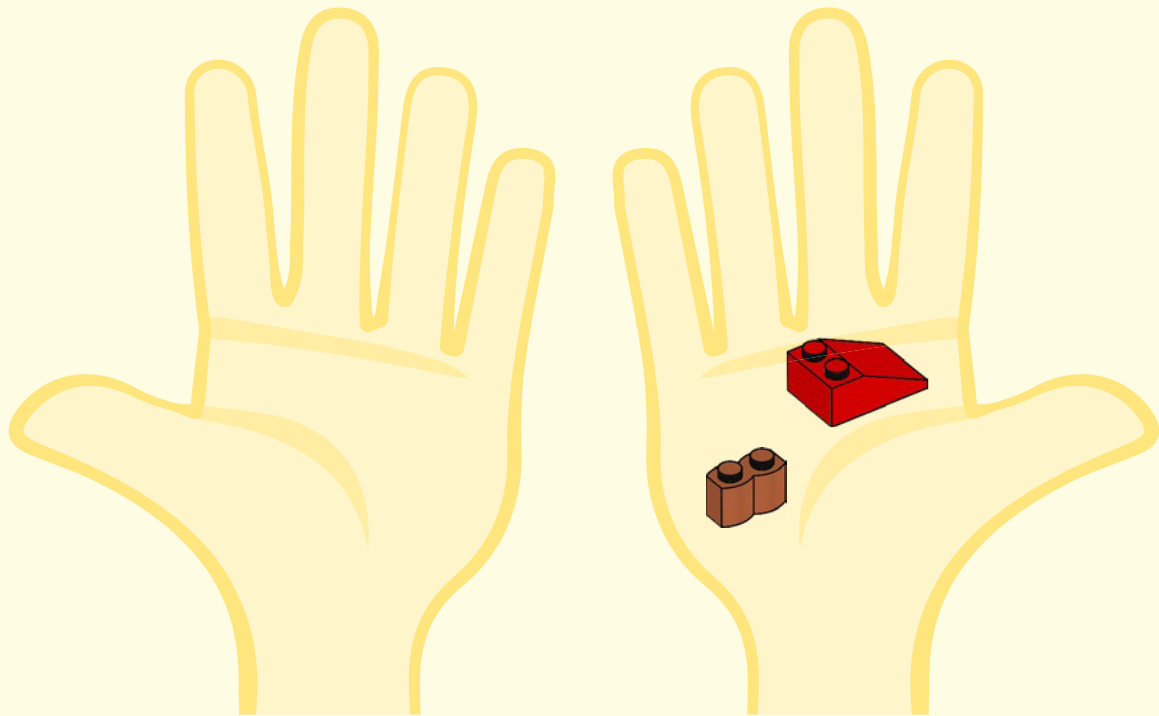

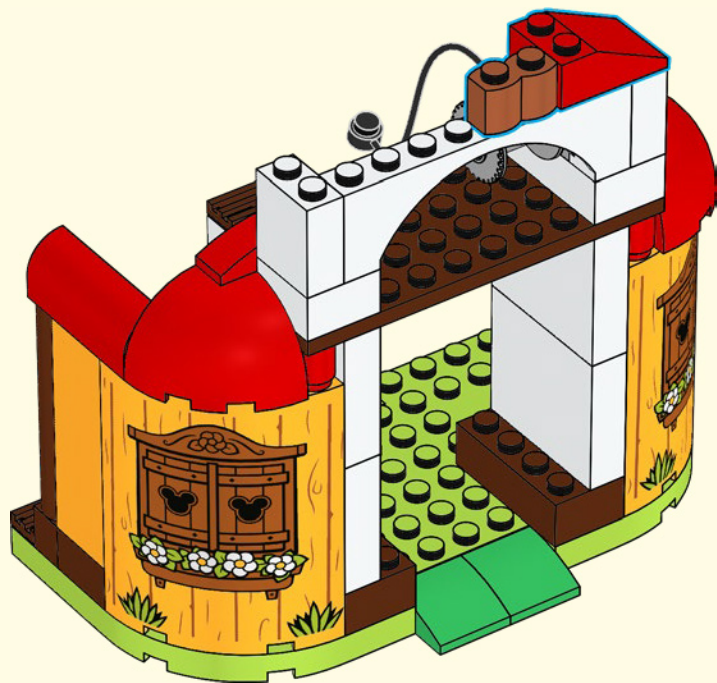

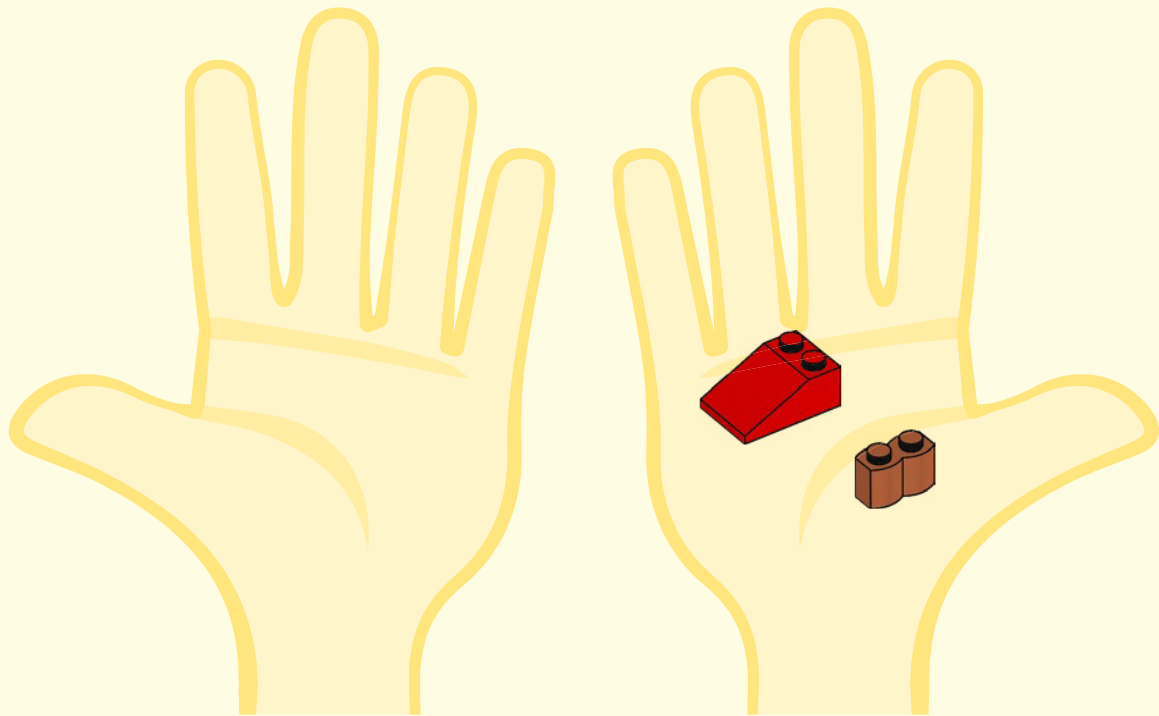

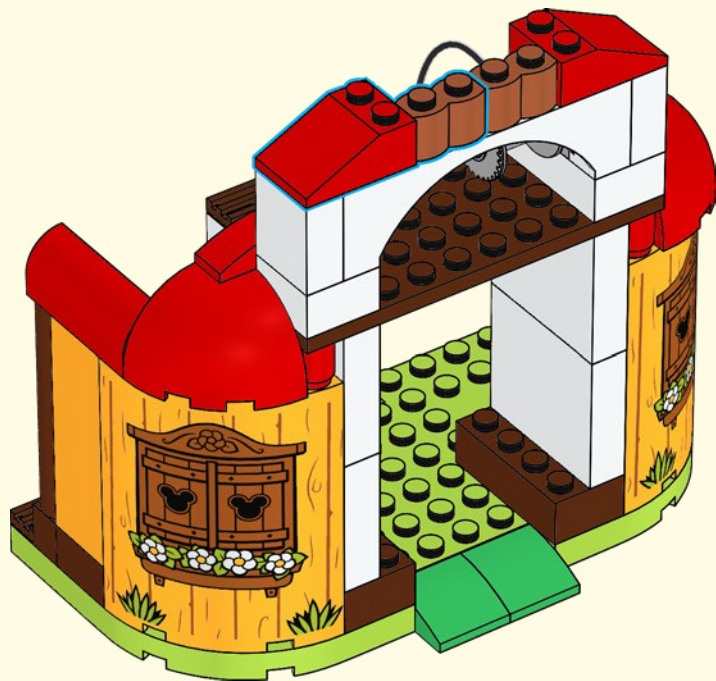

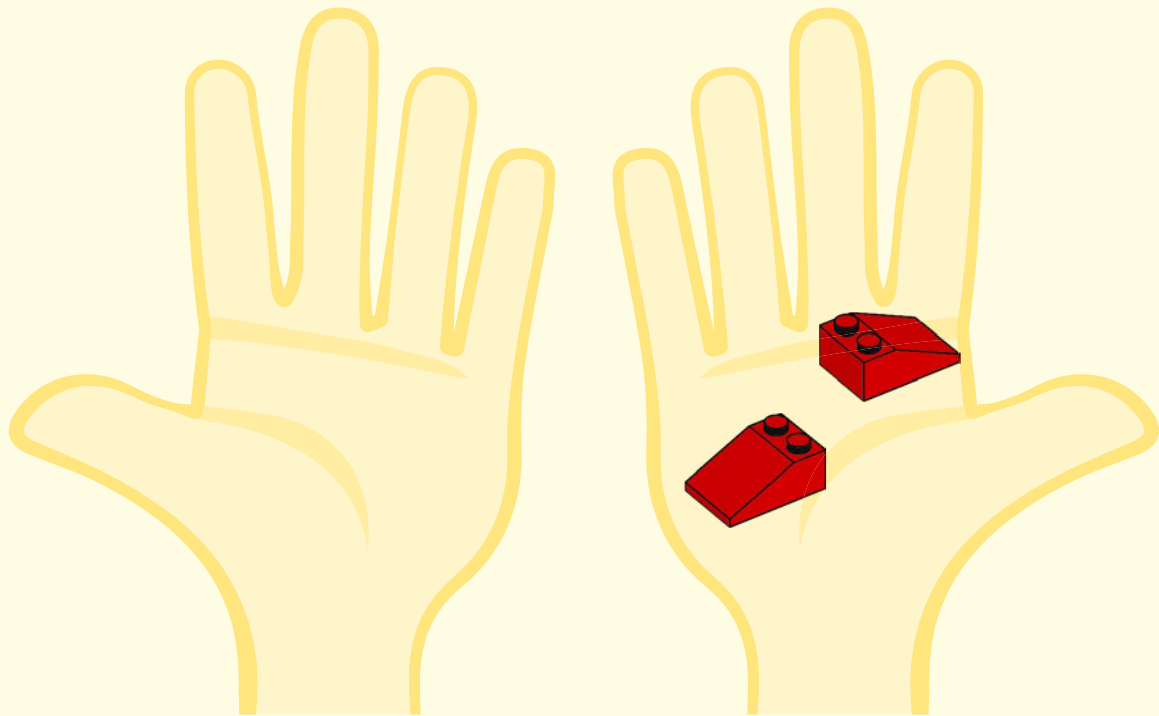

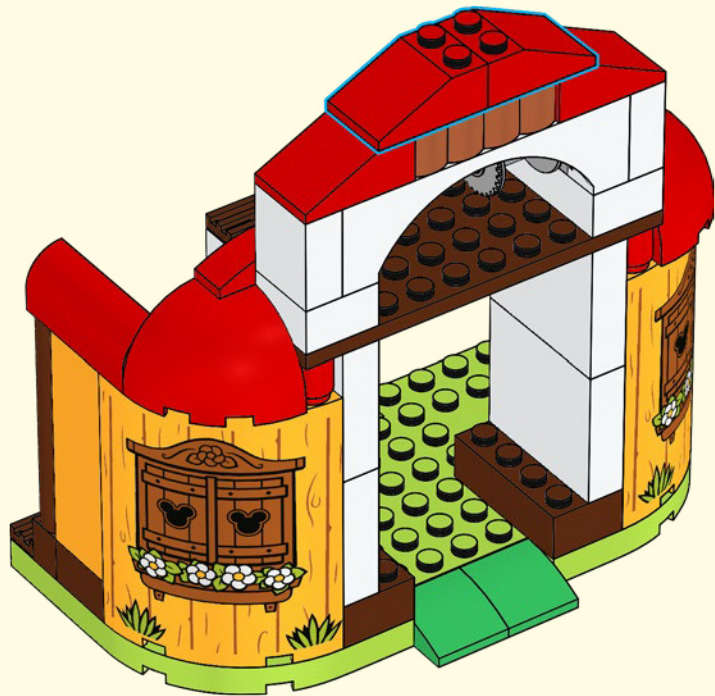

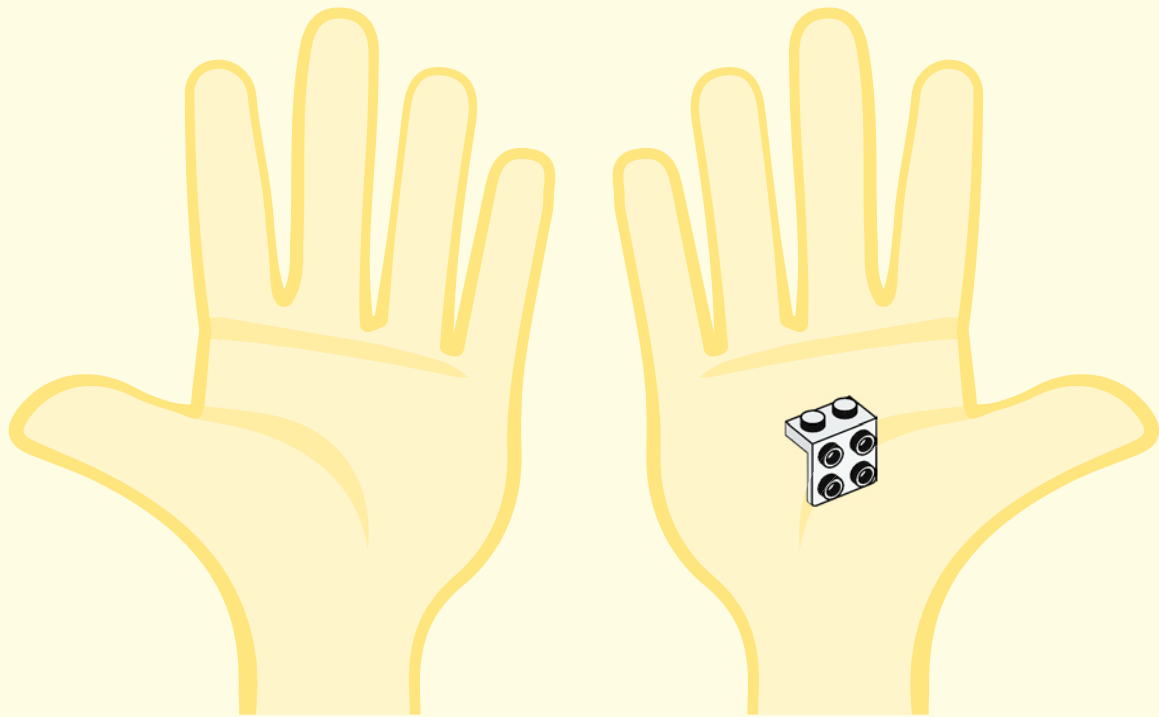

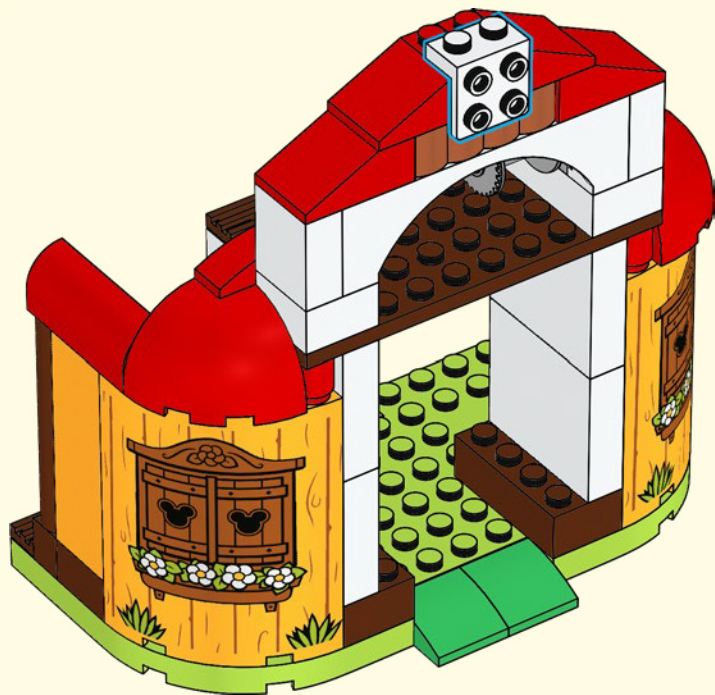

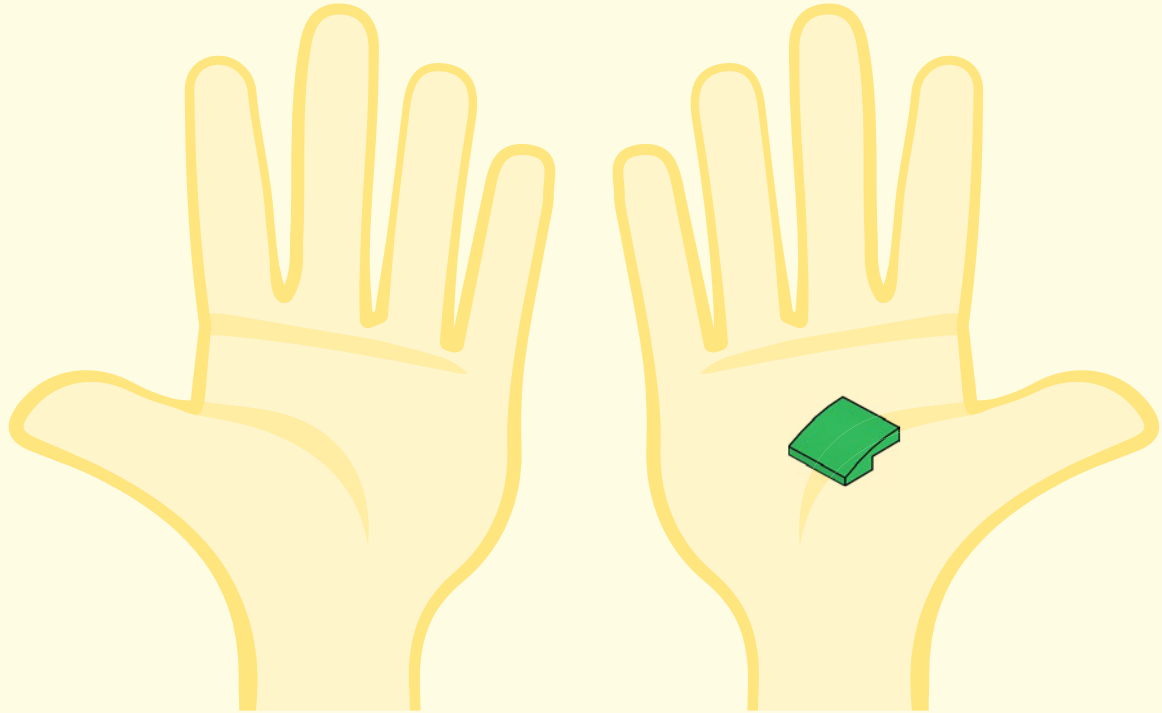

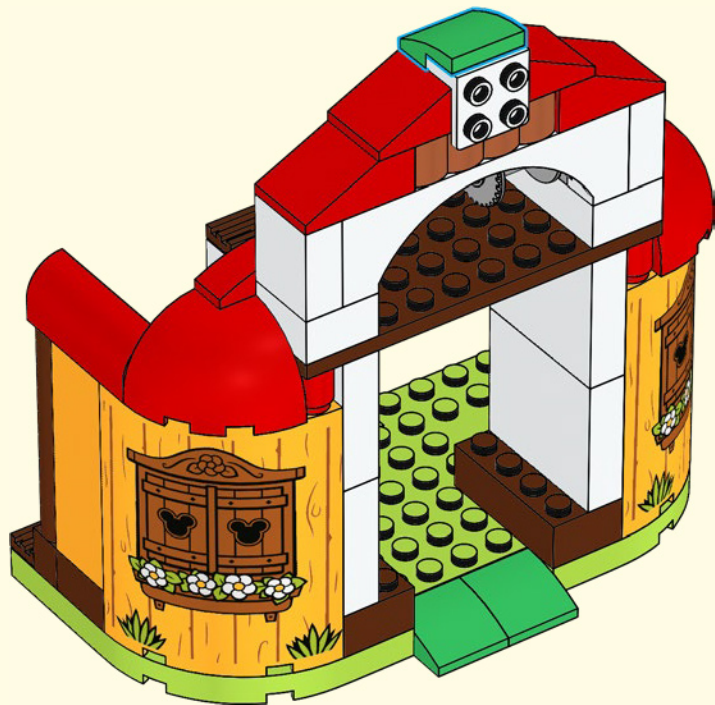

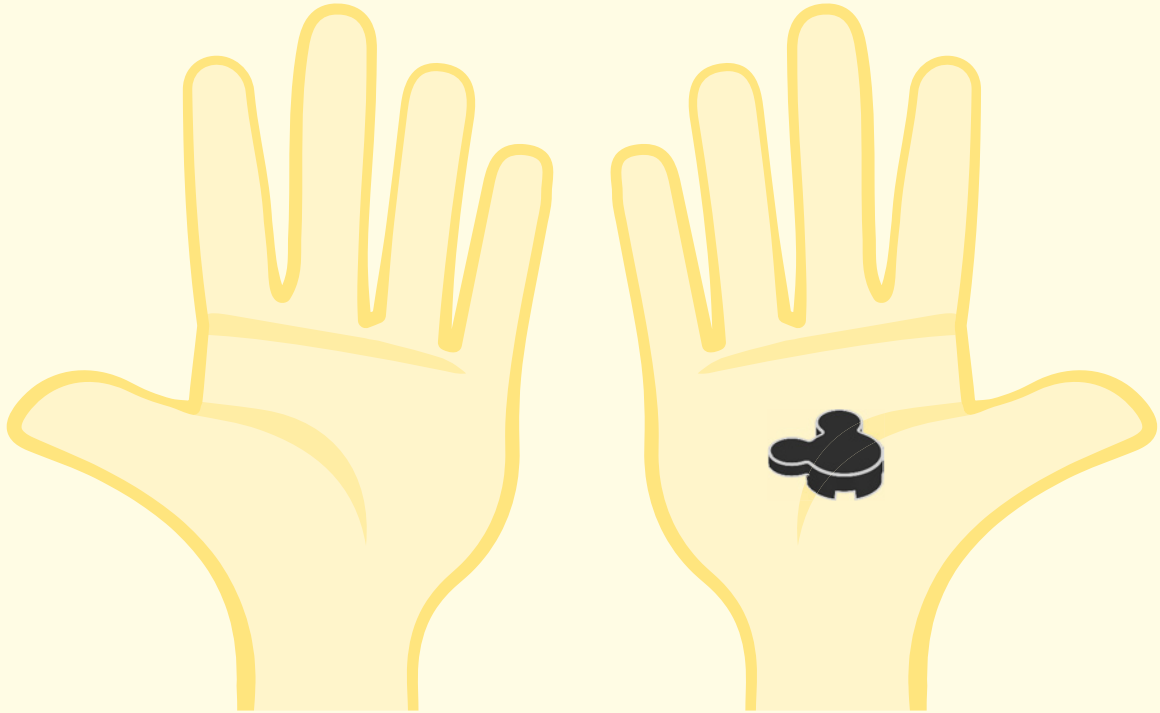

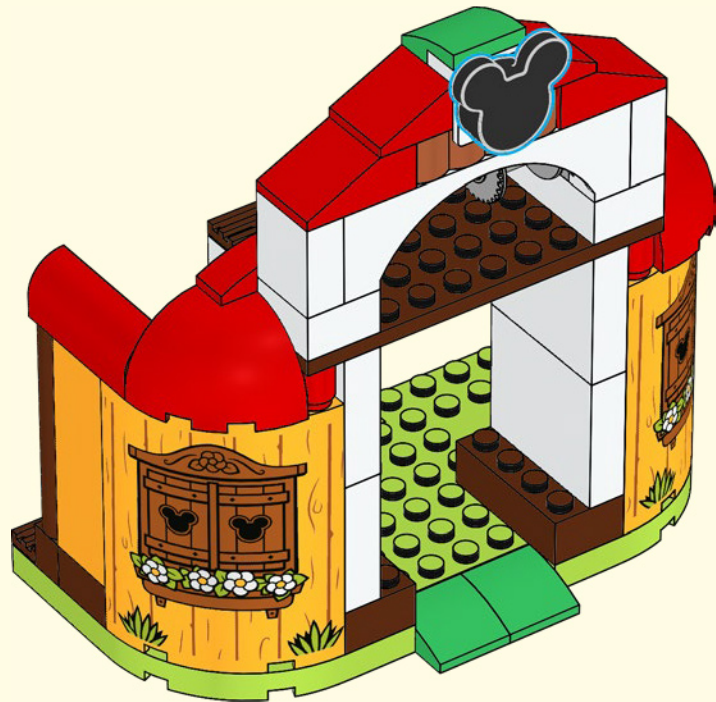

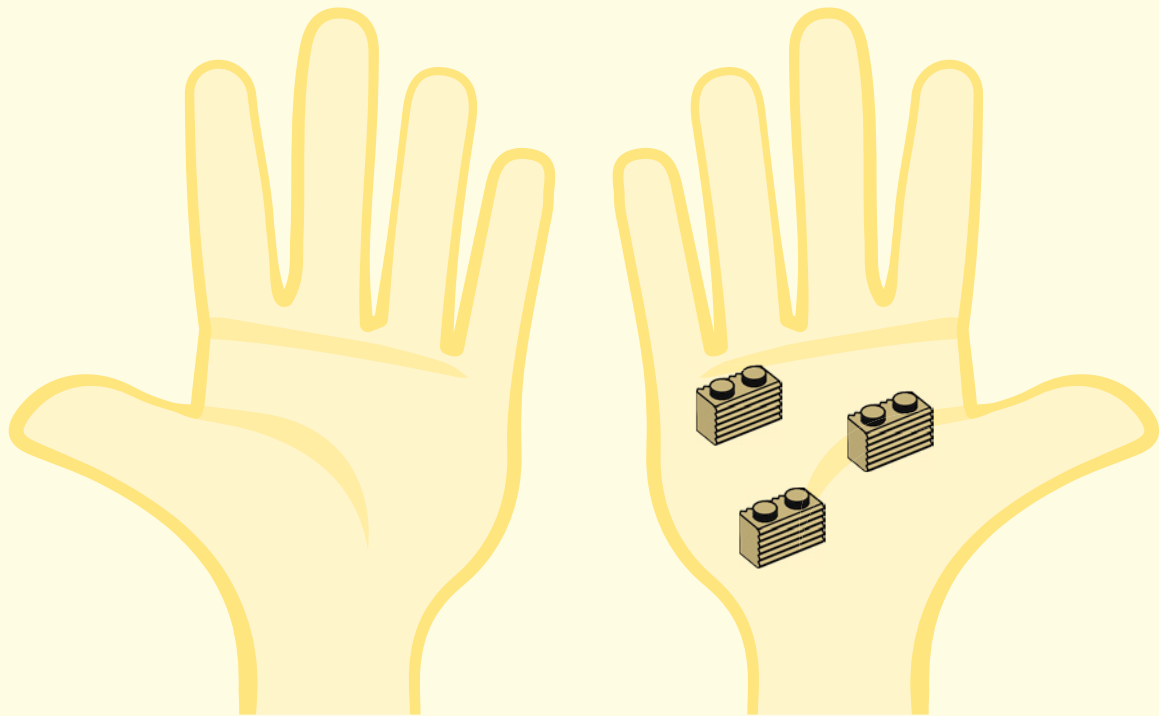

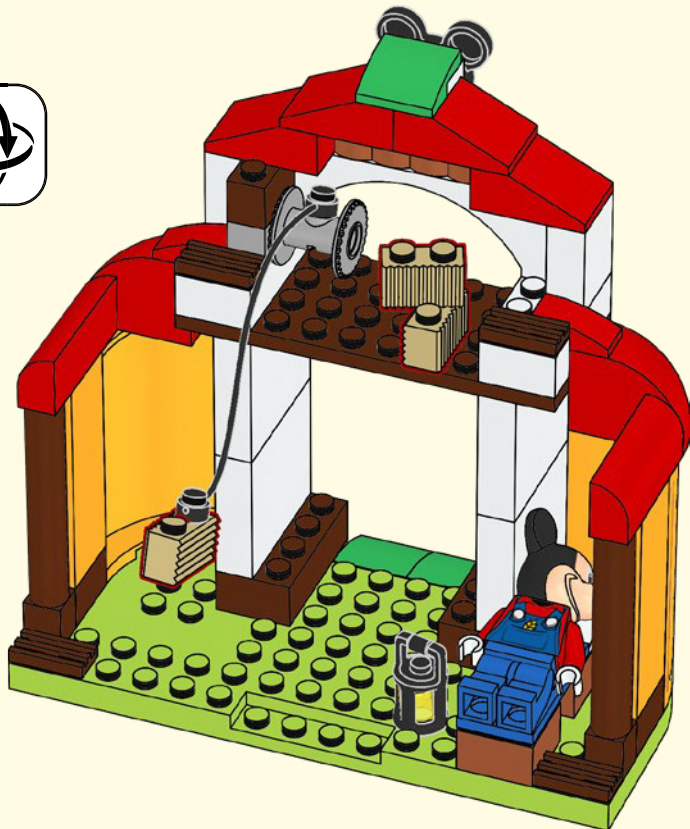

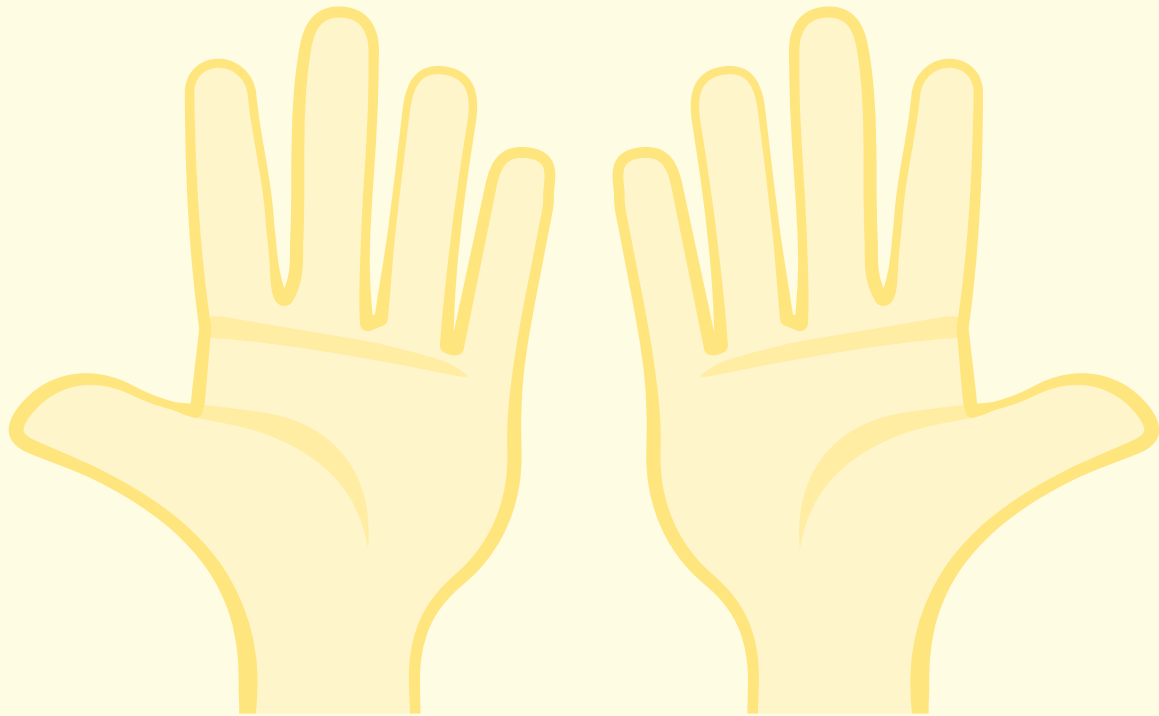

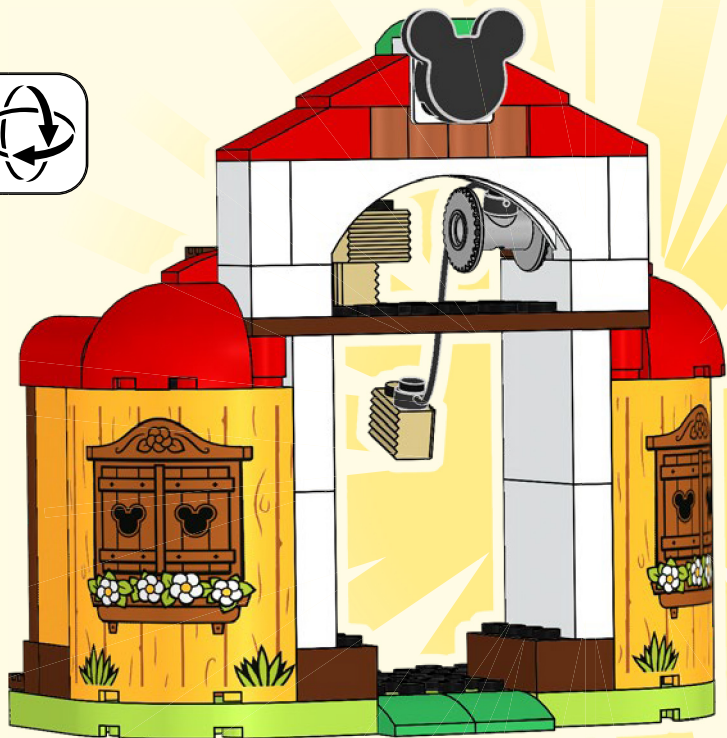

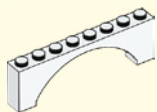

1x
6313647



1x
6254176



1x
6063275



1x
4547489



1x
6143555



1x
6143604



2x
4113261



1x
6117940

70



1x
6143595



1x
6349205



1x
6349208



2x
4141607



1x
6031098

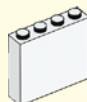

4x
6256922



2x
300101



1x
6342625



3x
4655900



1x
4124456



1x
4109995



1x
6343565



2x
306221



1x
6096955



2x
6029946



2x
4121934



1x
407921



4x
329821



2x
6083618



2x
6334053



1x
6054438



1x
4651524



1x
9341



1x
4560180



3x
4525464



1x
6227901



1x
6271886



1x
249626



1x
6336633



2x
6336638



2x
4619323



1x
6092586



3x
6116259



2x
6270003



1x
6345794



1x
4119479



1x
6238674



2x
6310290

2x
6250319

2x
6038459

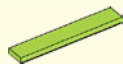
2x
6013530

2x
6167465

1x
6269007

2x
4666352

2x
6212081

2x
6343886



2x
6342613

2x
4520612

4x
4224243

1x
6172808

3x
4211149

1x
4211151

3x
4211201

2x
4221590

1x
6270119

1x
6103249

1x
4529241



1x
4211383



1x
6321770



1x
4226995

1x
6343889

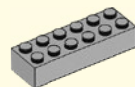

2x
6109684



1x
4211394

1x
4211795

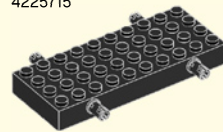
1x
6172316

1x
4225715

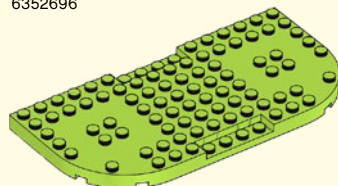
1x
6352696

1x
6336632

Customer Service
Kundenservice
Service Consommateurs
Servicio Al Consumidor
LEGO.com/service or dial

: 00800 5346 5555
: 1-800-422-5346



Disney

 ©Disney
www.disney.com

LEGO and the LEGO logo are trademarks of the LEGO Group.
©2021 The LEGO Group. 6370277



10776



10774



10772



10775



10773



Disney
MICKEY
AND FRIENDS





Disney

10775





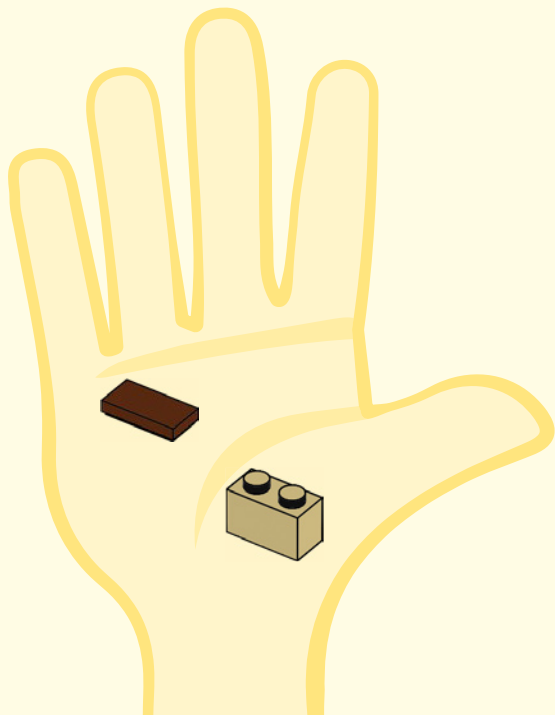
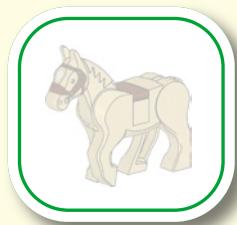

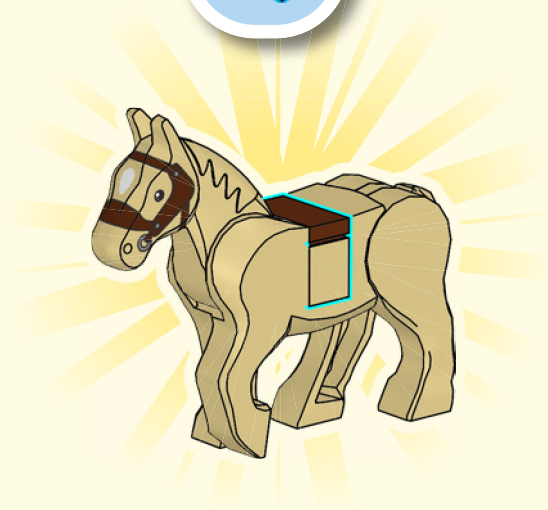
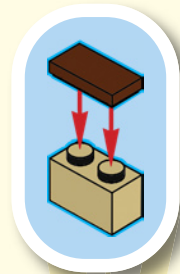
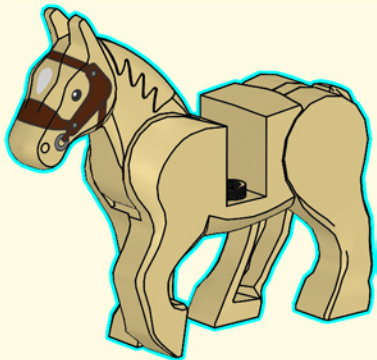

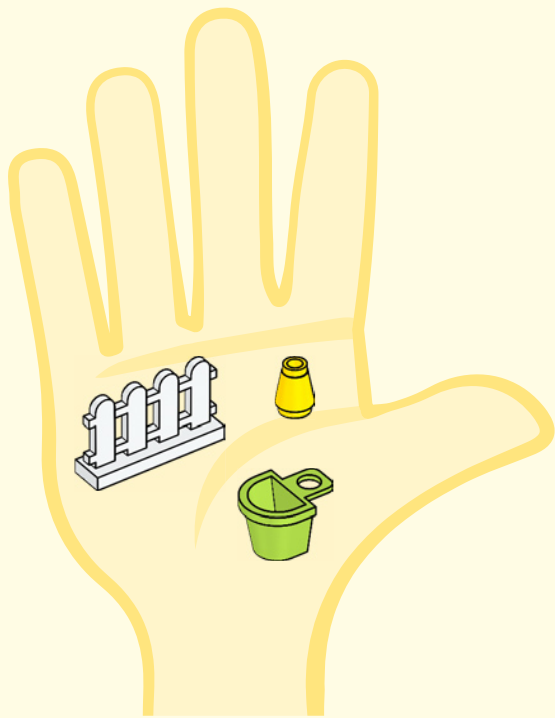
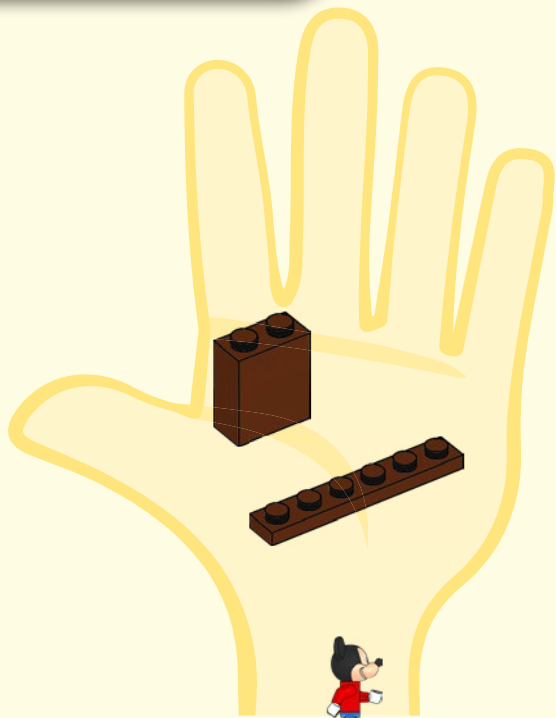

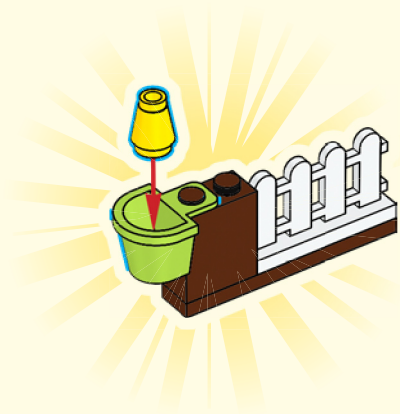
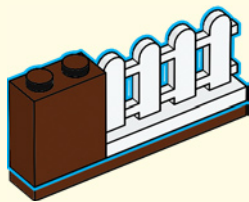
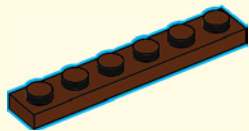

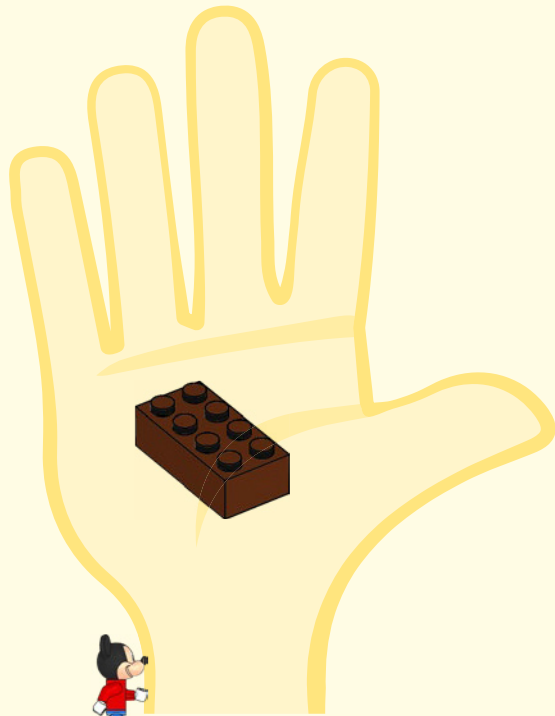
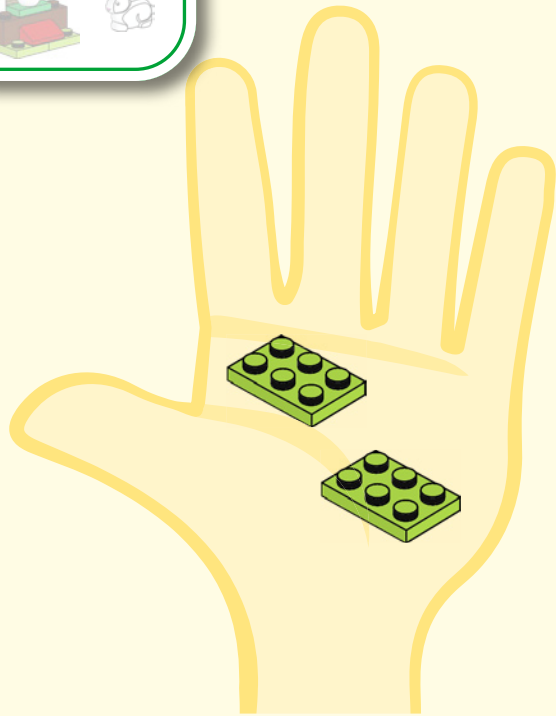
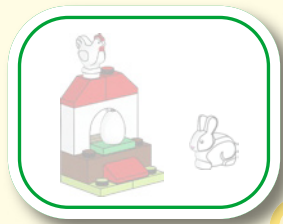

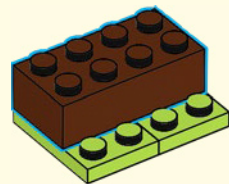
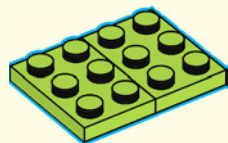

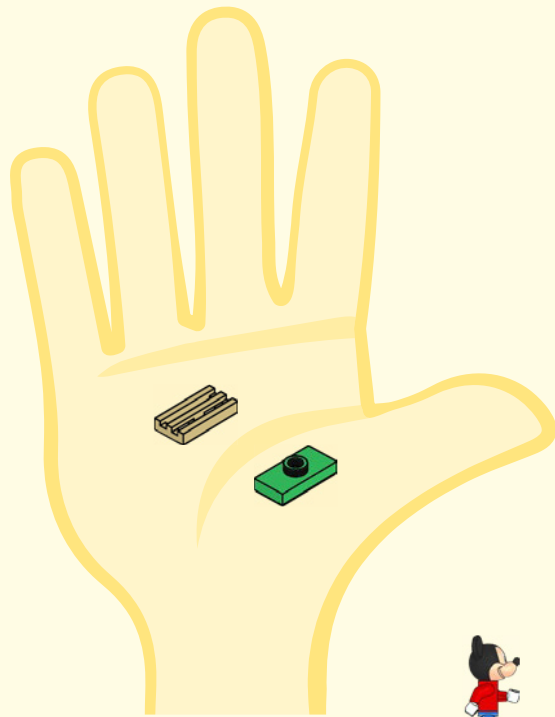
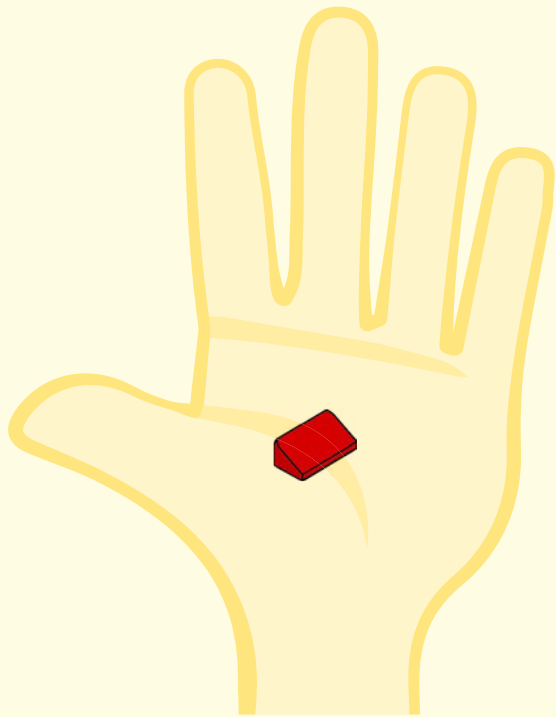

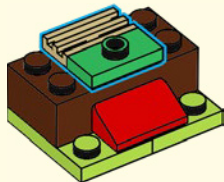
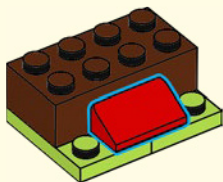

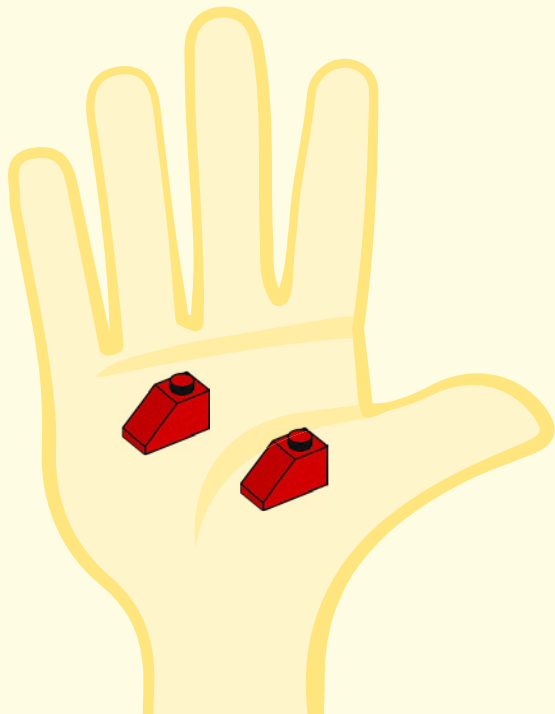
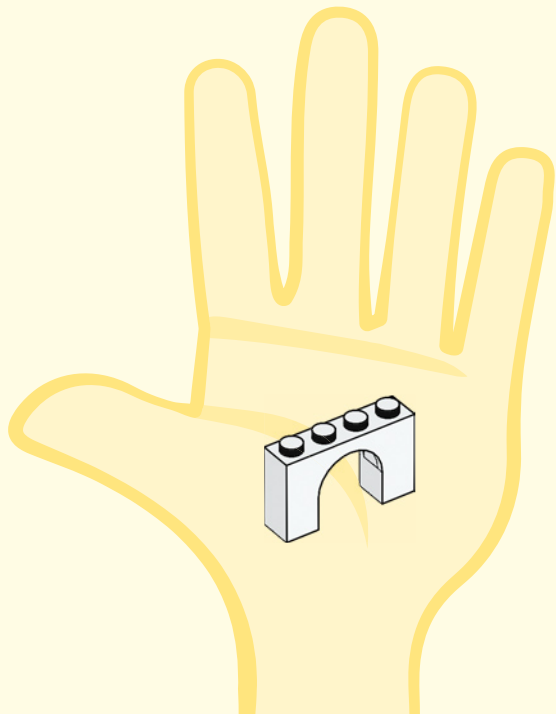

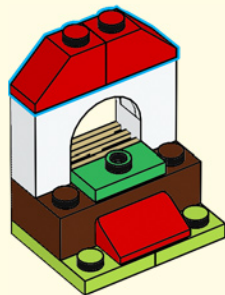
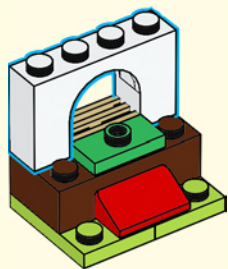

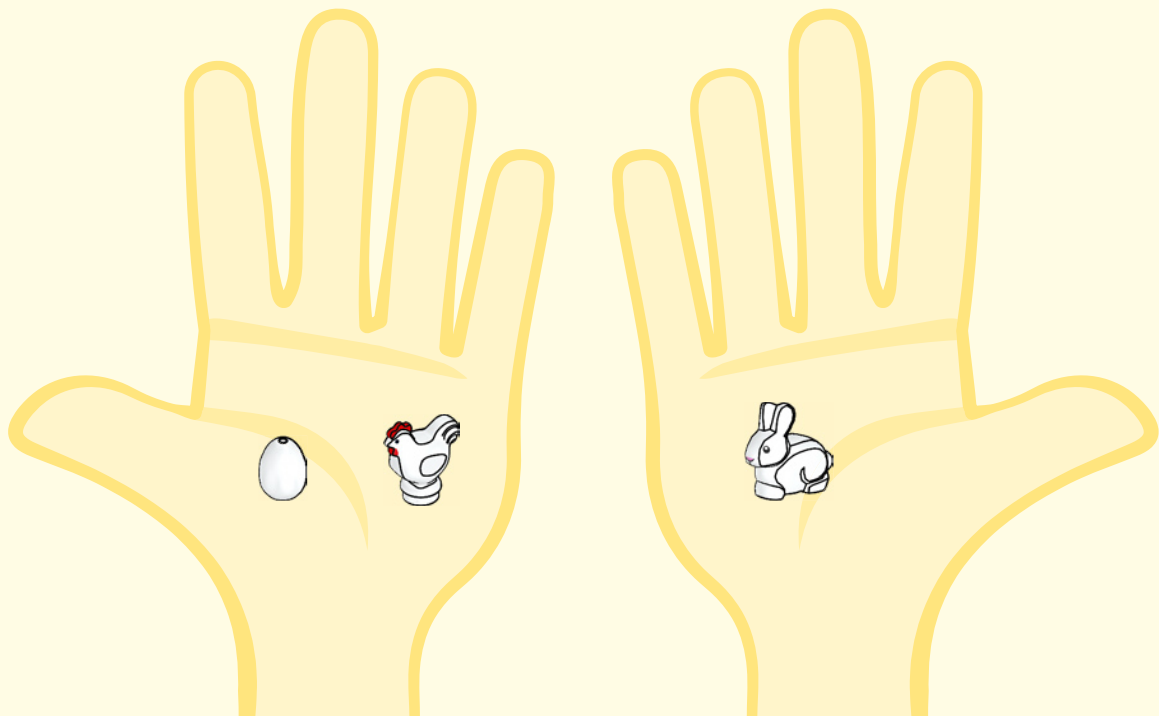

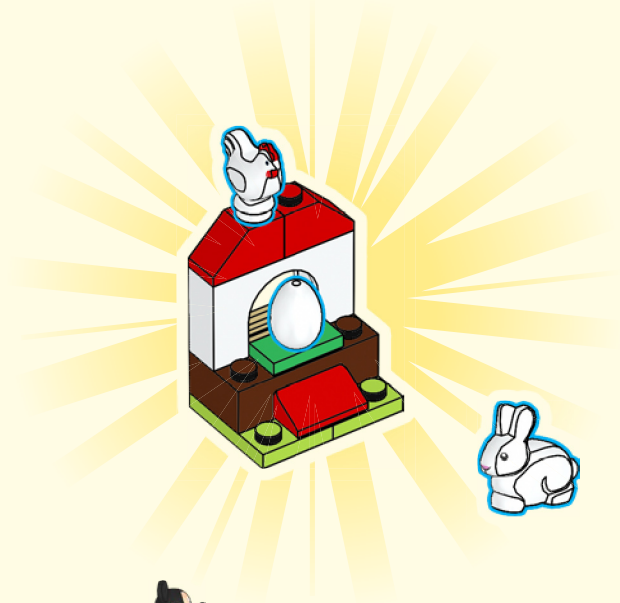

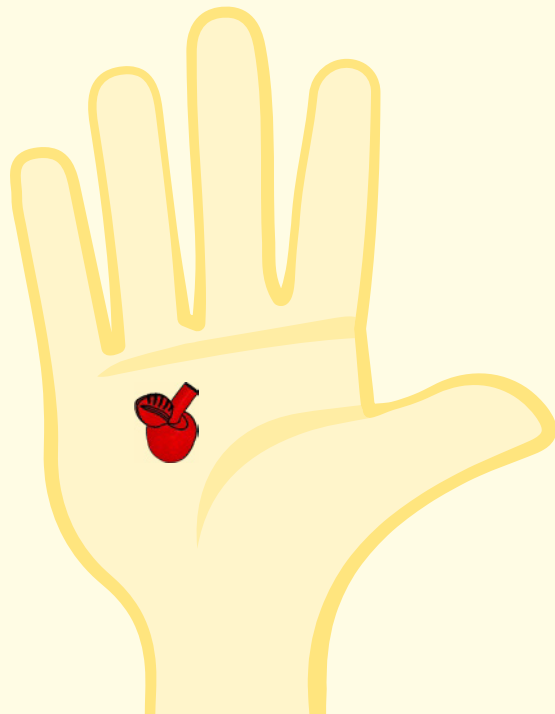
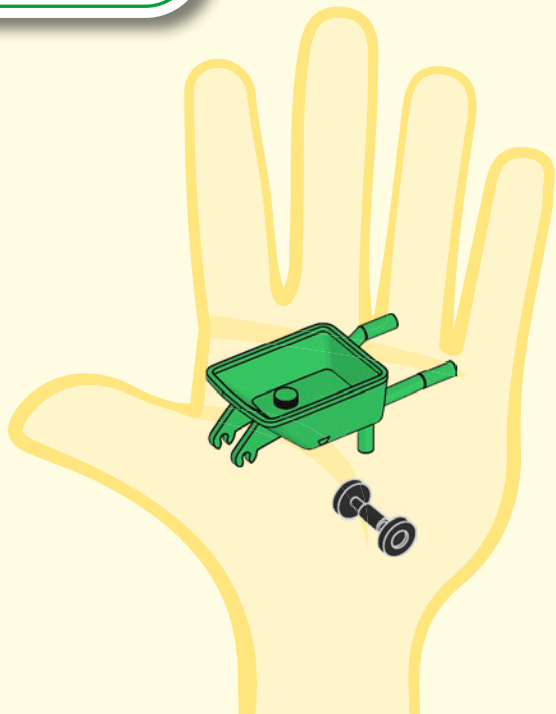

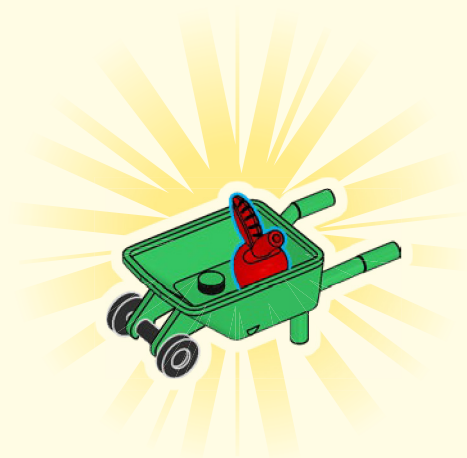
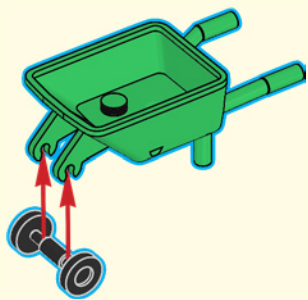

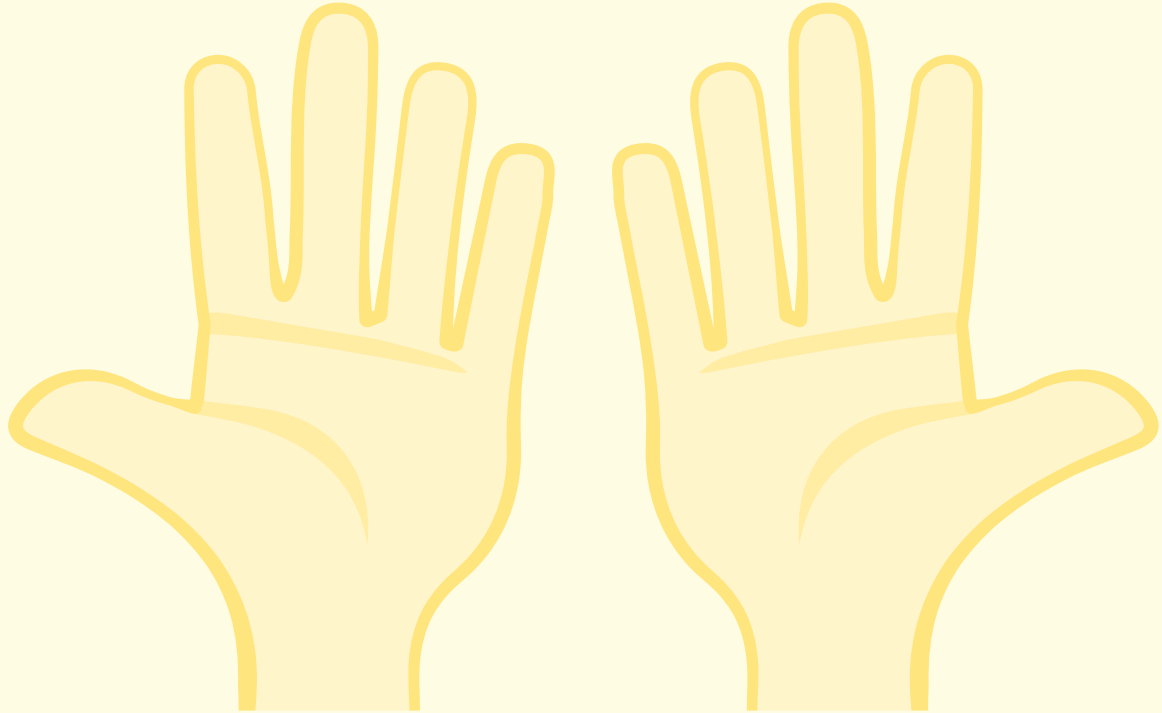

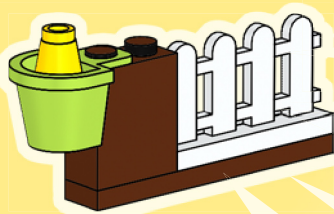
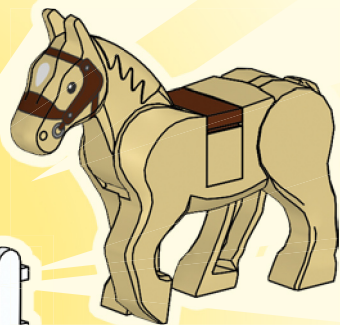
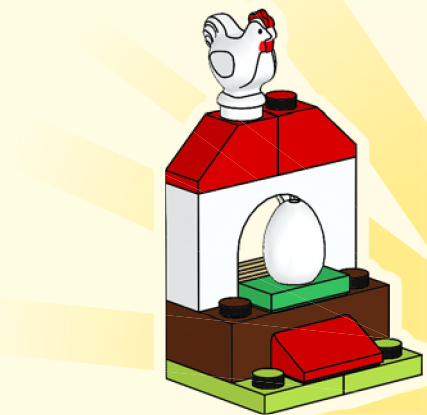

Disney
MICKEY
AND FRIENDS



 ©Disney
www.disney.com

LEGO and the LEGO logo are trademarks of the LEGO Group. ©2021 The LEGO Group. 6370279