

76092

LEGO and the LEGO logo are trademarks of the LEGO Group. ©2018 The LEGO Group.

DC All DC characters and elements © & ™ DC Comics.

WB SHIELD: TM & © WBEI. (s18)

6222196



WIN
GO TO WWW.LEGO.COM/PRODUCTFEEDBACK AND GIVE US YOUR SHORT **FEEDBACK** ABOUT THIS LEGO® SET FOR A CHANCE TO WIN A COOL LEGO PRIZE.

Terms & Conditions apply

LEGO.com/productfeedback

GEWINNE

Erzähle uns auf www.LEGO.com/productfeedback

etwas über die Erfahrungen, die du mit diesem LEGO® Set gemacht hast, und sichere dir die Chance auf einen coolen LEGO Preis!

Es gelten die Teilnahmebedingungen

GAGNE

Rends-toi sur www.LEGO.com/productfeedback

et donne-nous quelques commentaires sur ce produit LEGO® pour avoir une chance de gagner un prix LEGO !

Voir Conditions Générales

GANA

Visita www.LEGO.com/productfeedback

y envíanos tu opinión acerca de este set LEGO®. ¡Participarás en el sorteo de un premio LEGO!

Términos y Condiciones aplicables

获取奖品

登录 www.LEGO.com/productfeedback

给出关于此乐高®套装的简短反馈，就有机会获得炫酷乐高奖品

《条款及条件》适用

1x 614610	1x 6066342	2x 4516843	4x 302326	1x 6209744	1x 4143005	4x 6011380	1x 6211453	2x 4211090	2x 4539481	2x 6011375	1x 4654577
1x 6211460	1x 4278275	1x 6181713	1x 6209777	1x 6181720	3x 403223	1x 6116602	2x 4646864	2x 4540386	2x 4211506	2x 6028812	2x 6134236
1x 9552	1x 4220516	1x 6210463	1x 6210016	4x 4543857	1x 4543857	1x 403224	2x 4650500	1x 4210660	2x 4211094	1x 6176749	1x 6186610
1x 6001806	1x 6184782	1x 4121715	2x 4613153	1x 6103326	1x 4189123	1x 9553	1x 4528604	3x 6057458	1x 6176749	1x 6176749	1x 6076799
1x 6173922	1x 6092565	1x 4596914	1x 6179660	1x 302323	3x 6057458	1x 6076799	1x 4211079	6x 4508215	2x 4188534	1x 6179660	1x 6186610
1x 6186051	6x 4508215	2x 4188534	1x 6179660	1x 6186610	1x 6076799	1x 4211079					

Customer Service
Kundenservice
Service Consommateurs
Servicio Al Consumidor

LEGO.com/service or dial





DC
**SUPER
HEROES**



76096



76097



76098

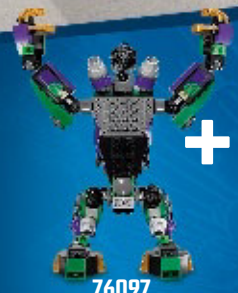

76097

+



76096

=



76096



76097



76098

**JUSTICE
LEAGUE**



JUSTICE LEAGUE and all related characters and elements © & ™ DC Comics.



WB SHIELD: TM & © WBEI. (s18)



DC
**SUPER
HEROES**



**MIGHTY
MICROS**



All DC characters and elements © & ™ DC Comics.



WB SHIELD: TM & © WBEI. (s18)



LEGO® Mighty Micros
LEGO.com/apps

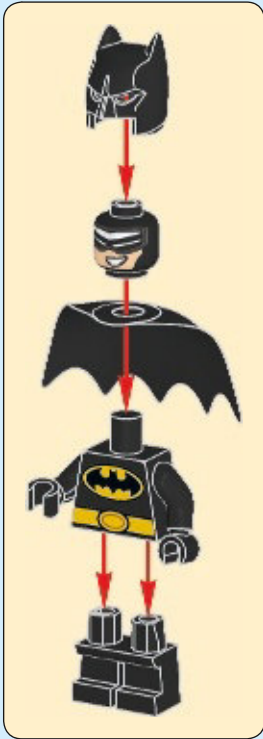

1

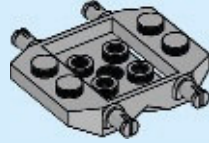

2

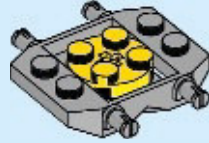

3

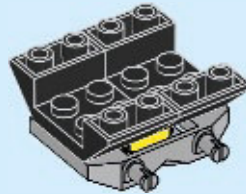

4

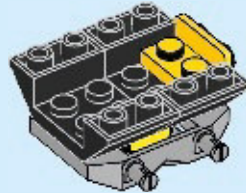

5

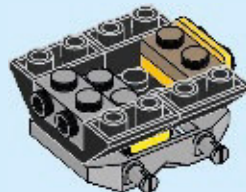

6

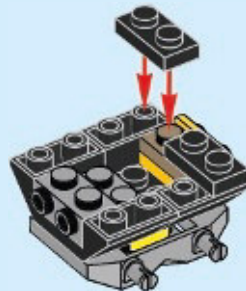

7

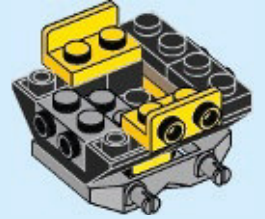

8

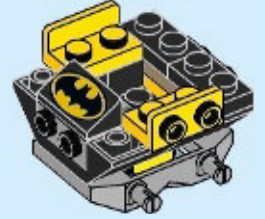

9

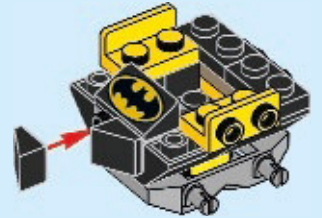

10



11

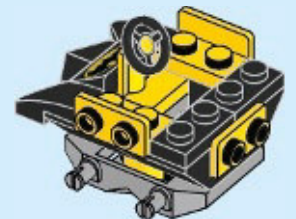

12

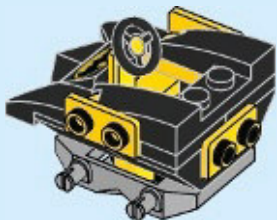

13

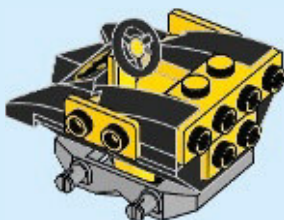

14

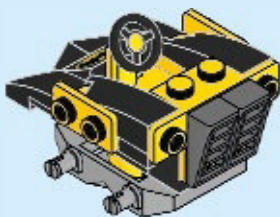

15

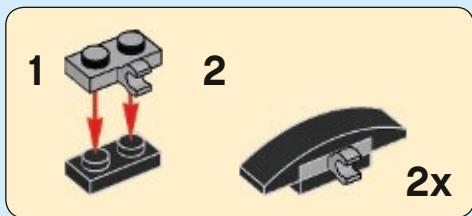
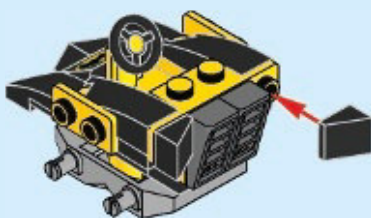

16

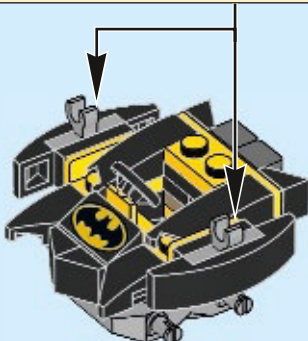

17

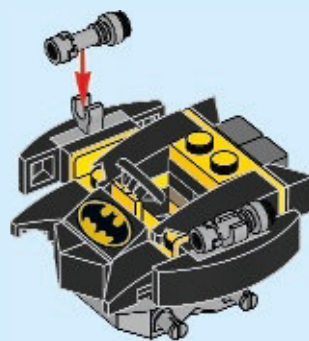

18

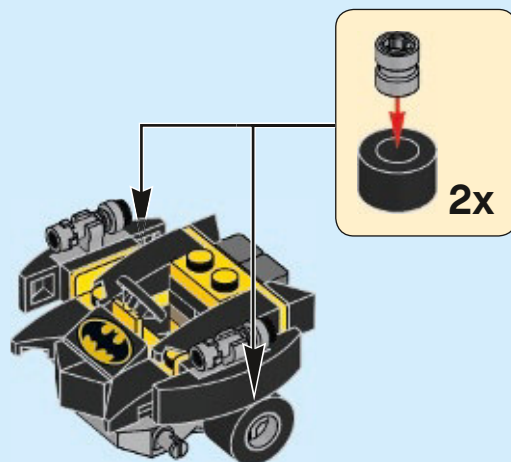

19

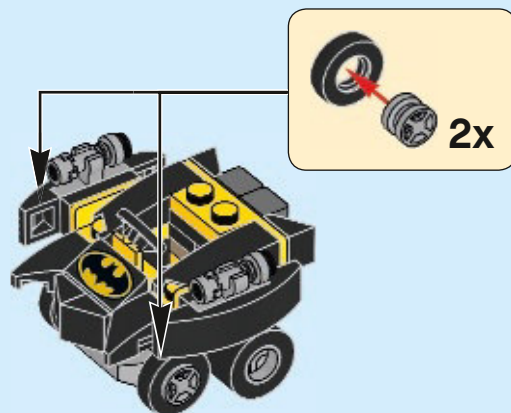

LEGO.com/service

LEGO and the LEGO logo are trademarks of the LEGO Group. ©2018 The LEGO Group. 6222187

DC All DC characters and elements © & ™ DC Comics.

WB SHIELD: TM & © WBEI. (s18)

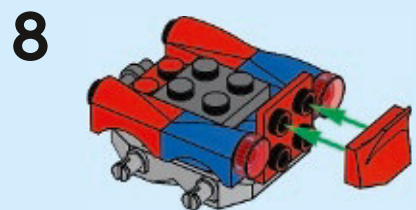
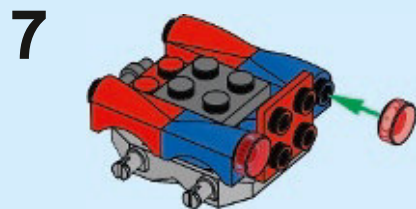
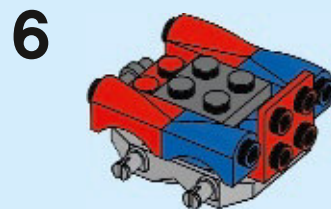
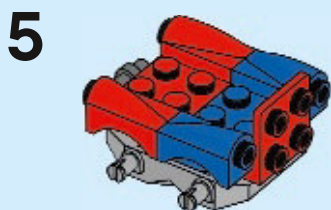
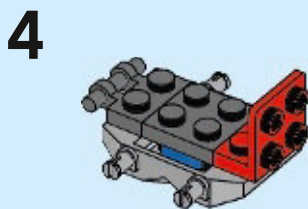
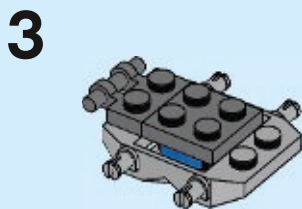
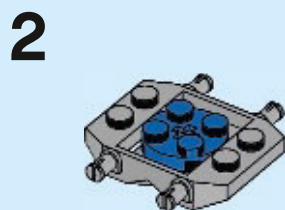
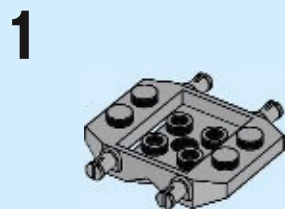
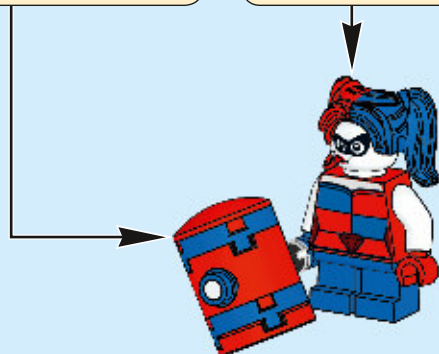
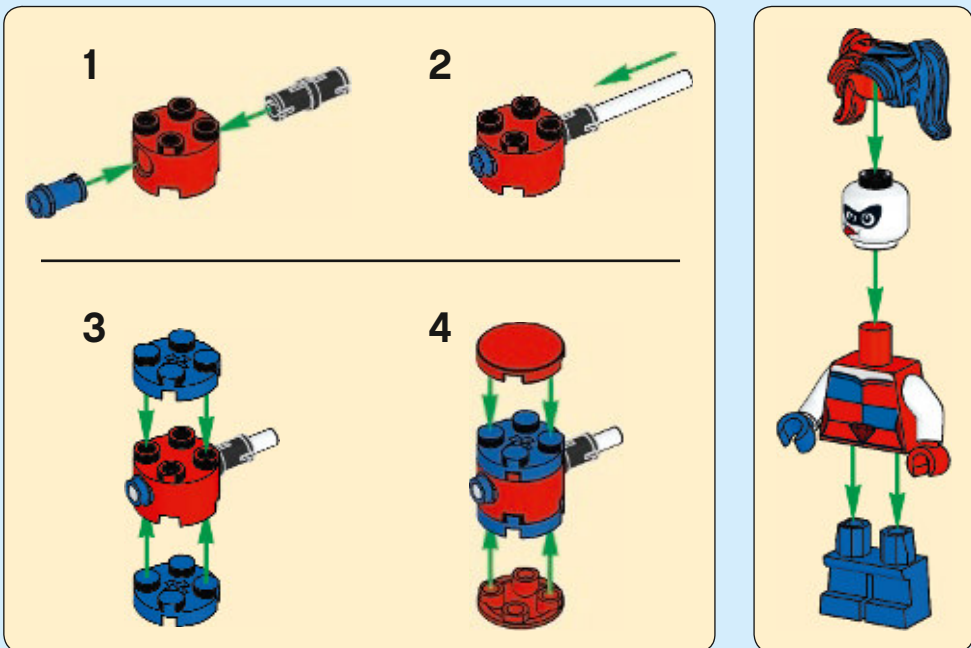

9

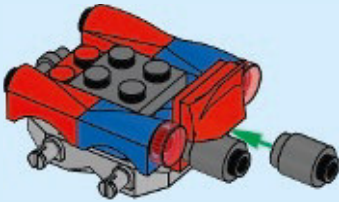

10

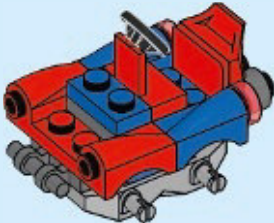

11

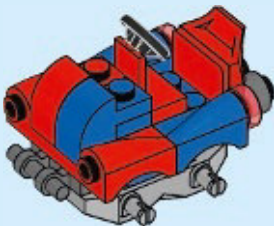

12

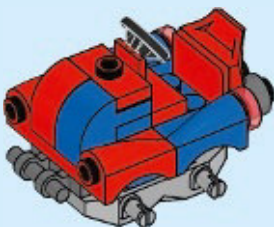

13

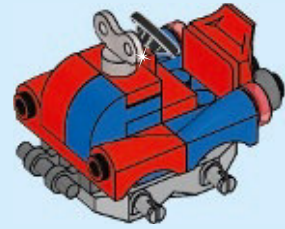

14

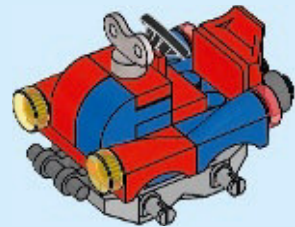

15

