



STAR WARS

75072



SERIES 2

MICROFIGHTERS

2

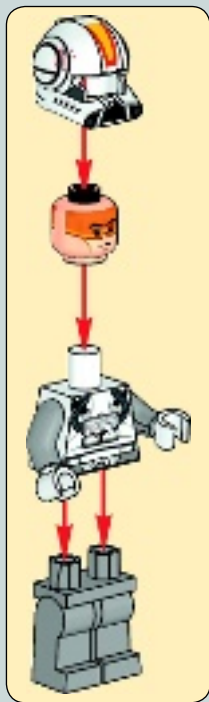

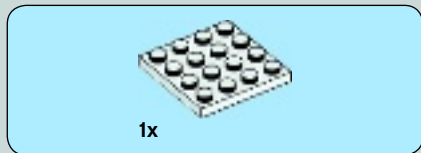
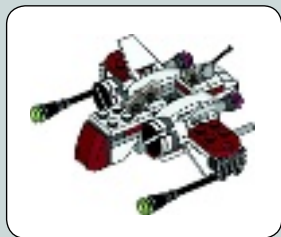

1

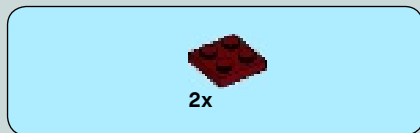

2

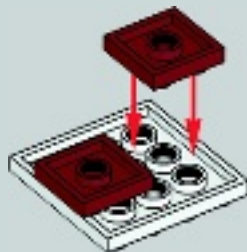

3



2x



2x

3

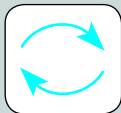

4



1x



2x

4



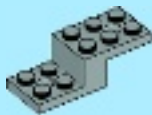

1x

5

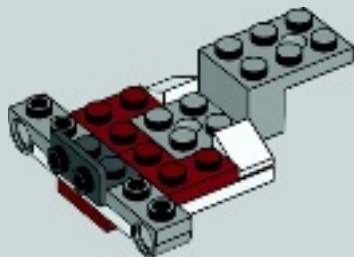



1x

6

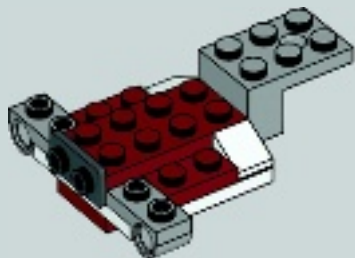

6



2x



2x

7

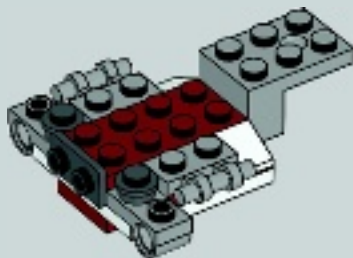



1x



2x

8

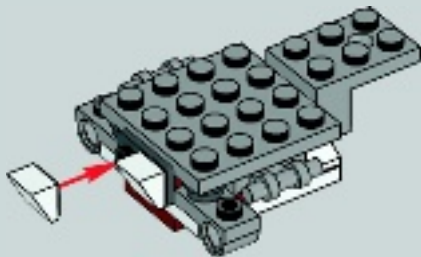

8



1x



2x



1x

9

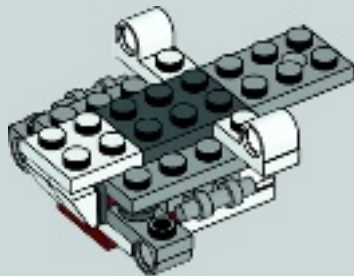



1x



1x



2x

10

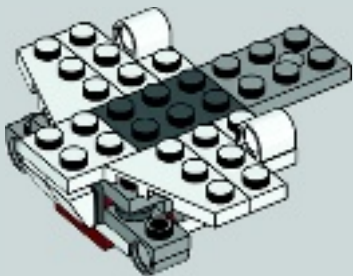

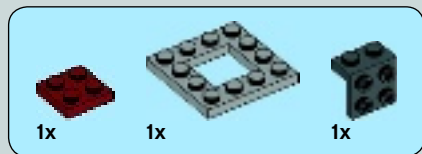

11

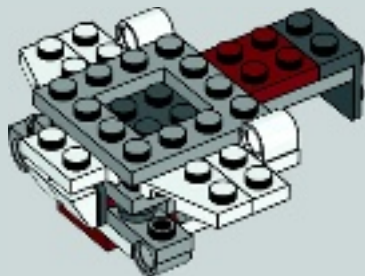



1x

12

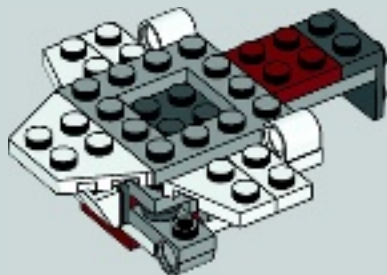



2x

13

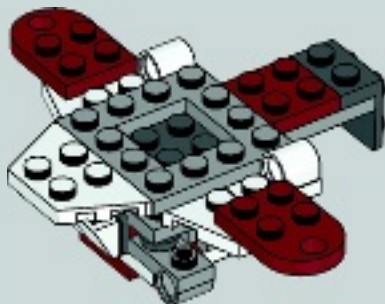

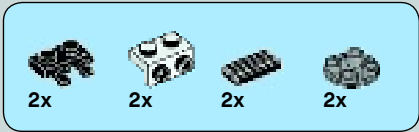

14

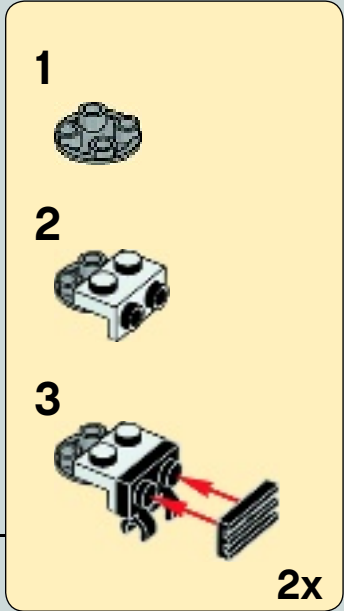
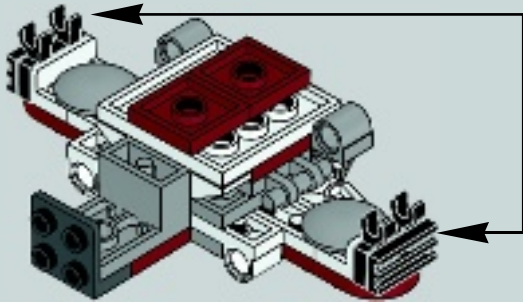



2x

15

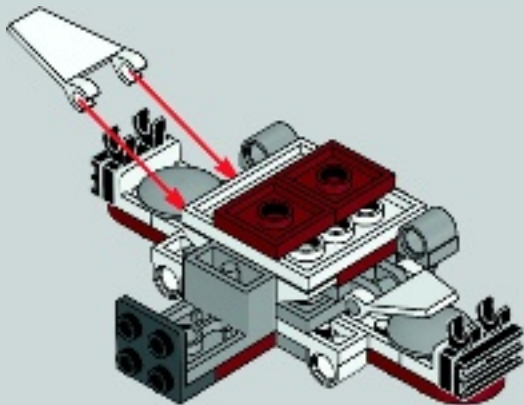



2x



2x

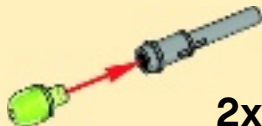

2x



16

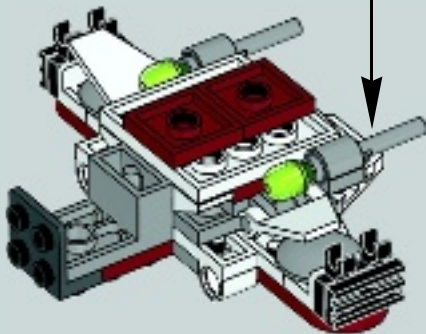



2x

17

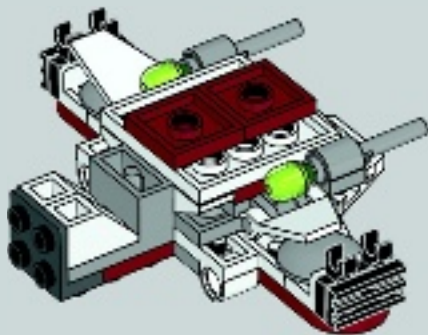



1x



1x

18

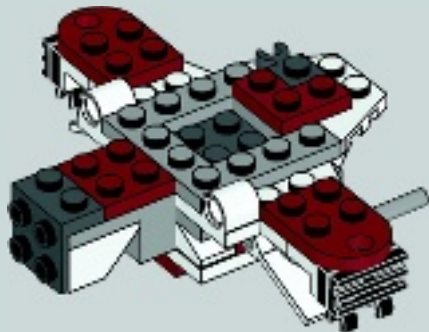
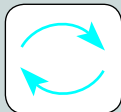



2x



2x

19

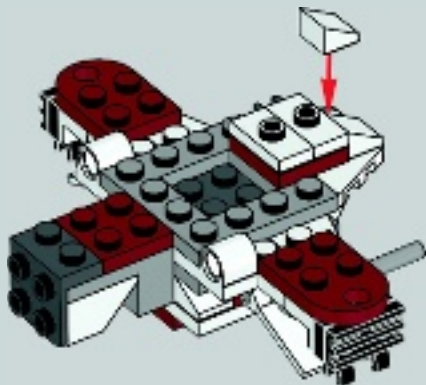



2x



1x

20

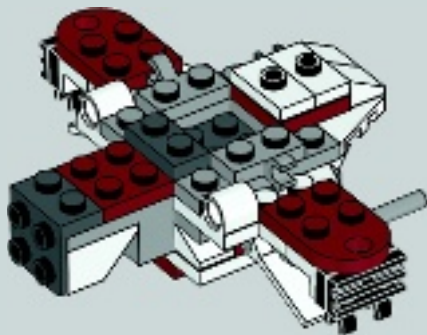



2x

21

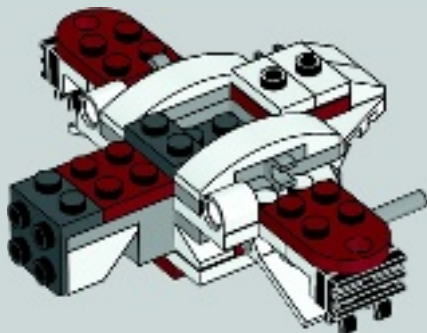



1x



2x

22

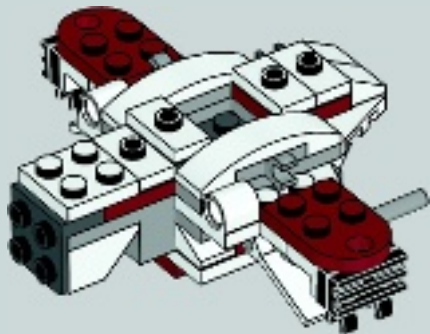



1x



3x

23





2x



1x

24

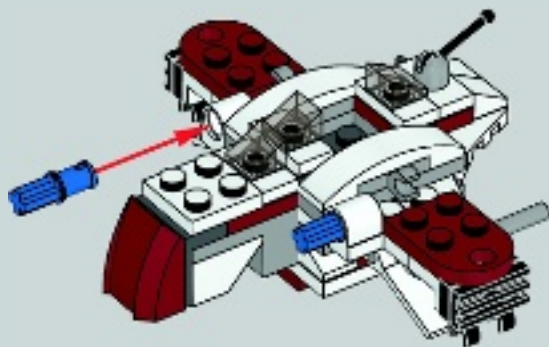



2x



2x



2x

25

1



2



2x

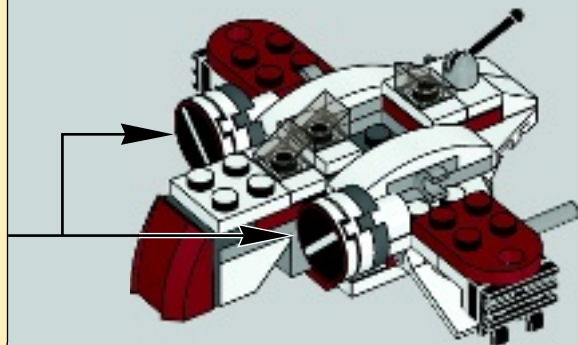



2x



2x



2x



2x

26

1

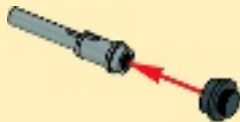

2

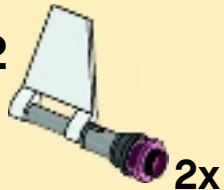

2x

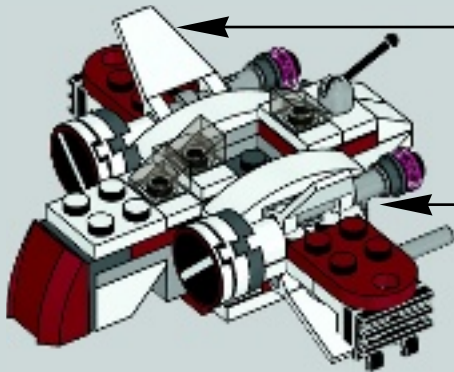



27

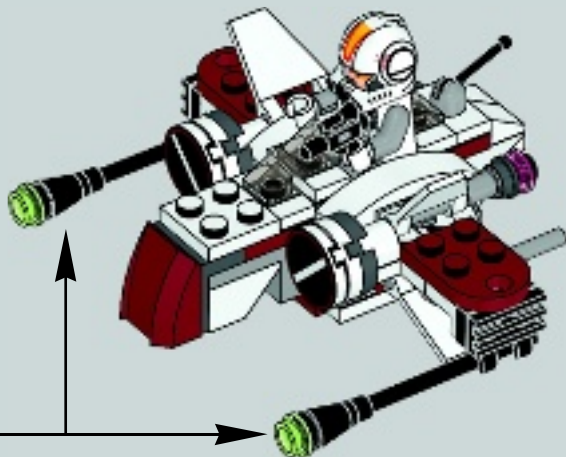
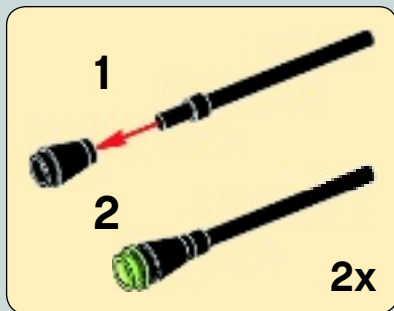

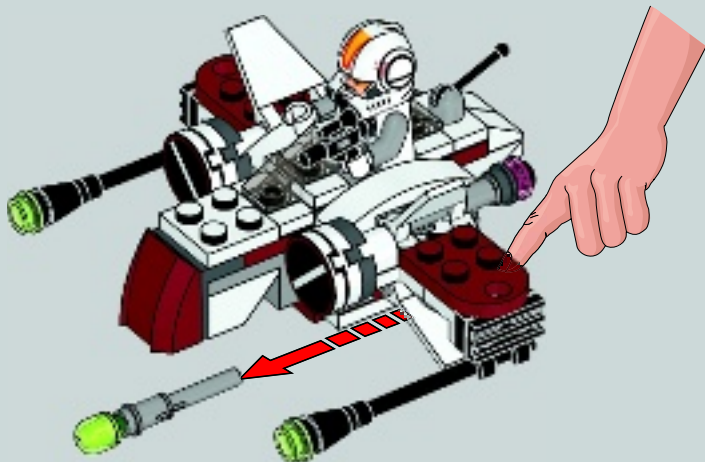

 6x 4504369	 1x 4243812	 4x 6023099	 1x 4609050	 1x 6028811	 1x 4221775	 1x 4587212	 2x 4211042
 2x 366501	 1x 4249506	 1x 6063556	 3x 4244368	 1x 4612621	 1x 4227657	 1x 4211063	 1x 6096721
 2x 6023806	 2x 6018774	 1x 6097106	 2x 4599535	 1x 4612621	 4x 4520320	 1x 6117972	 2x 6057034
 4x 6051511	 1x 4179875	 2x 4206482	 3x 4585751	 1x 4243797	 2x 6089147	 1x 6000606	 2x 4570481
 2x 302201	 1x 4179874	 2x 4529236	 3x 4585479	 2x 6028812	 1x 4211043	 4x 4210633	
 2x 362301	 2x 403201	 2x 241226	 1x 4539071	 2x 4211632			
 2x 6057414	 2x 6096585	 2x 6081988	 1x 6039200	 2x 4278273			



Customer Service
Kundenservice
Service Consommateurs
Servicio Al Consumidor
LEGO.com/service or dial



LEGO

**STAR
WARS**



MICROFIGHTERS

STAR WARS © & ™ 2015 Lucasfilm Ltd. © 2015 The LEGO Group. ™ & © WBEI.

Apple, the Apple logo, iPad, iPhone and iPod touch are trademarks of Apple Inc., registered in the U.S. and other countries. App Store is a service mark of Apple Inc.

Google Play is a trademark of Google Inc.



STAR WARS

Download the Microfighters App!



MICROFIGHTERS

