



# CLASSIC

7 [LEGO.com](https://www.lego.com)

10694









[LEGO.com/brickseparator](https://LEGO.com/brickseparator)

 Easy building  
Einfach zu bauen  
Construction facile  
Construcció fàcil  
Construção fácil  
Kezdő építőknek  
简单拼砌

 Medium building  
Mittelschwer  
 Construction intermédiaire  
Construcció intermedia  
Construção intermédia  
Gyakorló építőknek  
中级拼砌

 Advanced building  
Fortgeschritten  
 Construction avancée  
Construcció avançada  
Construção avançada  
 Tapasztalt építőknek  
高级拼砌



[LEGO.com/classic](http://LEGO.com/classic)

Page/页码

 6



Page/页码

 36



Page/页码  
46



Page/页码  
11



Page/页码  
26

Page/页码  
16

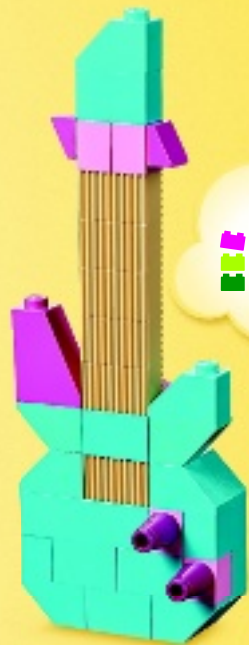



1x

1

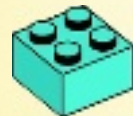



2x

2

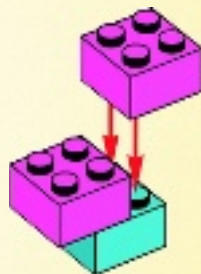

1x

3

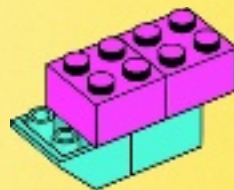



1x

4

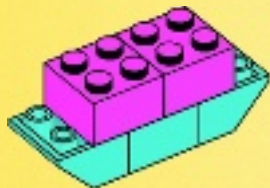

1x

5

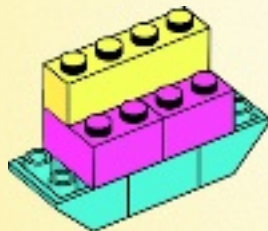



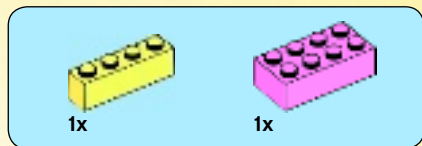

6

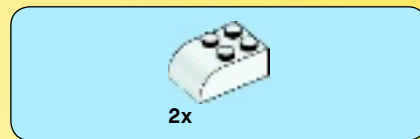
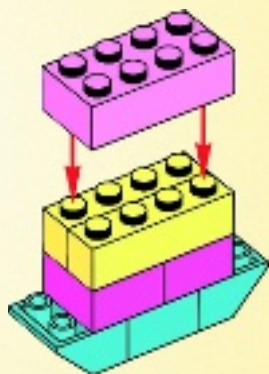

7





2x

8

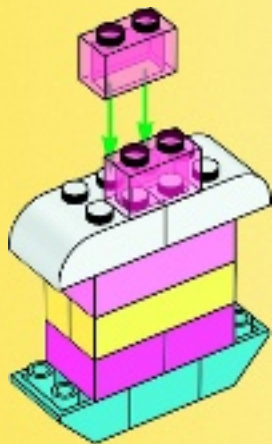

2x



1x

9



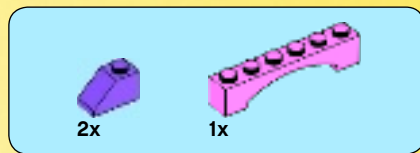

1

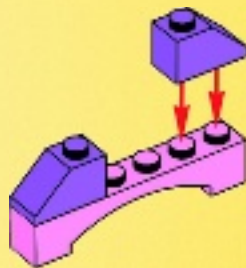



1x

2

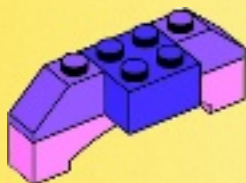

1x

3

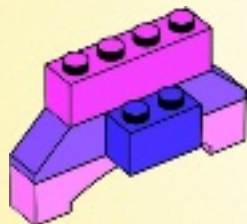



4

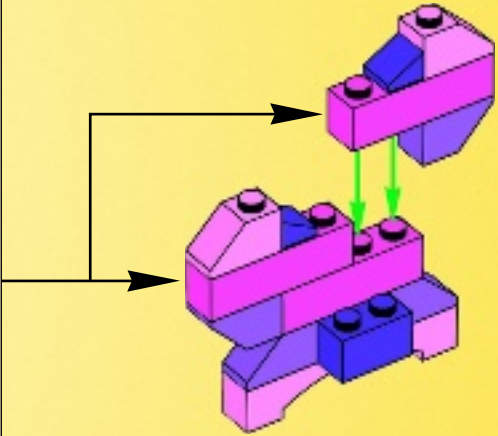
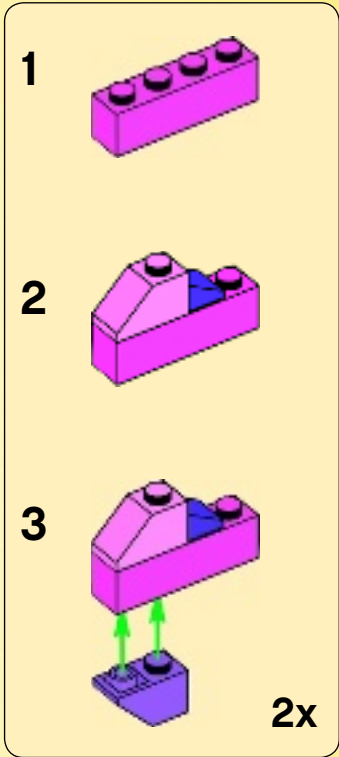



1x

5

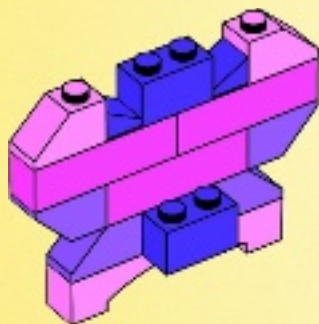



6

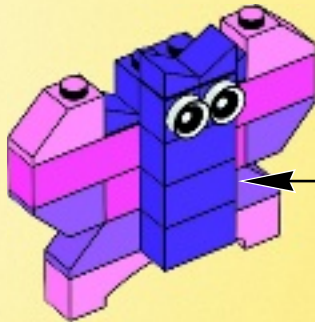
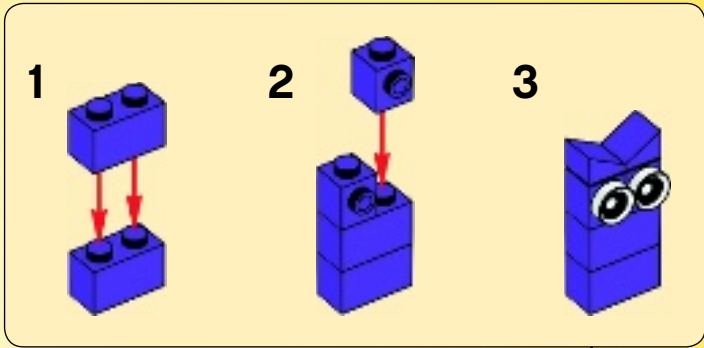



1x

1

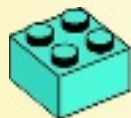





2x

2

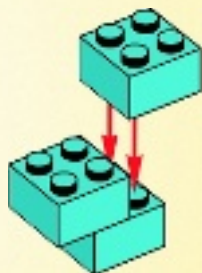

1x

3

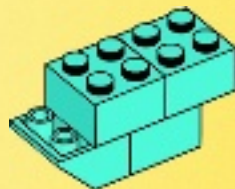



1x

4

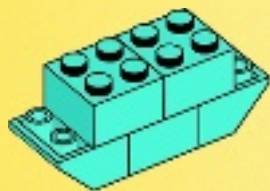

1x



1x



1x

5

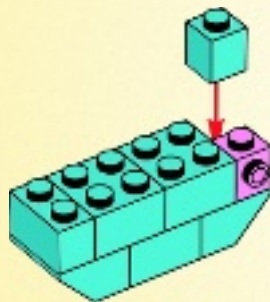



1x

6

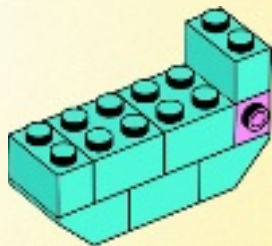

1x



1x

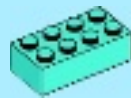

1x

7

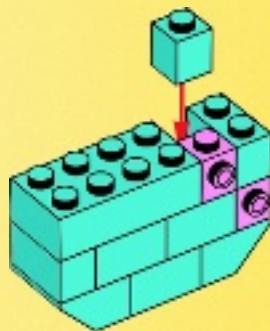



2x



1x

8

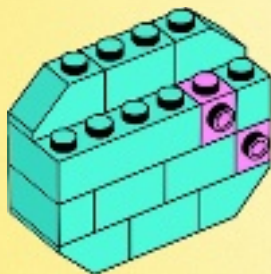

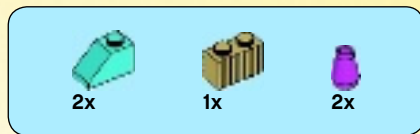

9

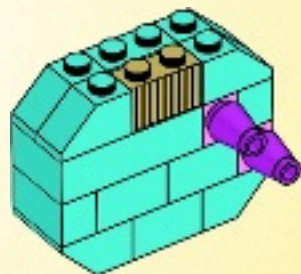

10

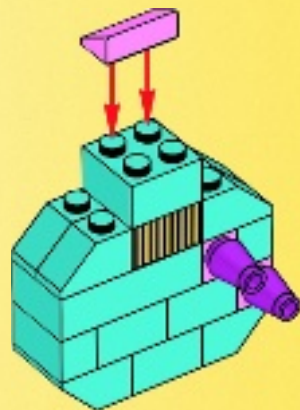



1x



1x

# 11

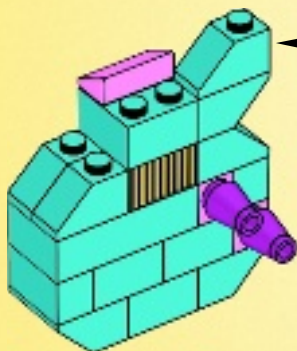
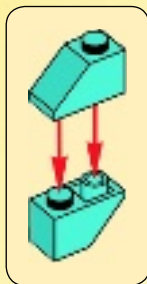

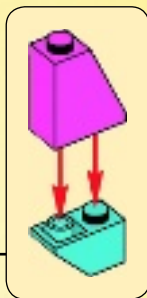

12

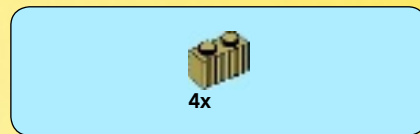
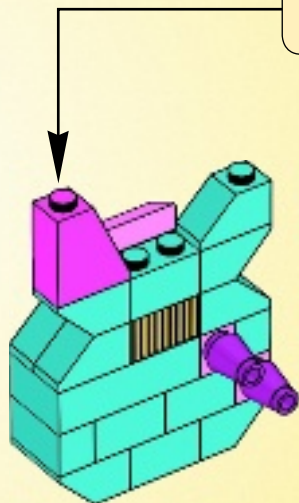

13

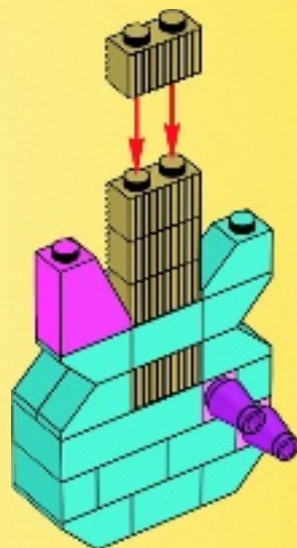



# 14

1



2

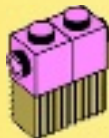

3

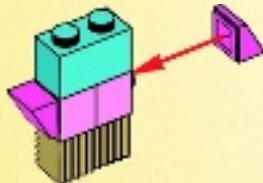

4

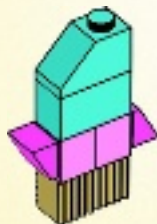



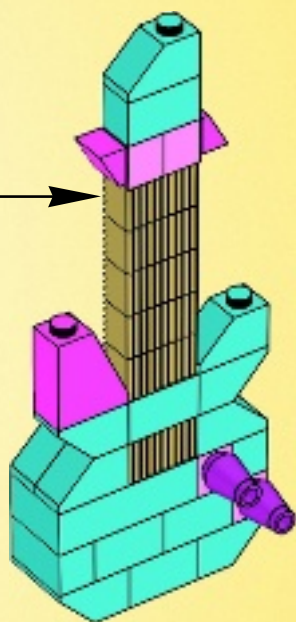



1x

1

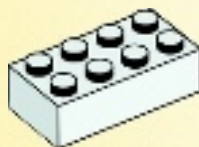



1x

2

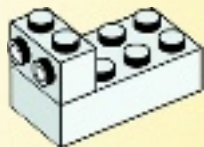

2x



1x

3

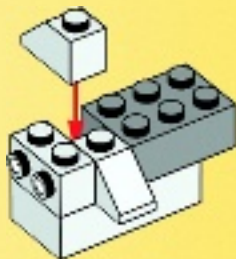



4

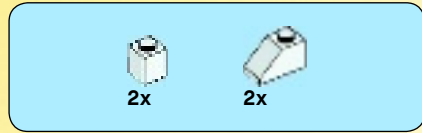
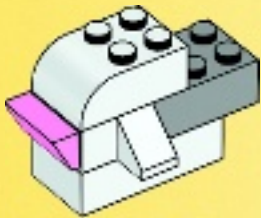

5

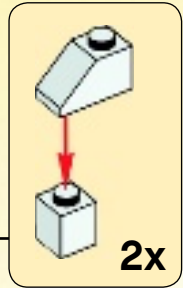
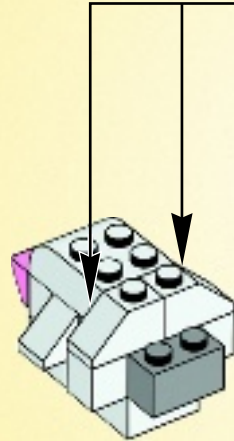
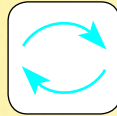



1x

6

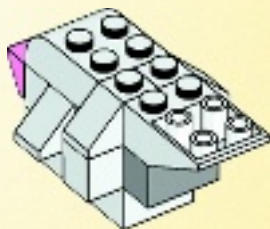

1x

7

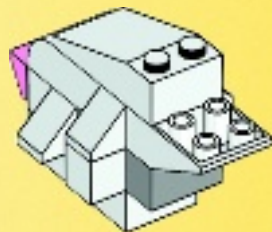



2x



1x

8

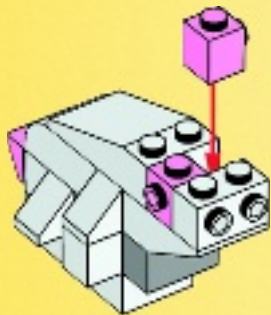

1x



2x

9

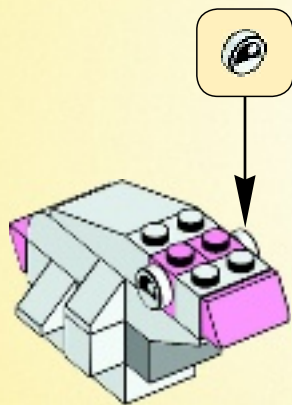



# 10

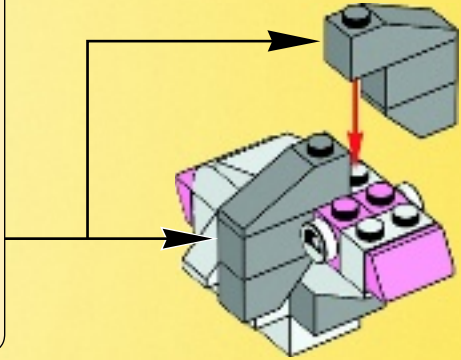
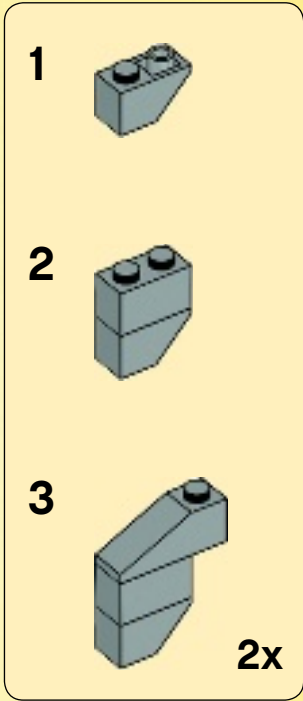



1x

11

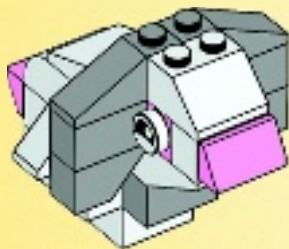





2x

# 12

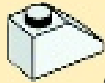
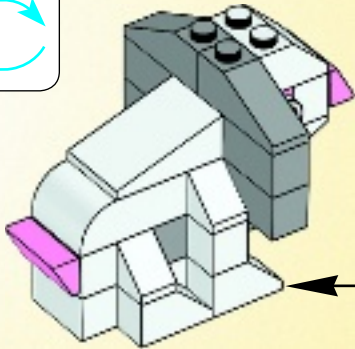

2x



2x

# 13

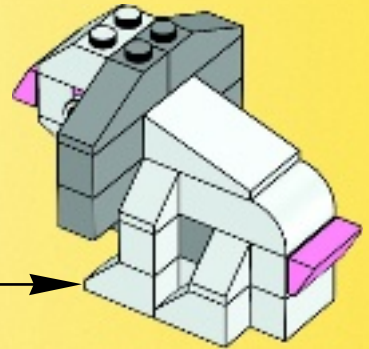
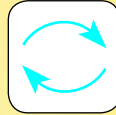

2x



2x

1

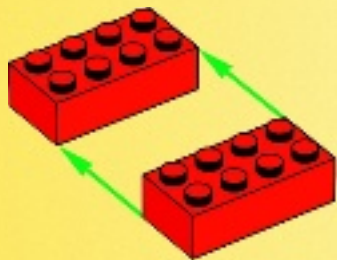

1x

2

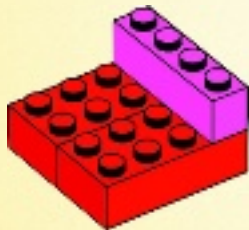

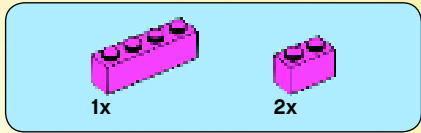

3

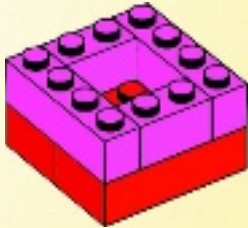

4

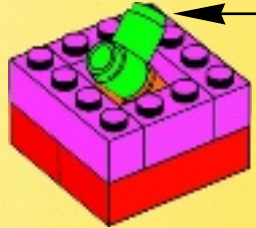
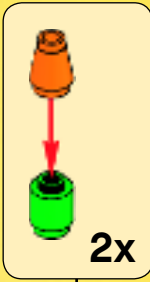



2x

1

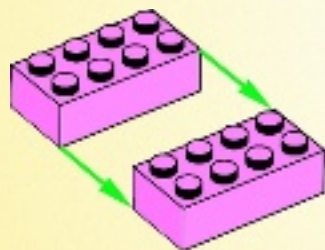



1x

2

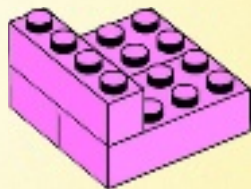

1x



1x

3

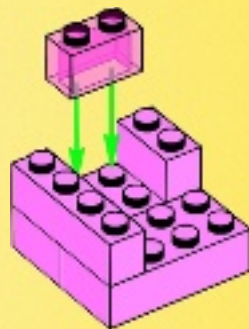



1x

4

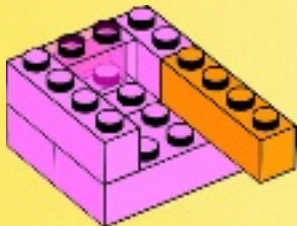

2x



1x

5

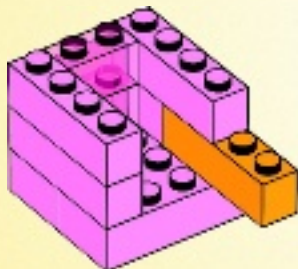



1x



2x

# 6

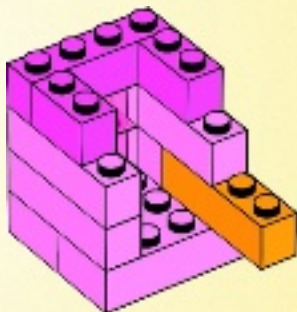

1x

# 7

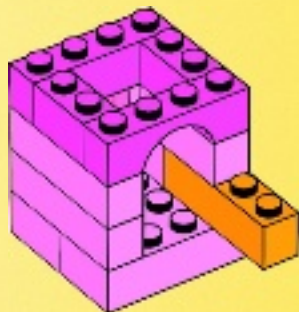



8

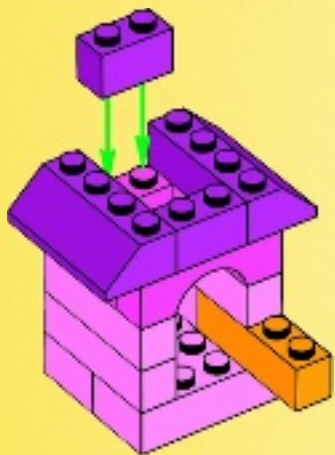

9

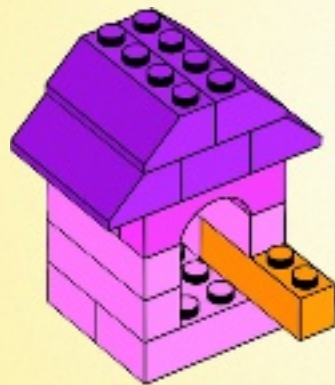





# 10

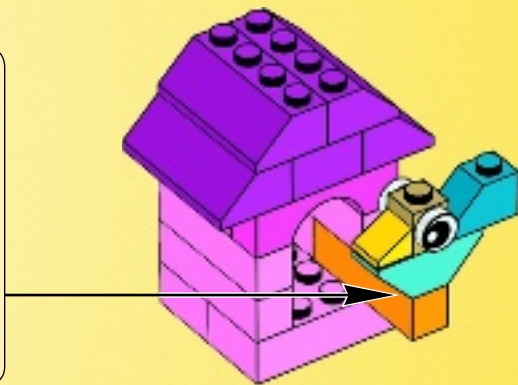



2x



2x

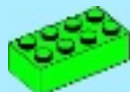

2x

# 11

## 1

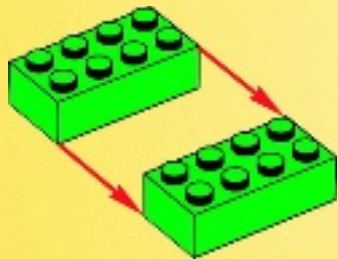

## 2

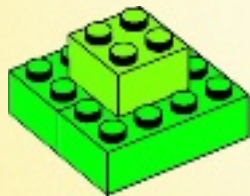

3

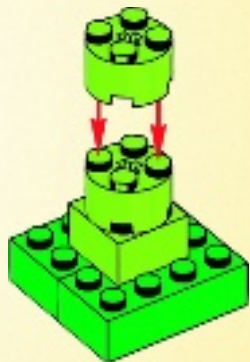

4



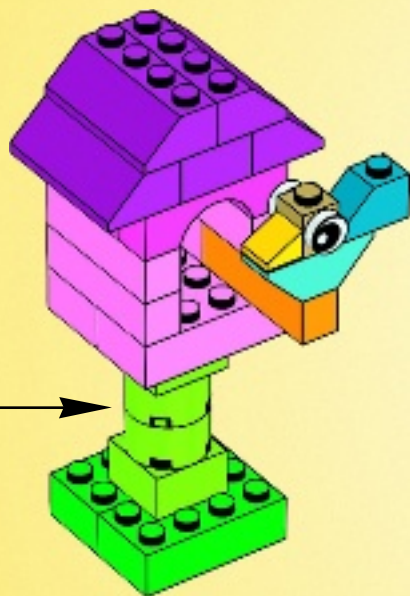



# 12

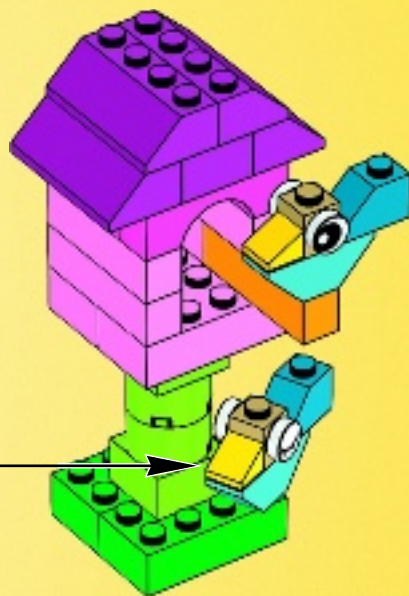

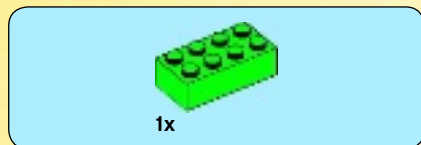

1

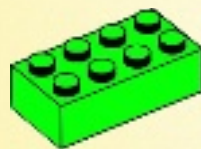



1x

2

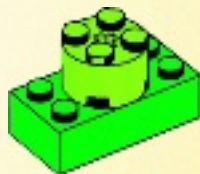

1x



1x

3

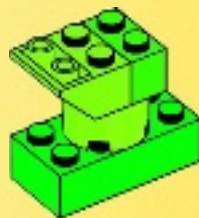



1x

4



1x



1x

5

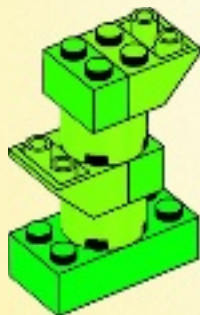





2x

6



2x

7





2x

8





1x

9

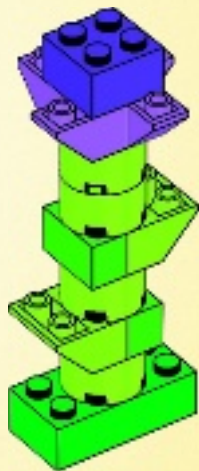

4x

10

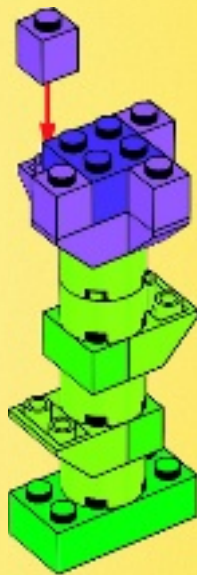



4x



1x

11

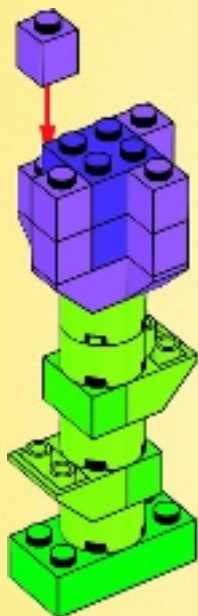



2x

12

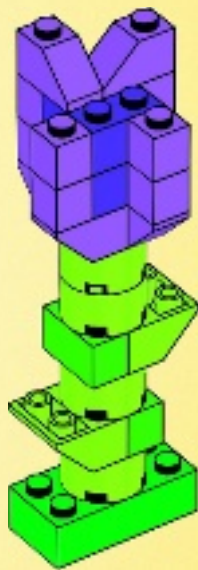



2x

13

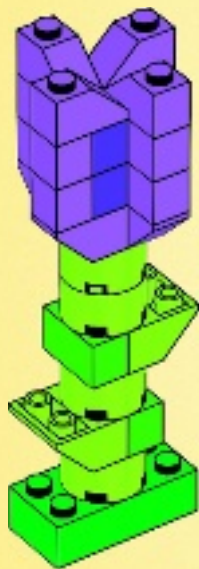



**More ideas online:**  
[LEGO.com/classic](http://LEGO.com/classic)

More ideas online:  
Weitere Ideen online:  
Plus d'idées en ligne :  
Más ideas en Internet:  
Mais ideias online:  
Online még több ötletet találsz:  
更多在线构思:  
[LEGO.com/classic](http://LEGO.com/classic)



**LEGO CLASSIC**



10692



10693

10694



10696

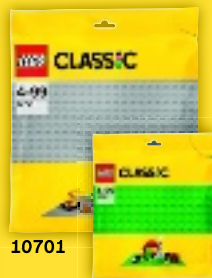

10701

10700







# Friends

41095



41091



41090





4x  
300501



2x  
300101



2x  
6058177



4x  
306201



8x  
4121932



2x  
303901



2x  
4500469



2x  
4143000



3x  
621501



4x  
6029156



2x  
6097402



2x  
6099548



4x  
300421



4x  
300321



2x  
300221



2x  
300121



4x  
4647553



6x  
4655900



2x  
4213568



4x  
300324



4x  
306224



3x  
4504381



3x  
4106356



4x  
306228



4x  
4153825



2x  
4153826



4x  
4518029



1x  
4654448



6x  
6096995



4x  
4519195



2x  
6003007



4x  
4518889



4x  
4220632



2x  
4165967



6x  
4527943



2x  
4529679



2x  
4211386



2x  
4211437



2x  
4211488



4x  
4211388



2x  
4244613



8x  
4621545



6x  
4517992



6x  
4621542



3x  
6057894



2x  
6062343



8x  
6004943



2x  
6036851



2x  
6058395



4x  
4517993



6x  
4550359



3x  
4518890



12x  
4520632



6x  
4621554



3x  
4649749



4x  
4517995



6x  
6022083



2x  
6036232



4x  
6104154



4x  
4653960



2x  
6063897



4x  
4567509



4x  
4642409



6x  
6003004



2x  
6100027



4x  
4619652



4x  
6092674



5x  
4653970



4x  
4625629



2x  
6070769



8x  
4619655



2x  
6100126



6x  
6070756



1x  
6022000



8x  
4651903



4x  
4655173



8x  
4619509



6x  
6022005



**Customer Service**

**Kundenservice**

**Service Consommateurs**

**Servicio Al Consumidor**

**LEGO.com/service or dial**



**: 00800 5346 5555**

**: 1-800-422-5346**