



# CLASSIC



10696





**WARNING: CHOKING HAZARD.**  
Small parts. Not for children under 3 years.



**AVERTISSEMENT : RISQUE D'ÉTOUFFEMENT.**

Contient des petites pièces. Ne convient pas aux enfants de moins de 3 ans.



**ADVERTENCIA: PELIGRO DE ASFIXIA.**

No recomendado para niños menores de 3 años. Contiene piezas pequeñas.

Warning! Choking hazard. Small parts.  
Achtung! Erstickungsgefahr. Kleinteile.  
Attention ! Risque d'étouffement. Petites pièces.  
Avvertenza! Pericolo di soffocamento. Parti piccole.  
Waarschuwing! Verstikkingsgevaar. Kleine deeltjes.  
iAdvertencia! Riesgo de asfixia. Piezas pequeñas.  
Advarsel! Kvælningsfare. Små dele.  
Varoitus! Tukehtumisvaara. Pieniä osia.  
Varning! Kvävningrisk. Små delar.  
Atenção! Perigo de asfixia. Peças pequenas.  
Προειδοποίηση! Κίνδυνος πνιγμού. Μικρά κομμάτια.  
警告! 窒息の危険性。小さな部品。  
警告! 小心窒息。当心小物件。  
경고! 질식 위험. 작은 부품 포함.  
Внимание! Риск удушения. Мелкие детали.  
Ostrzeżenie! Zagrożenie zadławieniem. Małe elementy.  
Upozornění! Nebezpečí udušení. Malé součástky.  
Upozornenie! Nebezpečenstvo udusenja. Malé súčasti.  
Figyelmeztetés! Fulladásveszély! Kis elemek.  
Обережно! Ризик задухи. Дрібні деталі.  
Urožorenje! Opasnost od gušenja. Sitni dijelovi.  
Упозорење! Опасност од гушења. Мали делови.  
Opozorilo! Nevarnost zadušitve. Majhni delčki.  
Avertisment! Pericol de sufocare. Piese mici.  
Внимание! Опасност от задавяне. Малки части.  
Brīdinājums! Aizīšanās risks. Sīkas daļas.  
Hoiatus! Lõmbumisohut. Väikesed osad.  
İspējimas! Uždusimo pavojus! Mažos detalės.  
Dikkat! Boğulma tehlikesi. Küçük parçalar.



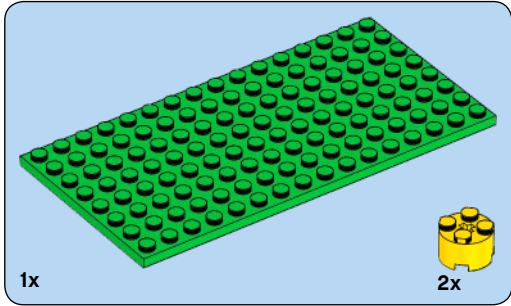
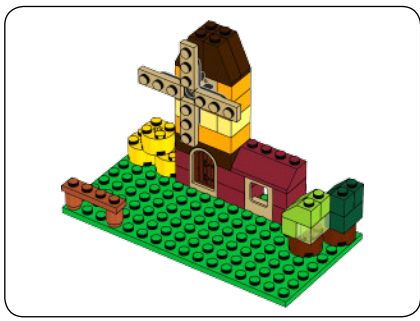

1

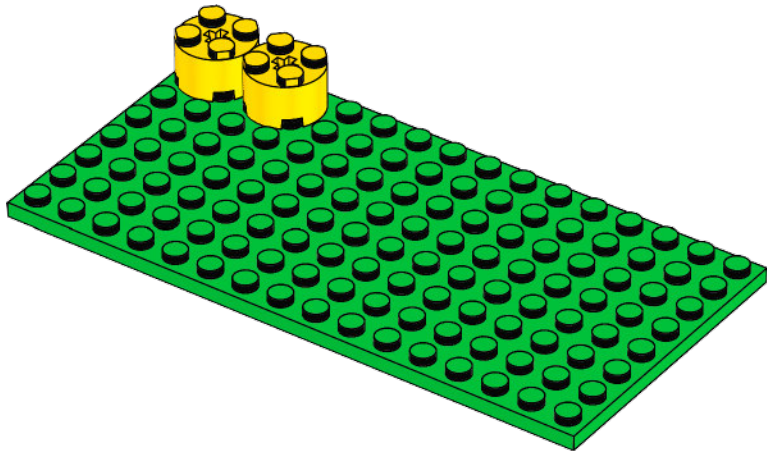

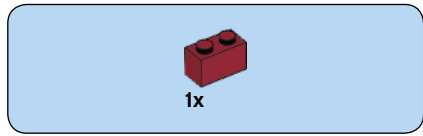

2

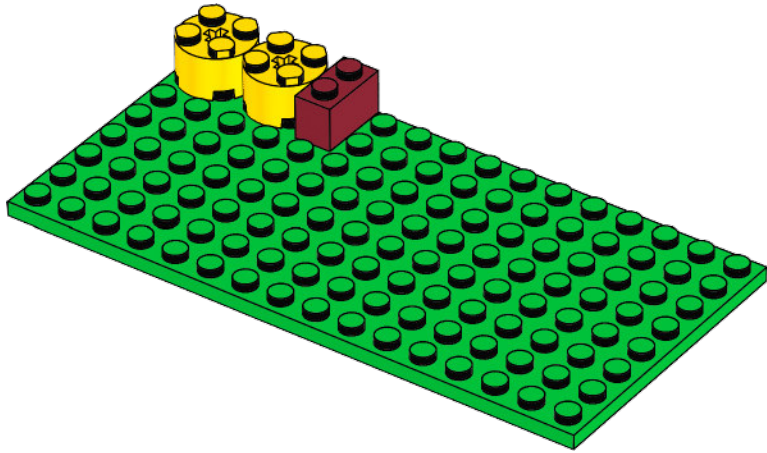

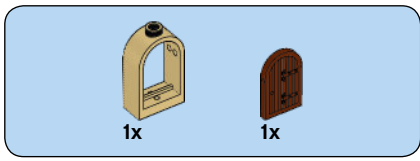

3

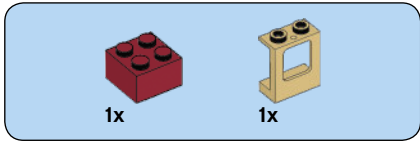
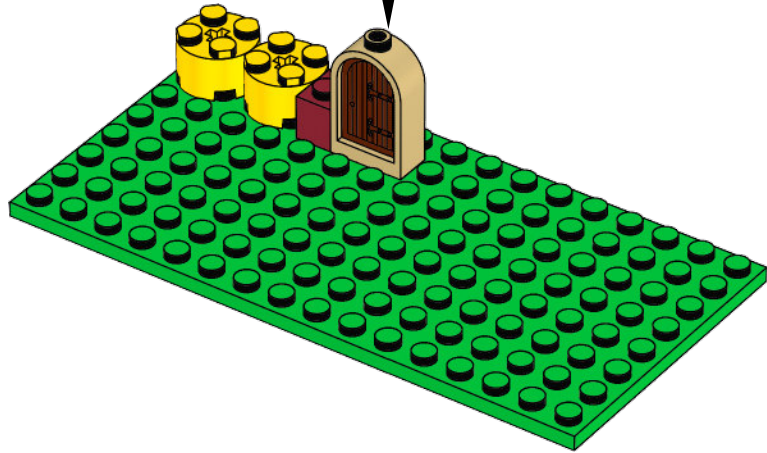
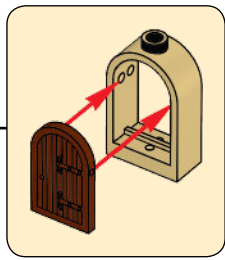

4

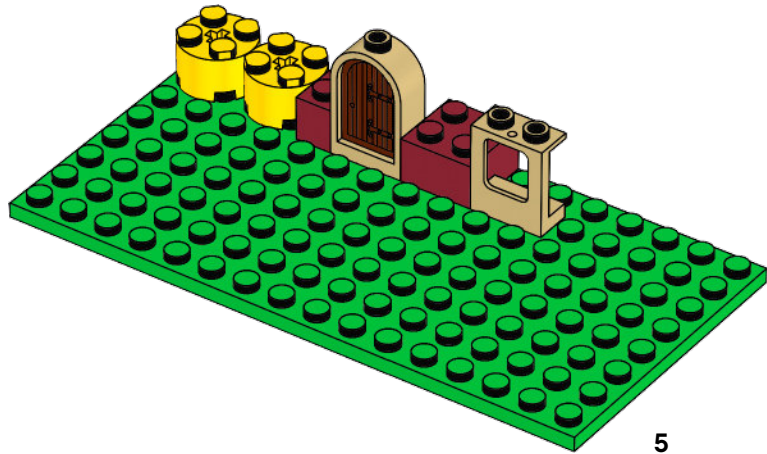



1x

5

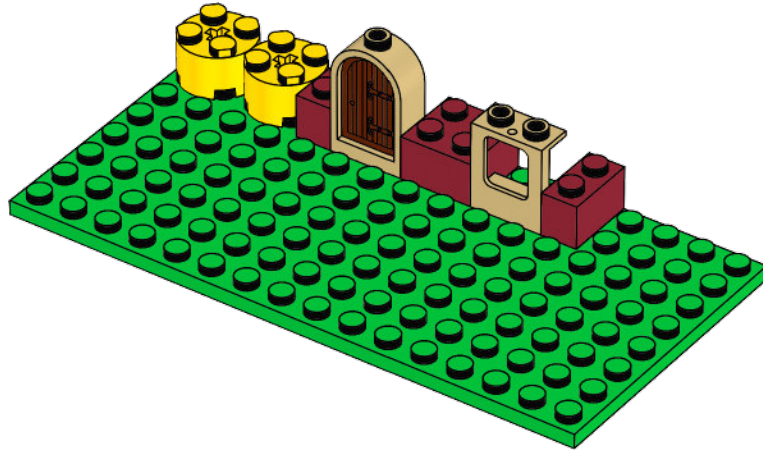

1x



1x

6

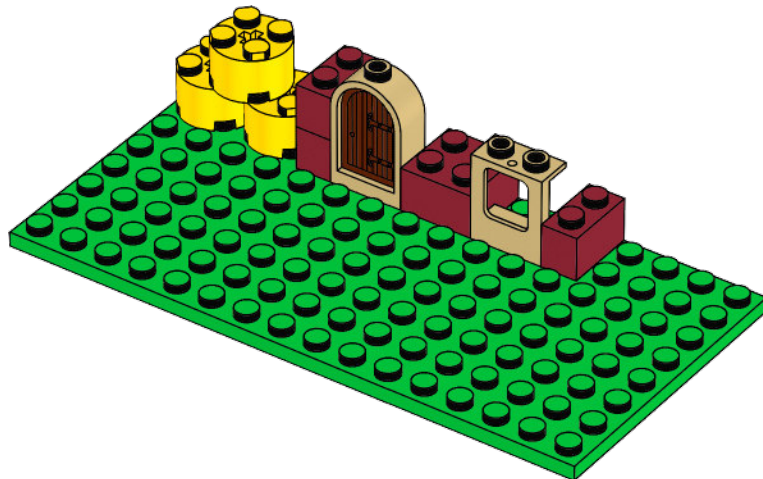

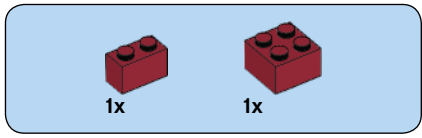

7

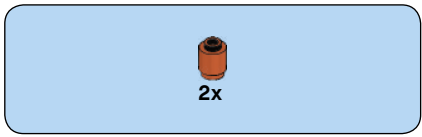
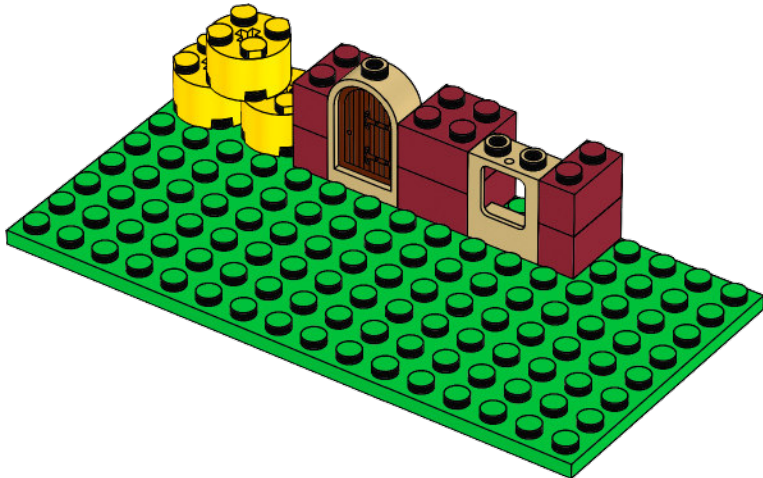

8

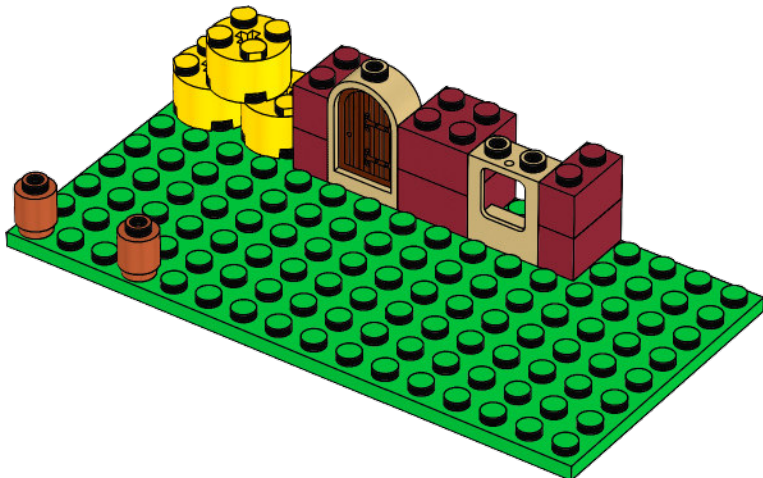

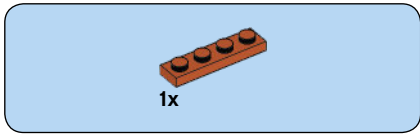

9

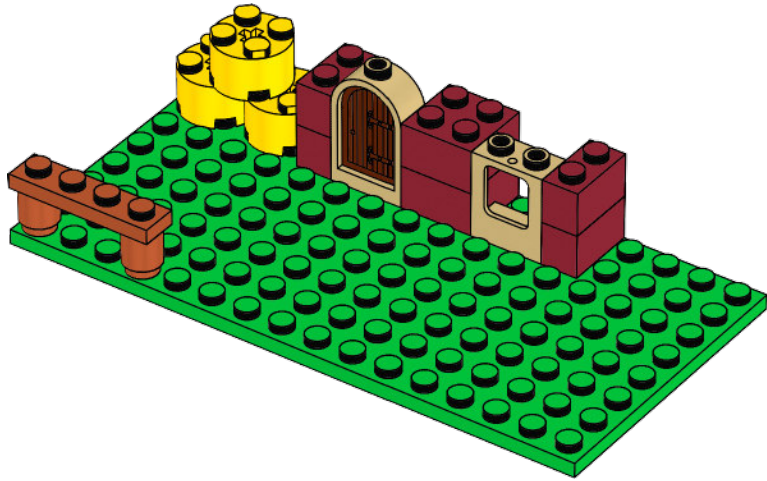



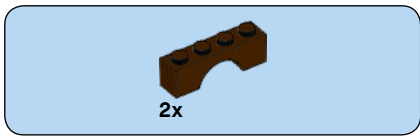

10

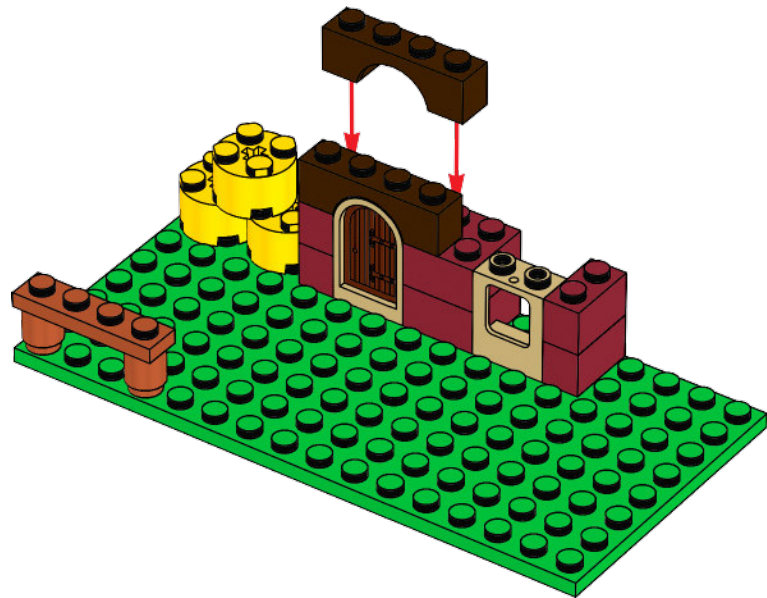

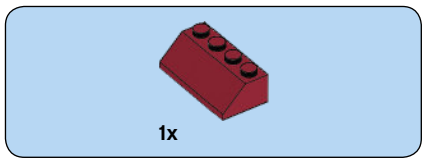

11

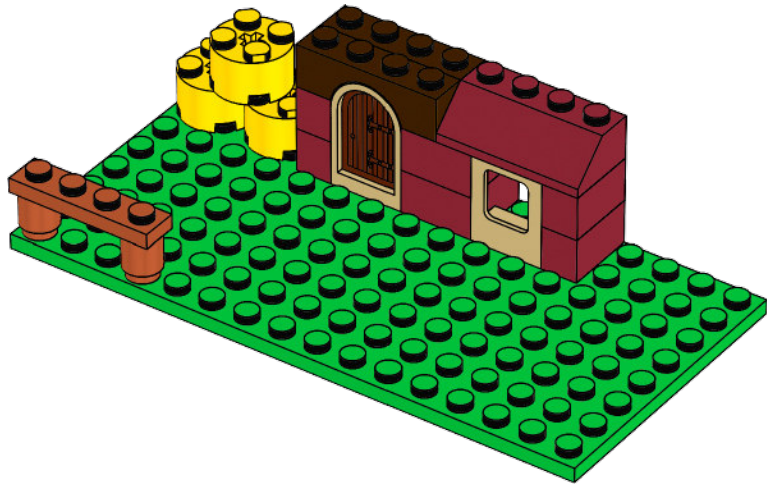

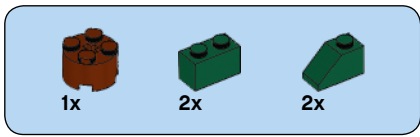

# 12

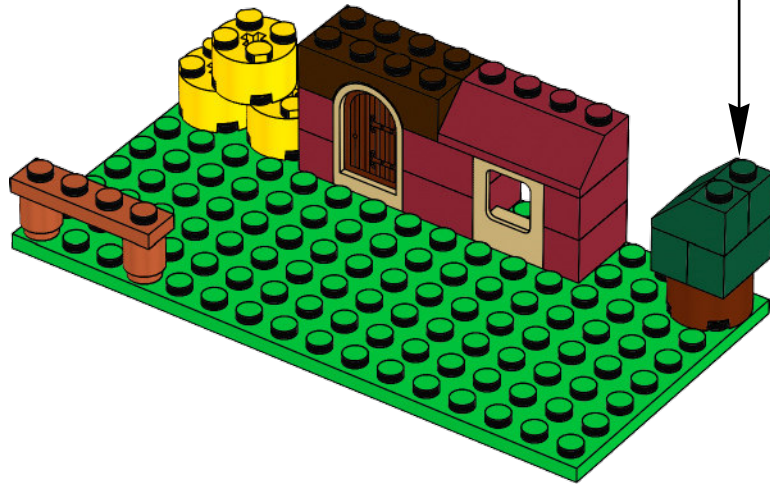
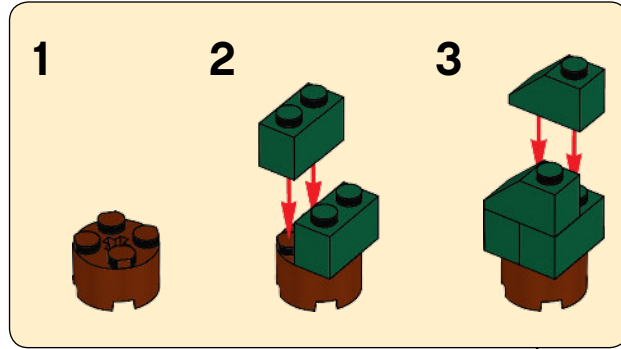

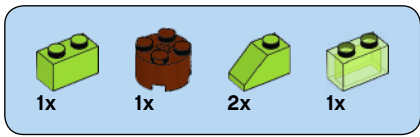

# 13

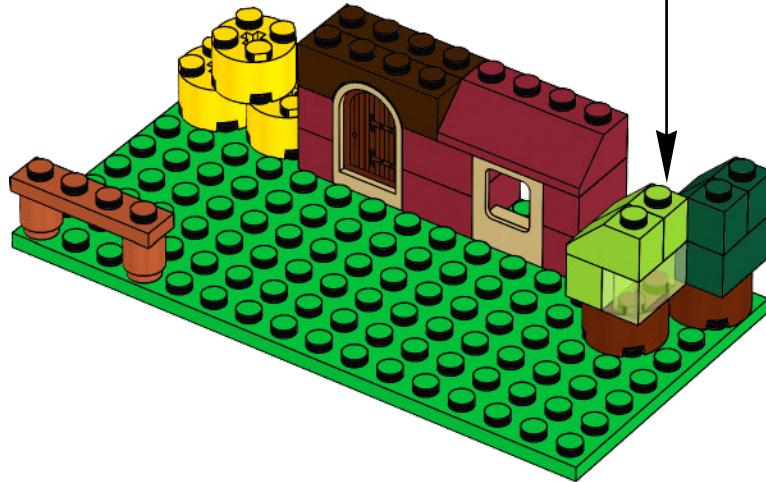
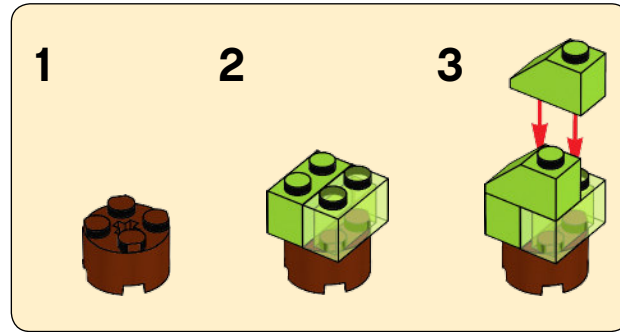

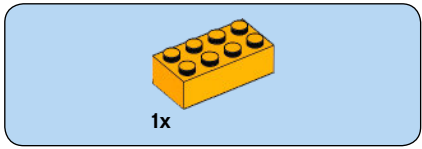

14

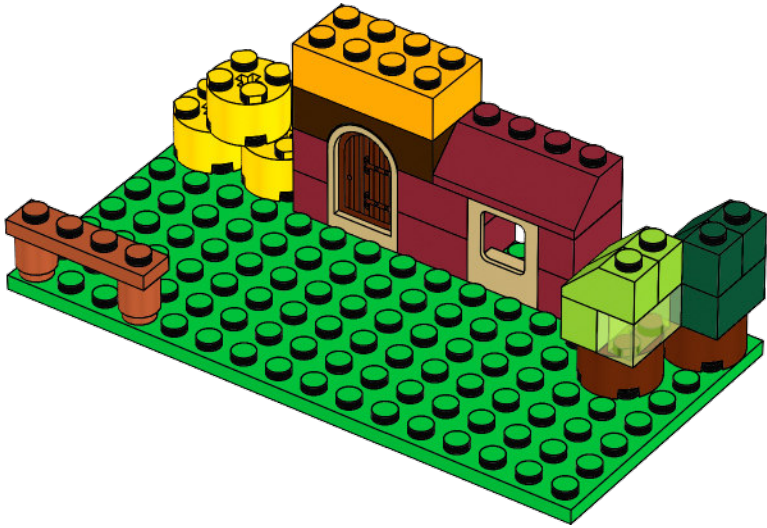

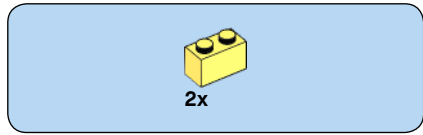

15



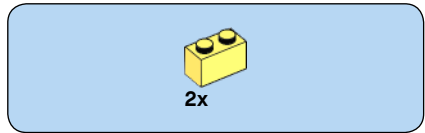

16



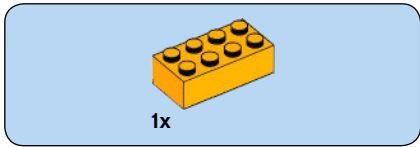

17

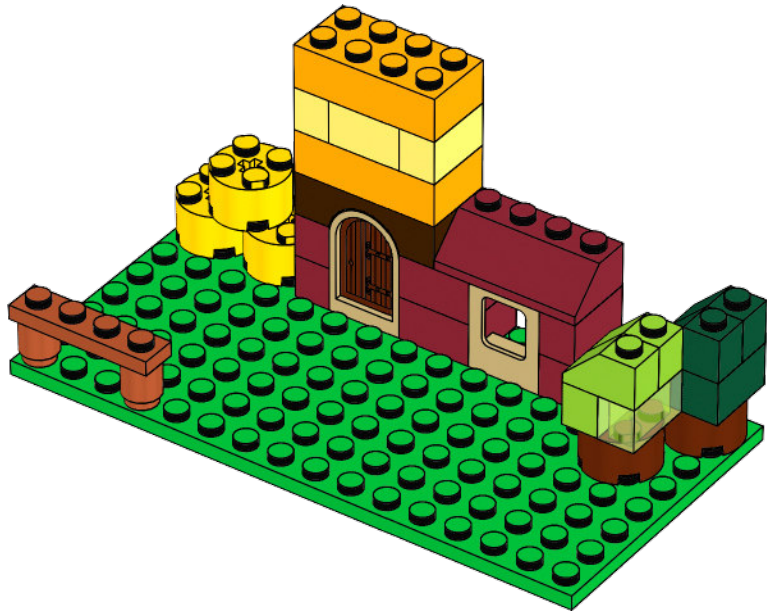



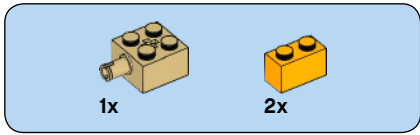

18

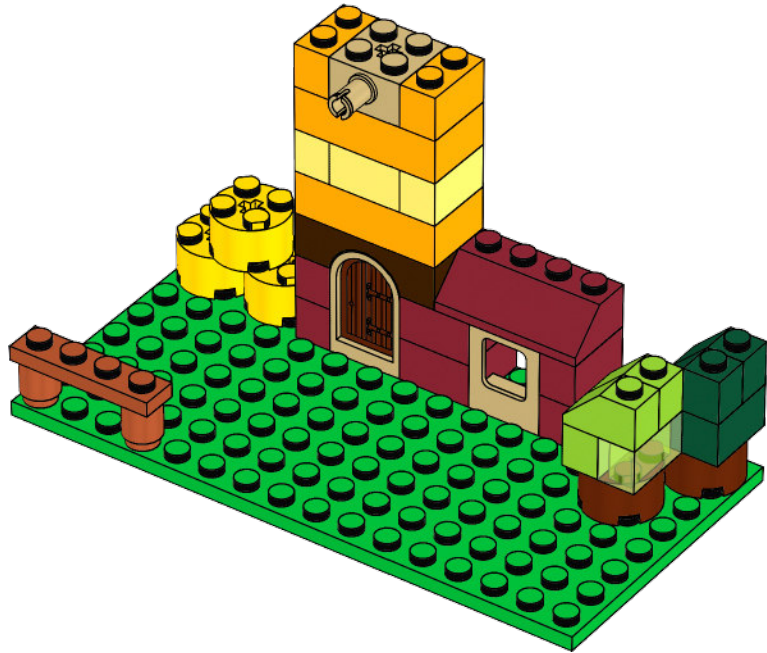

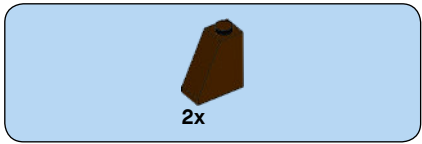

19

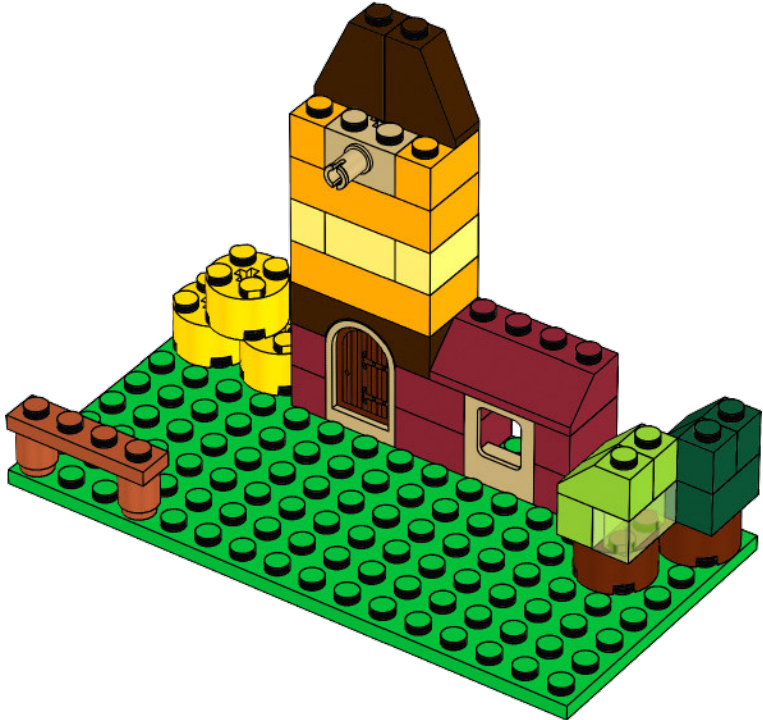

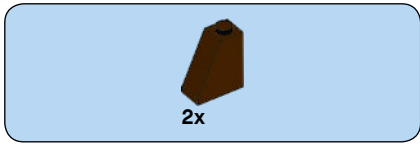

20

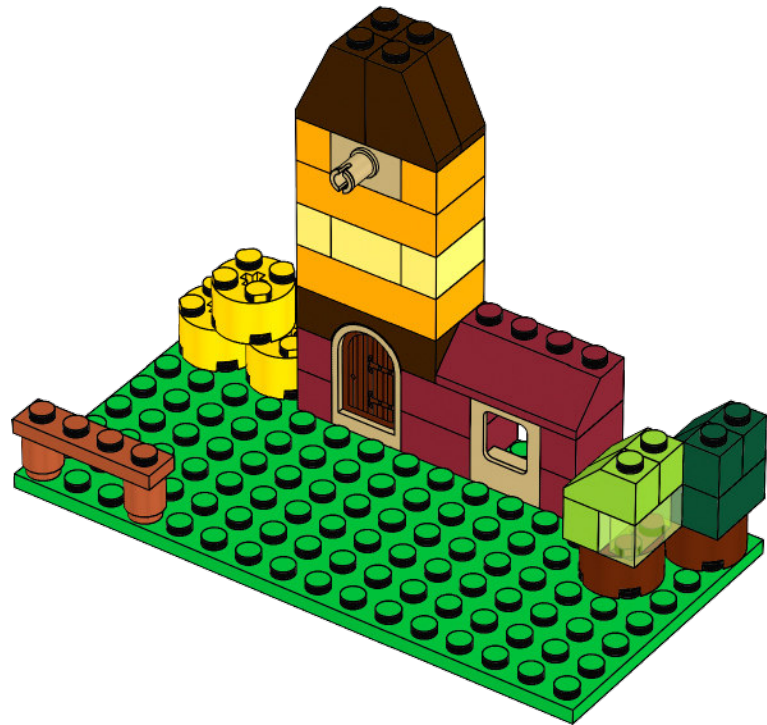

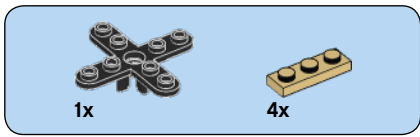

# 21

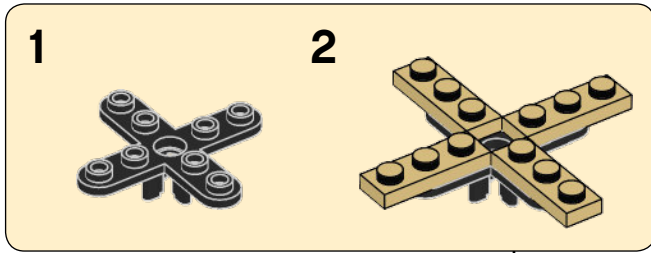





# CLASSIC

7 [LEGO.com](https://www.lego.com)

10696





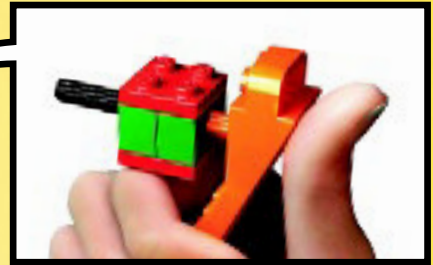

[LEGO.com/brickseparator](https://LEGO.com/brickseparator)





Easy building  
Einfach zu bauen  
Construction facile  
Construcción fácil  
Construção fácil  
Kezdő építőknek  
简单拼砌



Medium building  
Mittelschwer  
Construction intermédiaire  
Construcción intermedia  
Construção intermédia  
Gyakorló építőknek  
中级拼砌



Advanced building  
Fortgeschritten  
Construction avancée  
Construcción avanzada  
Construção avançada  
Tapasztalt építőknek  
高级拼砌



[LEGO.com/classic](http://LEGO.com/classic)



Page/页码

46



Page/页码

11



Page/页码

6





Page/页码

16



Page/页码

21



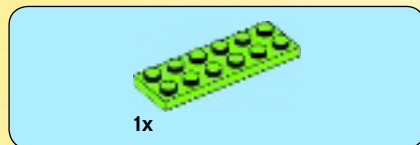

1

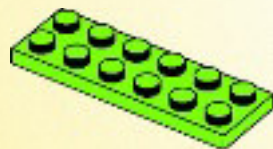



2x

2

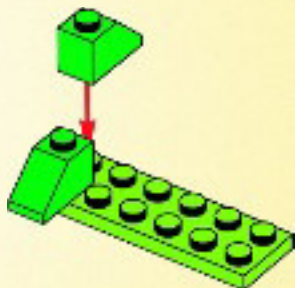

1x

3

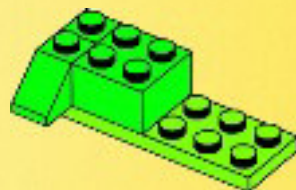



2x

4

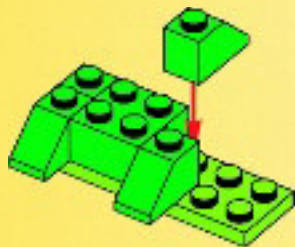

2x

5

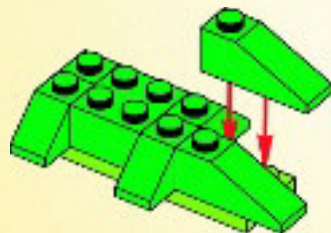

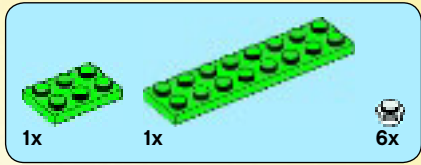

6

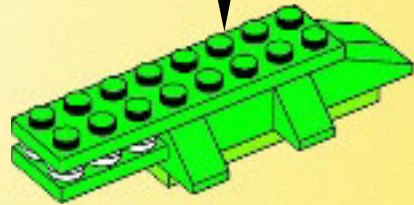
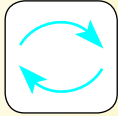
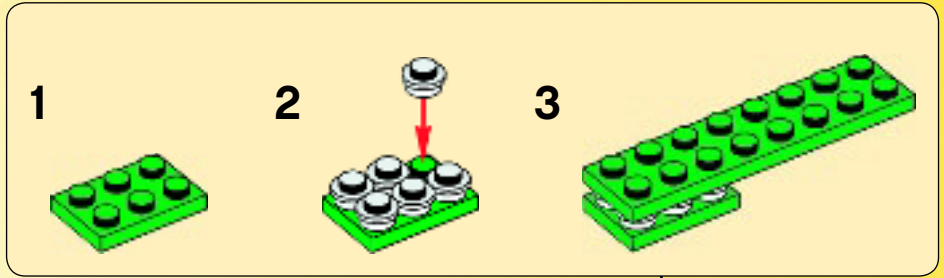



4x

7

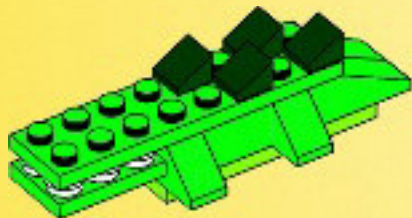

2x



2x

8

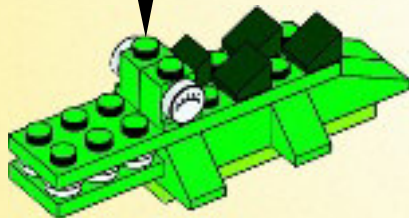
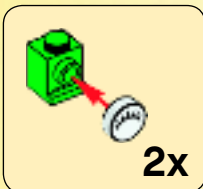



1







2x

2

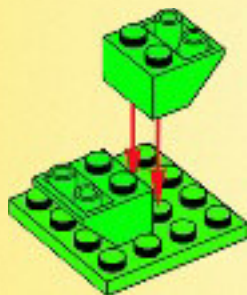



1x

3



1x

4





1x



1x

5



4x



4x

6

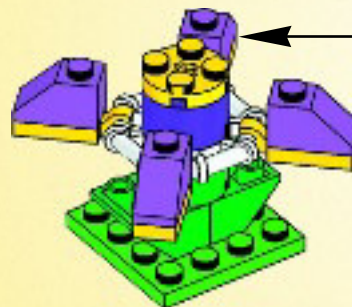

4x



7

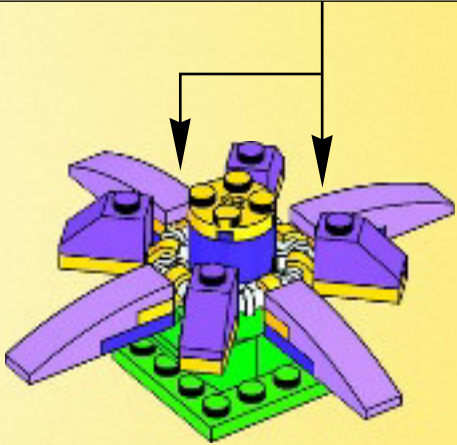
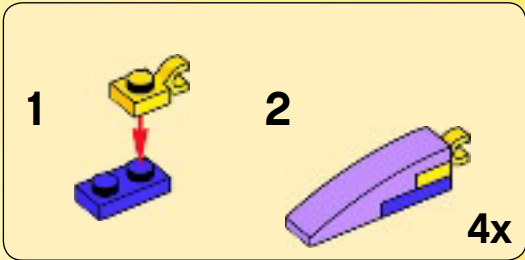



1





1x

2



1x

3





2x

4

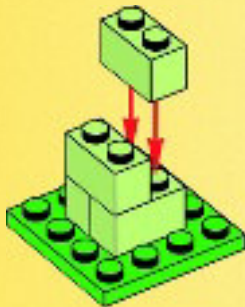

1x

5

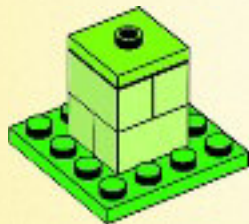



1x

6



1x



1x

7

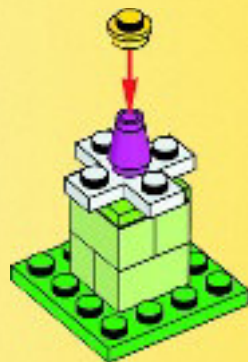



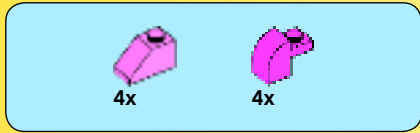

8

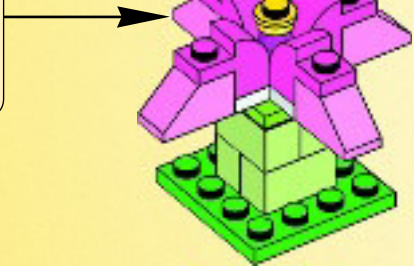
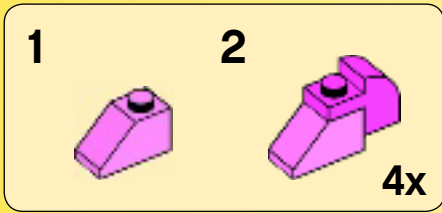

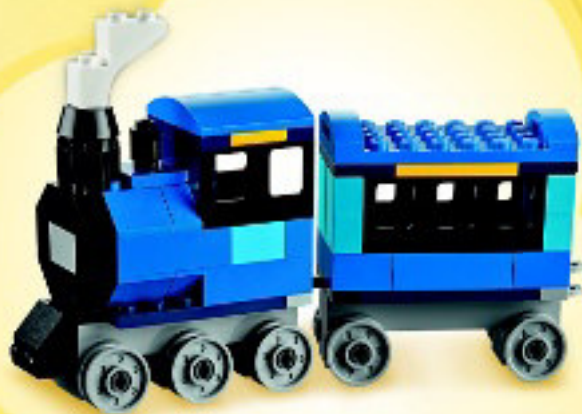

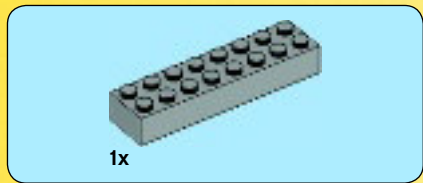

1

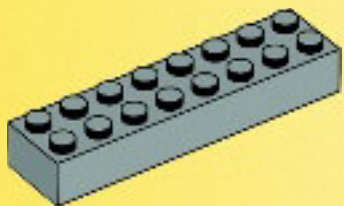

2

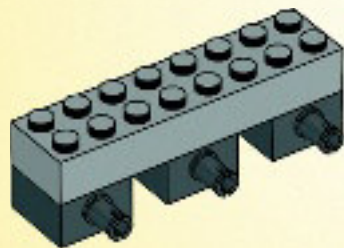



3

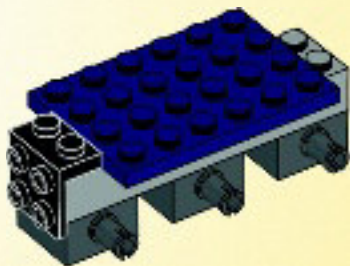

4

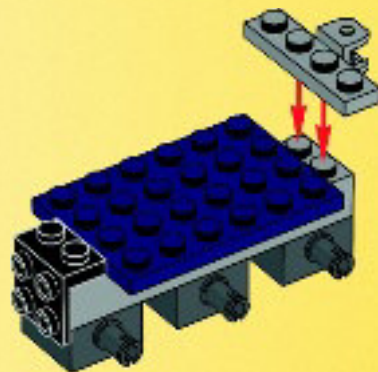



2x

5

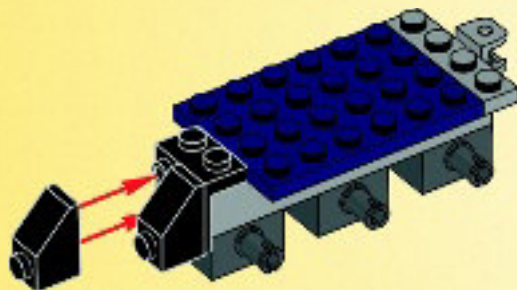



1x



2x

6

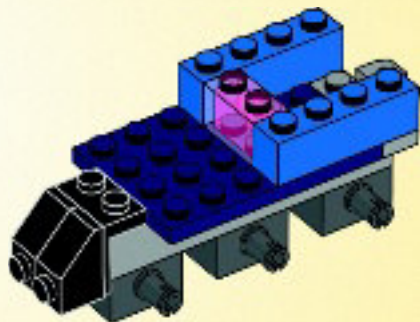

2x

7

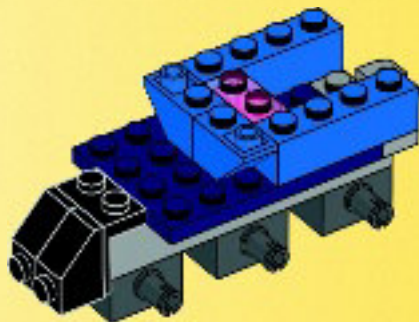



2x

8

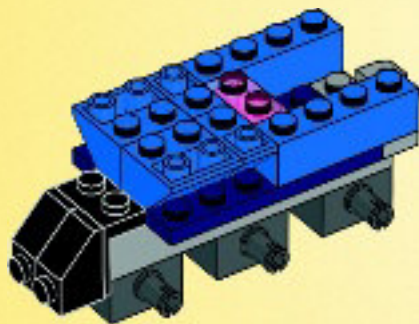



2x

9

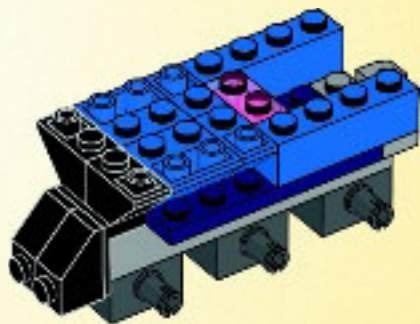

2x



2x

10

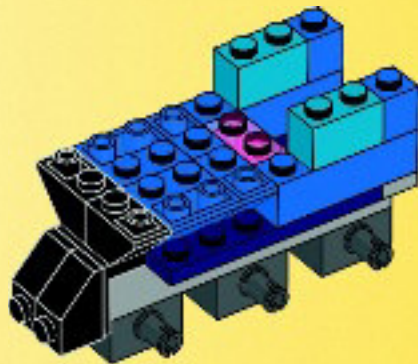





1x



1x

11

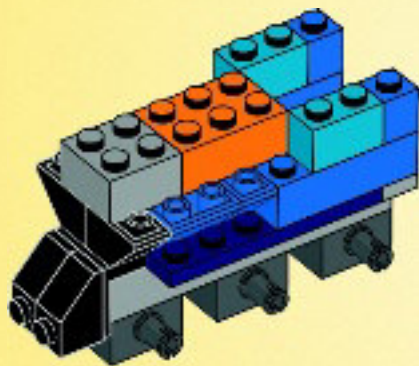



12

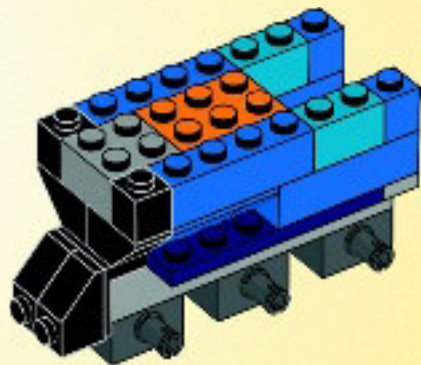

13

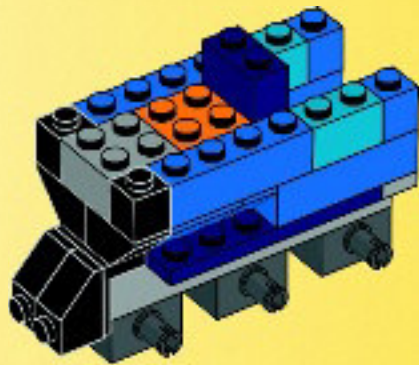



4x

14

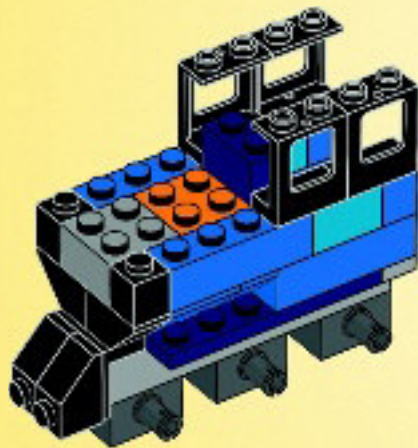



1x



2x

# 15

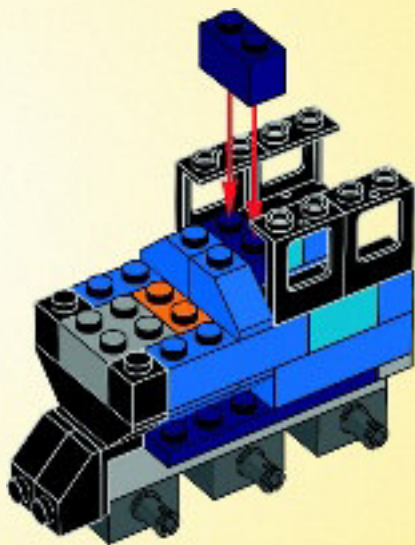

2x

# 16

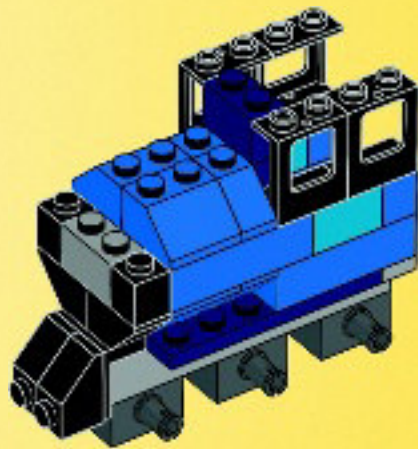



2x



1x

# 17

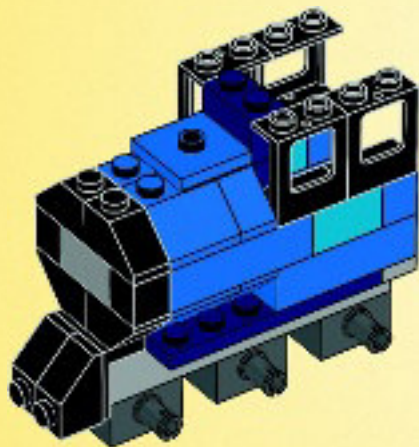



2x



2x

# 18

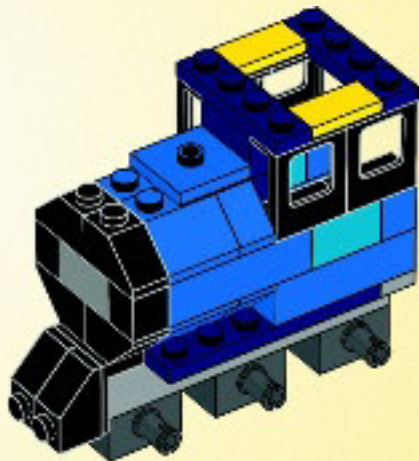

1x



1x

# 19

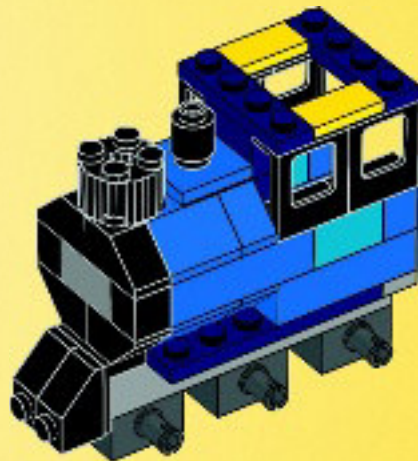



1x

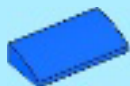

2x

# 20

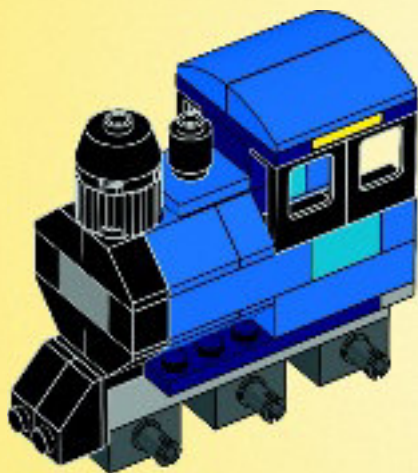



1x

21

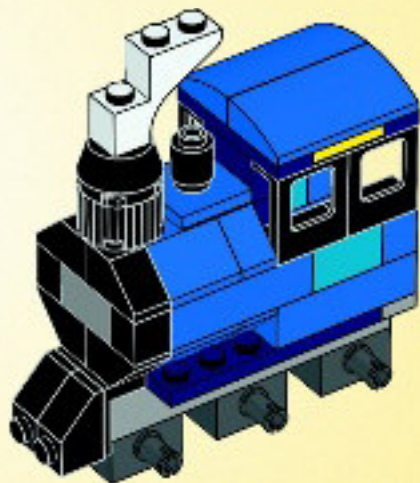

6x

22

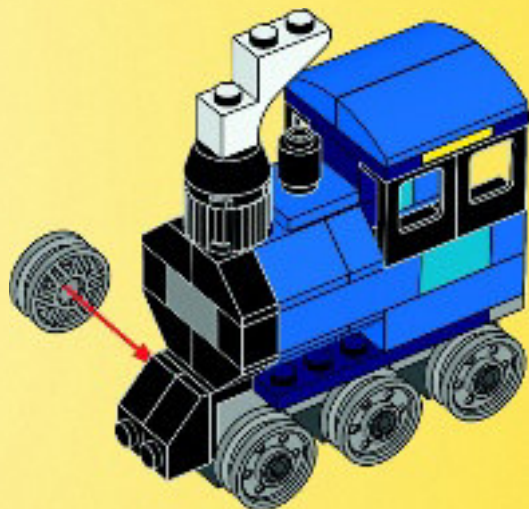



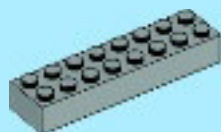

1x

1

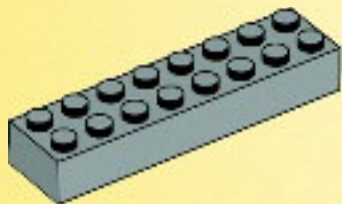

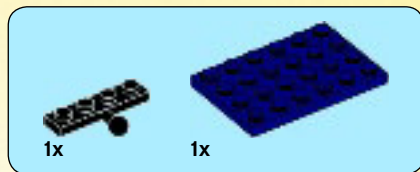

2

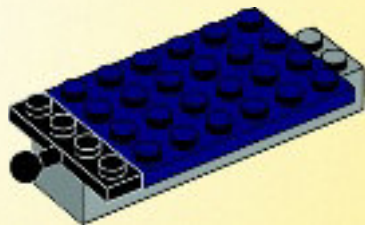

3

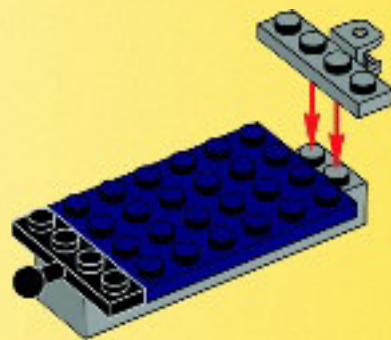



1x

4

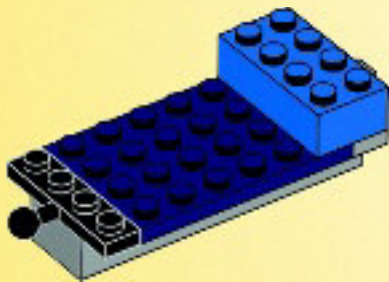

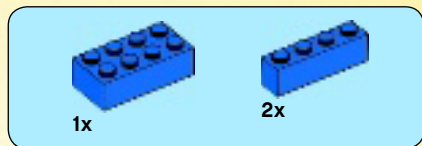

5

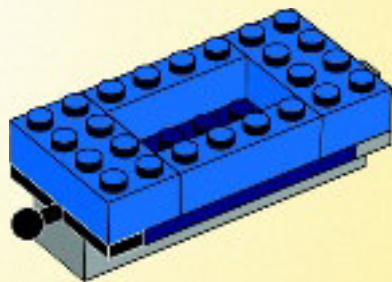

6

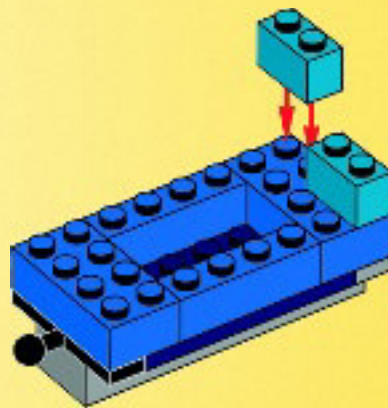



2x

7

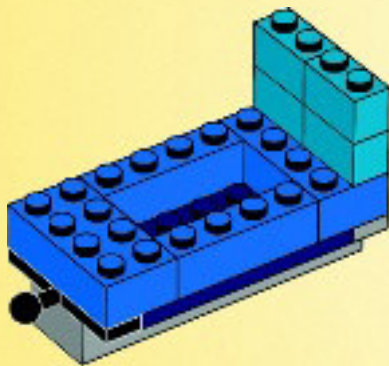



6x

8

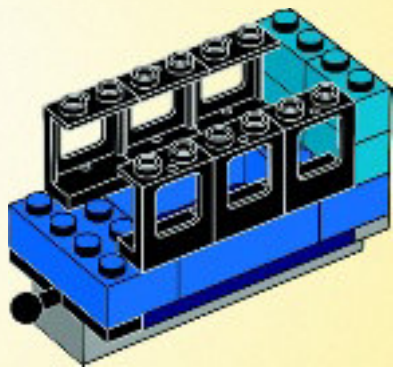

4x

9

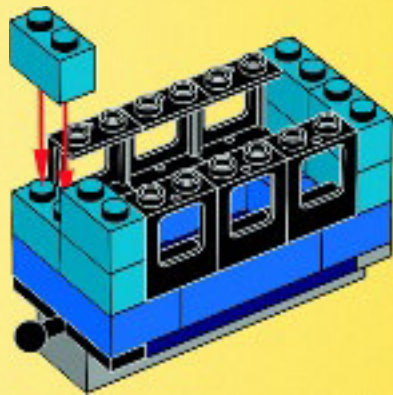



2x



2x

# 10

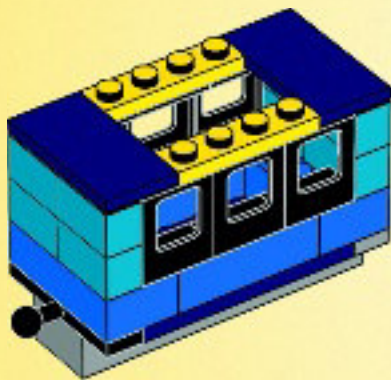



2x

11

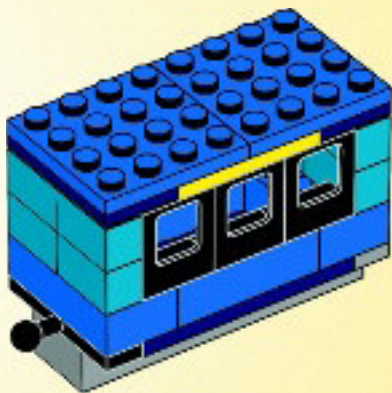

2x

12

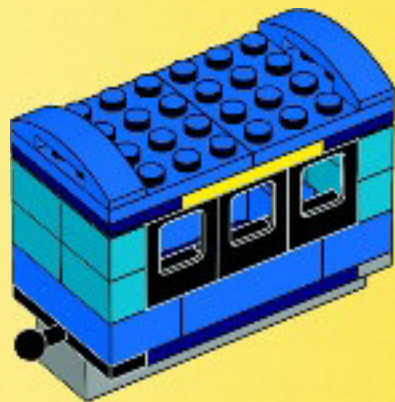





2x

13

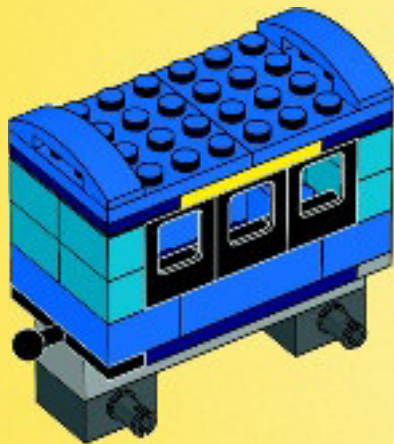

4x

14

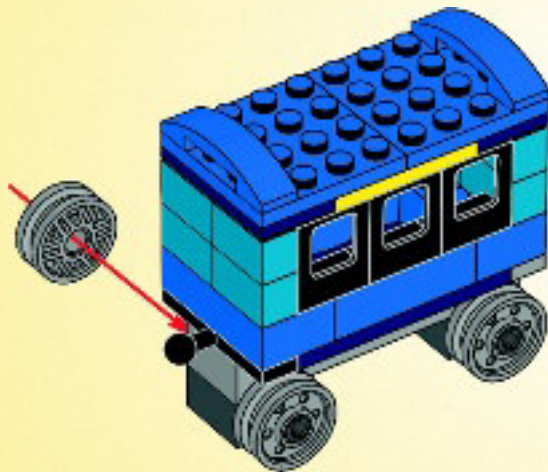

23

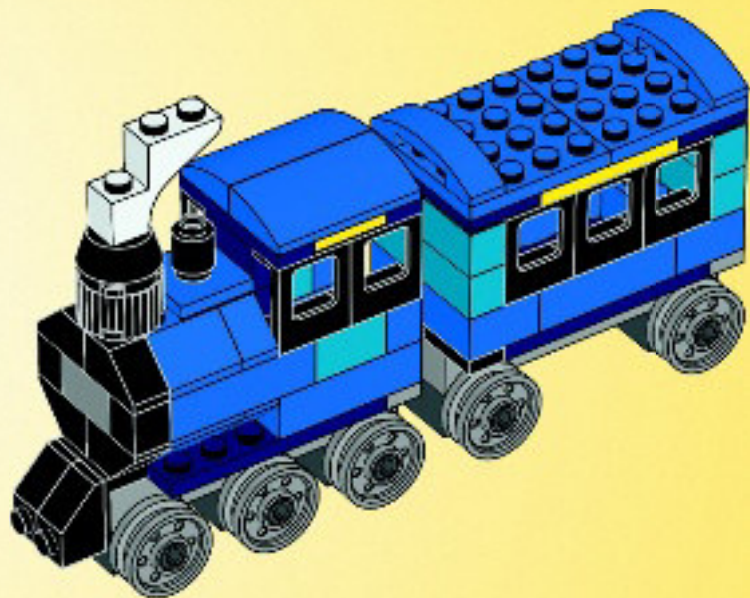



1x

1

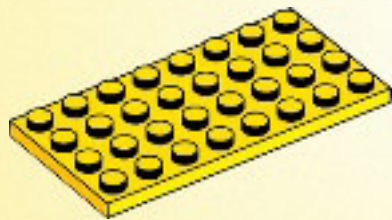



1x

2

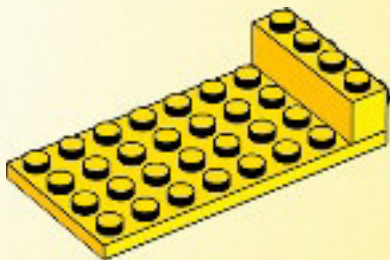

1x



1x



1x

3

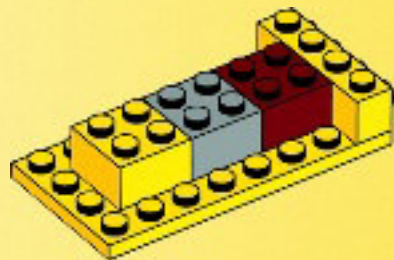

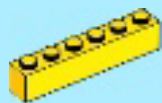

2x

4

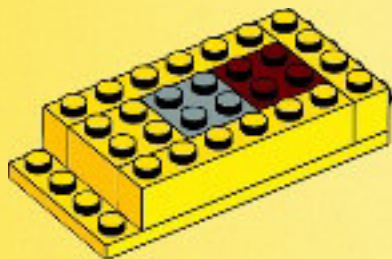

2x

1x

5

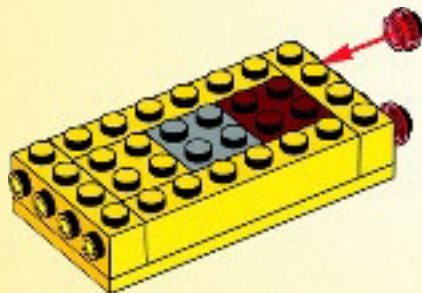



2x



1x

6

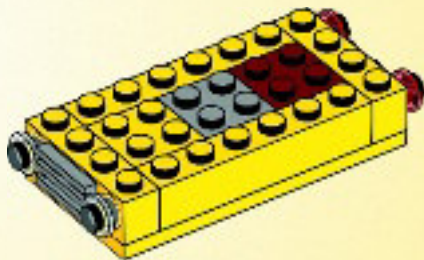

2x

7

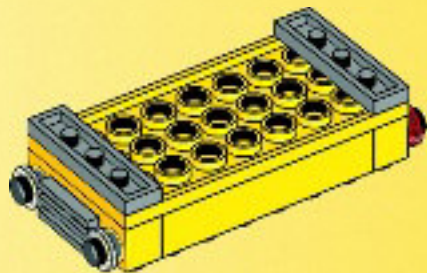
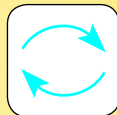



2x

8

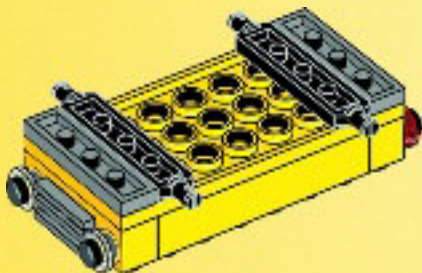

1x

9

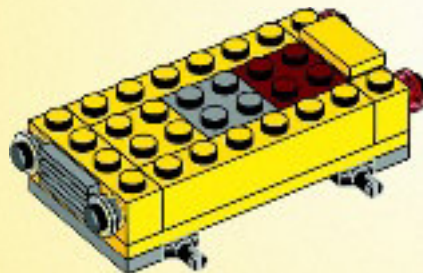
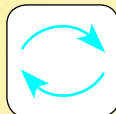



2x

10

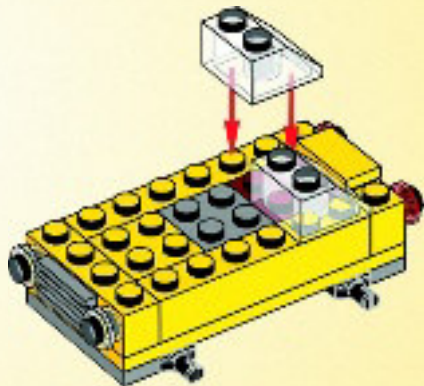

2x

11

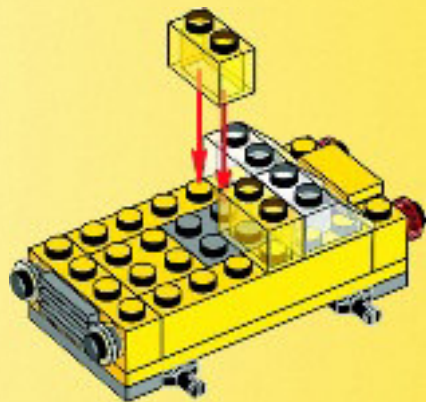





1x



2x

# 12



2x

# 13

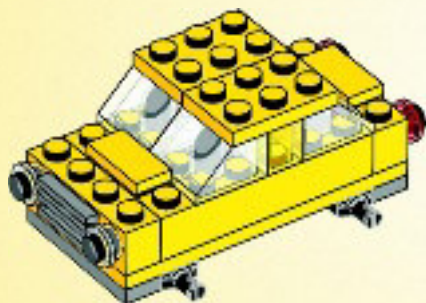



4x



4x

# 14

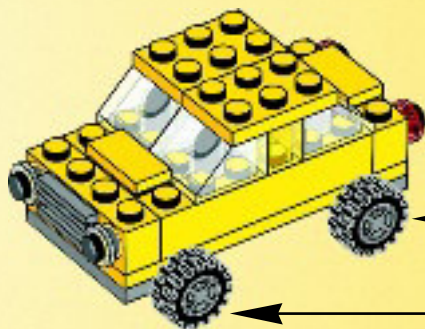

4x



**More ideas online:**  
[LEGO.com/classic](http://LEGO.com/classic)

More ideas online:  
Weitere Ideen online:  
Plus d'idées en ligne :  
Más ideas en Internet:  
Mais ideias online:  
Online még több ötletet találsz:  
更多在线构思:  
[LEGO.com/classic](http://LEGO.com/classic)



**LEGO CLASSIC**



10692



10693



10694



10696

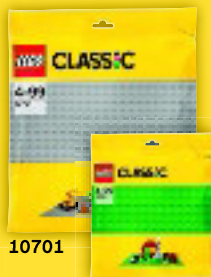

10701

10700

# LEGO CREATOR



31034



31031



31032



































































31033



3 IN 1

[LEGO.com/creator](http://LEGO.com/creator)

 4x 300401	 2x 302001	 4x 4113916	 1x 6036408	 2x 302321	 2x 4121936	 2x 300324	 1x 4549896
 2x 300101	 1x 379501	 1x 4185273	 3x 614321	 2x 302221	 2x 366023	 2x 300924	 1x 303524
 5x 303901	 1x 4515364	 4x 4121972	 2x 4651524	 2x 243121	 2x 303923	 2x 4164073	 4x 4540040
 2x 4500469	 1x 6009016	 4x 4121921	 2x 4121934	 1x 368021	 2x 303923	 2x 4164073	 4x 4535740
 1x 4568956	 6x 614101	 1x 4543947	 4x 609121	 2x 300523	 2x 4649773	 3x 614324	 2x 614124
 1x 4568956	 2x 6029156	 1x 4543947	 2x 6029946	 6x 301023	 2x 4651237	 4x 306924	 1x 403224
 1x 621501	 2x 6097402	 1x 4623514	 1x 621521	 2x 300123	 1x 4565319	 2x 302124	 3x 300526
 1x 6099412	 2x 6099548	 2x 300121	 2x 241221	 2x 366523	 2x 4243815	 2x 371024	 1x 4288212

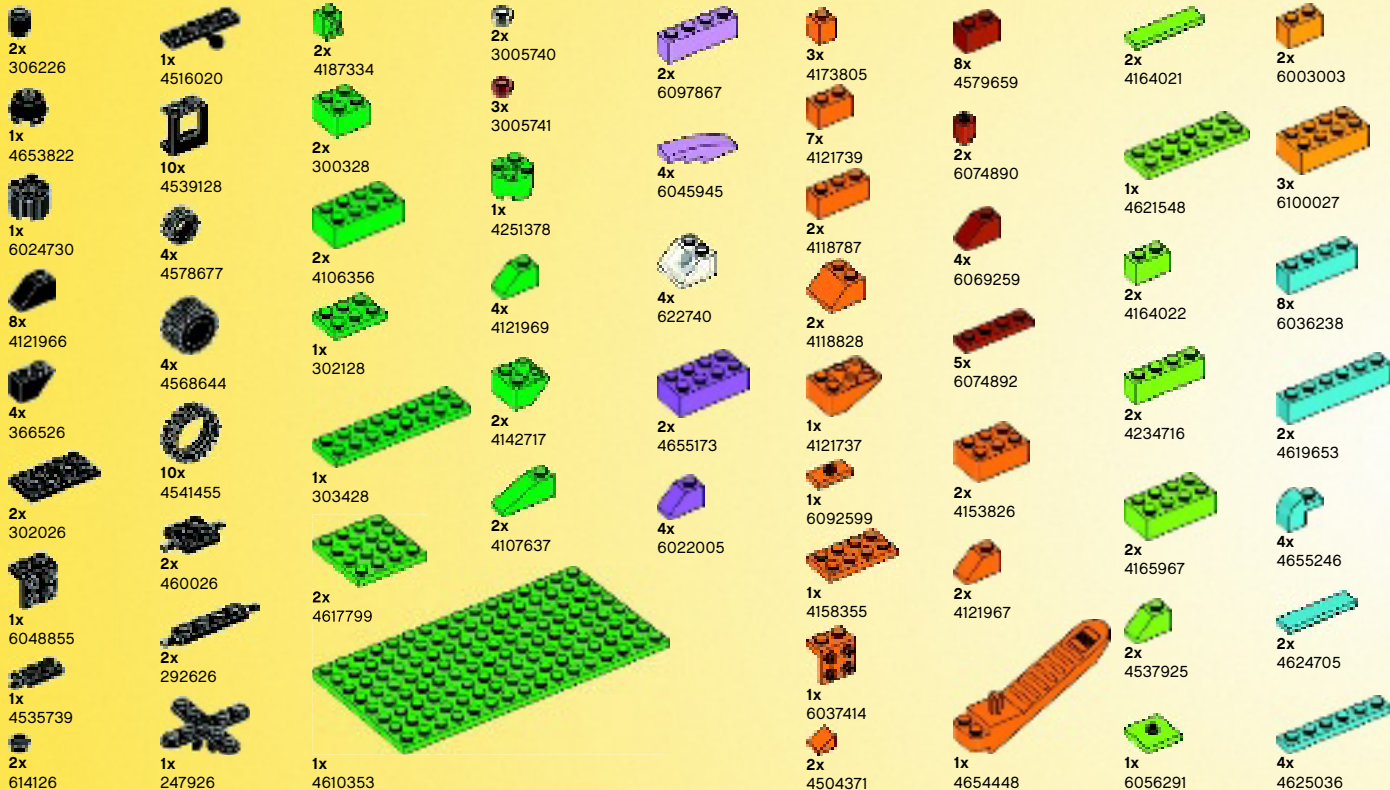



2x  
4211085



2x  
4211044



3x  
4529240



5x  
4211024



4x  
4211096



1x  
4210794



2x  
4517992



4x  
6056413



2x  
4623775



4x  
4624089



2x  
4520632



4x  
4517995



4x  
6022083



2x  
4626935



2x  
4622176



4x  
4655695



16x  
6004943



2x  
4655172



4x  
6004938



4x  
6104578



4x  
6022032



2x  
4619815



2x  
4616211



2x  
6096995



2x  
306544



2x  
4211445



2x  
4211395



2x  
4667166



4x  
4211506



4x  
4211764



10x  
6044729



1x  
4540203



2x  
6007894



3x  
4211387

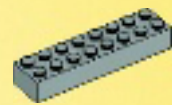

2x  
6037399



2x  
4211494



4x  
4211350



4x  
4251163



2x  
4211201



2x  
4216668



2x  
4245570



2x  
4260493



4x  
4504375



2x  
4255624



2x  
4211166



1x  
4624507



2x  
6056373



2x  
6003007



2x  
4249891



2x  
4502089



2x  
4569836



2x  
6037887



4x  
4539102



3x  
4539104



1x  
4541380



3x  
4539097



2x  
4539061



2x  
4642409



**Customer Service**

**Kundenservice**

**Service Consommateurs**

**Servicio Al Consumidor**

**LEGO.com/service or dial**



**: 00800 5346 5555**

**: 1-800-422-5346**