



CITY

60052





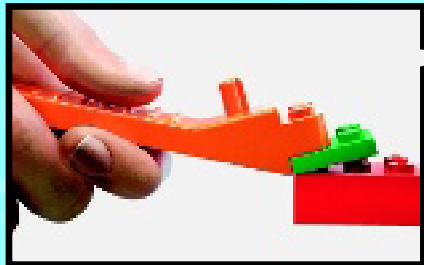
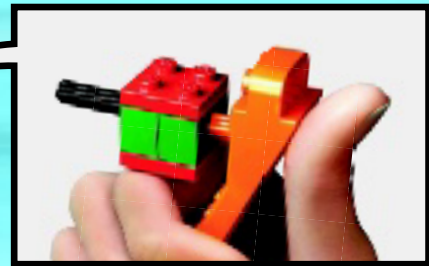
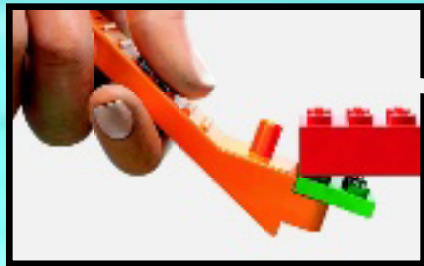

LEGO.com/brickseparator

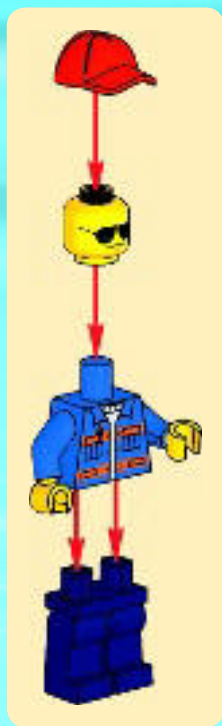



1x



1x

1



1



2





1x



1x

2

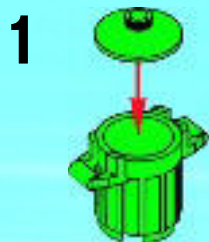

1x



1x

3

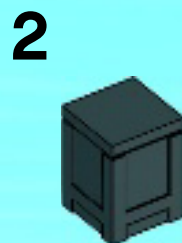
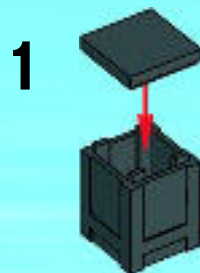

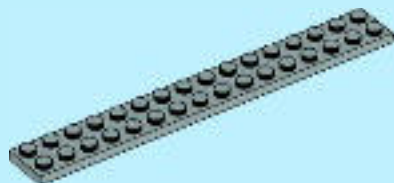

1x

1

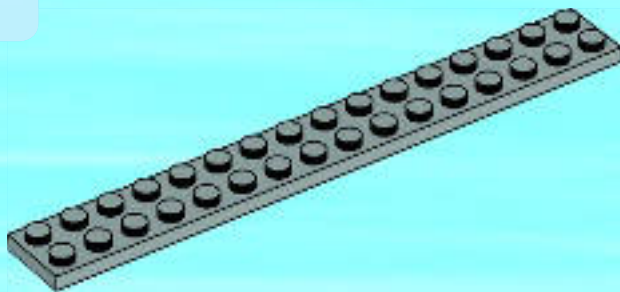



1x



2x

2

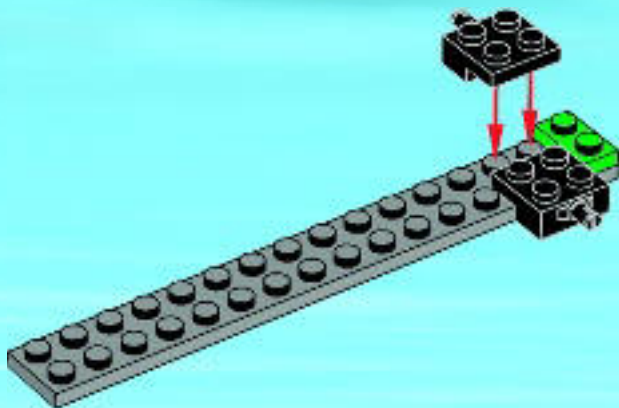



2x

3

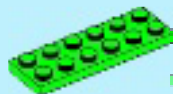
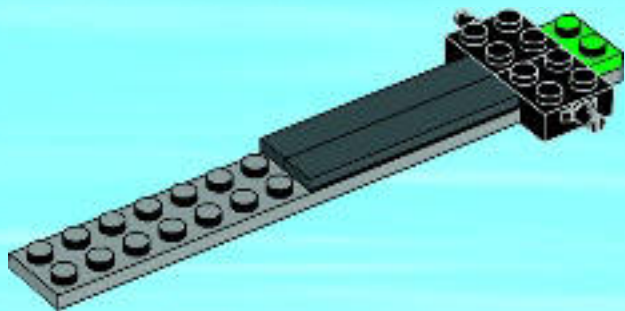

1x



1x



1x

4

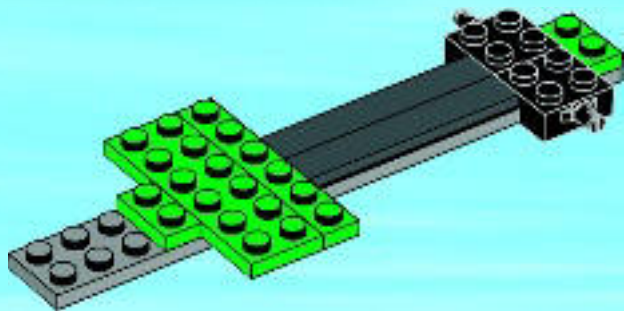



1x



2x

5

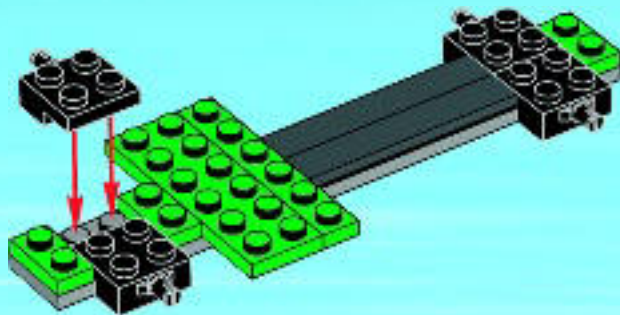

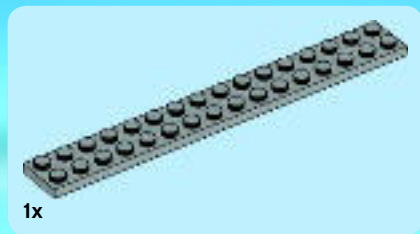

1x

6

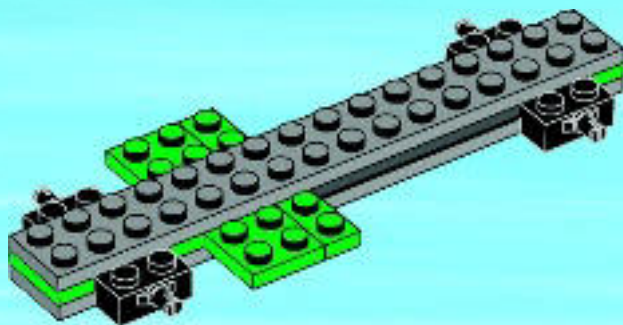



2x

7

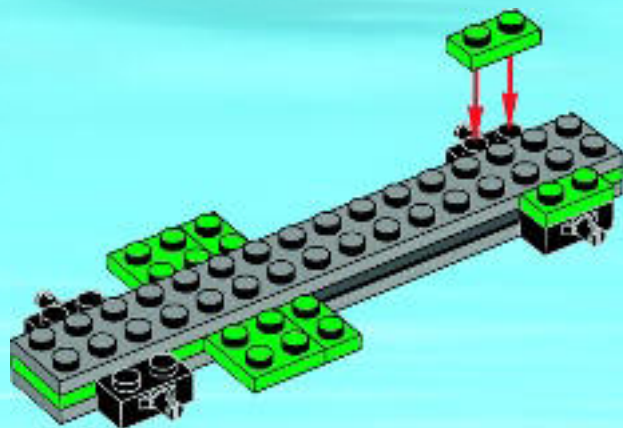



1x



1x

8

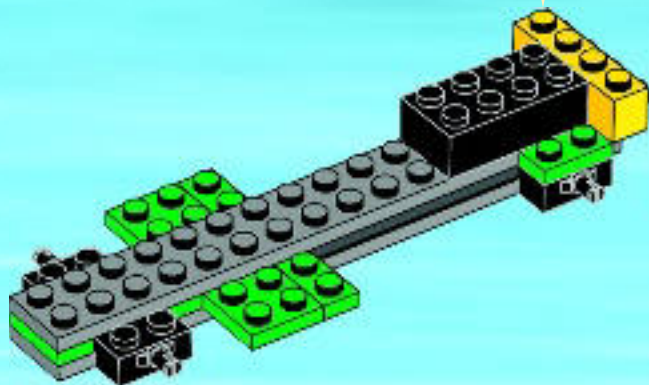
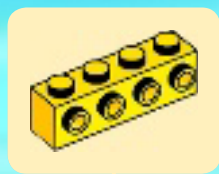



2x

9

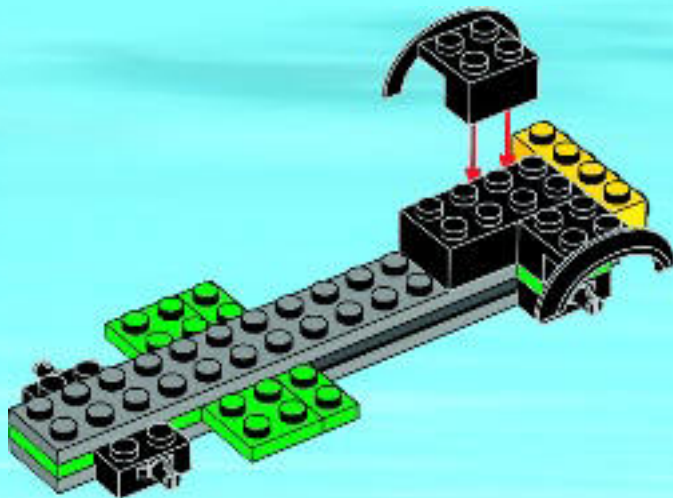



2x



2x



2x

10

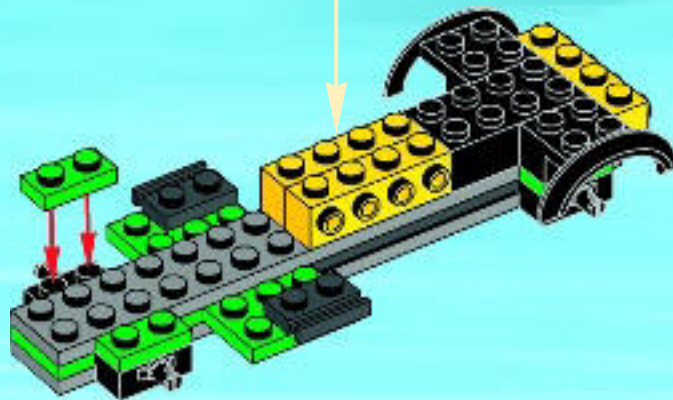
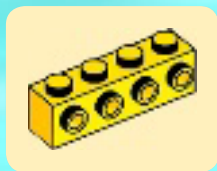



1x



2x

11

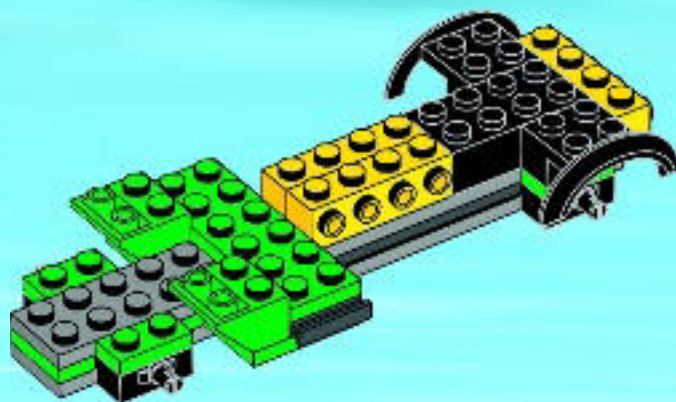



2x



1x

12

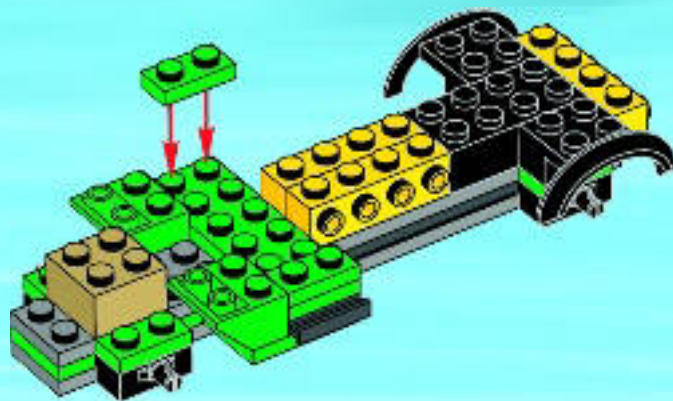



13

1

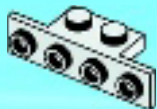

2

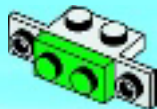

3



4



5

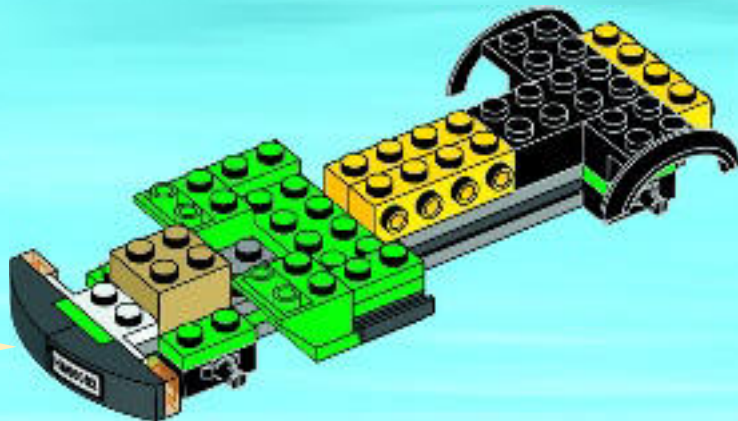



1x



1x

14

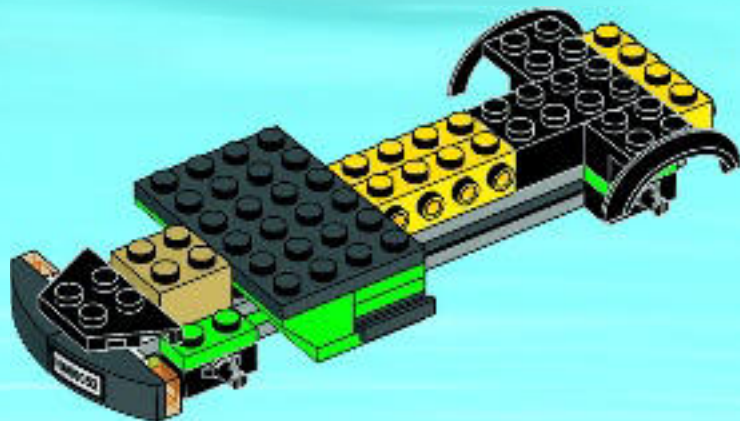



2x

15

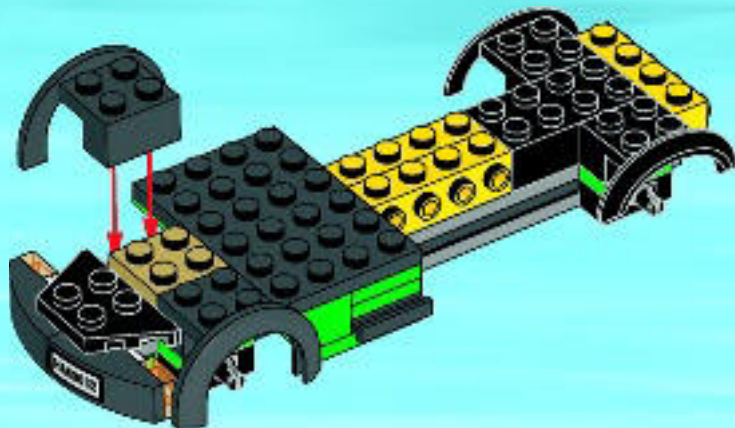



2x



1x



1x

16



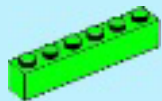

1x



1x



1x

17

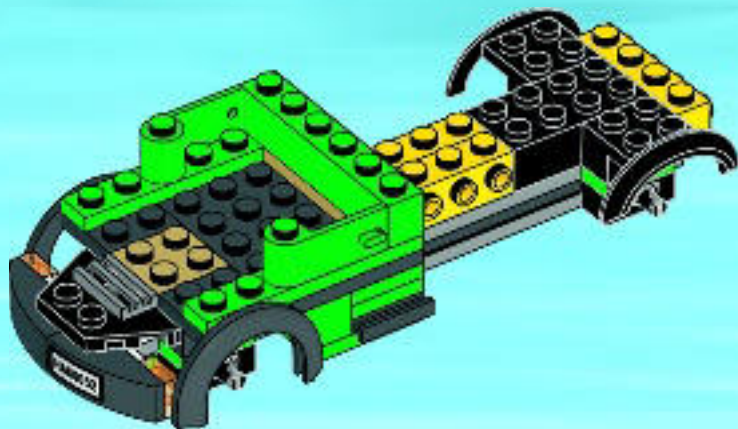



1x

18

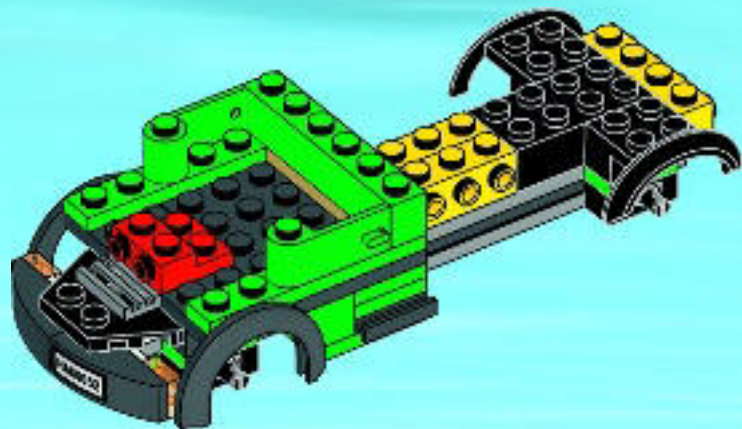



1x



1x

19

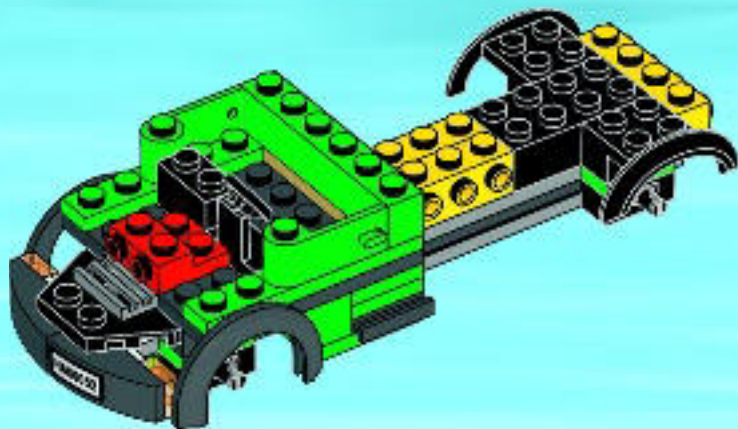



2x



2x

20

1

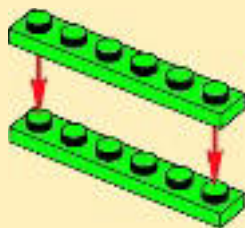

2

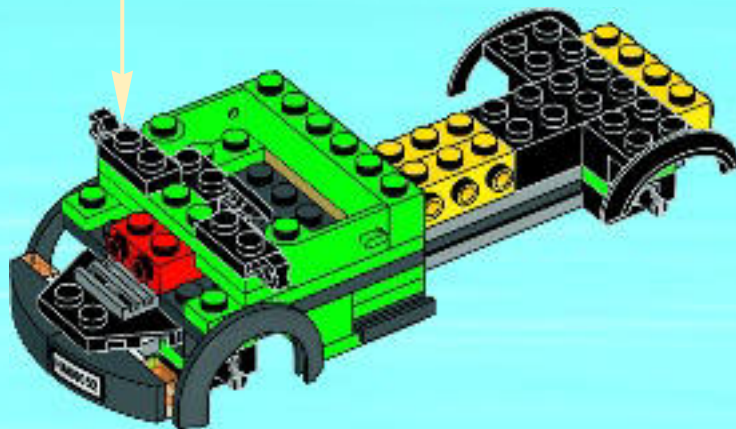
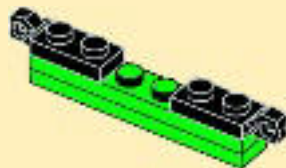



1x

21

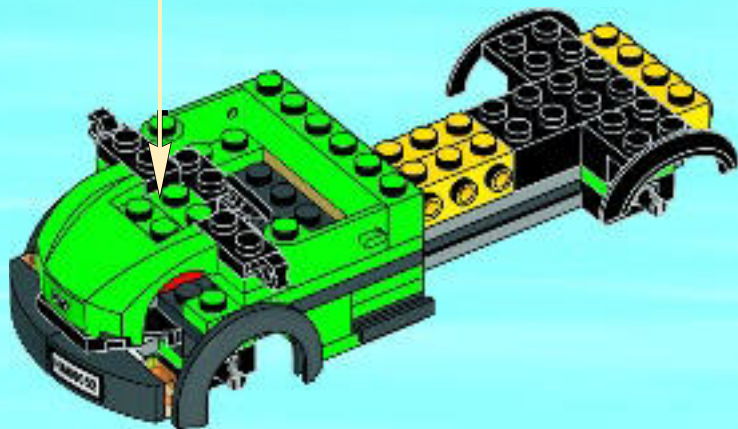



1x

22

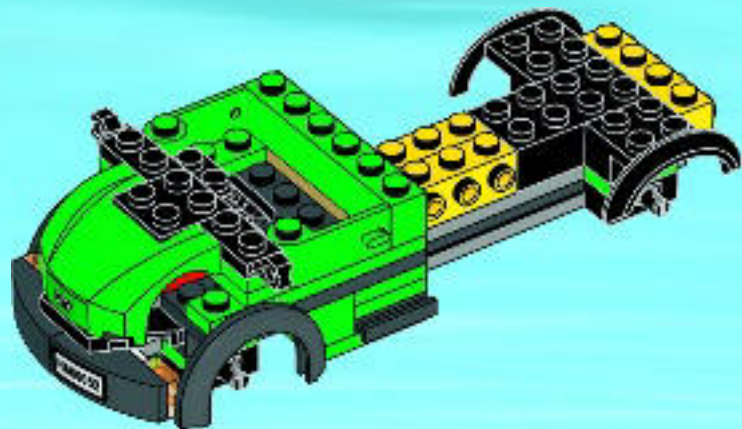



1x



2x

23

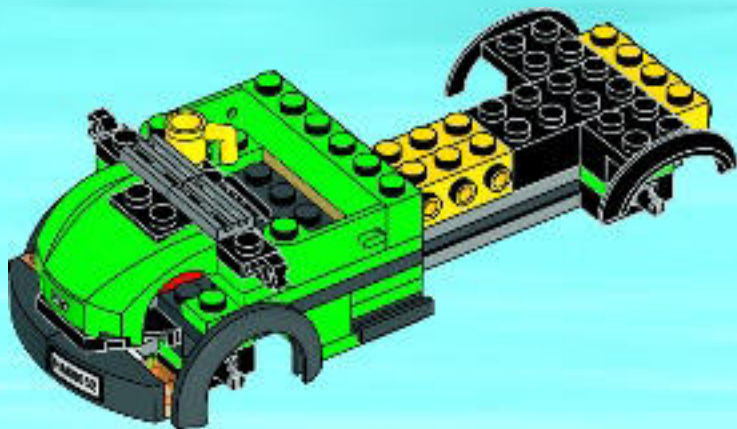



1x



1x



1x

1

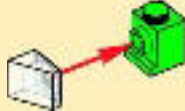

2



24

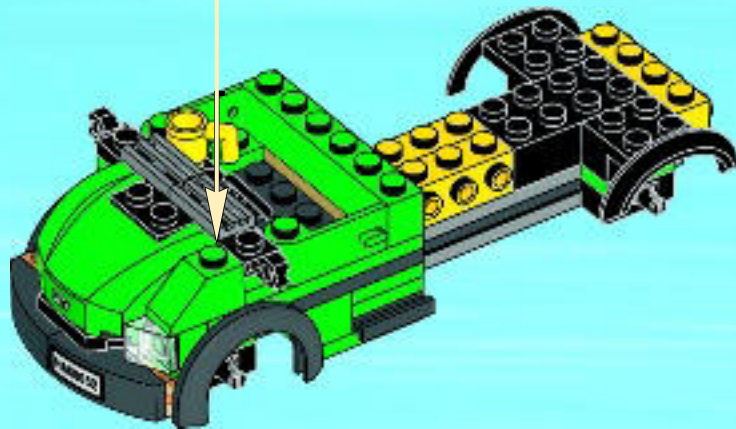



1x



1x



1x

1

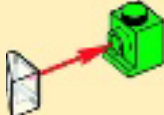

2



25

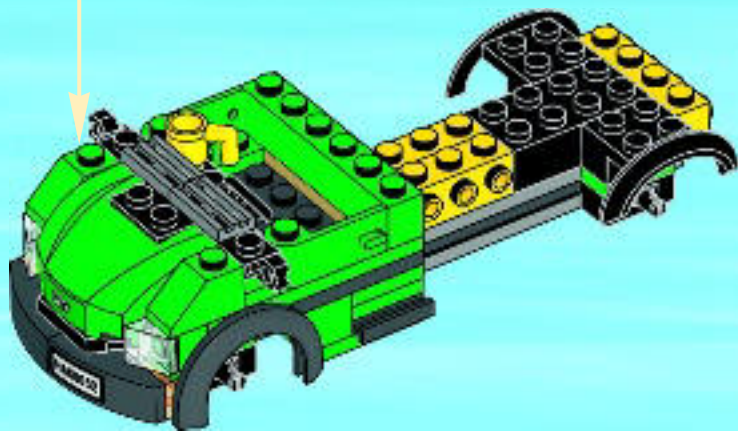

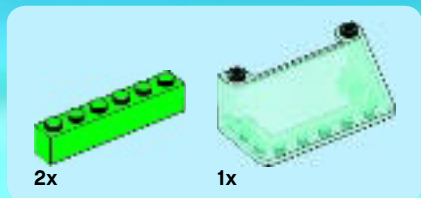

26

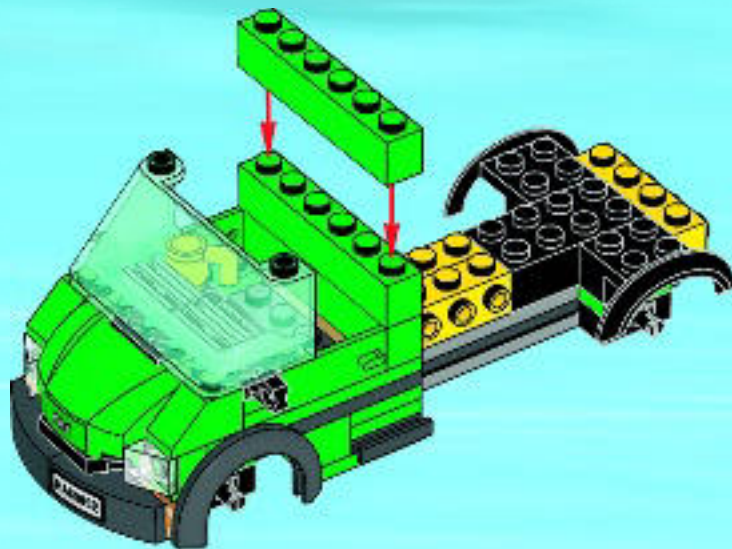



1x

1

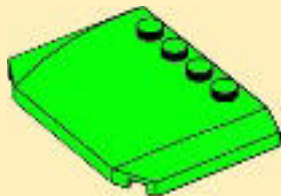

2



27

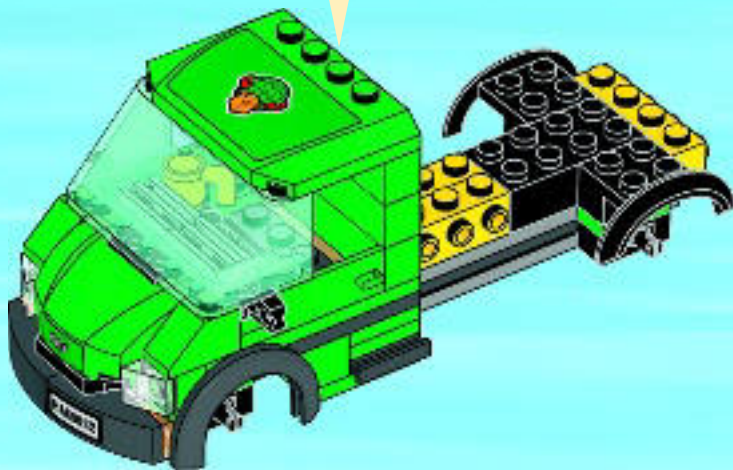



1x

1

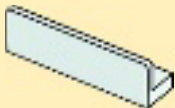

2



28

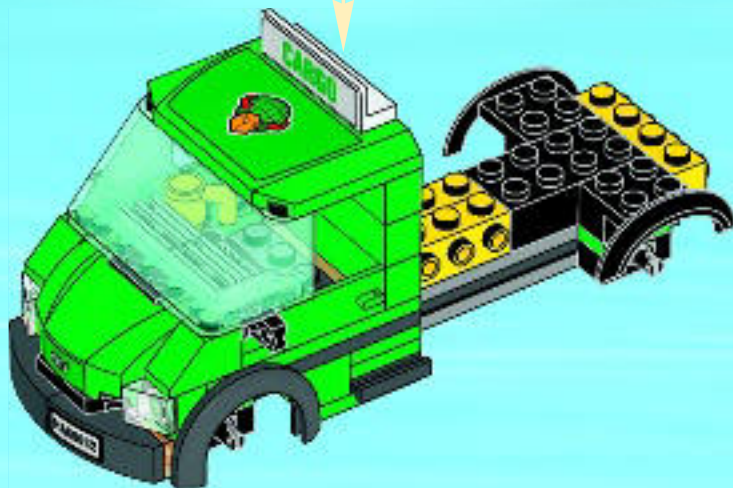



2x



2x



2x



2x



2x

29

1



2



3

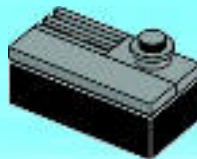

2x

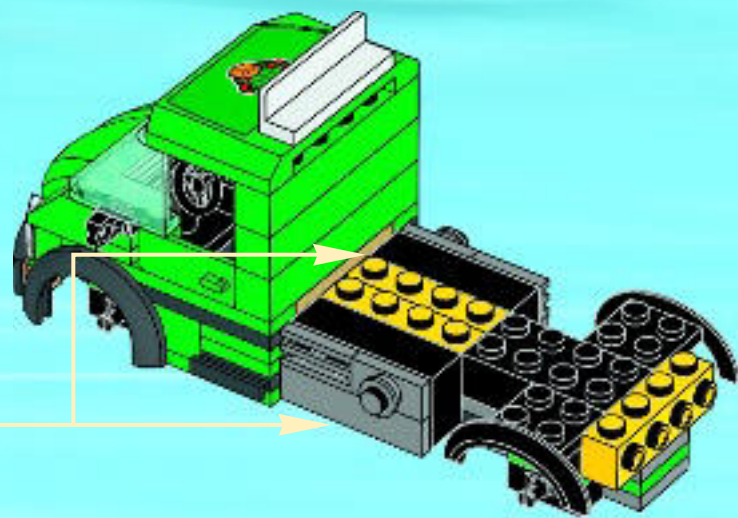



1x



2x



2x

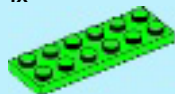

1x



1x

30

1

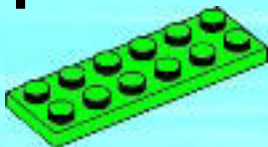

2

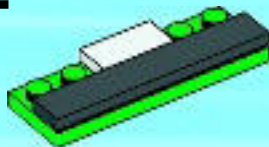

3

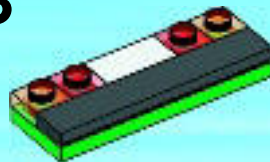

4

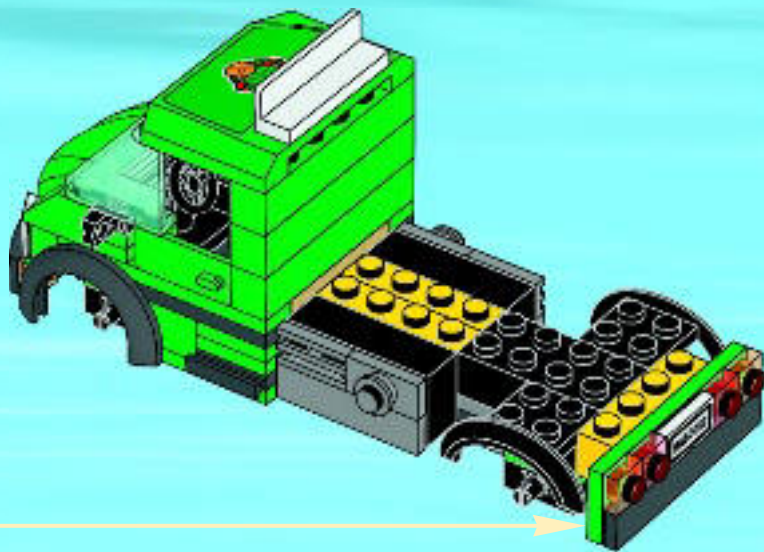
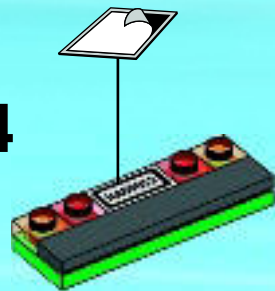

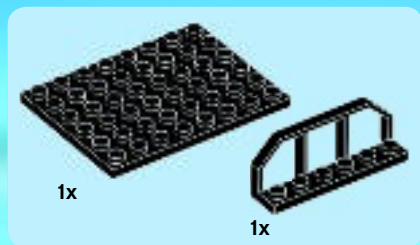

31

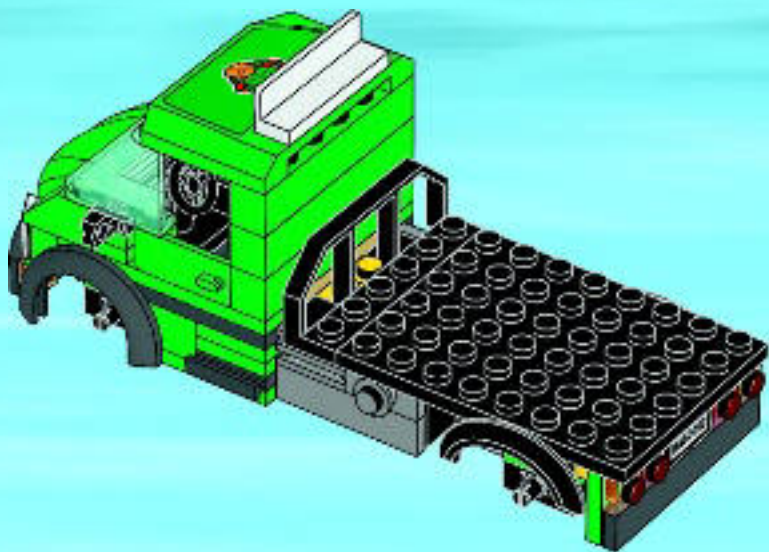



4x

32

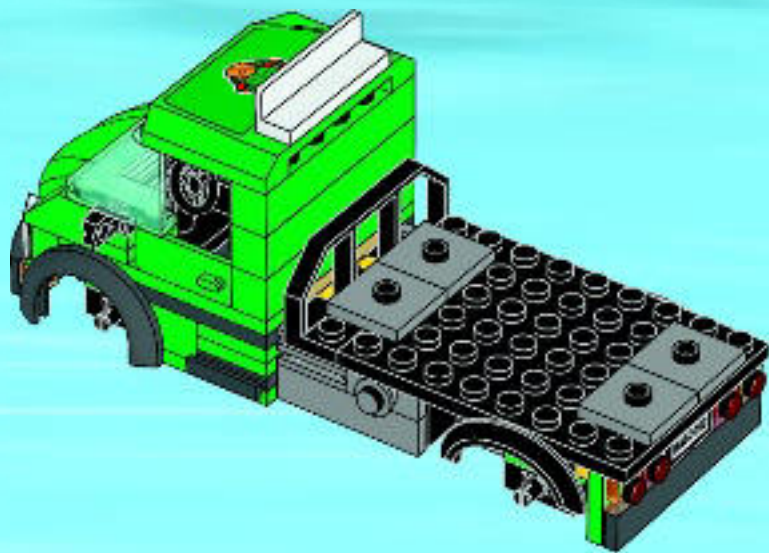



2x



2x

33

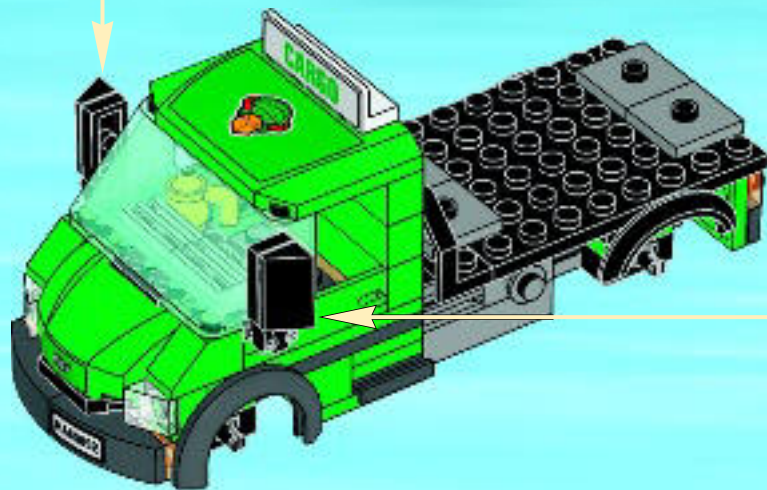



4x



4x

34

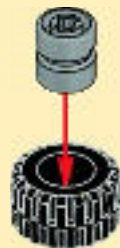

4x

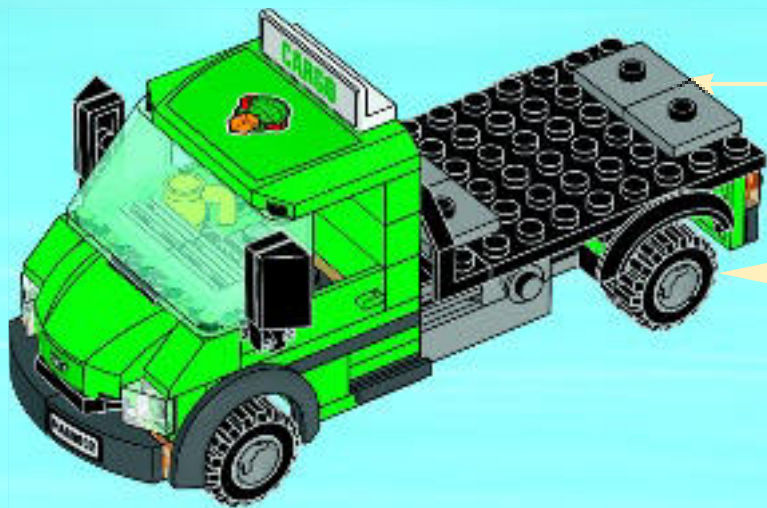

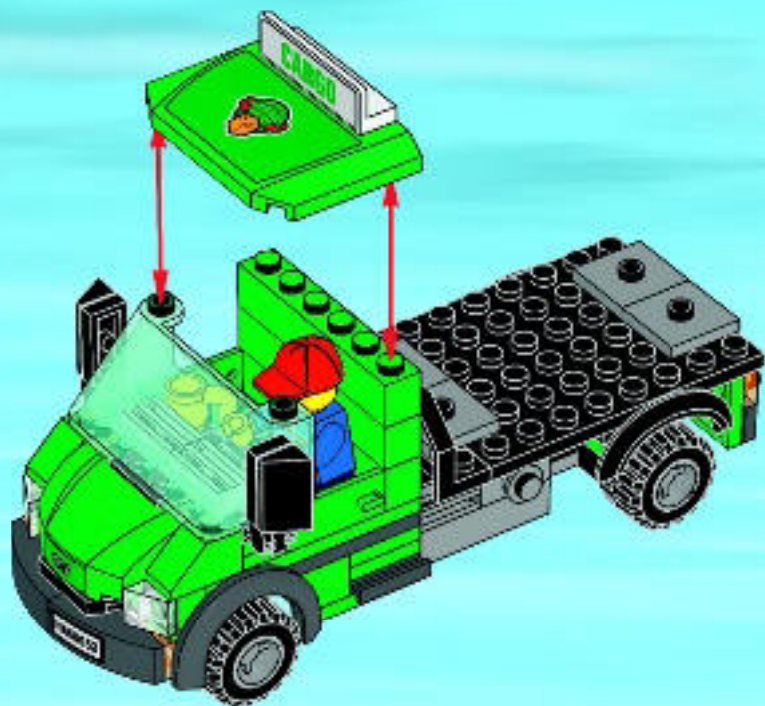



CITY

60052



EN

Important information about batteries

Never use different types of batteries together, or a combination of old and new batteries. Always remove the batteries if the product is not to be used for a long time or if the batteries have run down. Never use damaged batteries. Only use batteries of the type recommended, or a corresponding type. Insert the batteries so that the poles are correctly positioned. Rechargeable batteries must be recharged using the correct battery charger under the supervision of an adult. You cannot recharge batteries while they are still in the product, and you must never try to do so. Never attempt to recharge non-rechargeable batteries. Never short-circuit the battery holder.

DE

Wichtige Information zu Batterien

Benutzen Sie niemals unterschiedliche Arten von Batterien oder alte und neue gleichzeitig. Nehmen Sie stets die Batterien heraus, wenn mit dem Modell längere Zeit nicht gespielt wird oder wenn die Batterien leer sind. Verwenden Sie niemals beschädigte Batterien. Verwenden Sie ausschließlich empfohlene bzw. geeignete Batterien. Achten Sie beim Einsetzen der Batterien auf die richtige Polung. Wiederaufladbare Batterien sollten mit einem geeigneten Ladegerät aufgeladen werden – unter Aufsicht eines Erwachsenen. Wiederaufladbare Batterien können und sollten niemals aufgeladen werden, während sie sich im Modell befinden. Versuchen Sie unter keinen Umständen, „normale“ Batterien wieder aufzuladen. Schließen Sie das Batteriefach niemals kurz.

FR

Informations importantes concernant les piles

Ne jamais utiliser un mélange de différents types de piles, ou de piles neuves et de piles anciennes ou déjà utilisées. Toujours retirer les piles si le produit n'est pas utilisé durant une période prolongée ou si les piles sont vides. Ne jamais utiliser de piles endommagées. Utiliser uniquement des piles du type recommandé ou d'un type équivalent. En insérant les piles, respecter scrupuleusement le sens d'orientation des pôles (+/-). Les piles rechargeables doivent être rechargées en utilisant un chargeur de piles adéquat et sous la surveillance d'un adulte. Il est impossible de recharger les piles quand elles sont installées dans le produit. Ne jamais tenter de le faire. Ne jamais essayer de recharger des piles non-rechargeables. Ne jamais court-circuiter le compartiment des piles.

IT

Importanti informazioni sulle batterie

Non usare mai contemporaneamente batterie di tipo diverso o batterie nuove e usate insieme. Rimuovere sempre le batterie qualora il prodotto non venga utilizzato per periodi prolungati, oppure se le batterie sono esauste. Non utilizzare mai batterie danneggiate. Usare esclusivamente batterie del tipo raccomandato o un equivalente. Inserire le batterie avendo cura che la loro polarità sia corretta. Le batterie ricaricabili vanno ricaricate in un caricabatterie di tipo idoneo e con la supervisione di un adulto. Non è possibile e non bisogna mai tentare di ricaricare le batterie mentre queste sono inserite nel prodotto. Non tentare mai di ricaricare batterie non ricaricabili. Non cortocircuitare mai il portabatterie.

NL

Belangrijke informatie over batterijen

Gebruik nooit verschillende soorten of een combinatie van oude en nieuwe batterijen tegelijkertijd. Verwijder de batterijen altijd als je het product lange tijd niet wilt gebruiken of als de batterijen leeg zijn. Gebruik nooit beschadigde batterijen. Gebruik uitsluitend batterijen van het aanbevolen type of een overeenkomstig type. Plaats de batterijen met de polen in de juiste richting. Oplaadbare batterijen moeten in een voor dit doel bestemde oplader en onder toezicht van een volwassene opnieuw worden opgeladen. Oplaadbare batterijen kunnen niet worden opgeladen terwijl ze zich nog in het product bevinden en dit mag ook nooit worden geprobeerd. Probeer nooit niet-oplaadbare batterijen opnieuw op te laden. Laat de batterijhouder nooit kortsluiten.

ES

Información importante acerca de las pilas

No use pilas de diferentes tipos ni pilas nuevas y antiguas para alimentar el producto. Extraiga las pilas del producto si este va a permanecer sin uso durante un período prolongado de tiempo o aquellas se han agotado. No use pilas dañadas. Use sólo pilas del tipo recomendado u otro equivalente. Inserte las pilas de modo que los polos queden situados en las posiciones correctas. La carga de pilas recargables debe tener lugar empleando un cargador apropiado y bajo la supervisión de un adulto. Las pilas recargables no se pueden cargar mientras permanecen insertadas en el producto; no intente hacerlo. No trate de cargar pilas no recargables. No cortocircuite el compartimento de las pilas.

DA

Vigtige oplysninger om batterier

Brug aldrig forskellige batterityper sammen eller en kombination af gamle og nye batterier. Fjern altid batterierne, hvis produktet ikke skal bruges i lang tid, eller hvis batterierne er flade. Brug aldrig beskadigede batterier. Brug kun den anbefalede type batterier eller en tilsvarende type. Sæt batterierne i, så polerne vender den rigtige vej. Genopladelige batterier skal oplades i den rigtige batterioplader. Batterierne skal sættes i opladeren under opsyn af en voksen. Batterierne kan ikke oplades, mens de stadig sidder i produktet, og man må aldrig forsøge at gøre det. Forsøg aldrig at oplade ikke-genopladelige batterier. Kortslut aldrig batteriholderen.

FI

Tärkeää tietoa paristoista

Älä koskaan käytä erityyppisiä paristoja yhdessä. Älä myöskään käytä samassa laitteessa sekä vanhoja että uusia paristoja. Poista paristot tuotteesta aina, kun se on pitemmän aikaa käyttämättä, tai kun paristot ovat tyhjentyneet. Älä koskaan käytä viallisia paristoja. Käytä vain tuotteesta suositeltuja tai vastaavantyyppisiä paristoja. Aseta paristot siten, että navat osoittavat oikeaan suuntaan. Ladattavat paristot on ladattava oikeanlaisella laturilla aikuisen valvonnassa. Ne on poistettava tuotteesta lataamisen ajaksi. Älä koskaan yritä ladata paristoja, joita ei ole tarkoitettu ladattaviksi. Älä koskaan aiheuta oikosulkua pariston kosketinten välillä.

SV

Viktig information om batterier

Använd aldrig olika sorters batterier samtidigt, och inte heller en kombination av gamla och nya batterier. Ta alltid ur batterierna om produkten inte ska användas under en längre tid eller om batterierna är slut. Använd aldrig skadade batterier. Använd bara batterier av den typ som rekommenderas, eller av en motsvarande typ. Sätt i batterierna så att polerna hamnar i rätt läge. Laddningsbara batterier måste laddas med rätt slags batteriladdare och under en vuxens överinseende. Du kan inte ladda batterierna medan de fortfarande sitter i produkten, och du får heller aldrig försöka göra det. Försök aldrig ladda icke laddningsbara batterier. Kortslut aldrig batteriutrymmets kontaktkyter.

PT

Informação importante sobre as pilhas

Nunca use diferentes tipos de pilhas em simultâneo, ou uma combinação de pilhas usadas e novas. Retire sempre as pilhas se o produto não for usado durante muito tempo ou se as pilhas já não tiverem carga. Nunca use pilhas danificadas. Use apenas pilhas do tipo recomendado ou de um tipo correspondente. Insira as pilhas de forma a que os pólos fiquem corretamente posicionados. As pilhas recarregáveis devem ser recarregadas com o carregador de pilhas correto e sob a supervisão de um adulto. Não pode recarregar as pilhas enquanto as mesmas se encontram colocadas no produto e nunca deve tentar fazê-lo. Nunca tente recarregar pilhas não recarregáveis. Nunca deixe o compartimento das pilhas entrar em curto-circuito.

EL

Σημαντικές πληροφορίες για τις μπαταρίες

Μην χρησιμοποιείτε ποτέ διαφορετικούς τύπους μπαταριών μαζί και μην συνδυάζετε παλιές και καινούριες μπαταρίες. Αφαιρείτε πάντα τις μπαταρίες αν δεν σκοπεύετε να χρησιμοποιήσετε το προϊόν για αρκετό καιρό ή αν οι μπαταρίες έχουν αδειάσει. Ποτέ μην χρησιμοποιείτε μπαταρίες που έχουν σφραγιστεί. Χρησιμοποιείτε μόνο μπαταρίες του συνιστώμενου τύπου ή κίτσιου αντιστοίχου τύπου. Τοποθετήστε τις μπαταρίες με τους πόλους στη σωστή θέση. Οι επαναφορτιζόμενες μπαταρίες πρέπει να επαναφορτίζονται χρησιμοποιώντας το σωστό φορτιστή μπαταριών υπό την επίβλεψη ενήλικου. Δεν μπορείτε να επαναφορτίσετε τις μπαταρίες όταν αυτές βρίσκονται μέσα στο προϊόν και δεν πρέπει ποτέ να δοκιμάσετε κάτι τέτοιο. Μην επιχειρήσετε ποτέ να επαναφορτίσετε μη επαναφορτιζόμενες μπαταρίες. Ποτέ μην βραχυκυκλώσετε τη θήκη των μπαταριών.

JA

電池取扱いに関する重要事項

異なるタイプの電池や古い電池を混ぜて使用しないでください。商品を長時間使用しないときや電池が切れたときは、電池を必ず取り外してください。不具合のある電池は、絶対に使用しないでください。推奨されているタイプまたは対応しているタイプの電池を必ず使用してください。電線を確認して電池を正しい向きに入れてください。充電式電池は、保護者に見てもらった上で適切な充電器を使って充電してください。電池を商品の中に入れてそのまま充電することは絶対に避けてください。充電式ではない電池は絶対に充電しないでください。電池ホルダをショートさせないでください。

ZH

关于电池的重要信息

请勿同时使用不同类型的电池，或把新旧程度不同的电池混合使用。如果产品将有很长时间不会使用，或者电池已经没电，请注意取出电池。切勿使用已破损的电池。务必仅使用推荐类型或兼容类型的电池。装入电池时请注意正负极。如果使用充电电池，务必在成人监护下使用正确的电池充电器进行充电。电池仍在产品中时不可进行充电，请勿强行尝试充电。请勿尝试给非充电电池充电。切勿对电池仓进行短路连接。

KO

배터리 사용 시 주의사항

다른 종류의 배터리를 함께 사용하거나, 새 전지와 오래된 전지를 혼용하지 마세요. 배터리가 방전되었거나 장기간 제품을 작동하지 않을 때에는 반드시 배터리를 분리하세요. 파손된 배터리는 사용하지 마세요. 레고에서 권장하는 유형의 배터리만 사용하세요. 양극과 음극의 위치를 잘 맞춰서 넣으세요. 어른의 감독에 따라 지정된 충전기에 충전지를 충전해야 합니다. 충전지를 제품에 넣은 상태로 충전하면 안 됩니다. 일만 배터리는 충전해서 사용하지 않습니다. 배터리 홀더의 접촉부에 배터리를 정확히 끼워서 사용하세요.

RU

Необходимая информация об элементах питания

Ни в коем случае не используйте одновременно элементы питания различных типов, а также элементы питания с разным сроком годности. В обязательном порядке внимайте элементы питания из терминалов в случае, если вы не пользуетесь прибором в течение долгого времени, либо в случае, если в элементах питания закончился заряд. Если в коем случае не используйте поврежденные элементы питания. Используйте только рекомендуемые элементы питания либо элементы питания соответствующего типа. Установите элементы питания, соблюдая указанную полярность. Аккумуляторные элементы питания должны подзаряжаться в соответствующем зарядном устройстве под наблюдением взрослого. Ни в коем случае не пытайтесь подзаряжать элементы питания, находящиеся в приборе. Ни в коем случае не пытайтесь подзаряжать перезаряжаемые элементы питания. Ни в коем случае не пытайтесь замкнуть полюса в устройстве для элементов питания.



EN	Protect the environment by not disposing of this product with your household waste (2002/96/EC). Check with your local authority for recycling advice and facilities.	EL	Προστατέψτε το περιβάλλον. Μην πετάτε αυτό το προϊόν μαζί με τα συνηθισμένα οικιακά απορρίμματα (2002/96/EC). Επικοινωνήστε με τις τοπικές αρχές σχετικά με συμβουλές και εγκαταστάσεις ανακύκλωσης.	HR	Zaštitite okoliš tako da ovaj proizvod ne odložite u otpad zajedno s kućanskim otpadom (2002/96/EZ). Od lokalnih vlasti zatražite savjet ili informacije o pogonima za recikliranje.
DE	Schützen Sie die Umwelt und entsorgen Sie dieses Produkt nicht mit Ihrem Hausmüll (2002/96/EC). Informationen zu Recycling-Möglichkeiten erhalten Sie bei den örtlichen Behörden.	JA	環境保護のため、本製品は家庭ごみとは別に処分してください(2002/96/EC)。リサイクルに関する指示や施設については、お住まいの地方自治体にお問い合わせください。	SR	Zaštitite životnu sredinu tako što nećete odlagati ovaj proizvod sa kućnim otpadom (2002/96/EC). Obratite se lokalnoj ovlašćenoj službi da biste dobili savete o recikliranju i saznali o objektima za reciklažu.
FR	Protégez l'environnement : ne jetez pas ce produit avec vos autres déchets ménagers (Directive européenne 2002/96/EC). Contactez les autorités locales pour obtenir des informations sur le recyclage et connaître les points de collecte.	ZH	注意保护环境，请勿将本产品与家庭垃圾一起丢弃处理(2002/96/EC)。请咨询您当地相关部门，了解回收设施与回收建议。	SL	Zaščitite okolje! Okolje varujte tako, da tega izdelka ne zavržete skupaj z gospodinjiskimi odpadki (v skladu z direktivo 2002/96/ES). Pri krajevni upravi preverite, kakšne možnosti in kateri obrati za recikliranje obstajajo v vaši okolici.
IT	Proteggi l'ambiente! Non smaltire questo prodotto con i rifiuti domestici (2002/96/EC). Per consulenza sul riciclaggio dei rifiuti e le strutture di riciclaggio, rivolgersi alle proprie autorità locali.	KO	환경 보호를 위해 이 제품을 생활폐기물과 함께 버리지 마십시오(2002/96/EC). 재활용 방법 및 시설에 관한 사항은 현지 관계 당국에 문의하십시오.	RO	Protejați mediul înconjurător și nu vă debarașați de acest produs împreună cu deșeurile menajere (2002/96/CE). Consultați autoritățile locale pentru îndrumări și facilități de reciclare.
NL	Bescherm het milieu: gooi dit product niet samen met het andere huisvuil weg (2002/96/EC). Raadpleeg de plaatselijke instanties voor locaties van milieustations en advies over hergebruik.	PL	Aby chronić środowisko naturalne, nie należy wyrzucać tego produktu wraz z odpadkami z gospodarstwa domowego (2002/96/WE). W celu uzyskania wskazówek dotyczących recyklingu oraz adresów zakładów należy skontaktować się z lokalnym urzędem.	BG	Защитете околната среда и не изхвърляйте този продукт заедно с битовите си отпадъци (2002/96/EO). Свържете се с местните власти относно съвети и съоръжения за рециклиране.
ES	Proteja el medio ambiente no deshaciéndose de este producto junto con sus residuos domésticos (2002/96/EC). Solicite a su autoridad local consejos e información sobre instalaciones de reciclado.	CZ	Nevyhazujte tento produkt do domácího odpadu, chraňte životní prostředí (2002/96/EC). Zjistěte si prosím u místních úřadů možnosti recyklace a dostupná zařízení.	LV	Lai saudzētu vidi, neizmetiet šo izstrādājumu kopā ar sadzīves atkritumiem (2002/96/EC). Vērsieties vietējās varas iestādēs, lai noskaidrotu, kur un kā tas nododams pārstrādei.
DA	Beskyt miljøet! Smid ikke dette produkt ud sammen med husholdningsaffaldet (2002/96/EF). Få vejledning om genbrug og genbrugsstationer hos din kommune.	SK	Nevyhádzajte tento produkt do domáceho odpadu, chráňte životné prostredie (2002/96/EC). Zistite si prosím na miestnych úradoch možnosti recyklácie a dostupné zariadenia.	ET	Keskkonda saate kaitsa nii, et ei kõrvalda seda toodet koos olmejäätmetega (2002/96/EÜ). Nõuandeid toote taaskasutusse võtmise ja ümbertöötlemispunktide kohta saate asjaomaselt kohalikult asutuselt.
FI	Tämä tuote on hävitettävä ympäristönsuojelun vuoksi asianmukaisesti talousjätteistä erillään (2002/96/EC). Tietoja kierrätyspisteiden sijainnista saa kunnan tai kaupungin teknisestä virastosta.	HU	Környezetét óvja, ha ettől a terméktől nem a háztartási hulladékkal együtt válik meg (2002/96/EC). Érdeklődjék a lakóhelyéhez közel eső hatóságnál az újrahasznosítás módjáról és lehetőségeiről.	LT	Saugokite aplinką – nemeskite šio produkto kartu su buitinėmis atliekomis (2002/96/EB). Atsižvelkite į savo vietos valdžios rekomendacijas dėl pakartotinio panaudojimo ir sąlygas.
SV	Skydda miljön genom att inte kasta denna produkt bland ditt hushållsavfall (2002/96/EC). Kontakta din kommun för frågor om återvinning och miljöstationer.	UA	Допоможіть захистити довкілля: не утилізуйте цей виріб разом із побутовим сміттям (2002/96/EC). Вказівки з утилізації та відомості про пункти прийому з'ясуєте в місцевих компетентних органах.	TR	Bu ürünü, evsel atıklarla birlikte atmayarak çevreyi koruyun (2002/96/EC). Geri dönüşüm tavsiyeleri ve tesisler hakkında bilgi için yerel yönetimle iletişimi kurun.
PT	Proteja o ambiente não eliminando este produto com o seu lixo doméstico (2002/96/CE). Consulte as autoridades locais para informação sobre reciclagem e sistemas de recolha.			ID	Jagalah lingkungan dengan tidak membuang produk ini bersama sampah rumah tangga Anda (2002/96/EC). Periksa peraturan pemerintah setempat tentang saran dan fasilitas daur ulang.



Remote Control

Fernbedienung
Télécommande
Control remoto
Comando à distância
Távírányító
远程控制
Remote control



ON/OFF
An/Aus
Marche/arrêt

Encendido/apagado
Ligado/Desligado
Be/ki

开/关
Hidup/mati

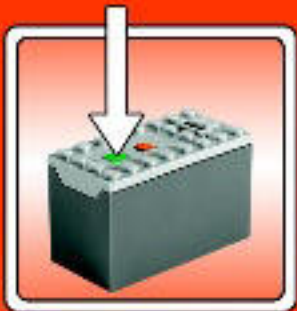

Battery Box

Batteriebox
Boîtier à piles
Batería
Bateria
Elemtartó doboz
电池盒
Kotak baterai





7 speeds • 7 Geschwindigkeiten • 7 vitesses
7 velocidades • 7 velocidades • 7 sebességfokozat • 7 速 • 7 kecepatan



7 speeds • 7 Geschwindigkeiten • 7 vitesses
7 velocidades • 7 velocidades • 7 sebességfokozat • 7 速 • 7 kecepatan

Change direction of train
Änderung der Fahrtrichtung
Change le sens de la marche du train
Cambia la direzione del treno
Verander de rijrichting van de trein
Cambia la dirección del tren
Skift togets retning
Junan kulkusuunnan vaihtaminen
Ändra tågets riktning
Mudar a direcção do comboio
Αλλάξε την κατεύθυνση του τρένου
トレインの進行方向を変える
改变列车方向
회전 방향 바꾸기
Изменение направления движения поезда
Zmień kierunek jazdy pociągu
Změna směru vlaku
Zmena smeru vlaku
A menetirány átváltása
Переключатель направления поезда
Promjena smjera vlaka
Промени смер воза
Spremeni smer voznje vlaka
Schimba direcția trenului
Променете посоката на движение на влака
Maini vilciēna kustības virzienu
Rongji soidusuuna muutmise
Pakeisk traukinio krypti
Tren yönünü deęiřtirin
Ubah arah kereta

Turn wheel and change speed
Einstellung der Fahrtgeschwindigkeit
Tourne le volant et change de vitesse
Gira la rotellina e cambia velocita
Draai het wiel voor meer of minder snelheid
Gira la rueda para cambiar la velocidad del tren
Drej hjulet, og skift hastighed
Nopeuden sato kantopyralla
Vrid pa ratten och ndra hastighet
Rodar o boto para alterar a velocidade
Γυρίσε τον τροχ και λλαξε ταχύτητα
車輪を回転させる / スピードを変える
转向与改变速度
바퀴를 돌려 속도 바꾸기
Поверните колесико, чтобы изменить скорость
Obroć koo, by zmieni predkość
Oto koleckem a zme rychlost
Oto kolieskom a zme rychlost
A kerek elforgatasaval a sebesseg valtozik
Obertannya kolesa zmnoyesya shvidkość
Brzina se roeđava okretanjem kotasica
Okreni tocki da promeniš brziny
Zavrti koleřek in spremeni hitrost
Roeřte roata ři schimba viteza
Zavrteťte koeloto, za da promenite skorostta
Pogriez ripu un maini trumu
Keera rooli ja muuda kiirust
Pasuk ratuka ir pakeisk greiť
Tekeri evirip hizi deęiřtirin
Putar tombol untuk mengubah kecepatan



Train trouble-shooting guide
Anleitung zur Fehlerbehebung bei Zügen
Guide de depannage du train
Gua de soluio de problemas ferroviarios
Gua de resoluo de problemas do comboio
列车故障指南

LEGO.com/city



Remote Control

Fernbedienung
Télécommande
Control remoto
Comando à distância
Távirányító
远程控制
Remote control



Receiver

Empfänger
Récepteur
Receptor
Receptor
Vevő
接收器
Receiver

8 Channels Frequenzen canaux
canales canals csatorna 频道 Kanal





1x



+

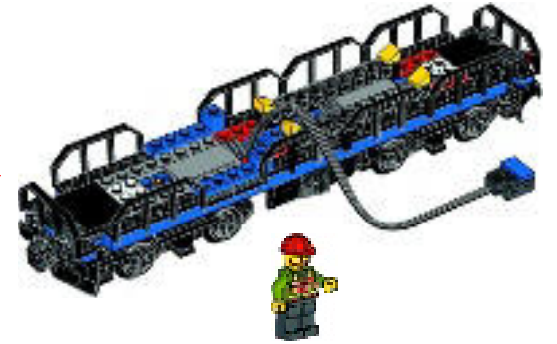

1x

2x



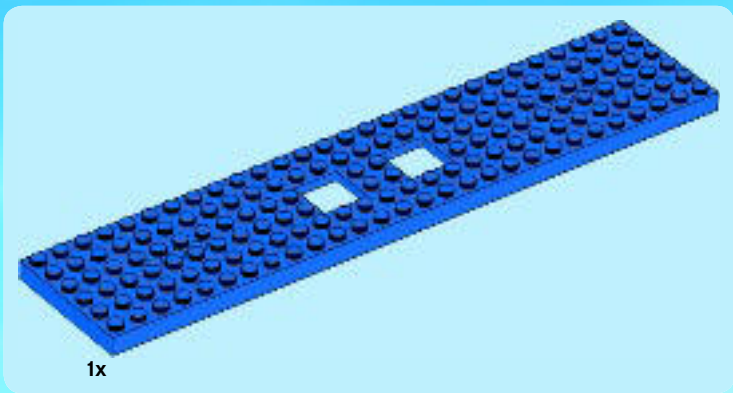

1

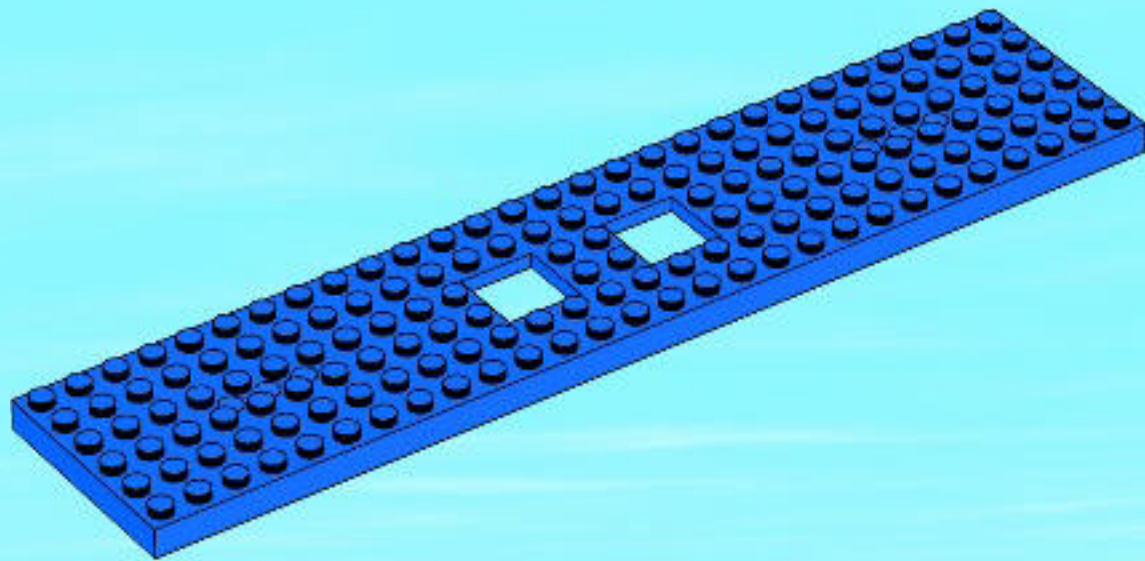



2x



2x

2

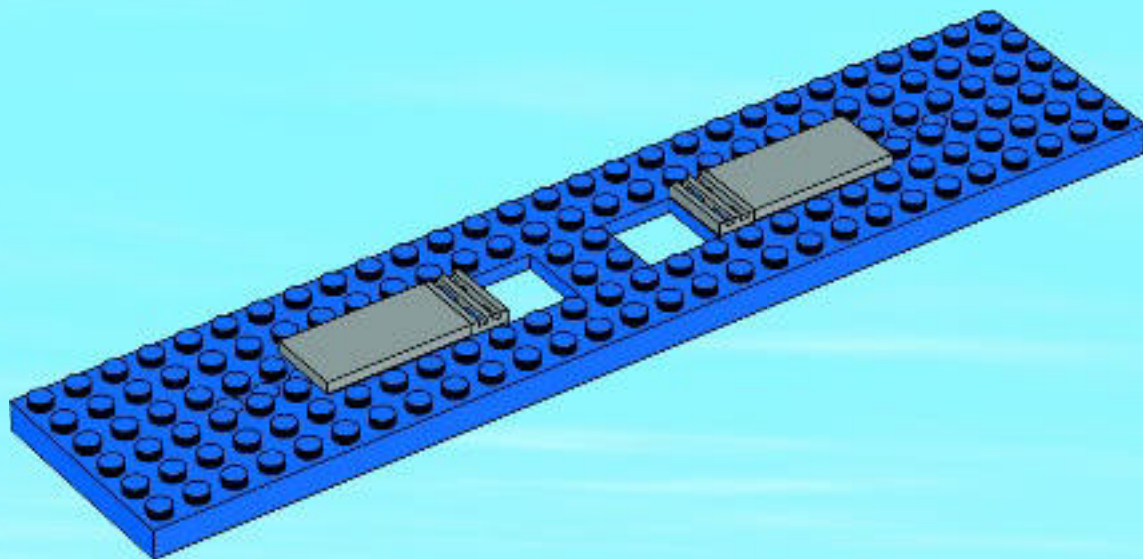

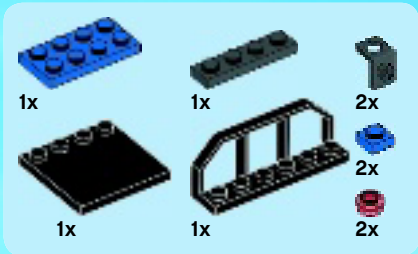

3

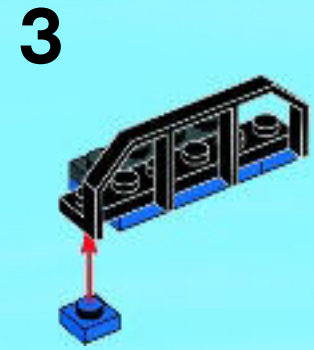
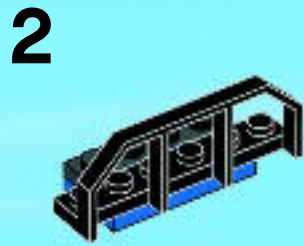
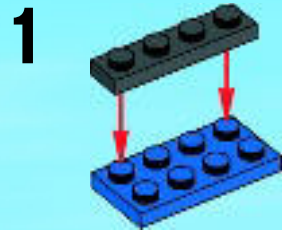

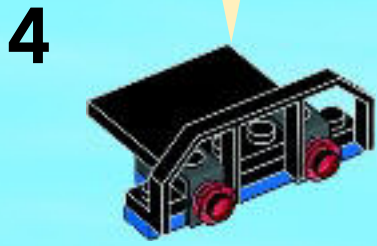

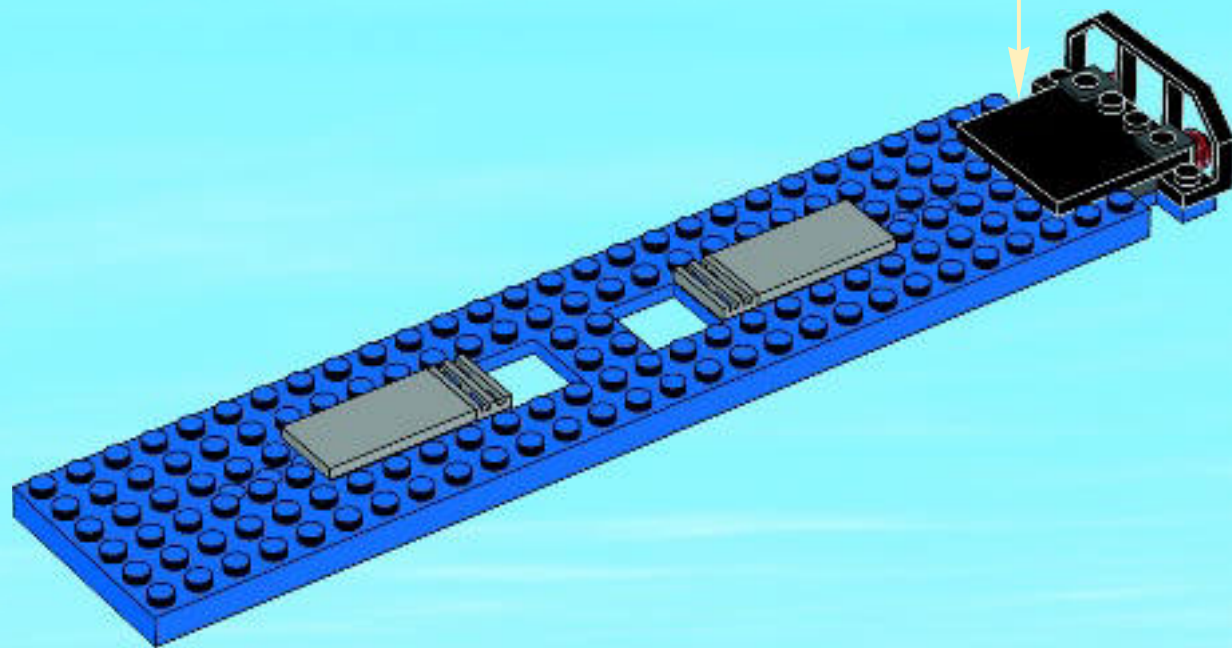



1x



2x

4

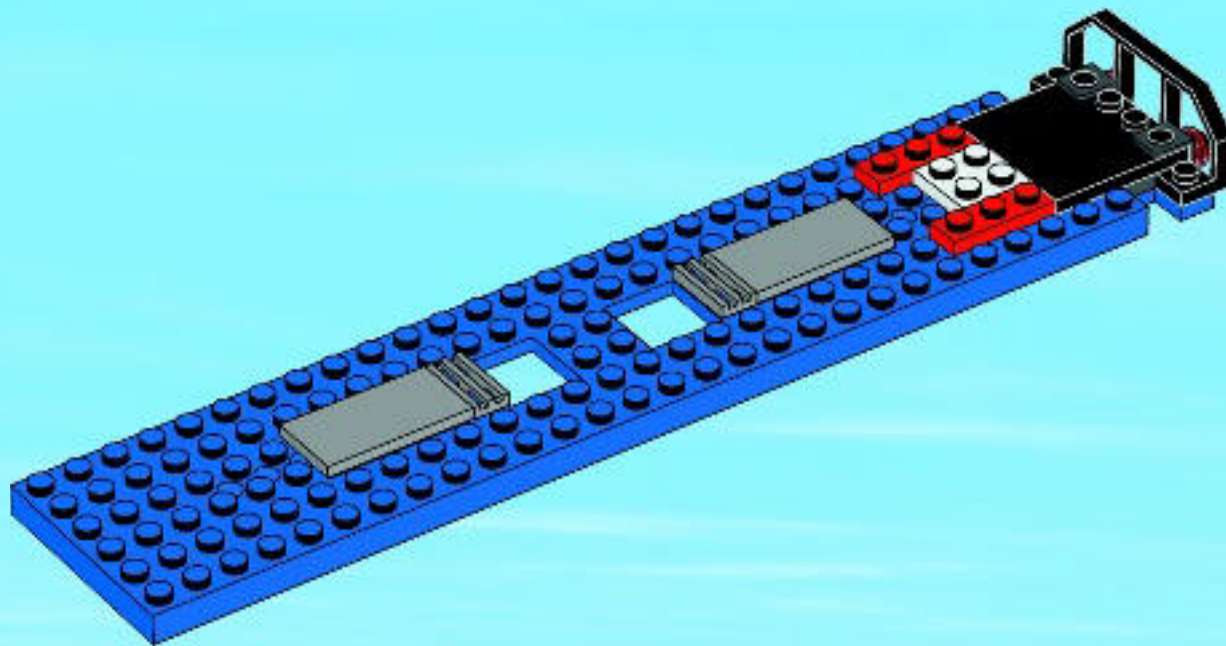



5

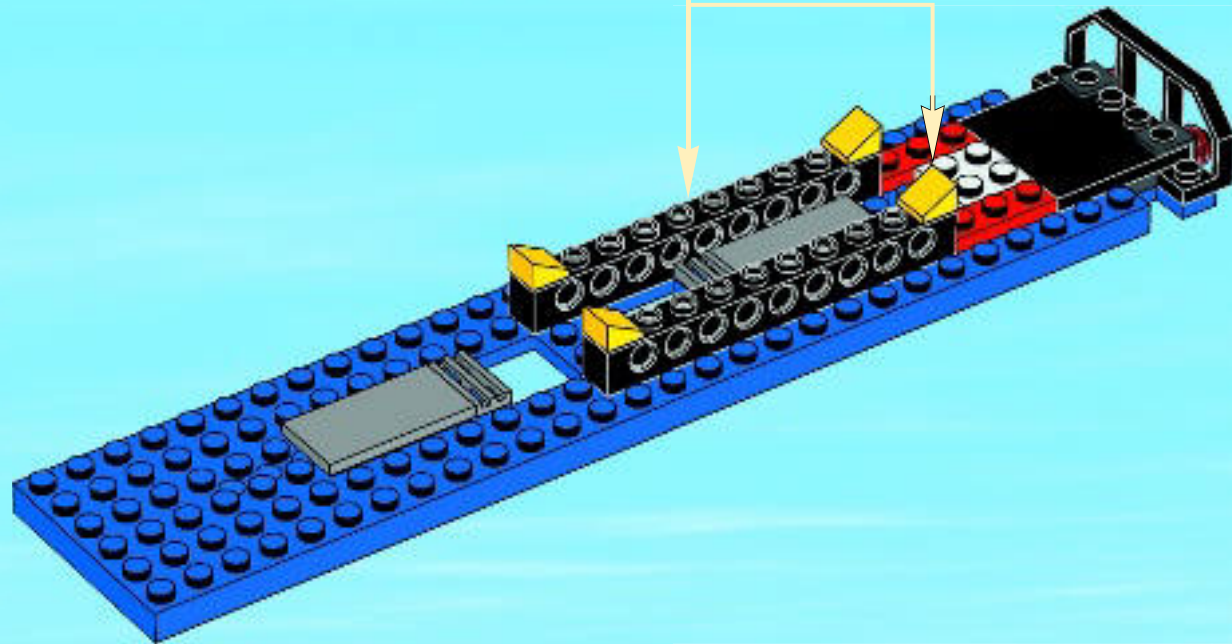
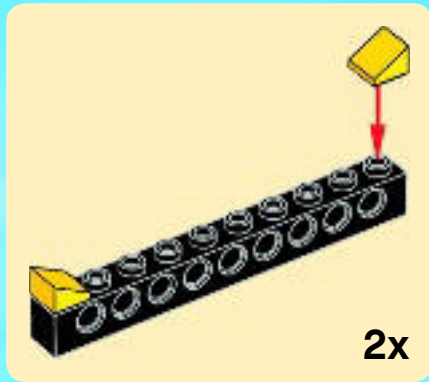



2x

6

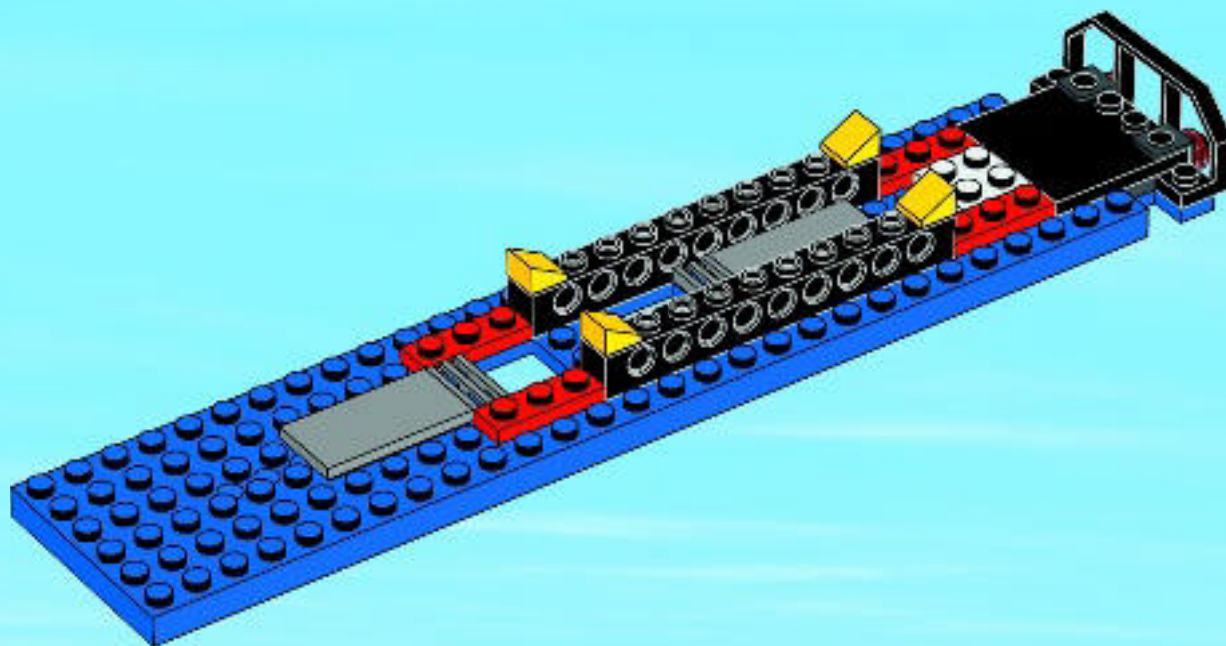

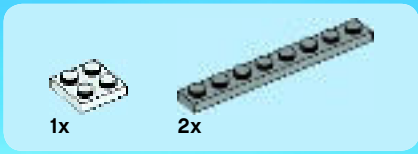

7

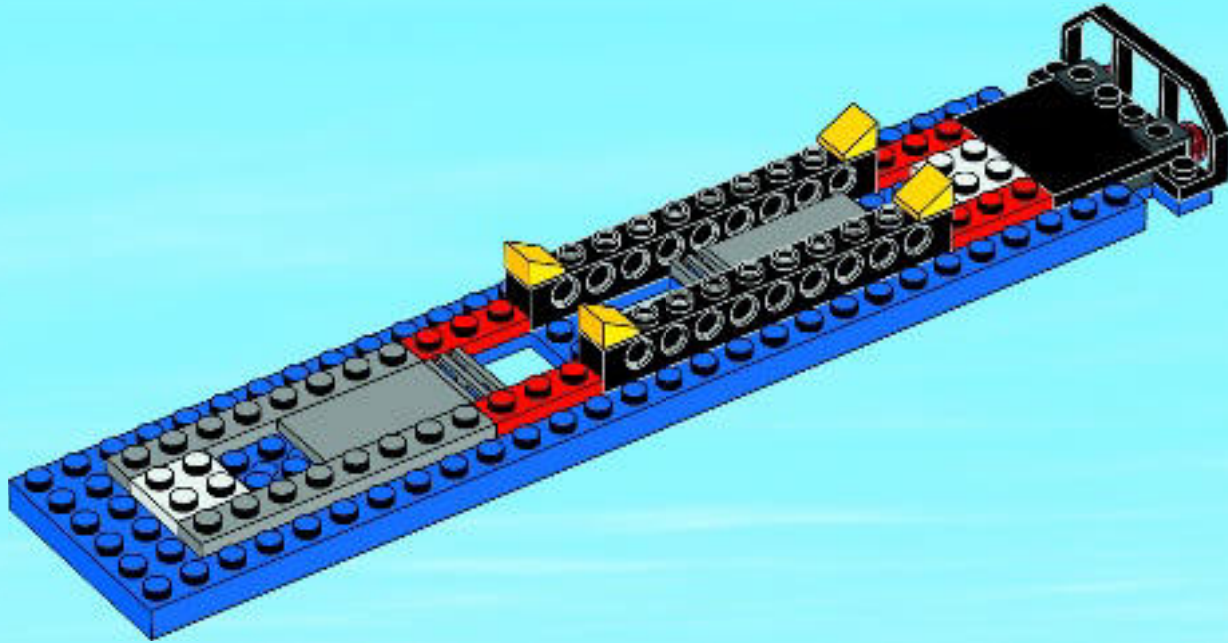

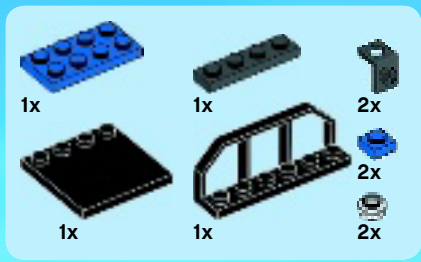

8

1

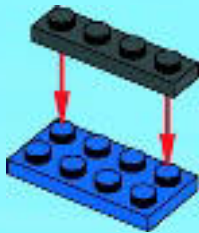

2



3

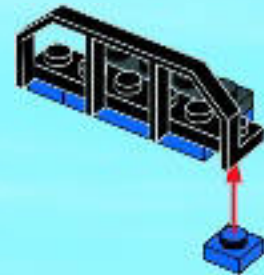



4

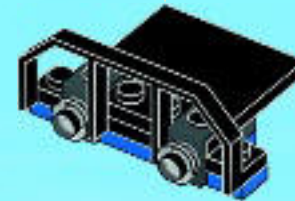

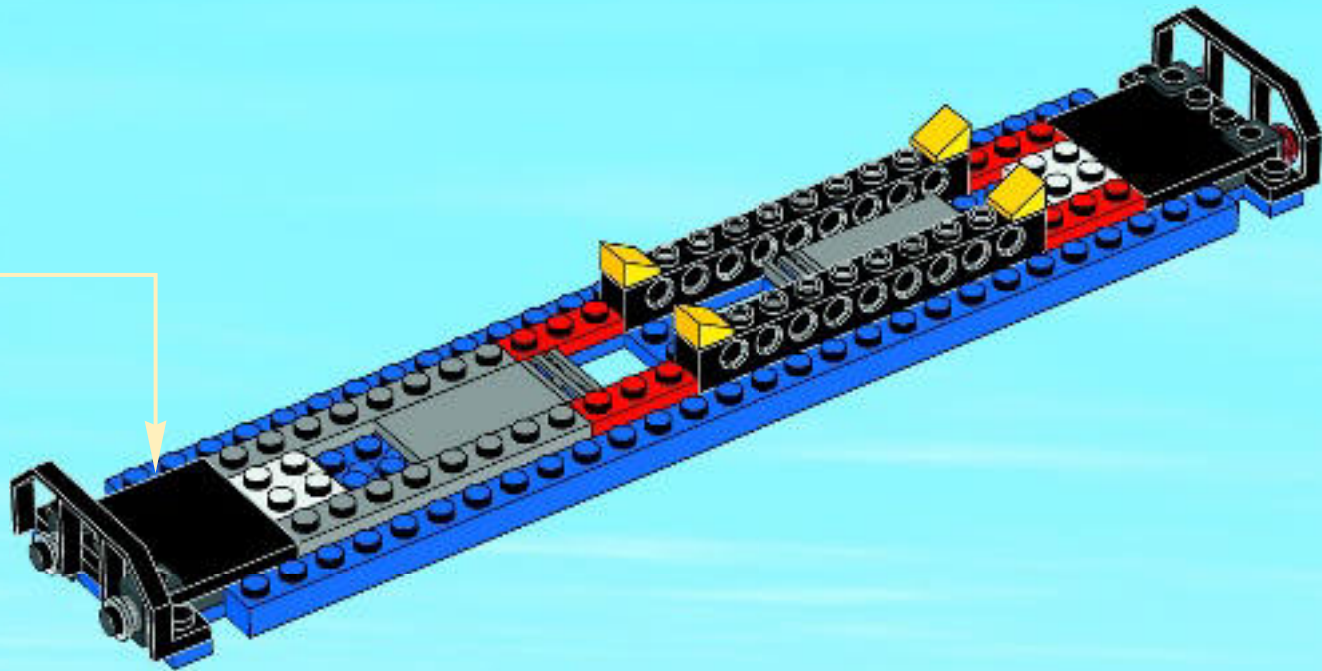



6x

9

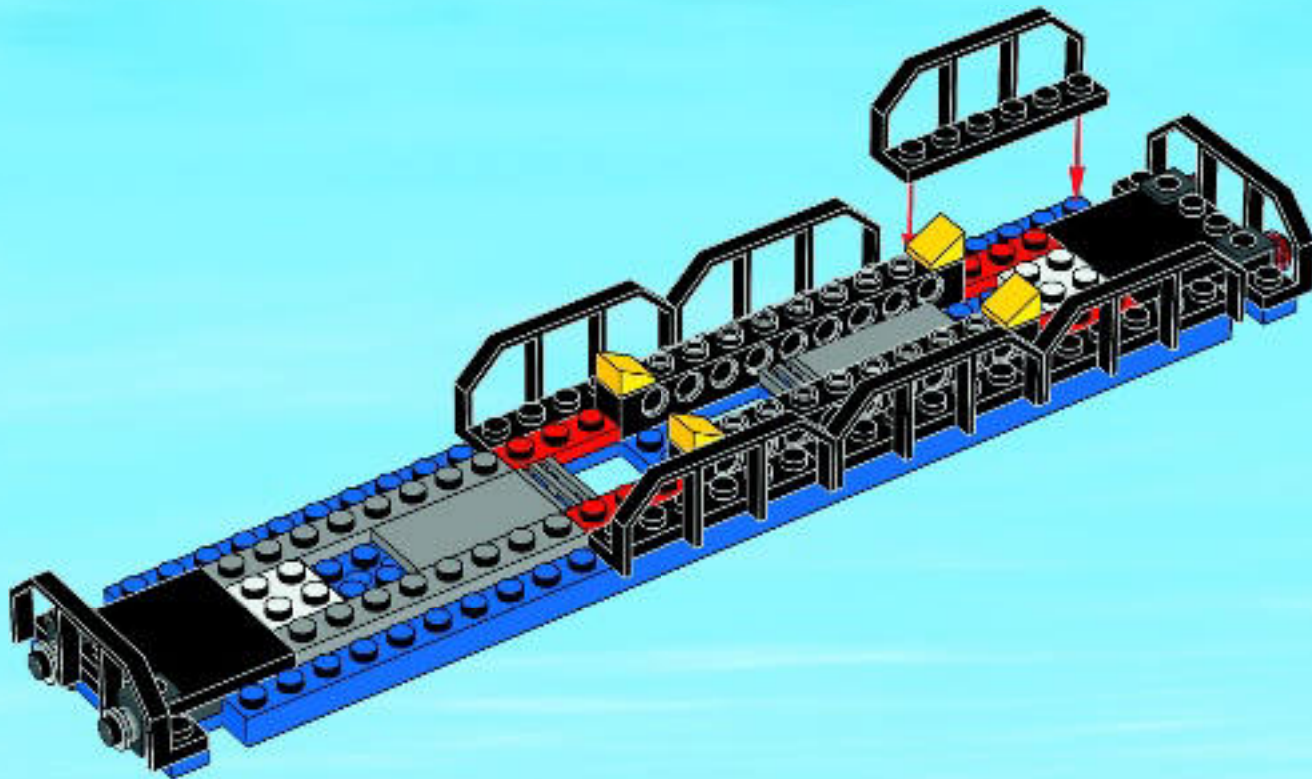



2x

10

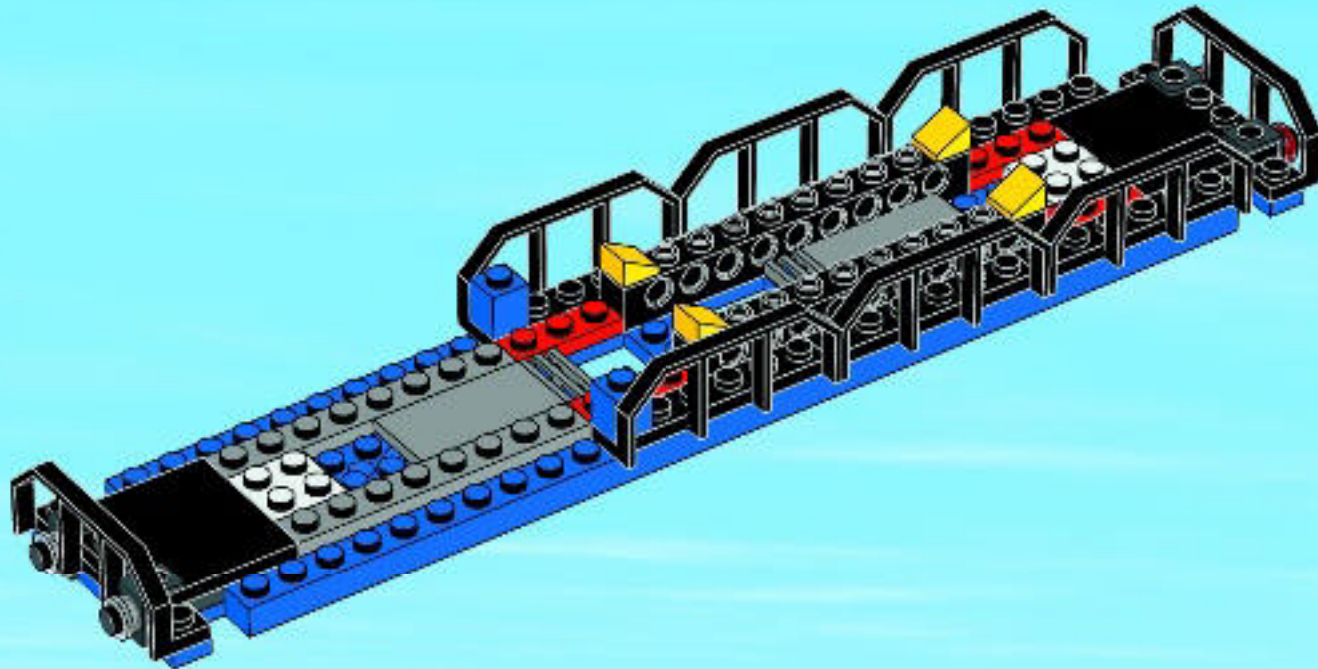



2x



4x

11

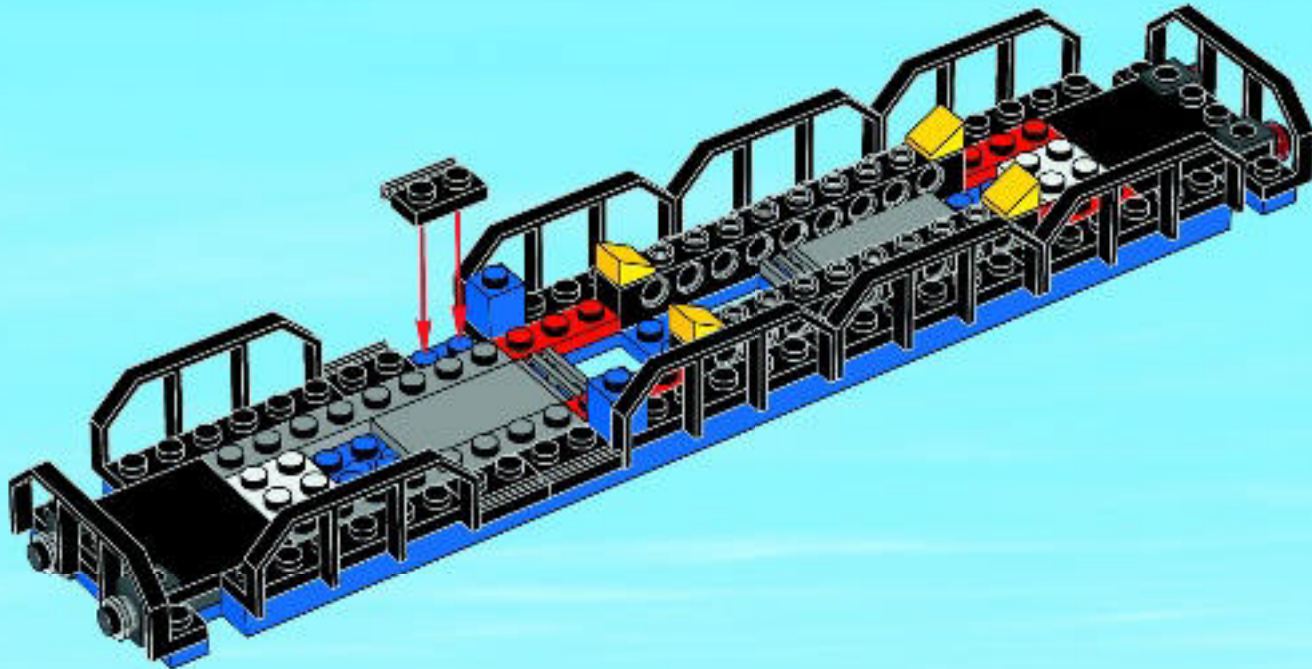



2x

12

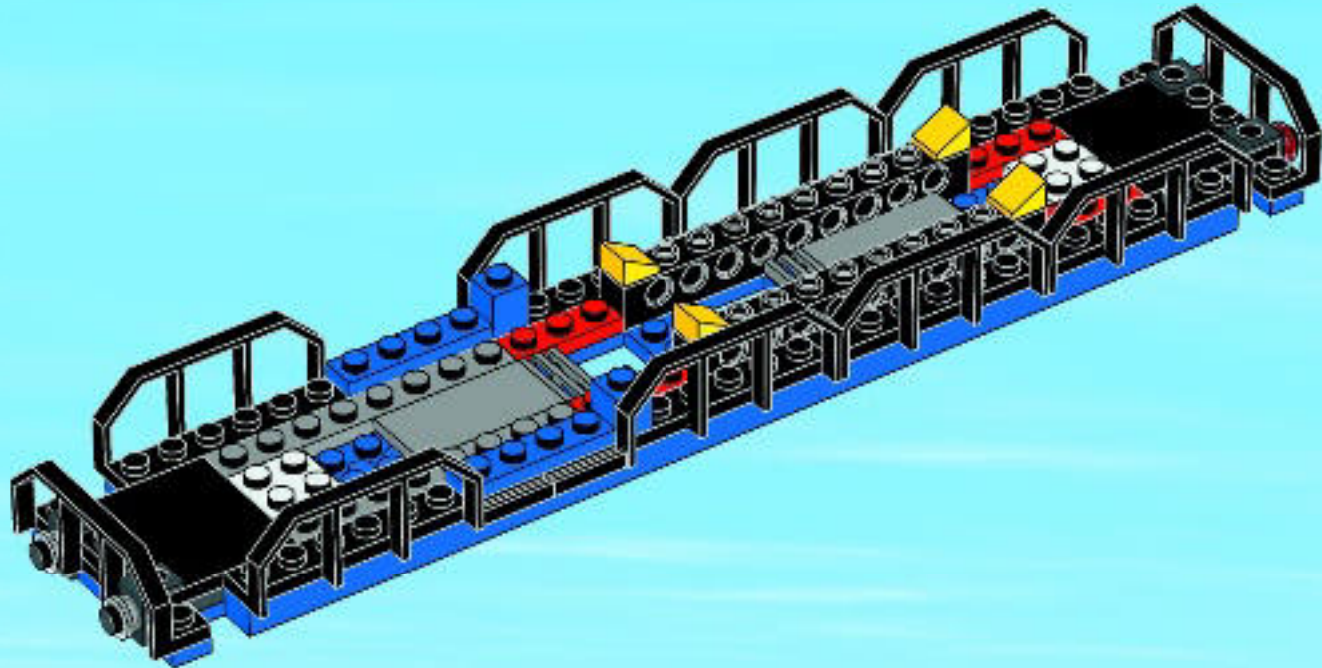



1

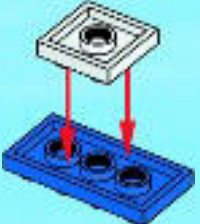

2

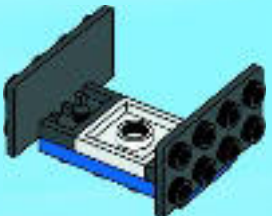

3

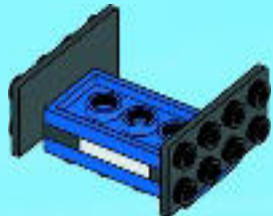



4

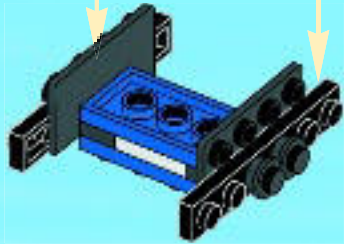
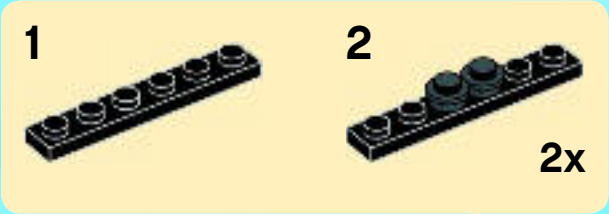

5

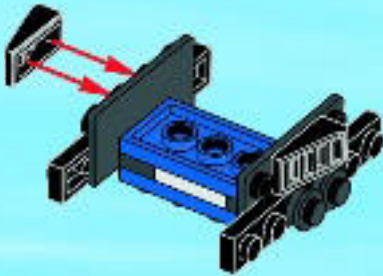



2x

6

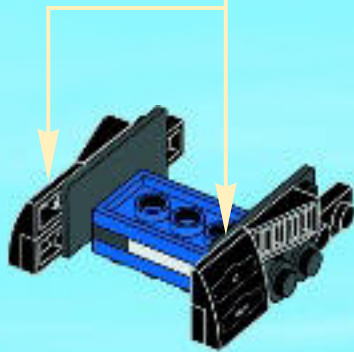
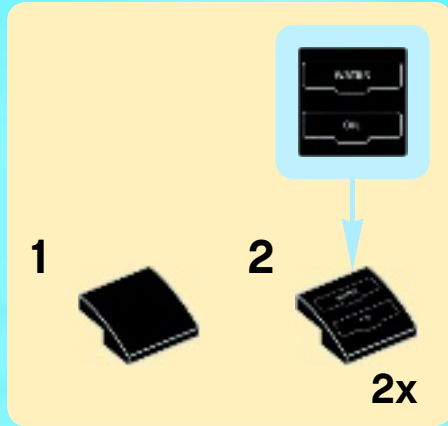

2x

7

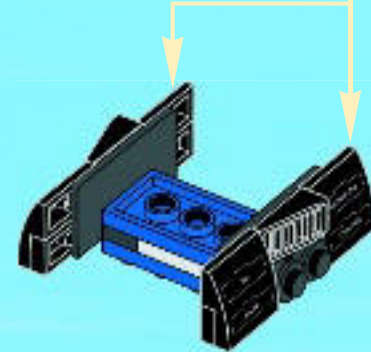
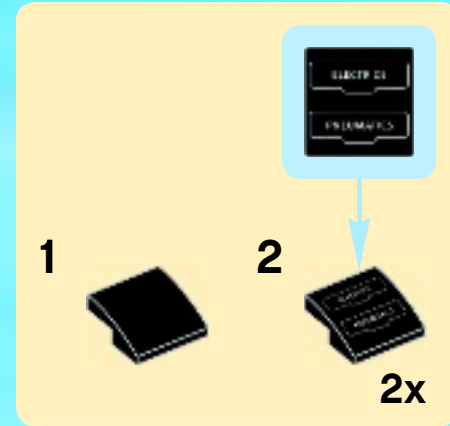

13

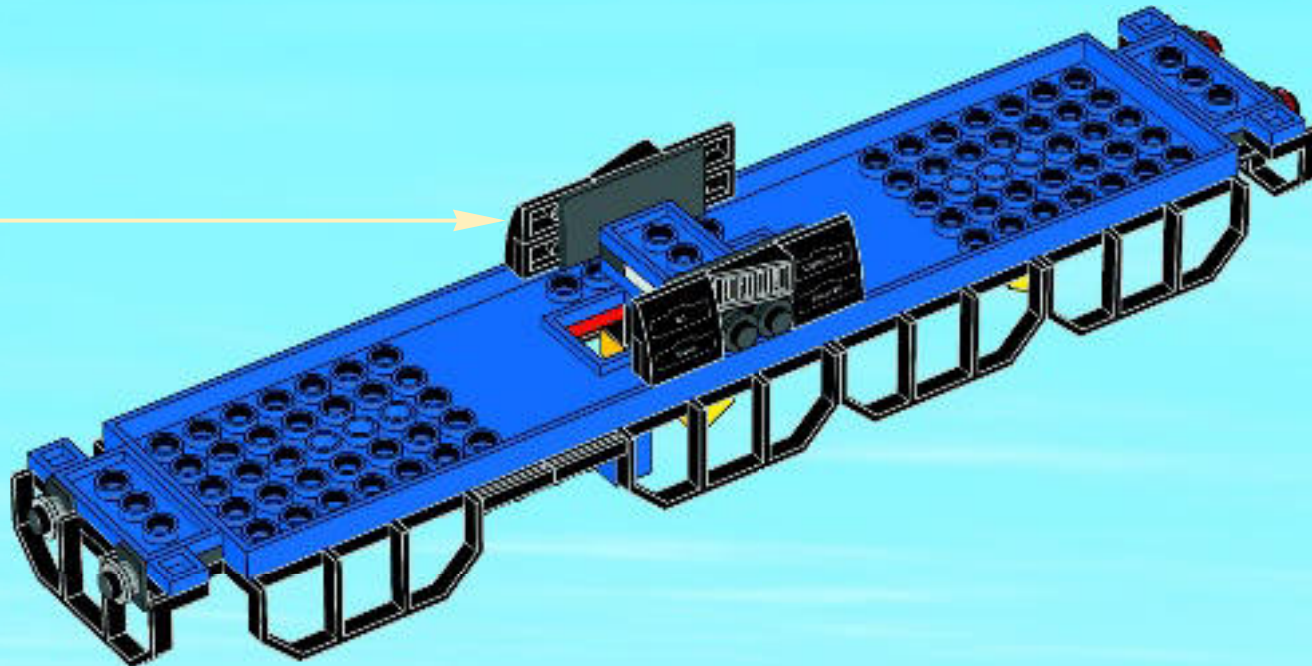



1



2

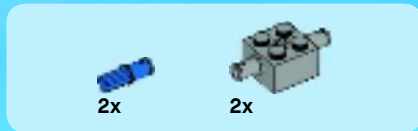

3

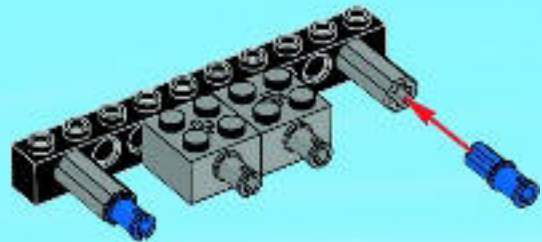



4

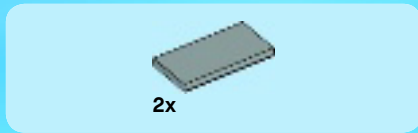

5

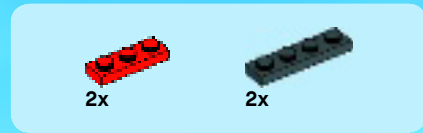
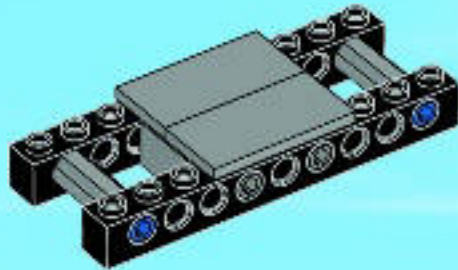

6

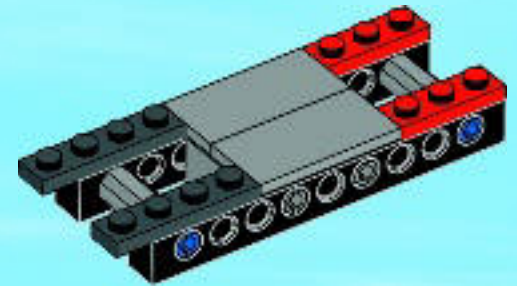



7



8

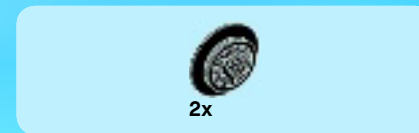
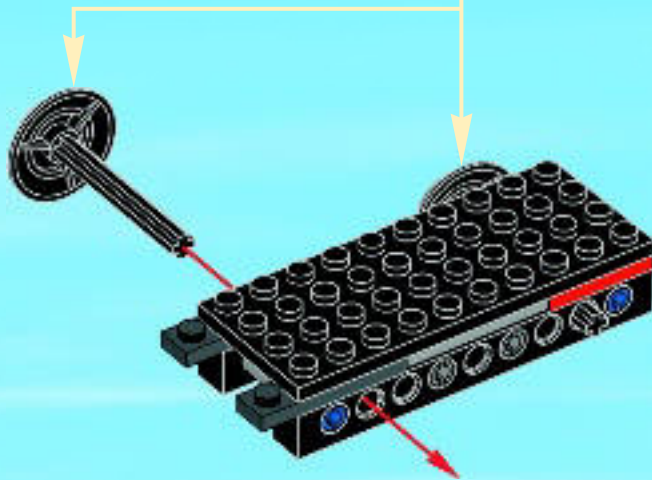
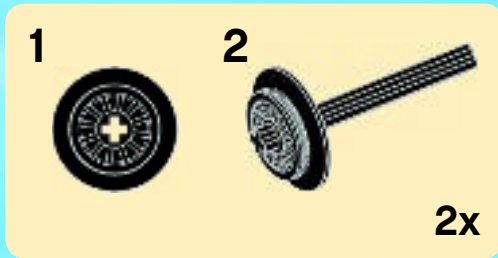

9



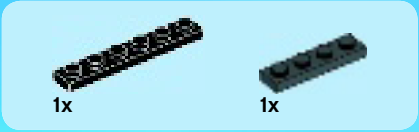

10

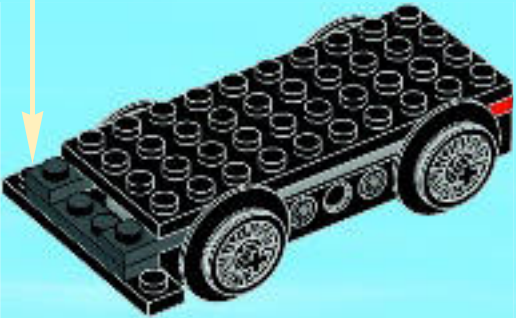
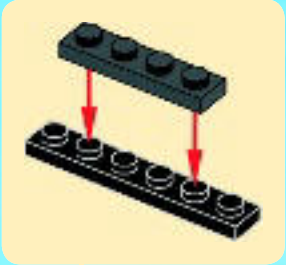

11

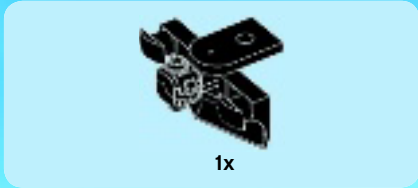
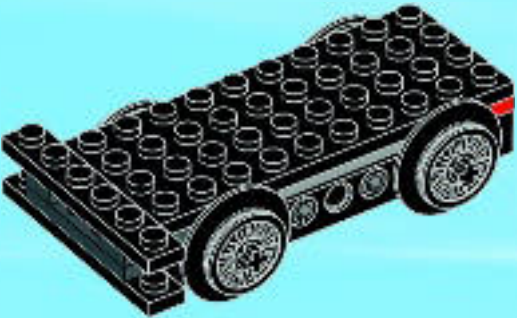

12

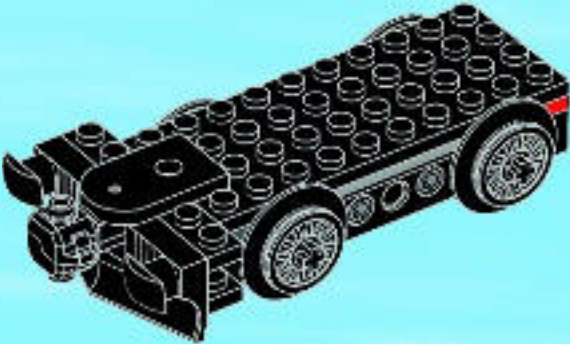

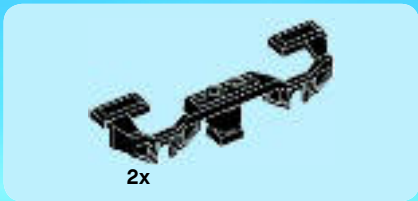

13

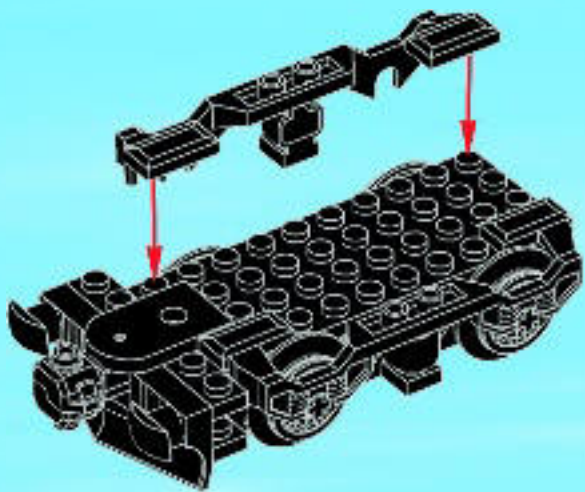

14

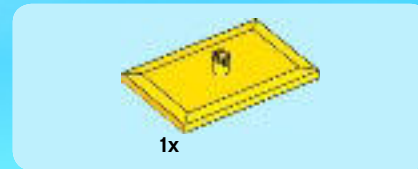
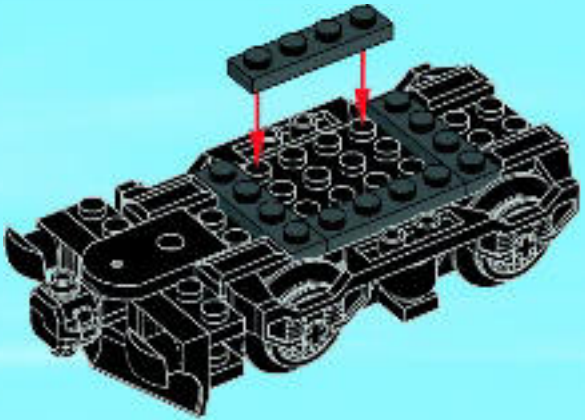

15

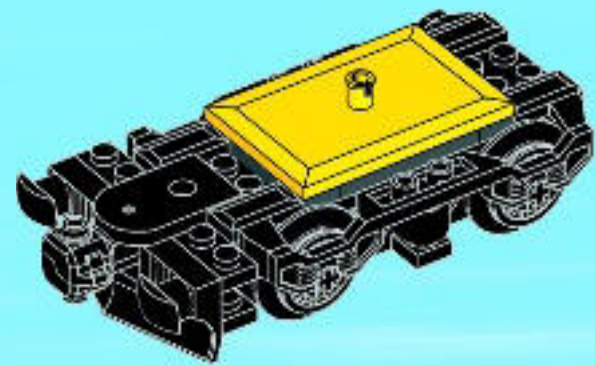

14

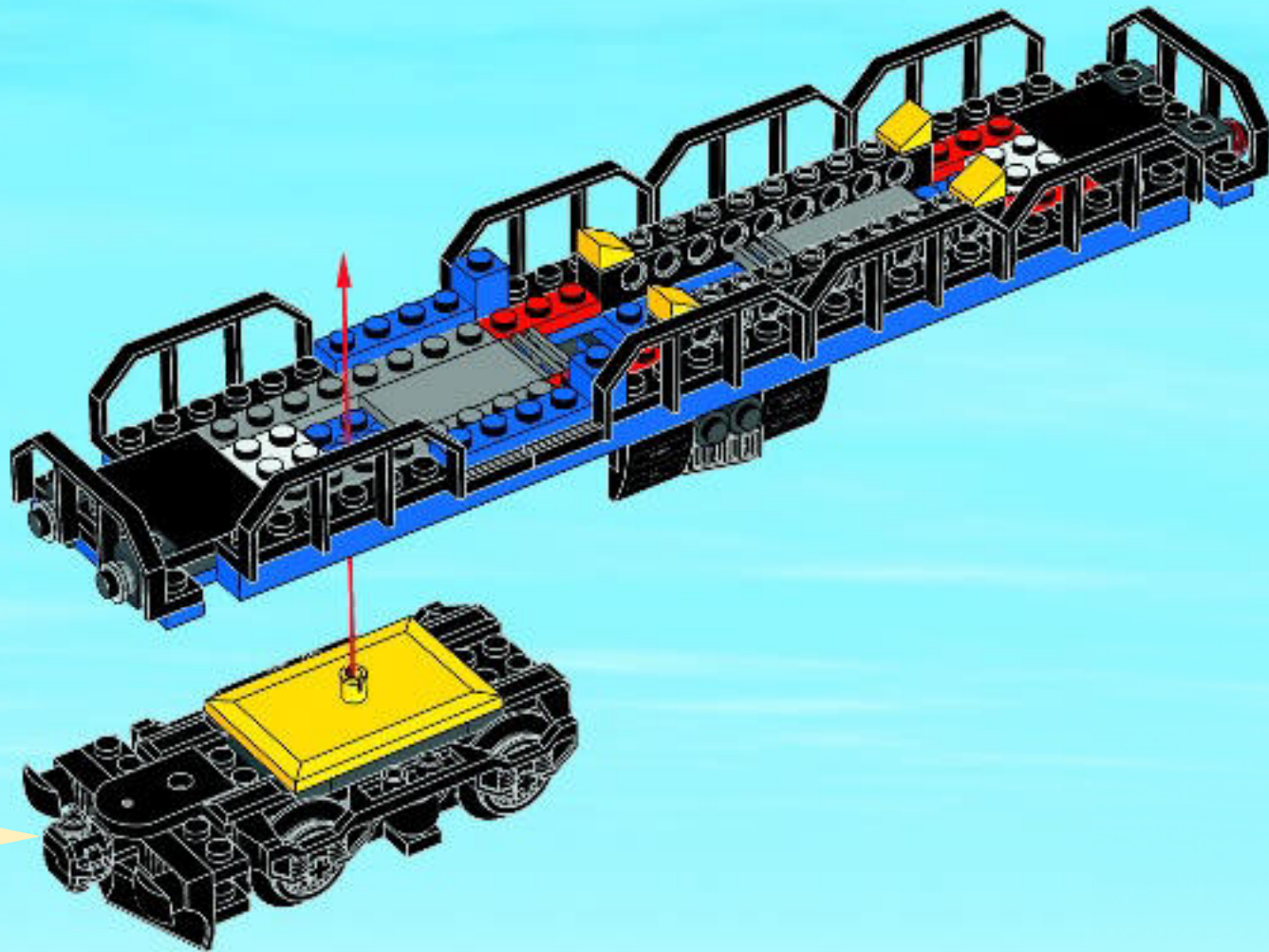

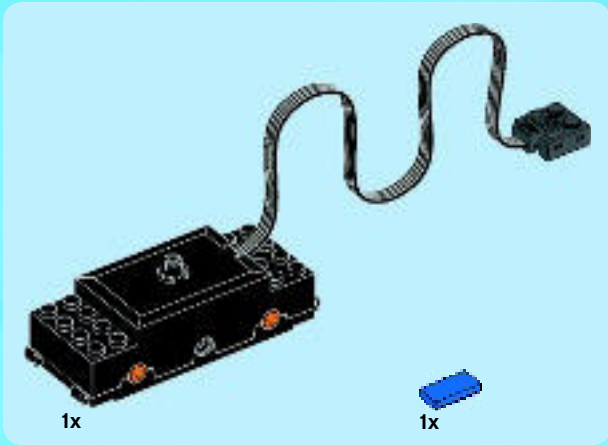

1

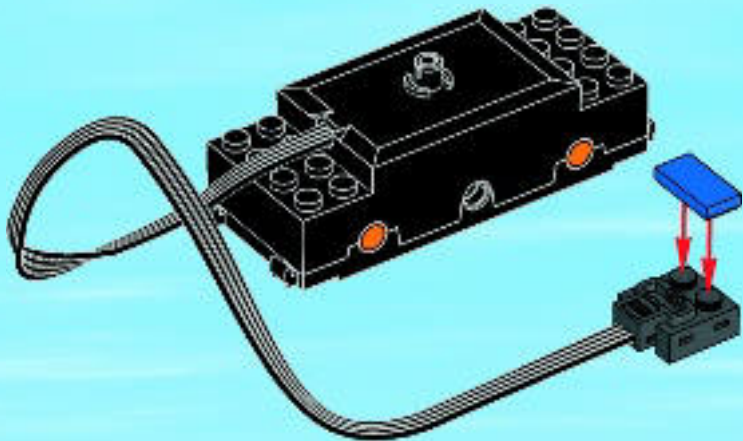

2

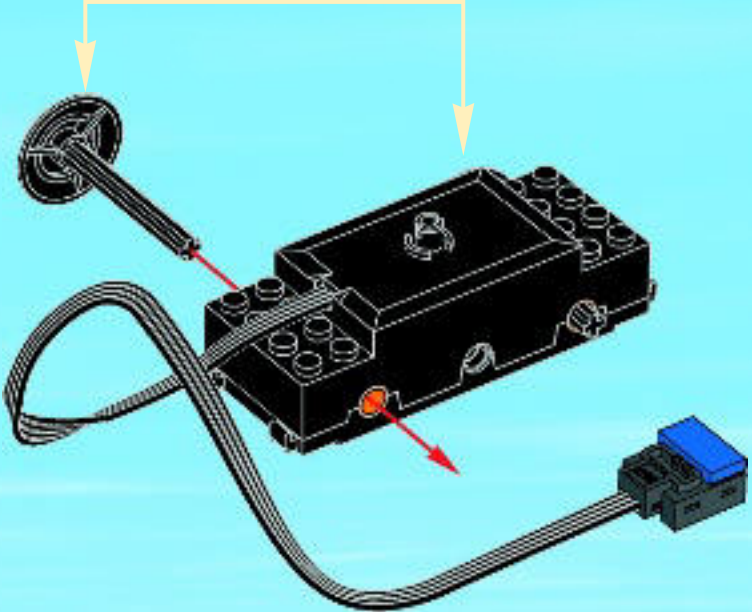
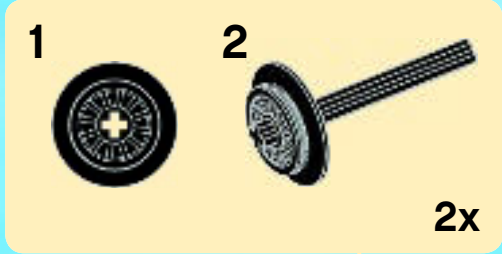



2x

3

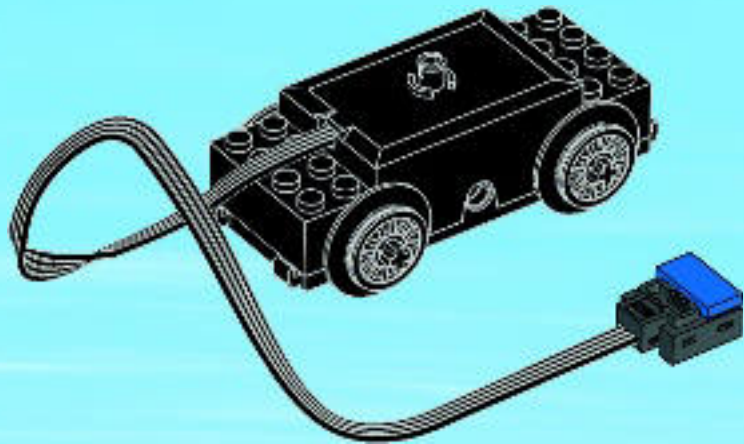

2x



2x

4

1



2

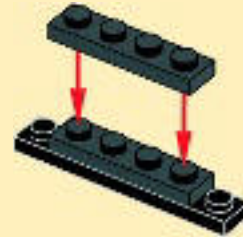

3

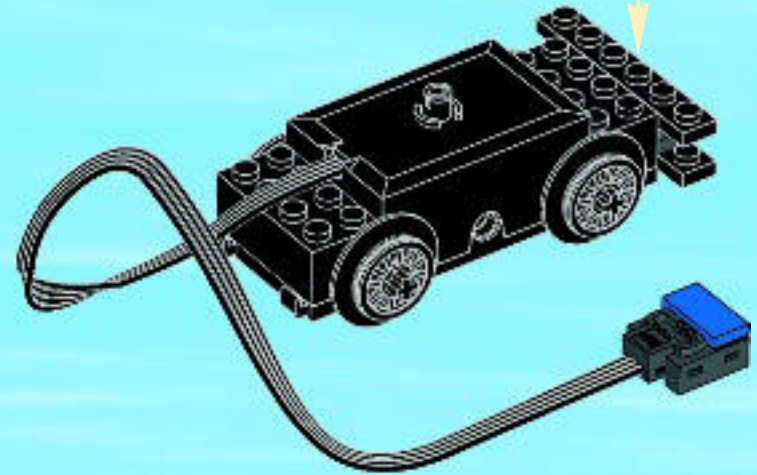
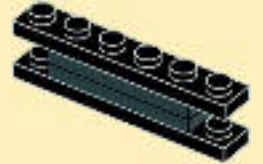



5

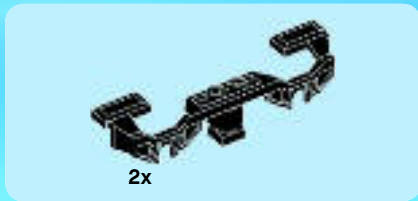
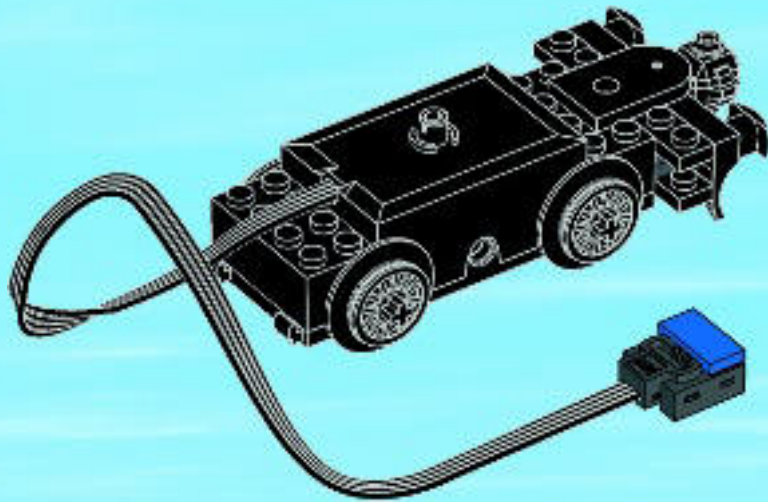

6

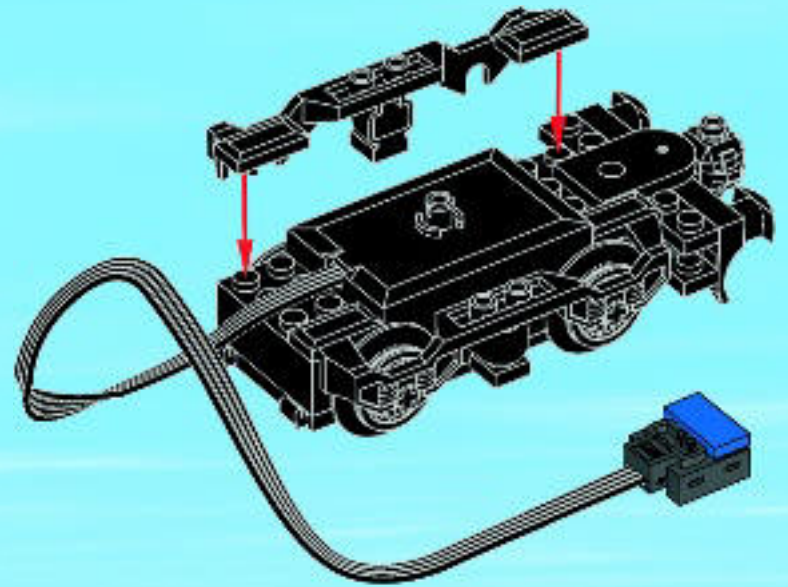

15

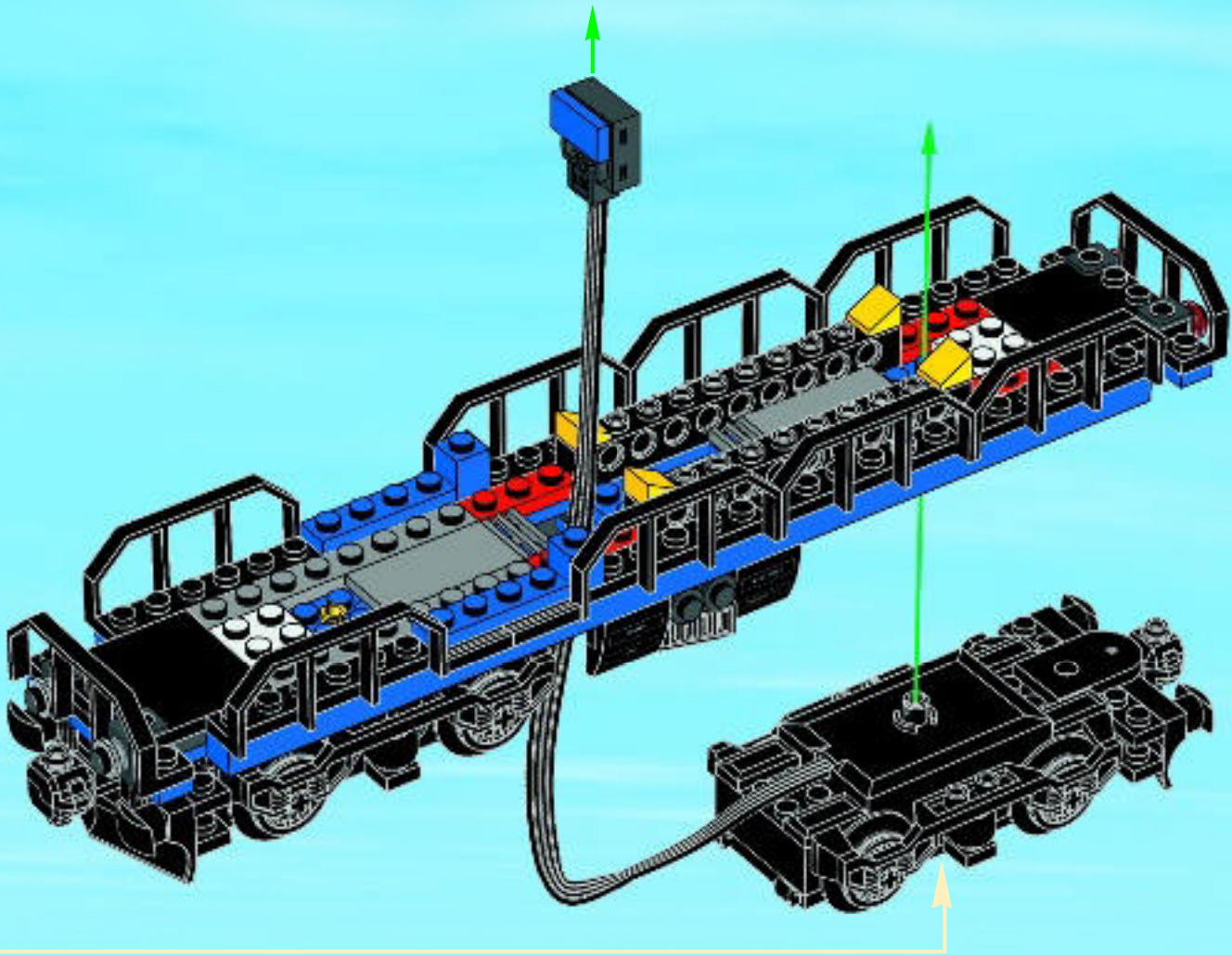

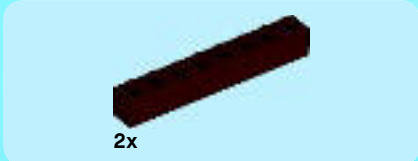
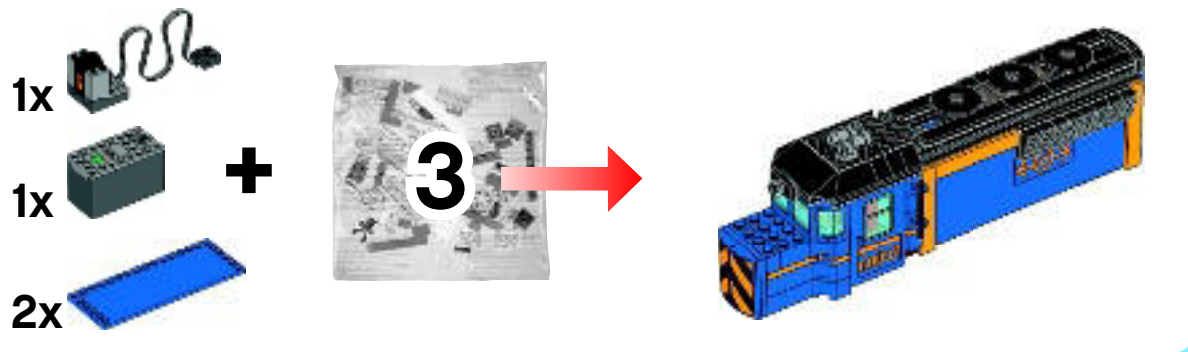

16

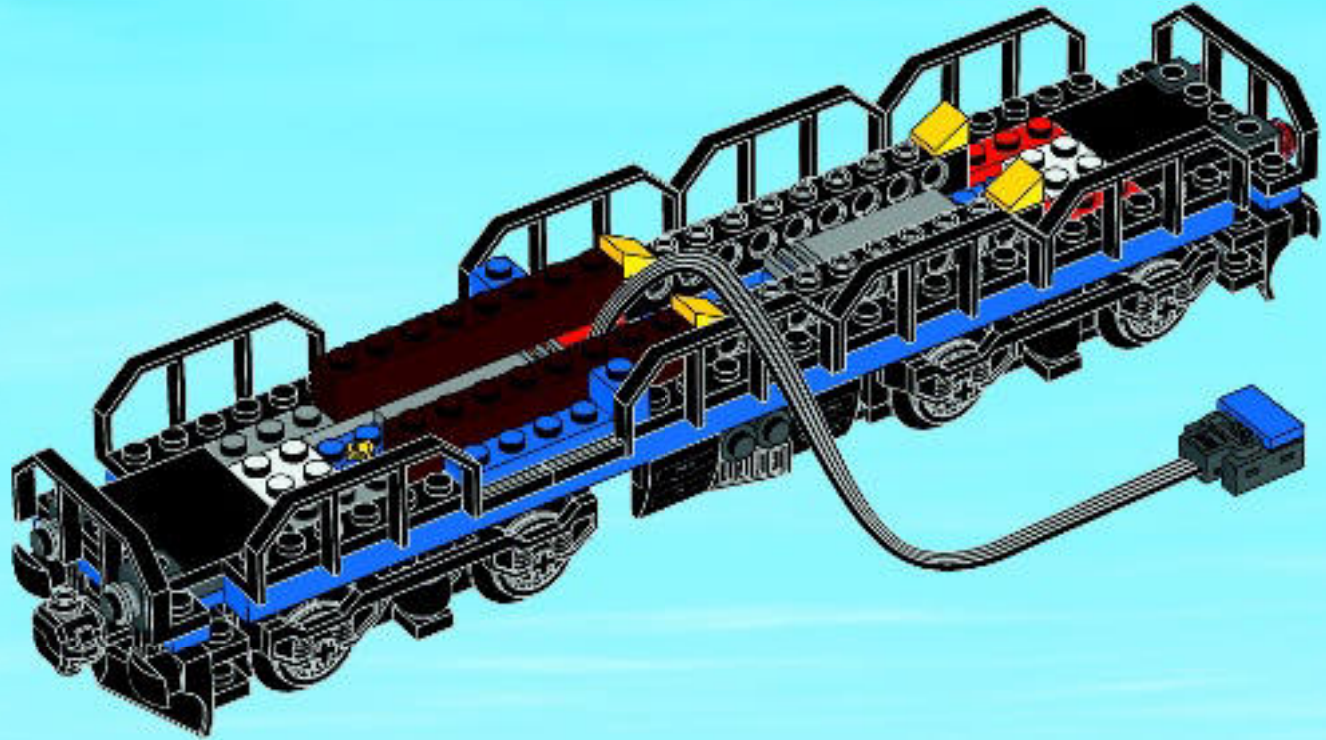



1x



2x

17

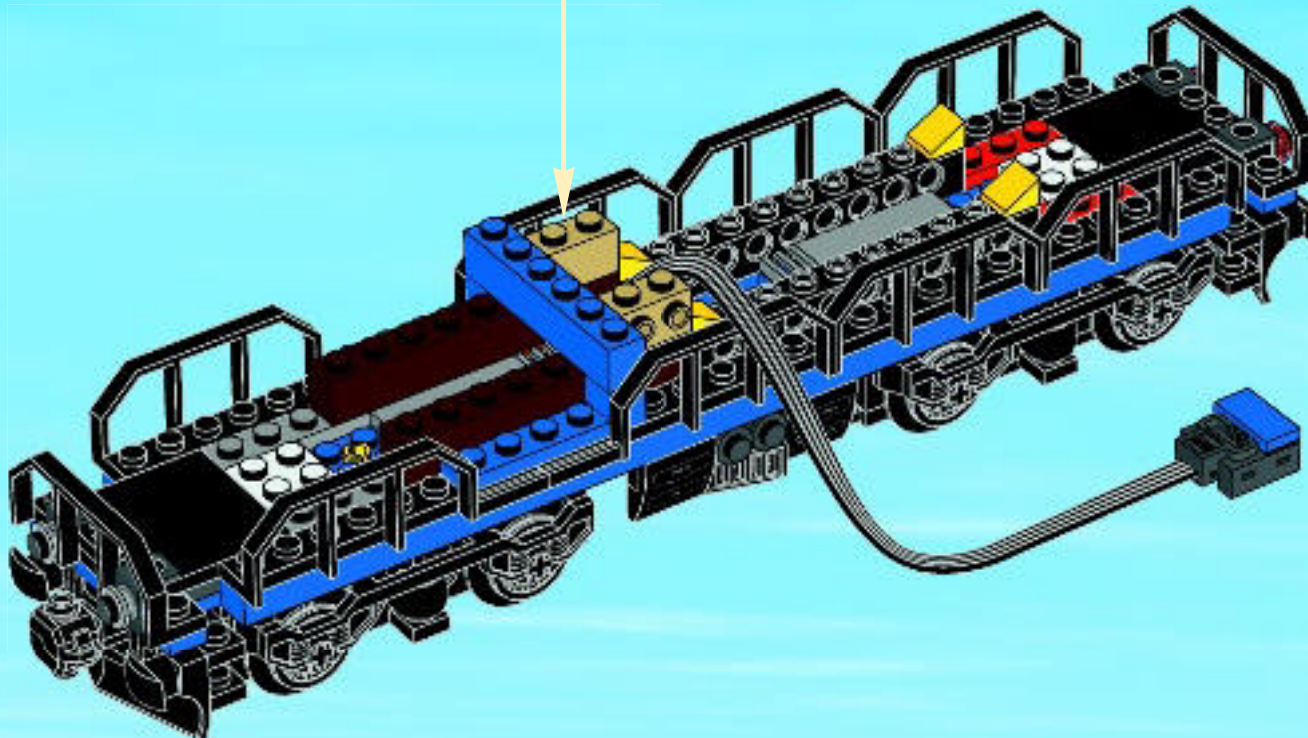



2x

18

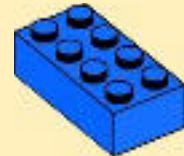

2x

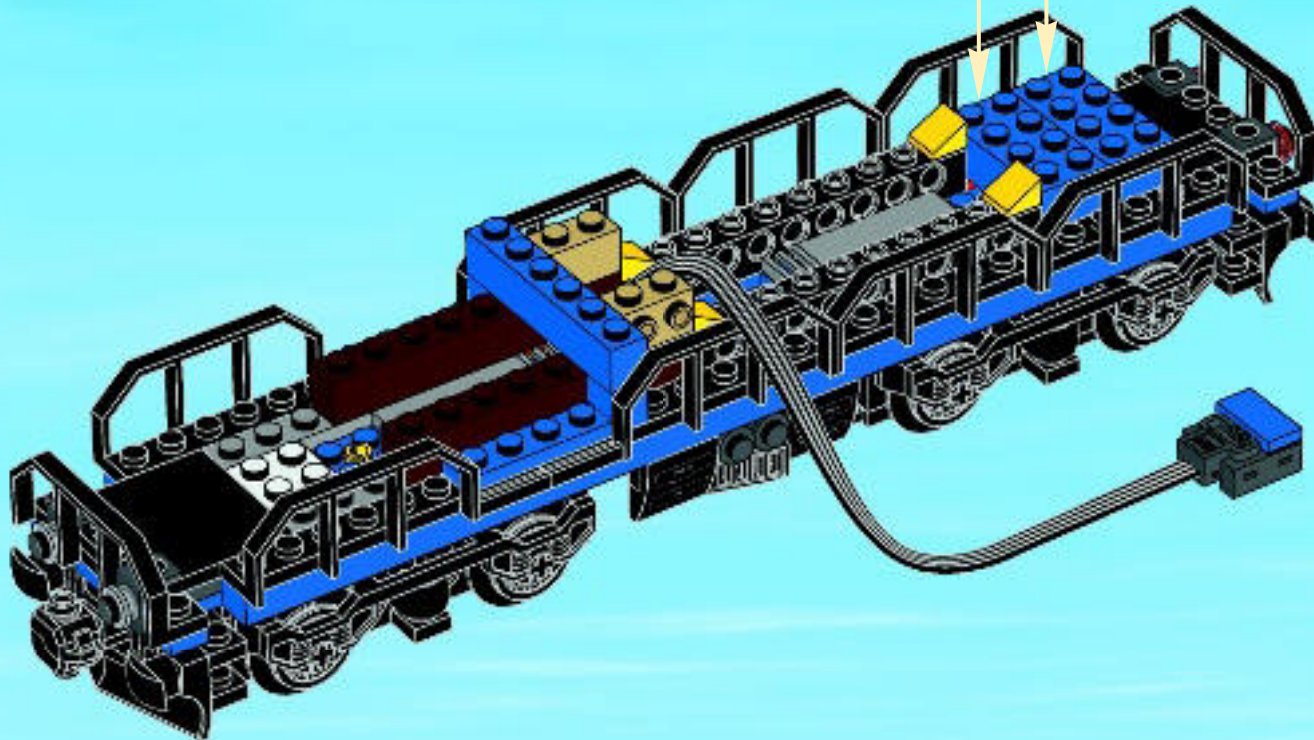



19

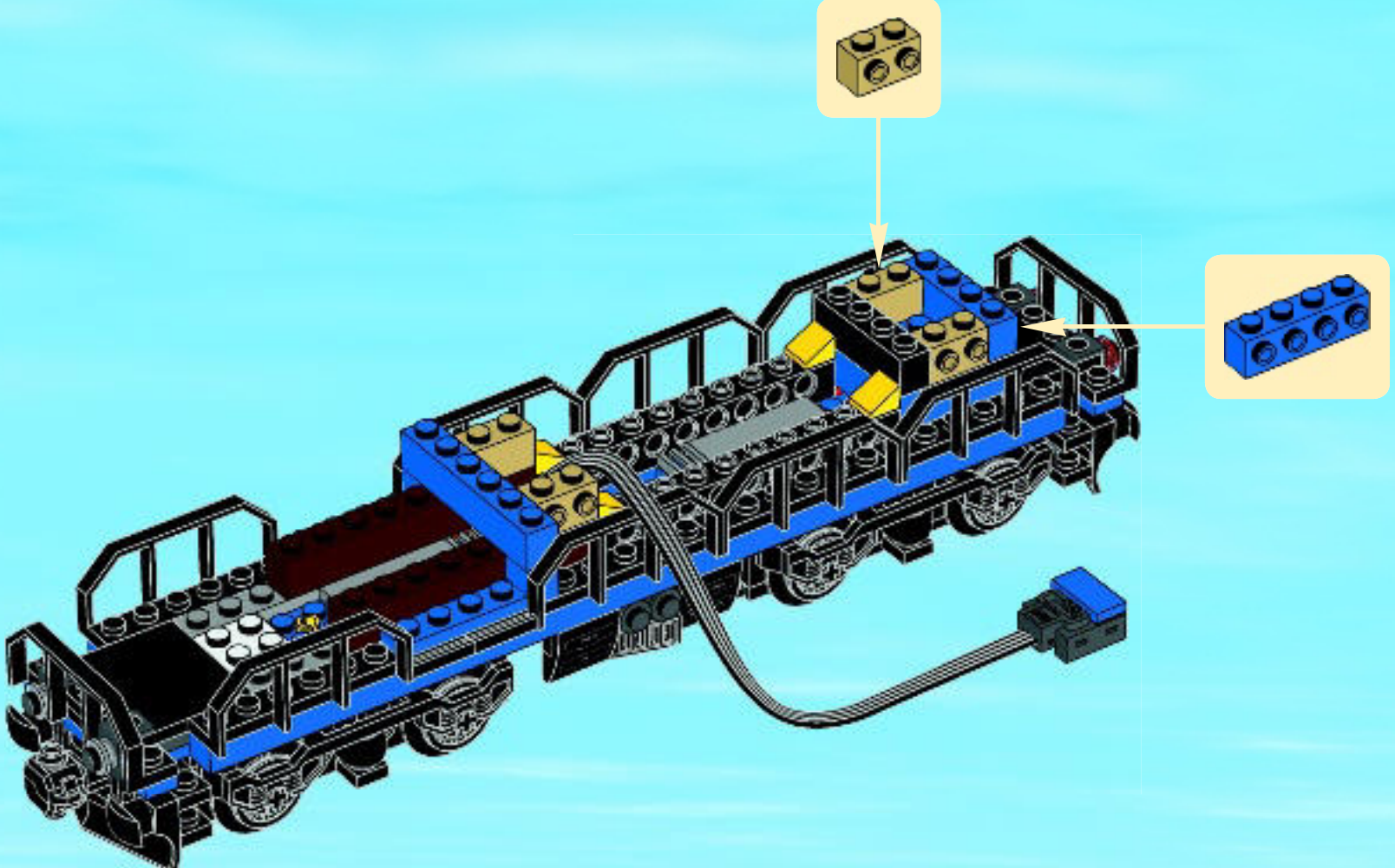



20

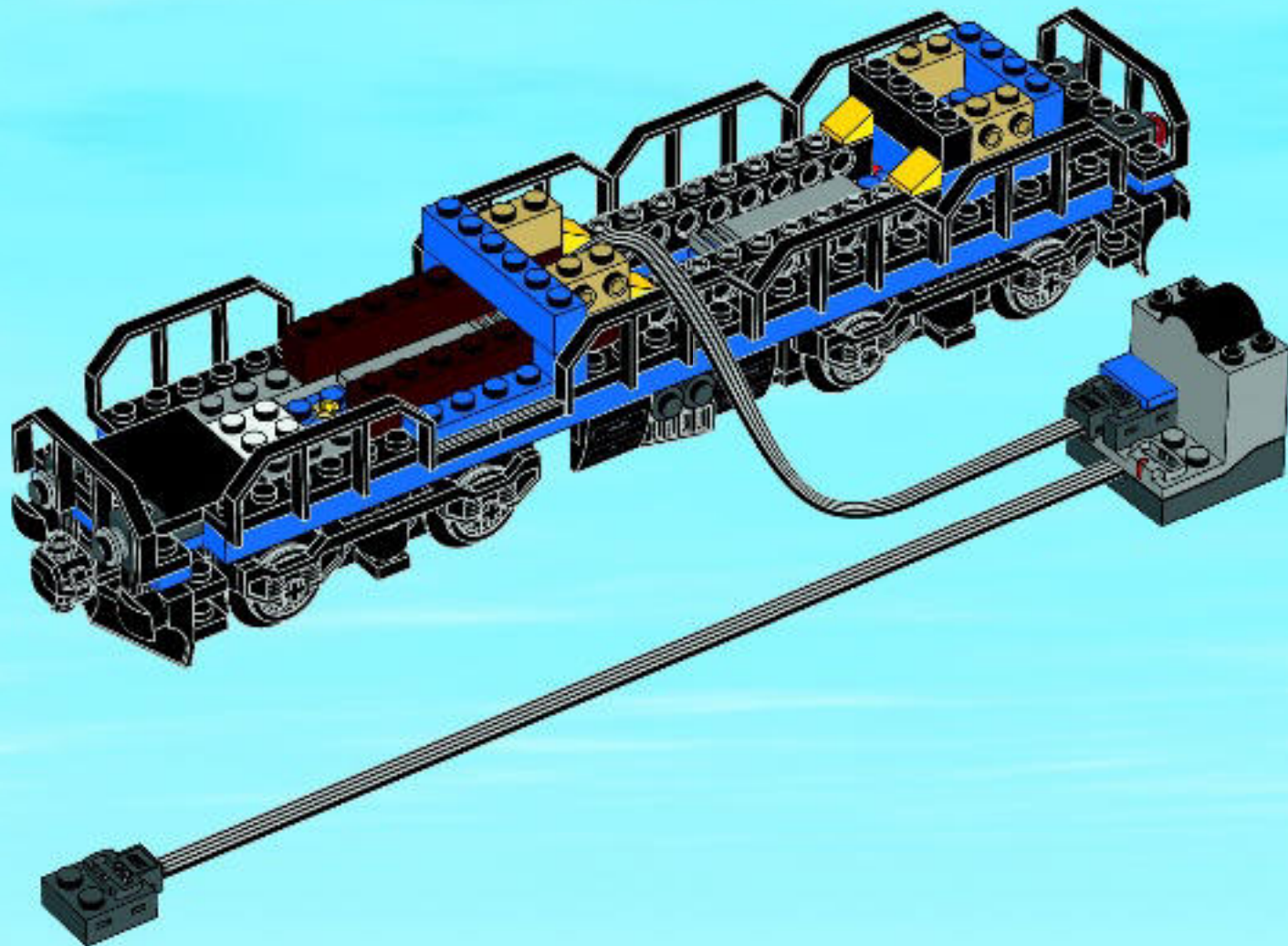

21

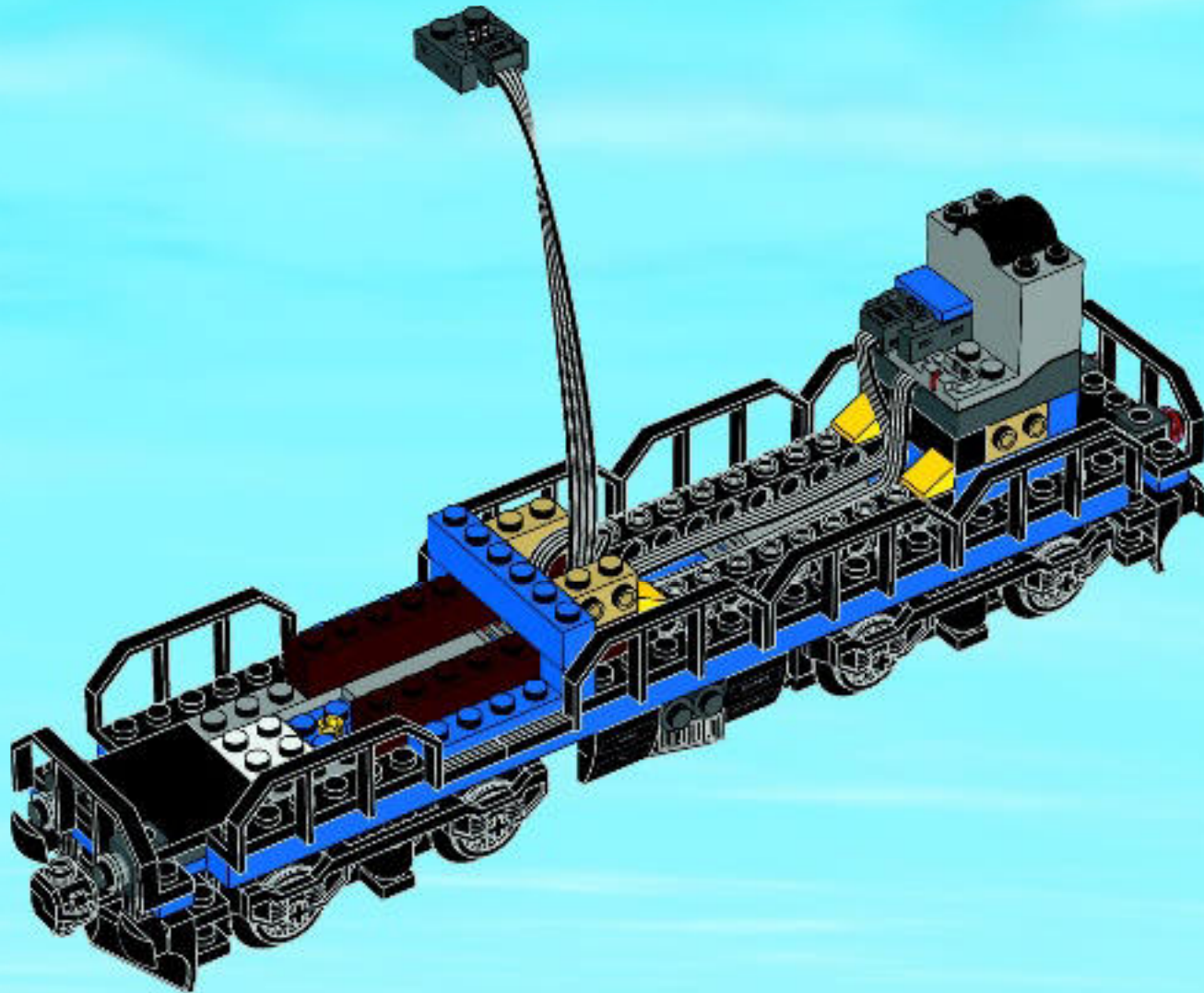



2x

22

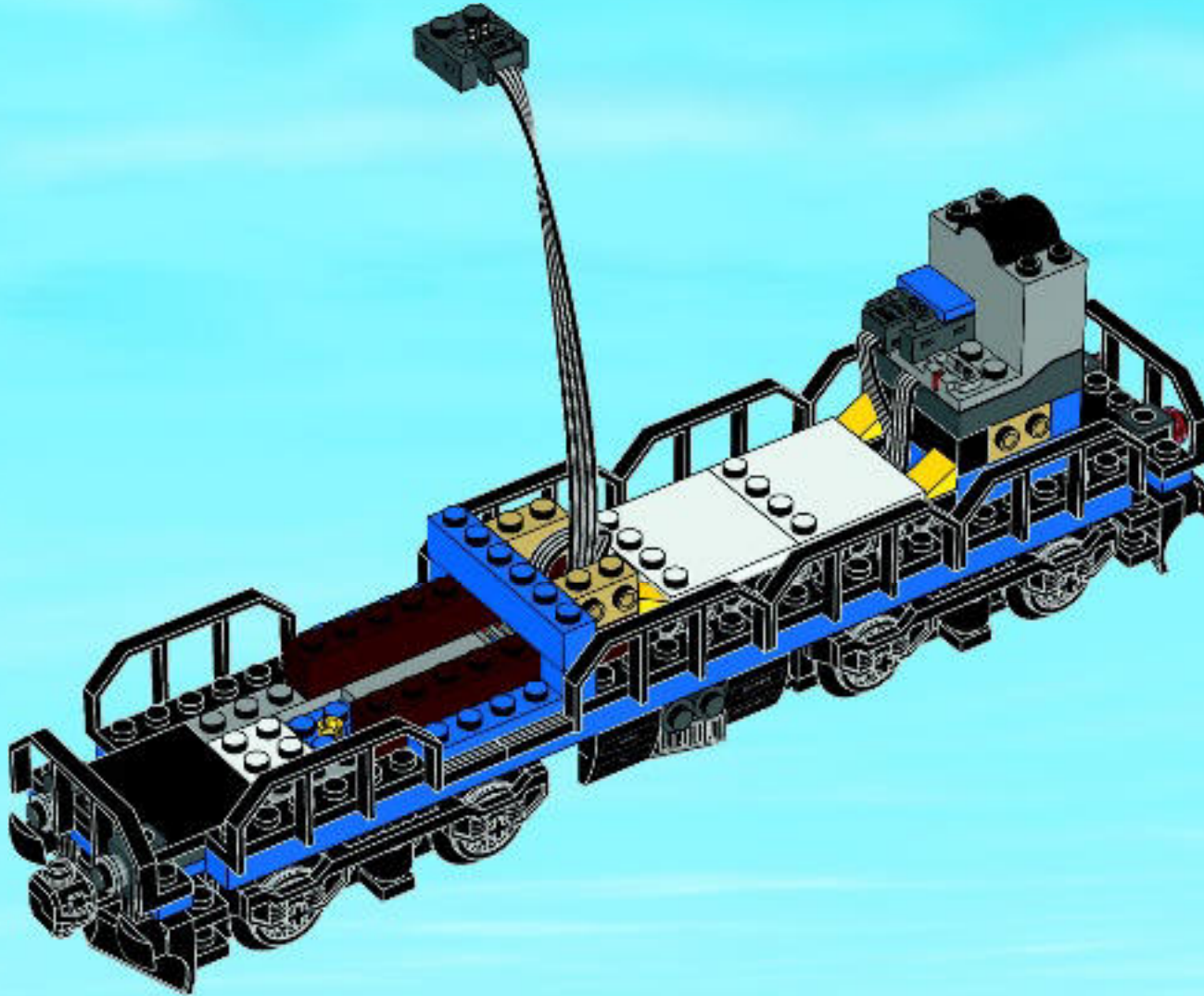



23

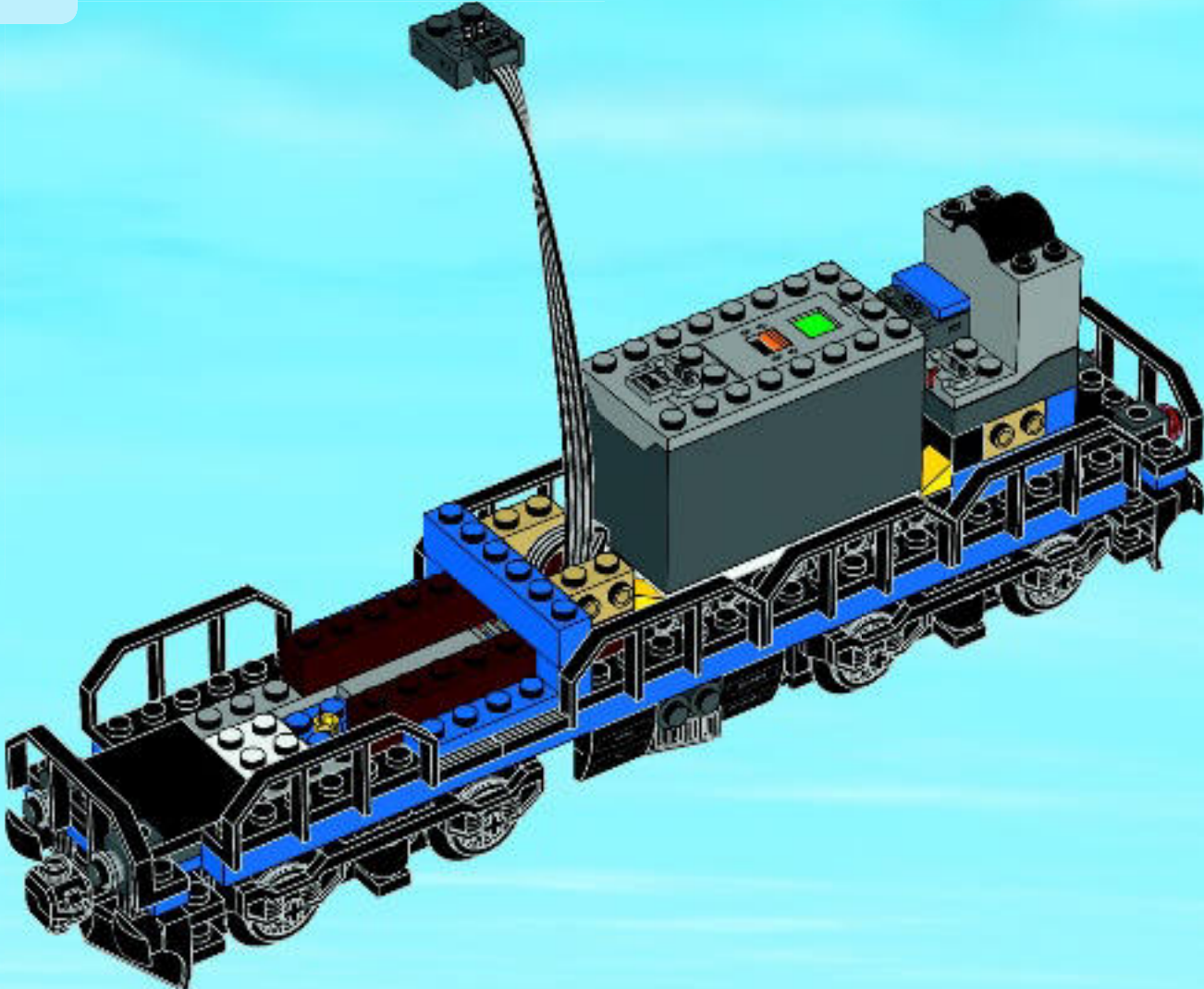

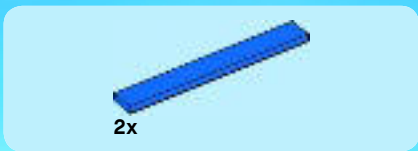

24





1x



1x

25

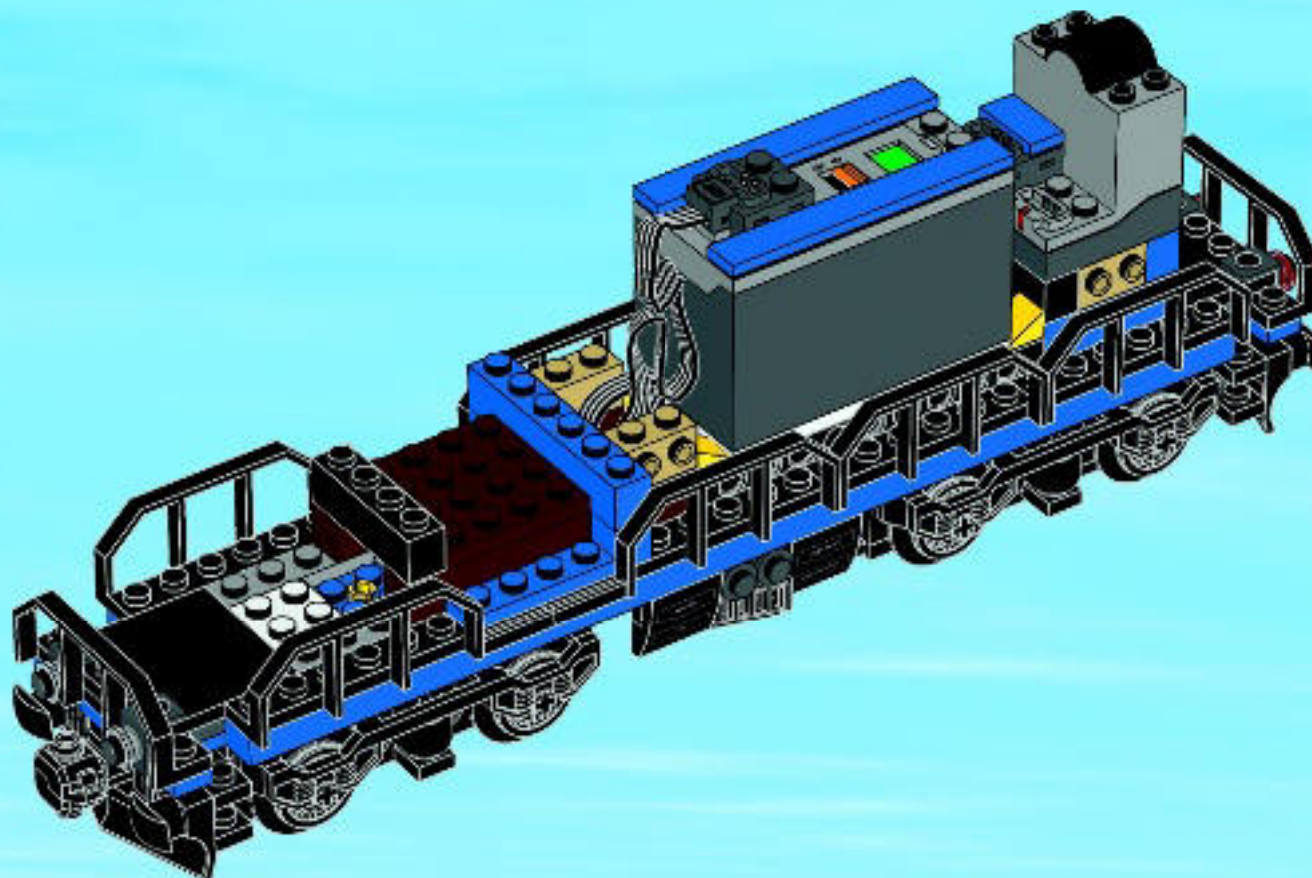



1x



4x

26

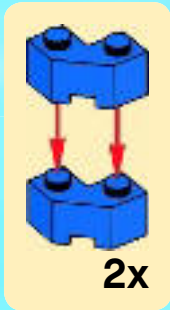

2x

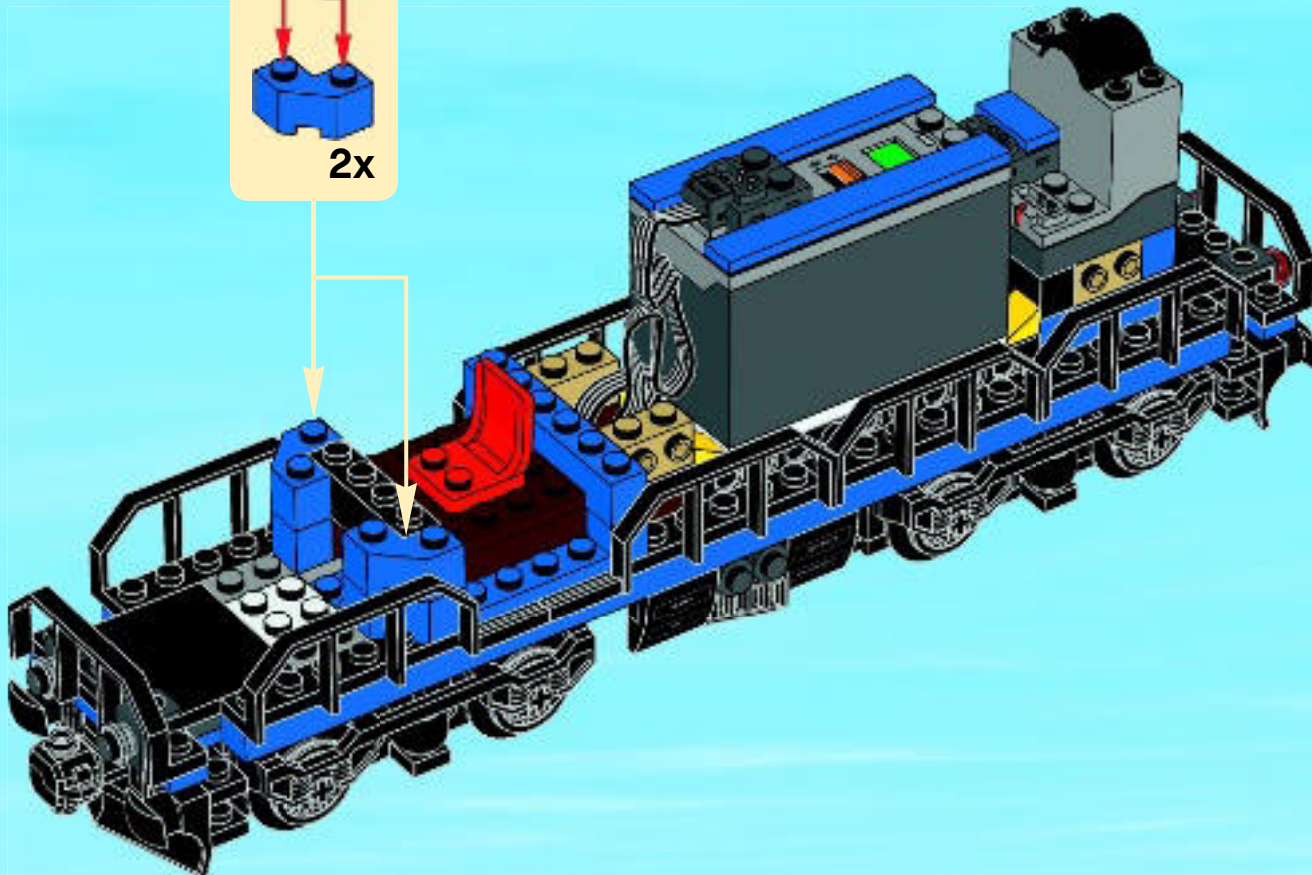



4x

27

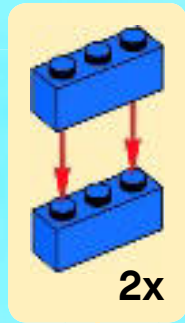

2x

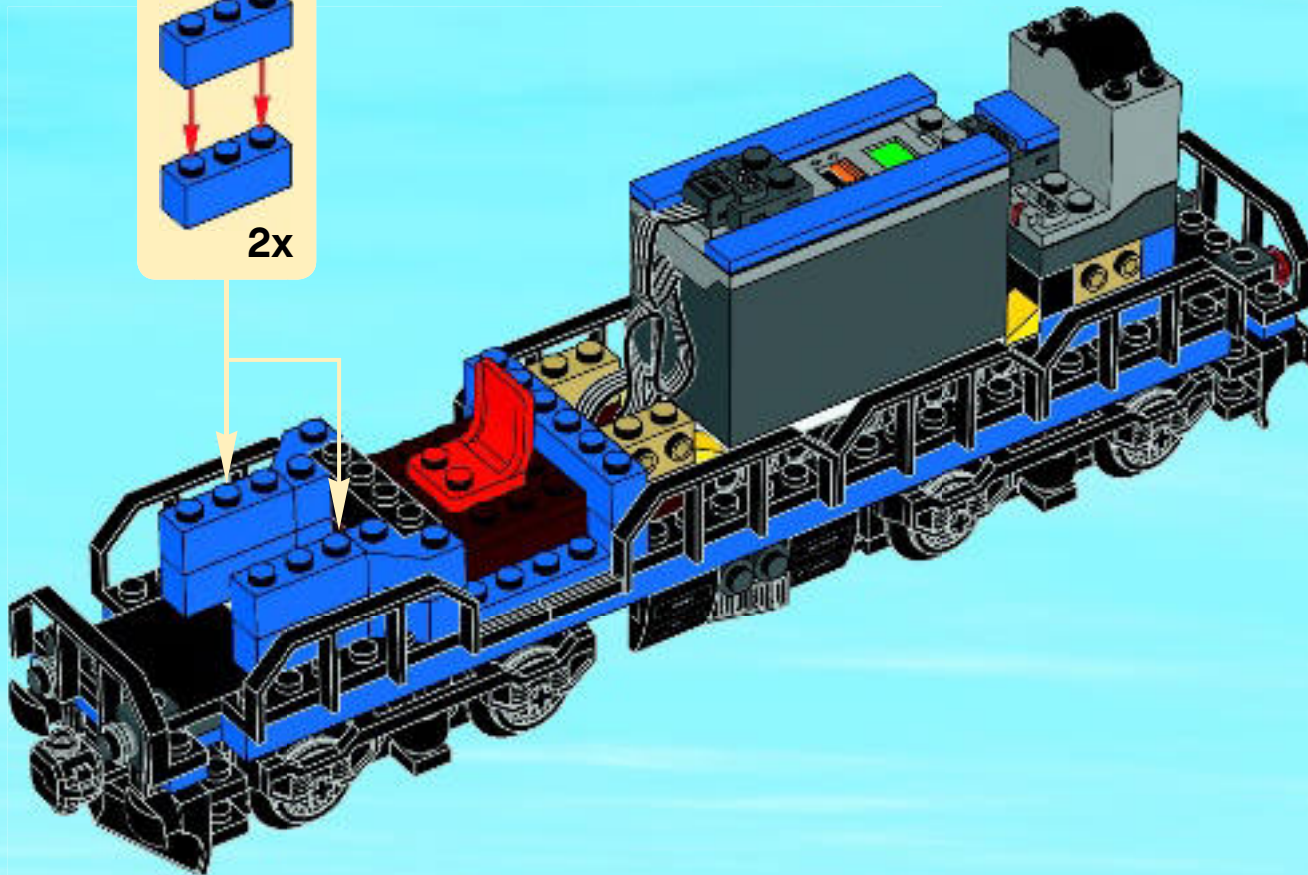



3x



2x

28

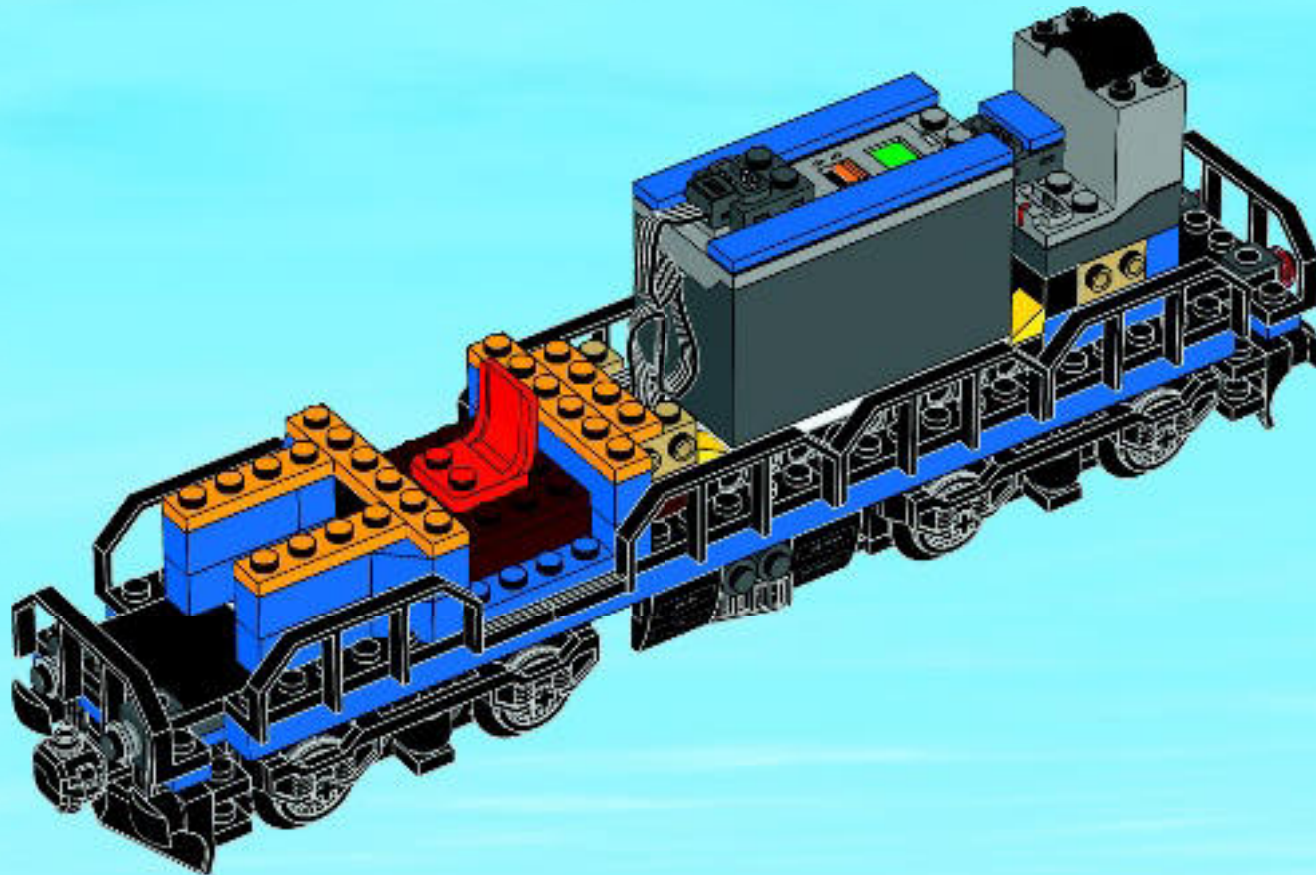



1x



2x

29

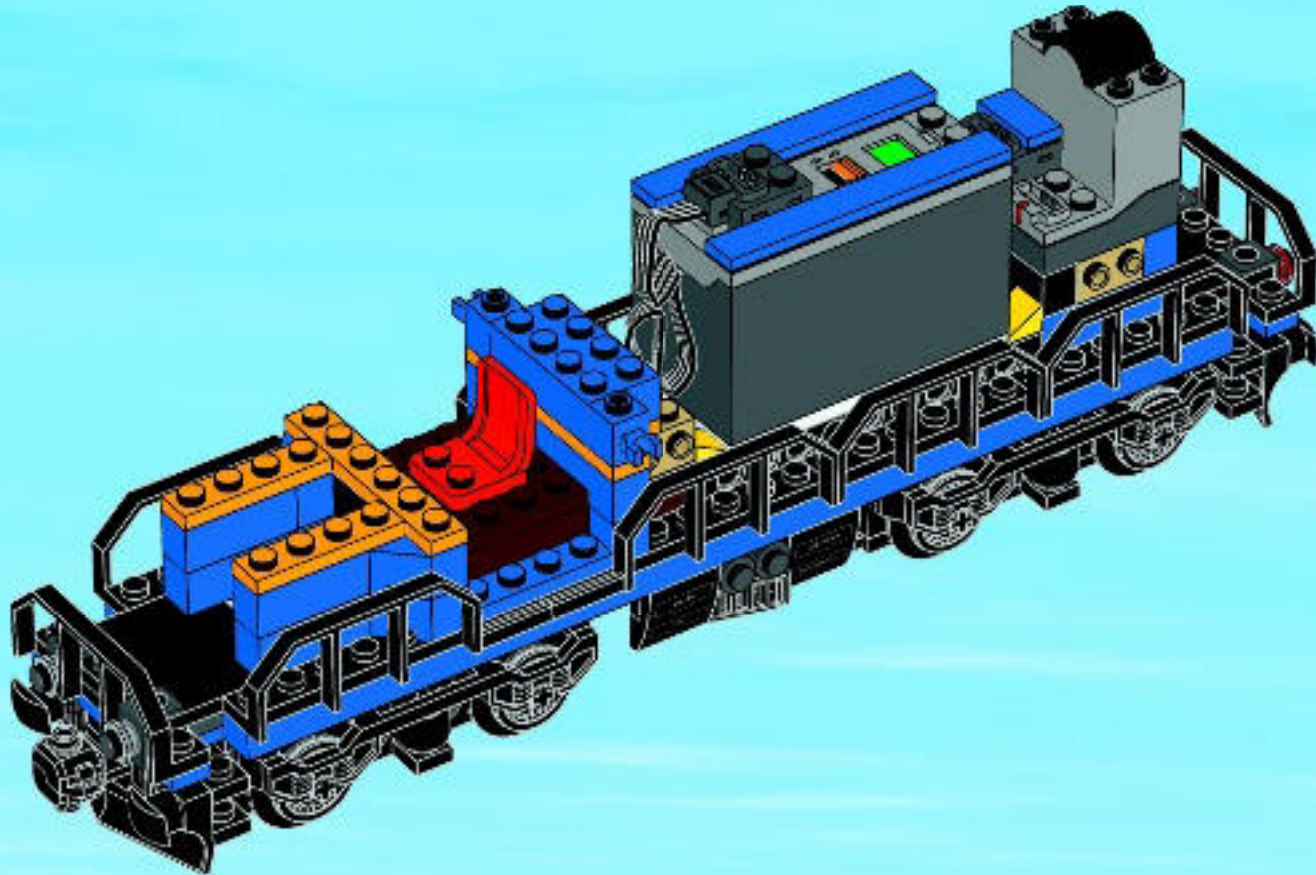



1x



1x

30

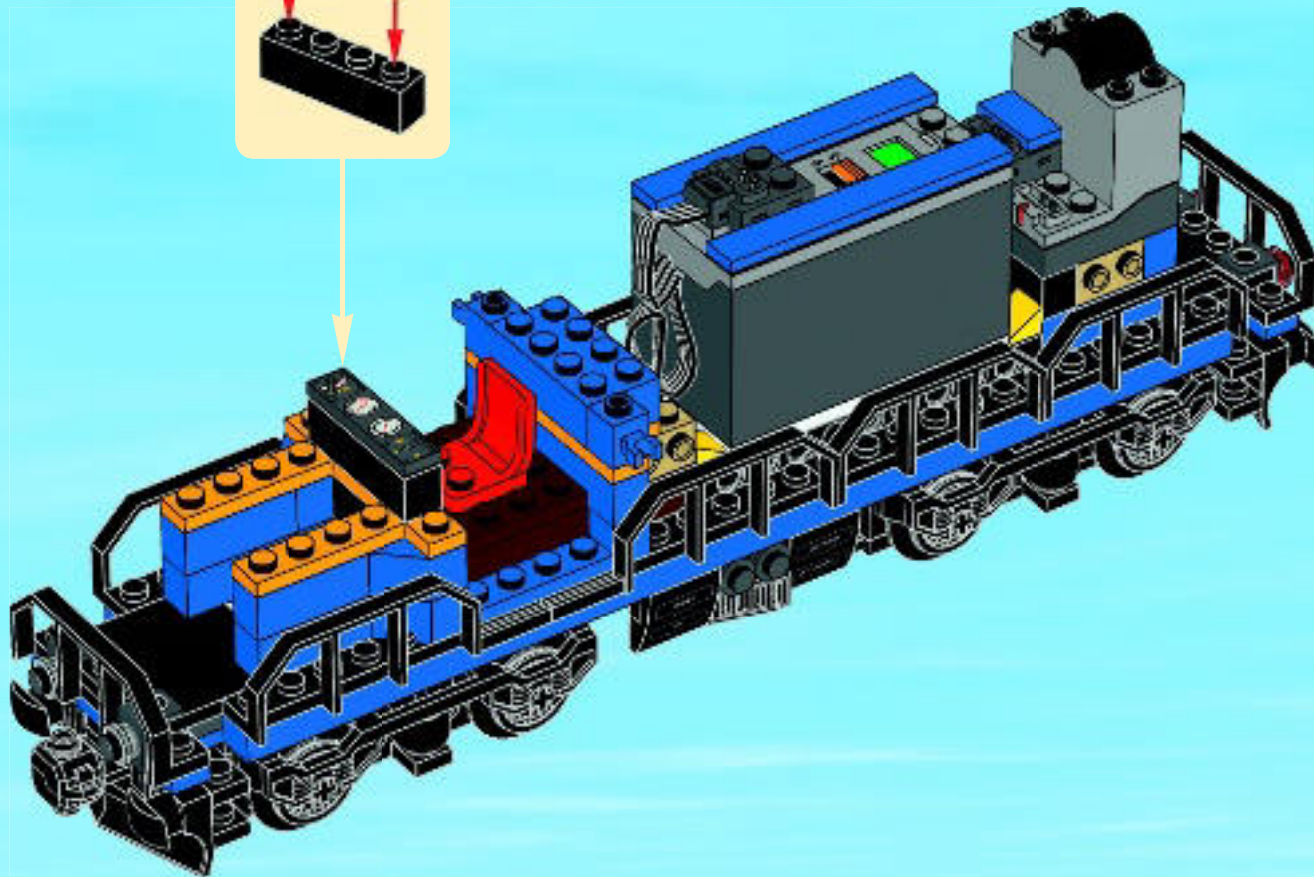
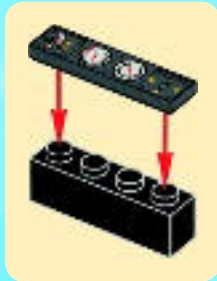

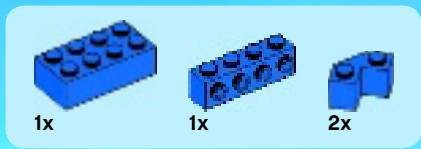

31

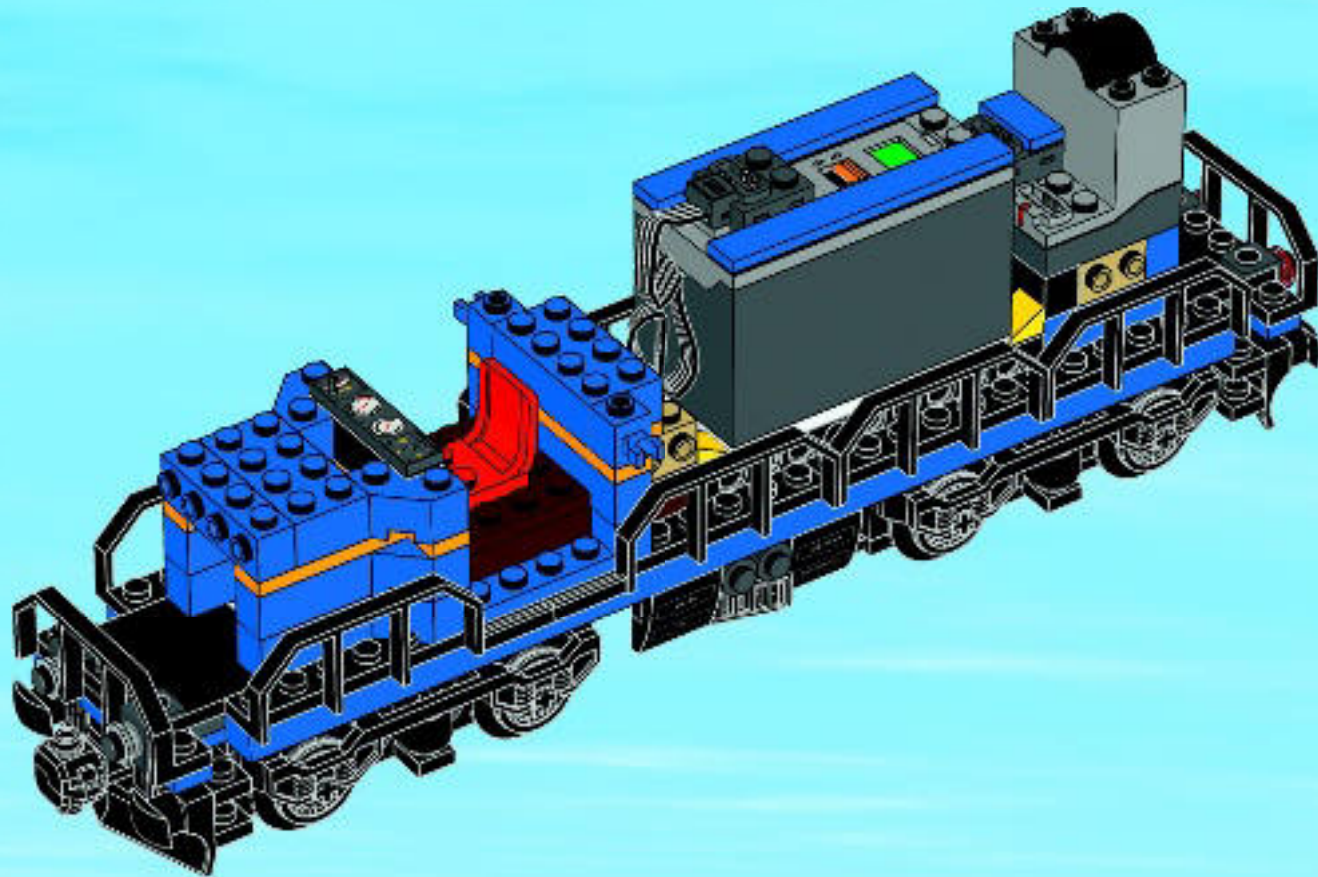

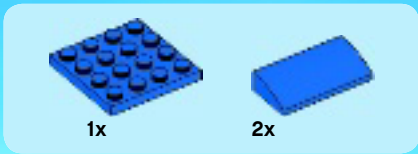

32

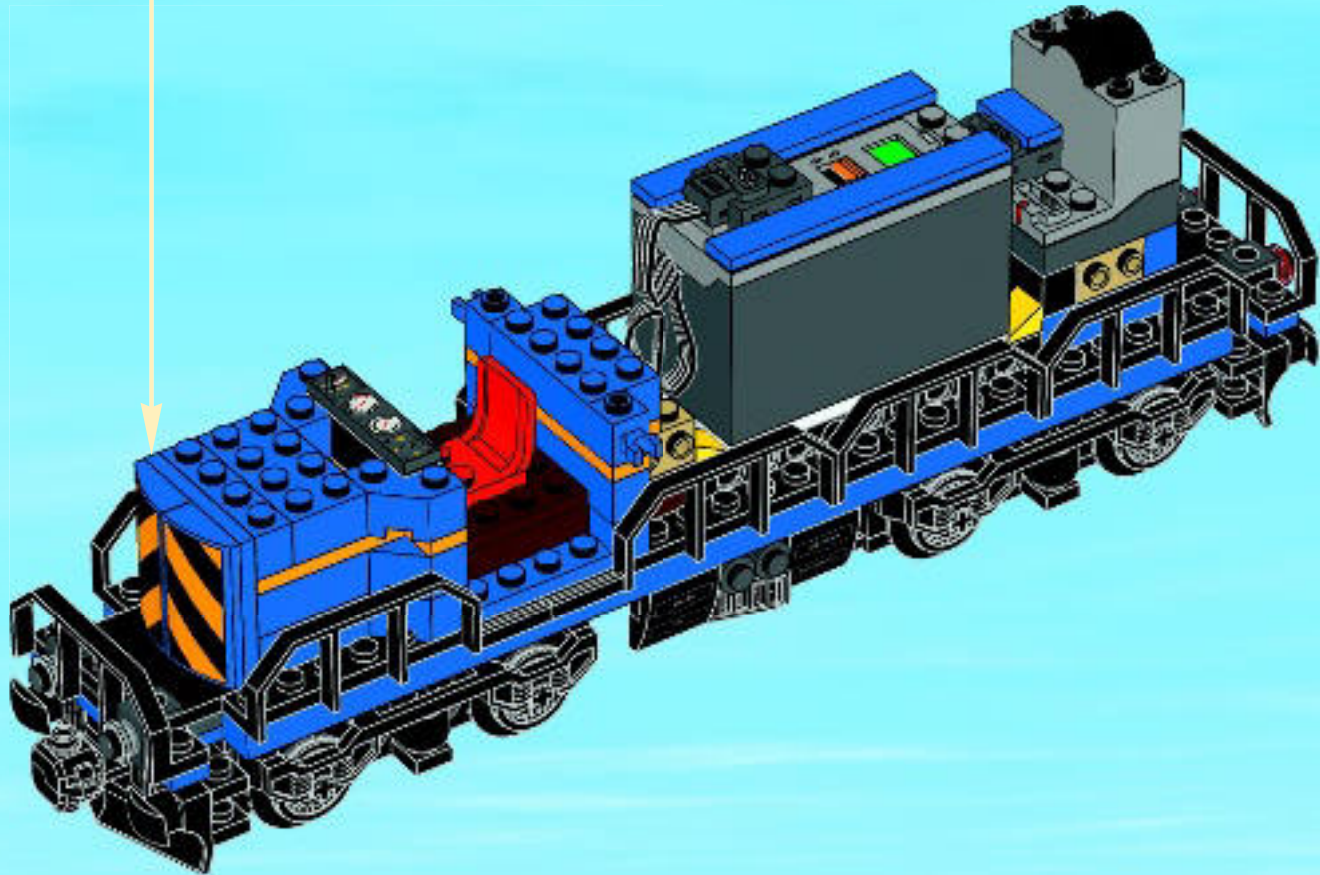
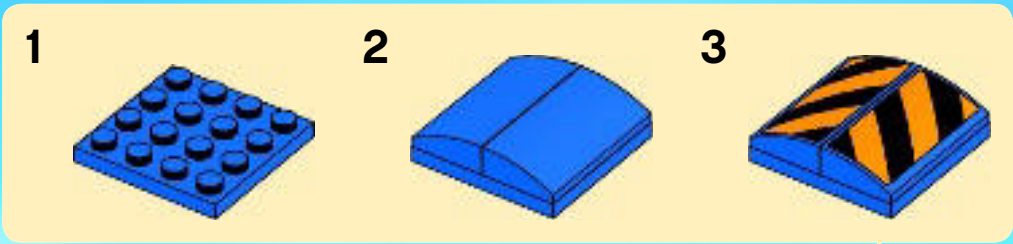

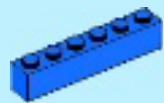

1x



1x

33

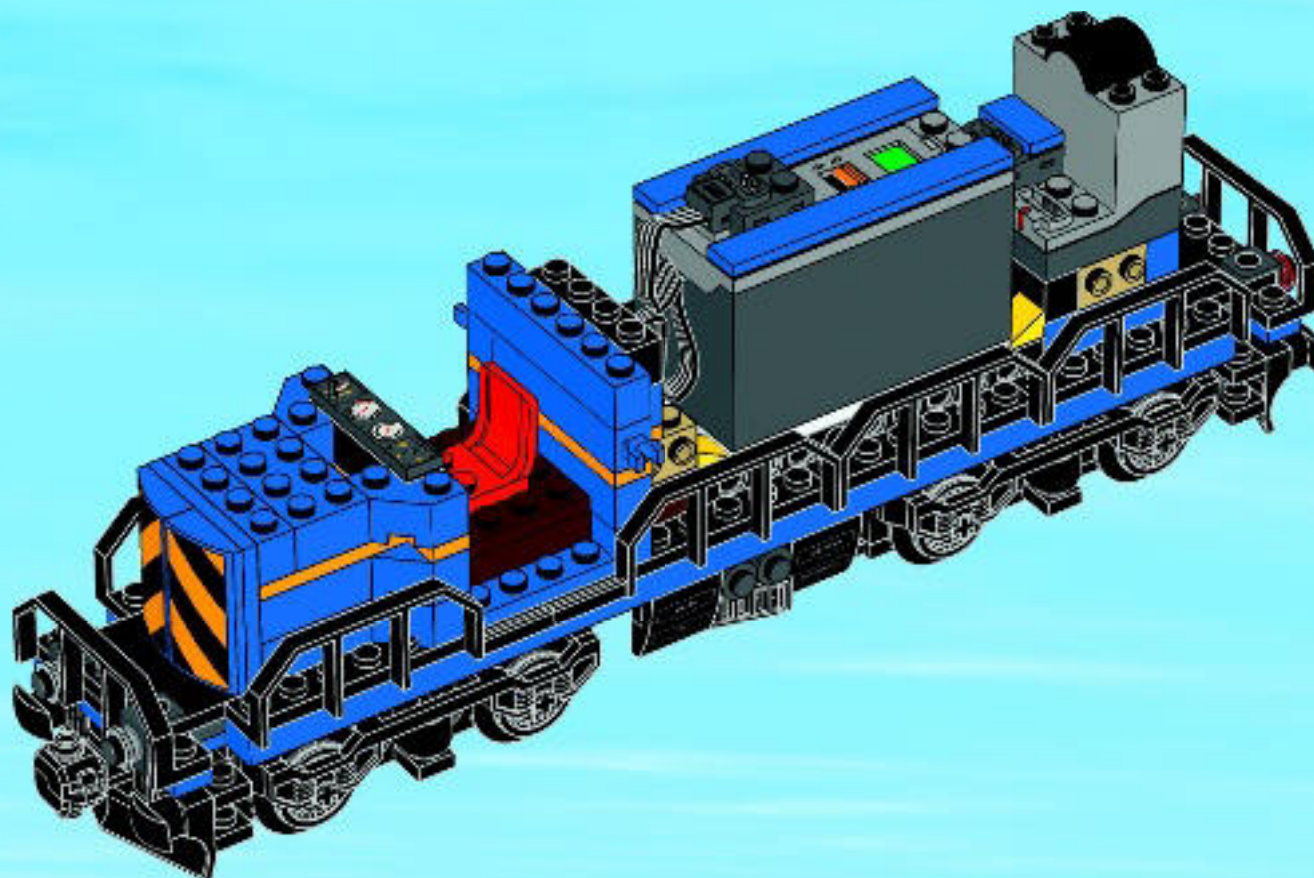



2x



2x

34





1x



2x

35

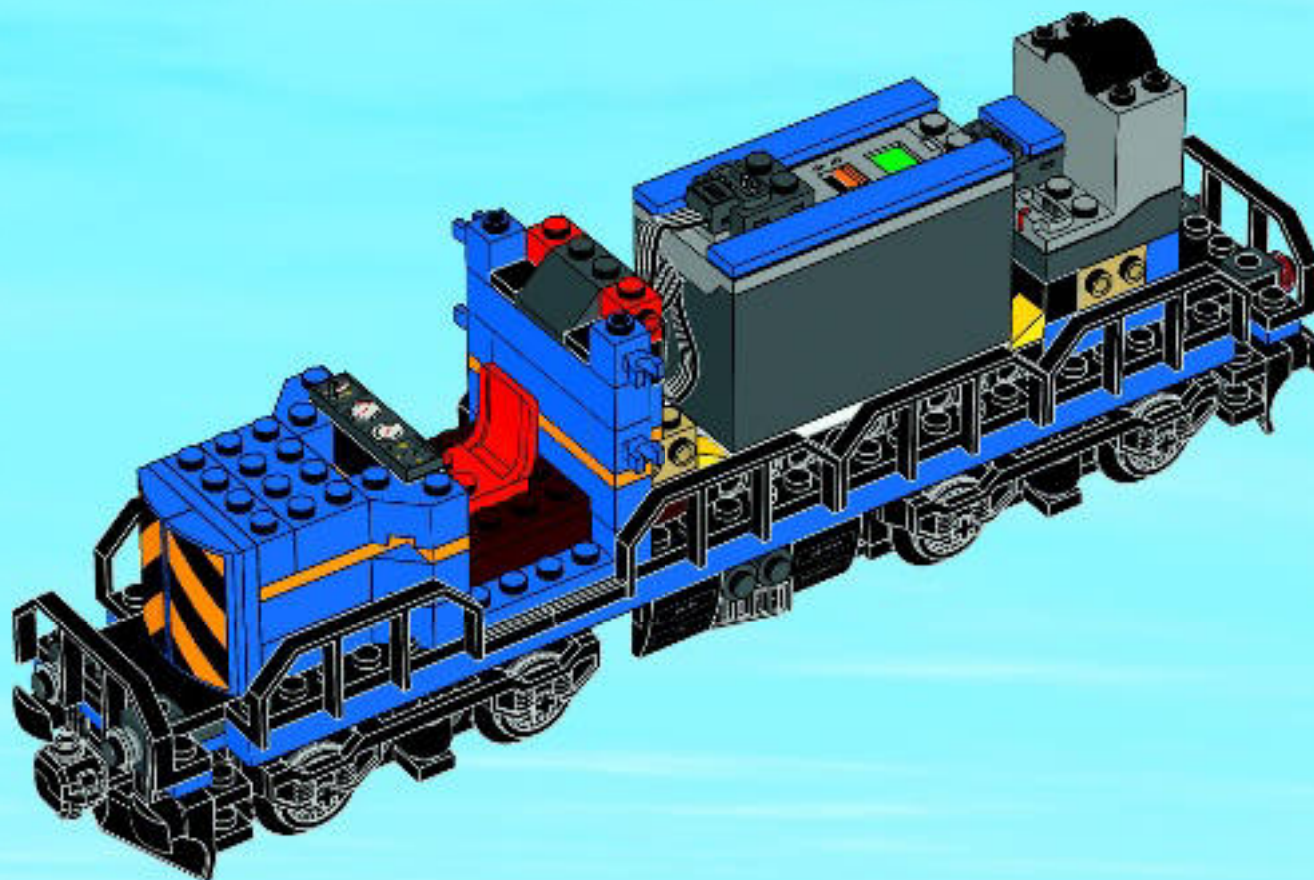

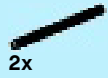

2x

36



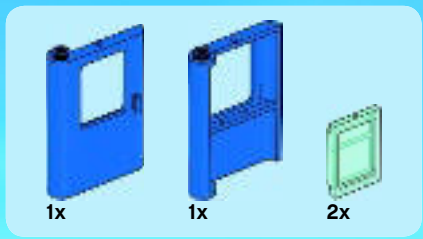

37

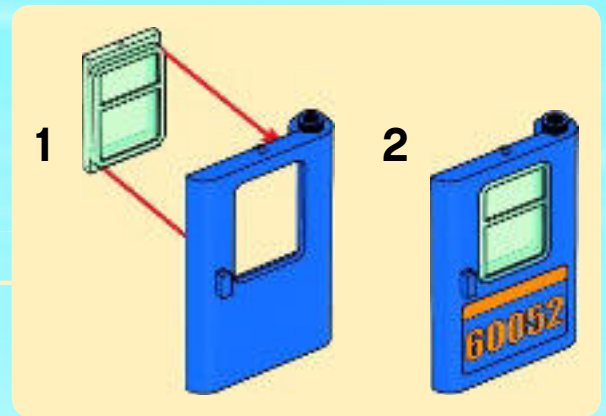
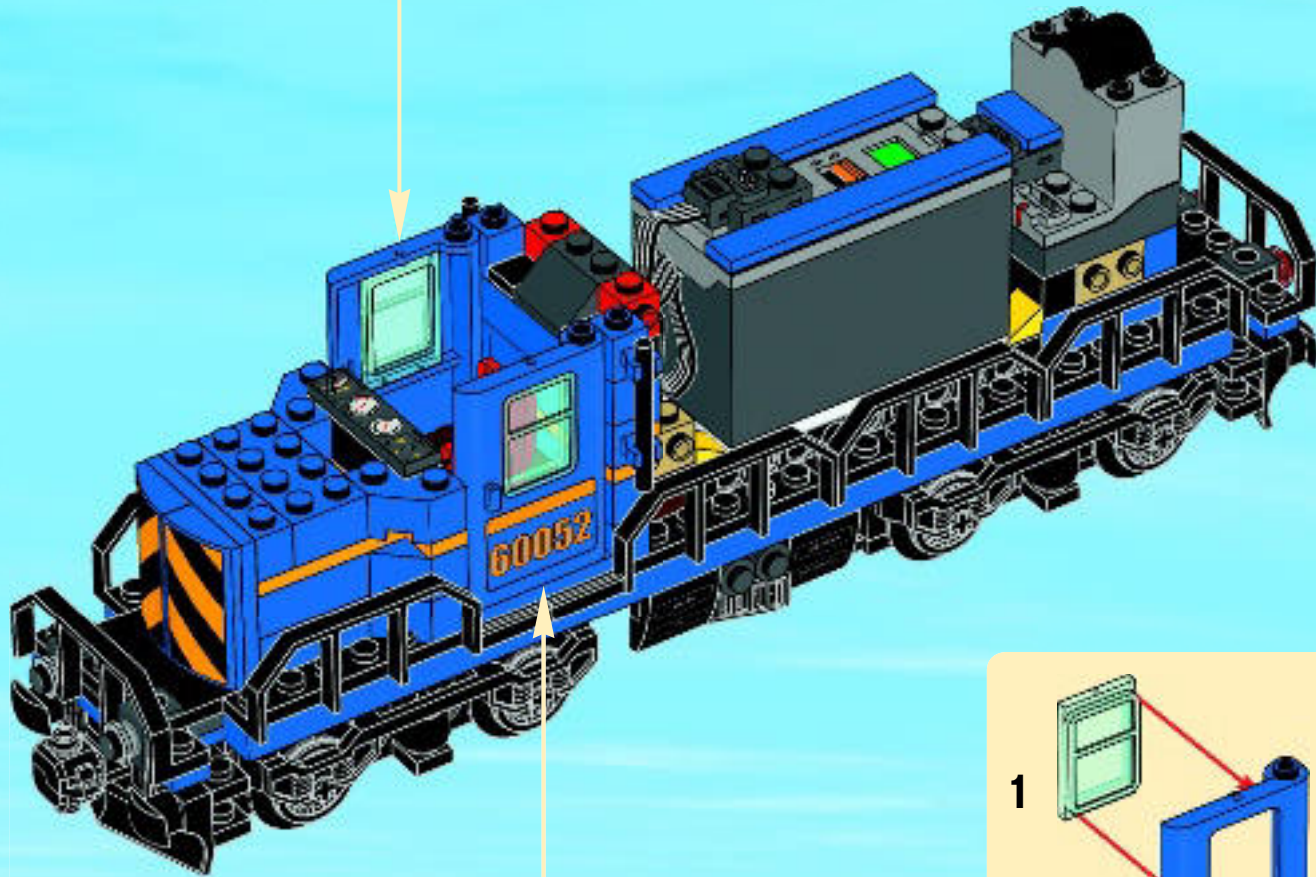
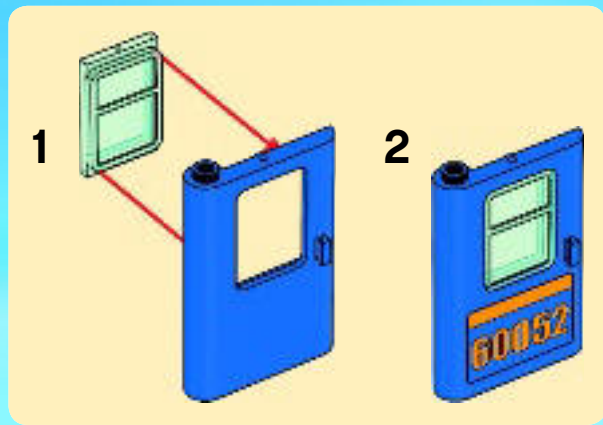

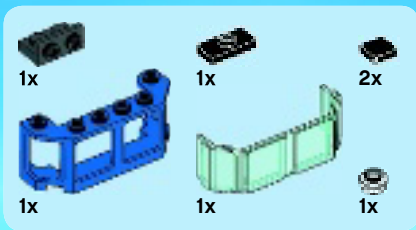

38

1

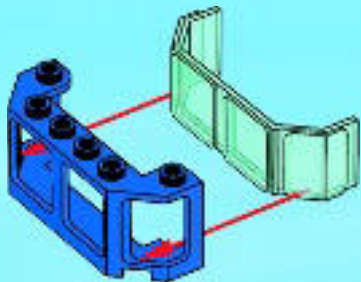

2



3

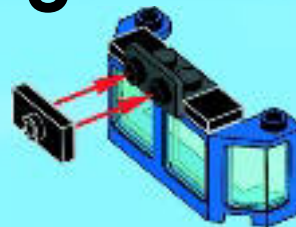

4







2x

39



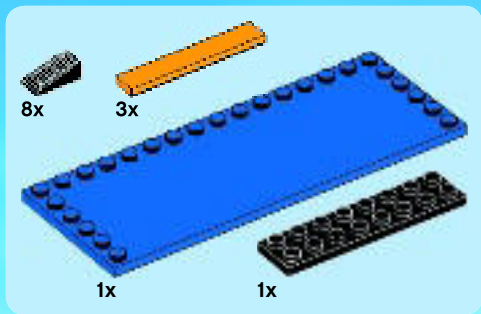

40

1

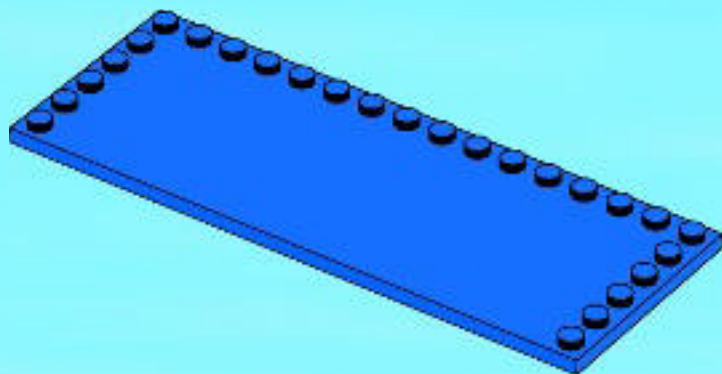

2

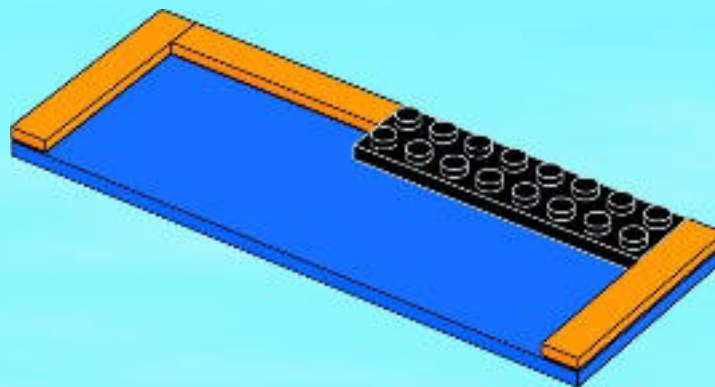

3

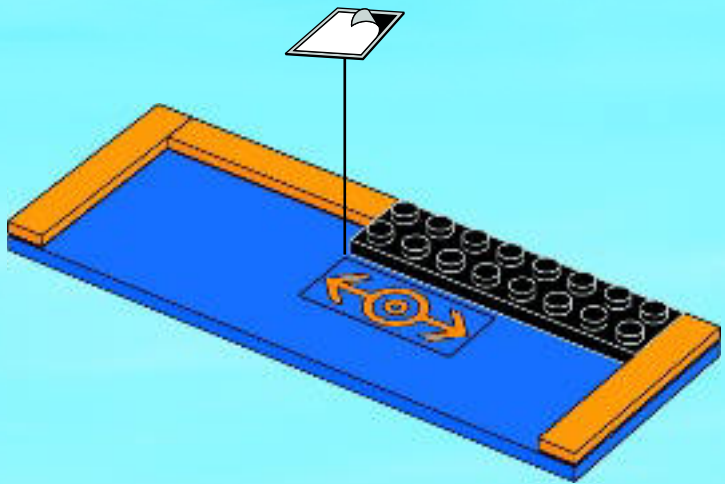

4

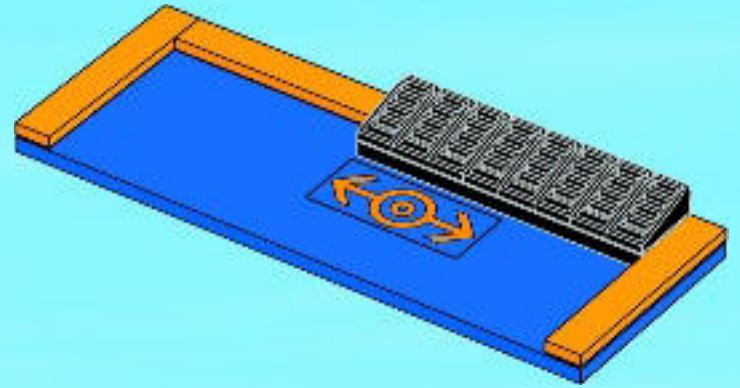



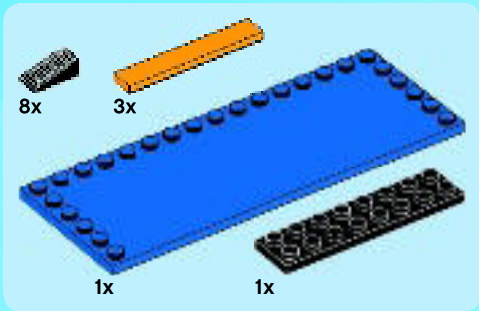

41

1

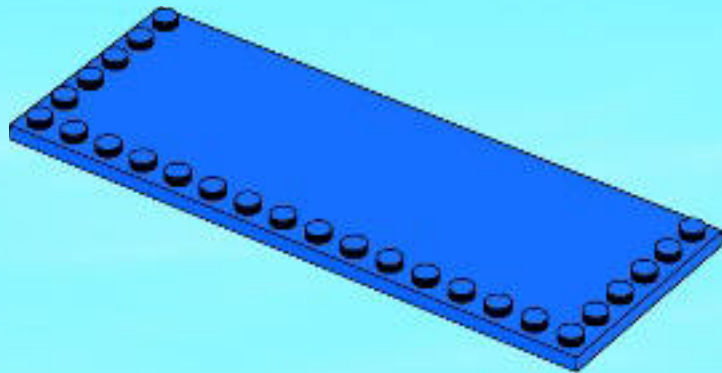

2

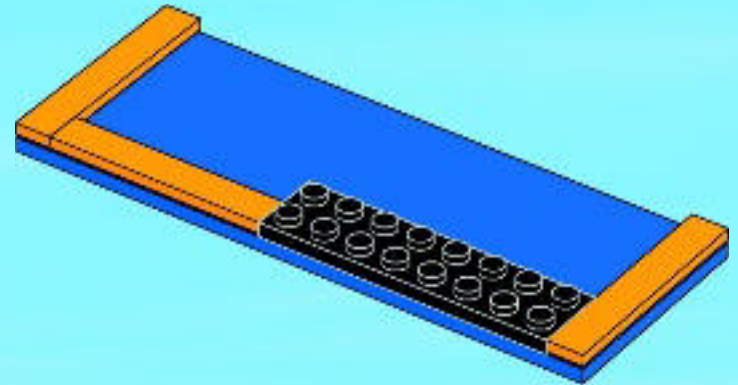

3

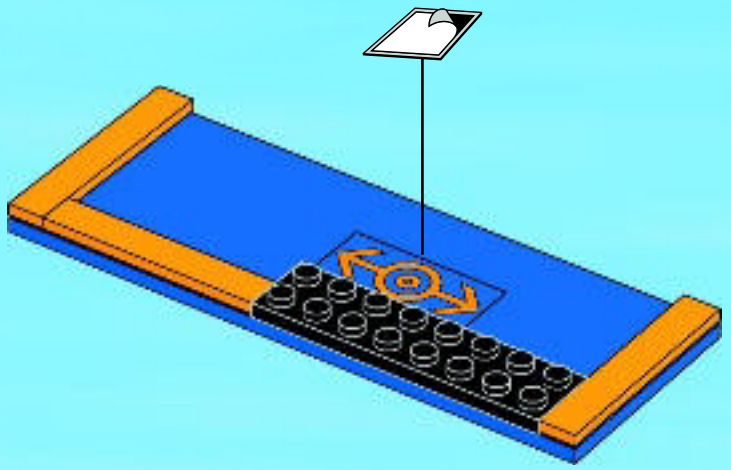

4

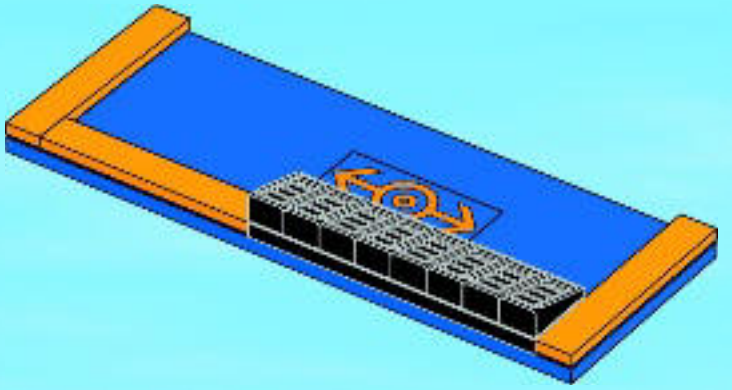



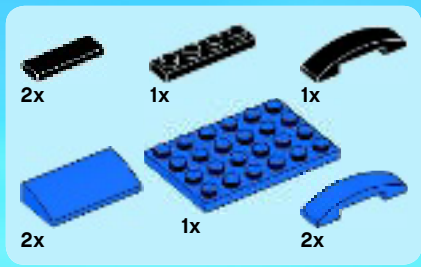

42

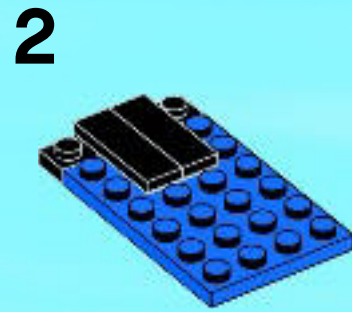
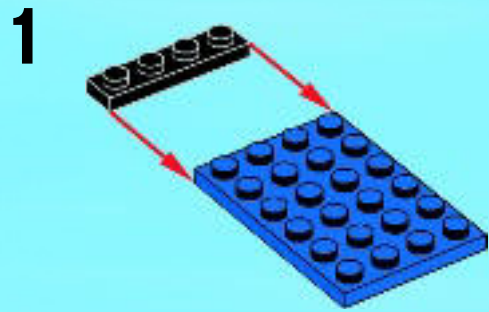

5





1

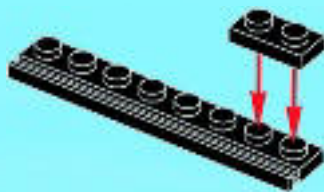

2

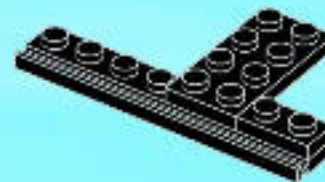



3

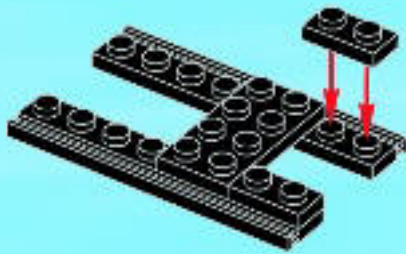

4

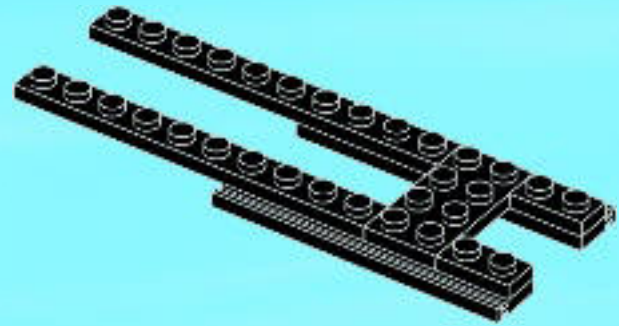



2x

5

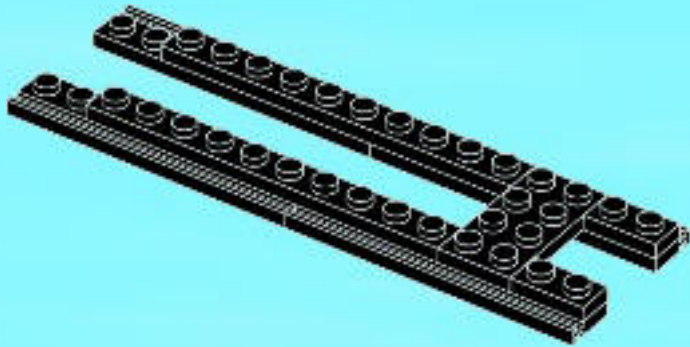

2x

6

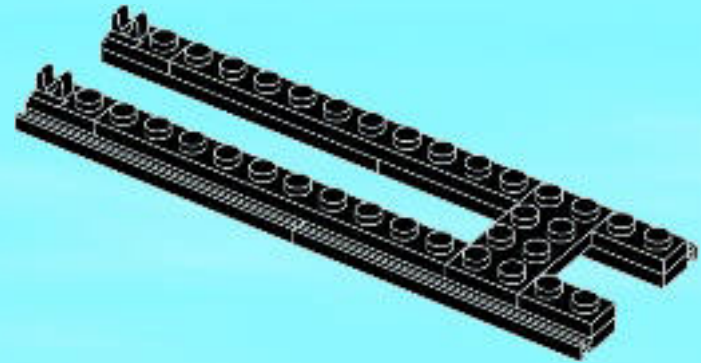



7

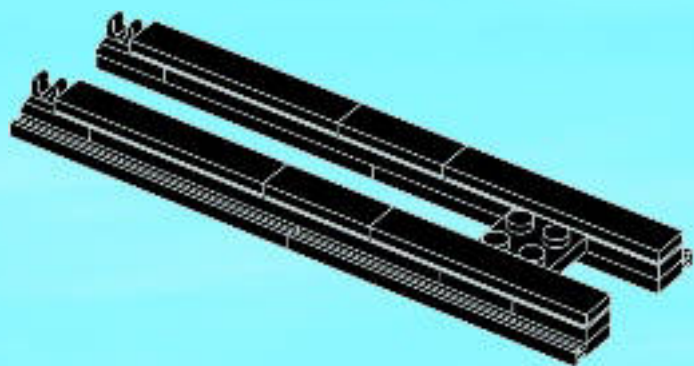

8

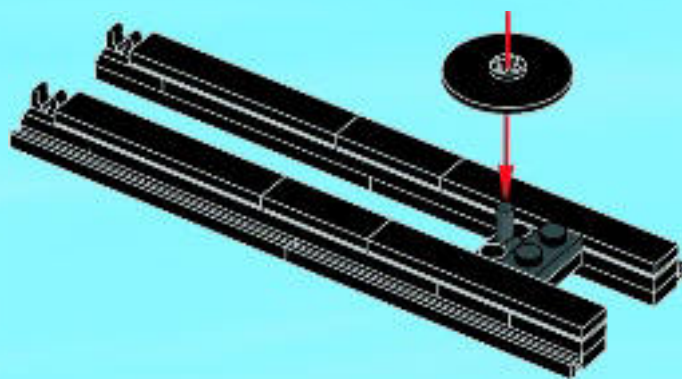

43



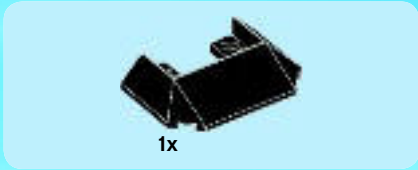

1x

1

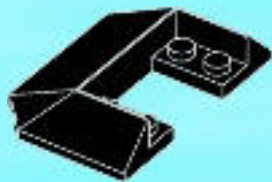

1x

2



6x

3

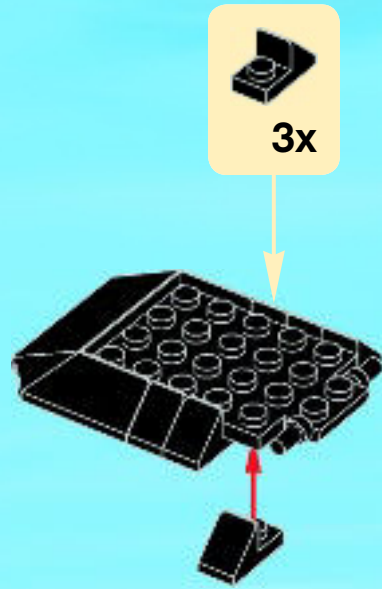

3x



2x

4

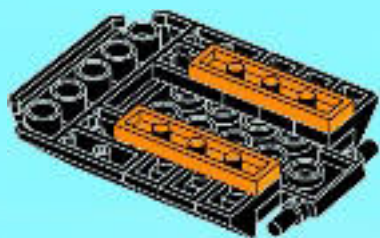

2x

5



2x

6

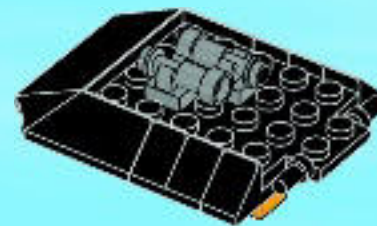

44

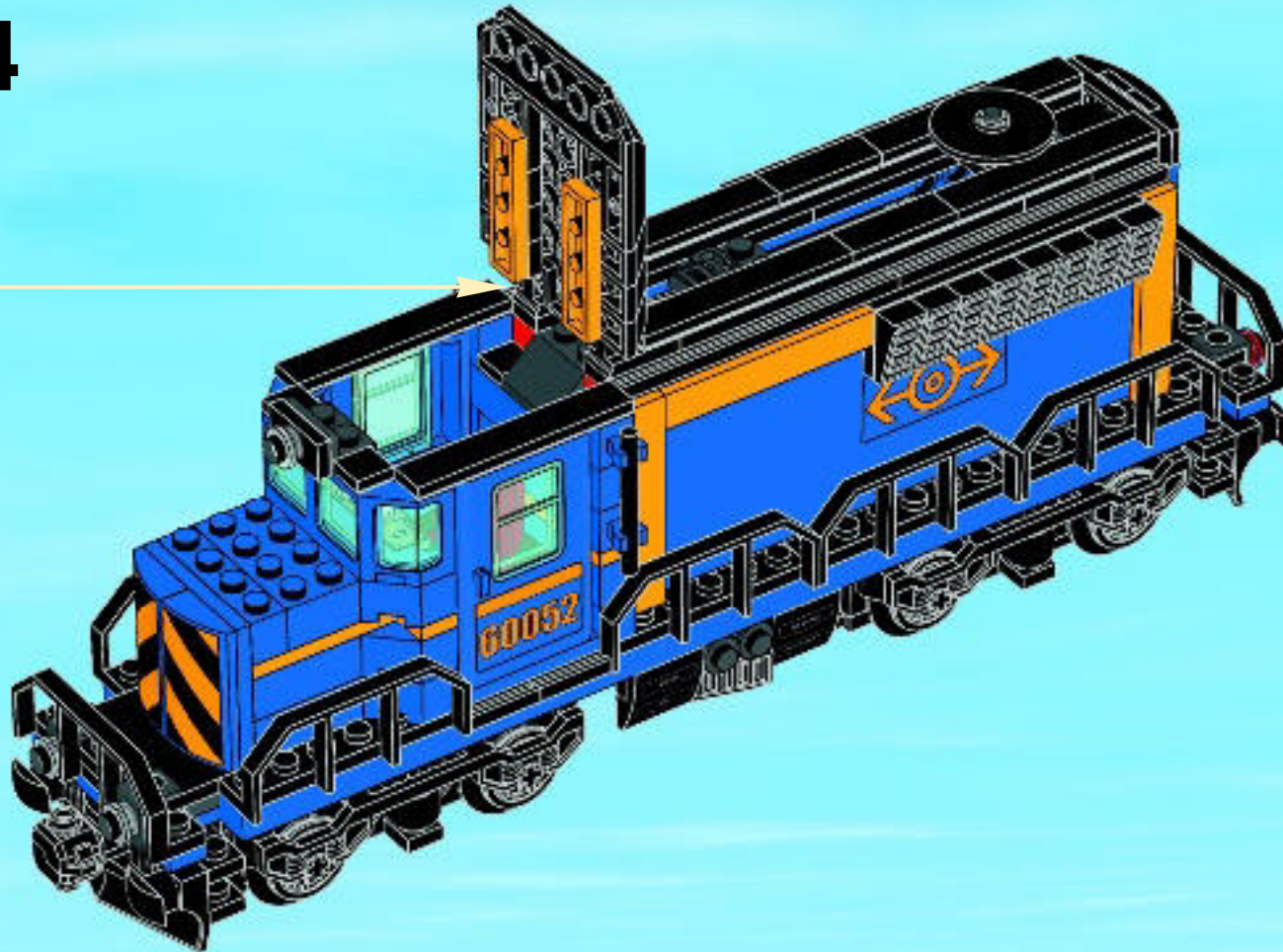



45

1



2



3

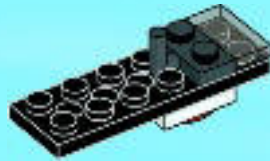

4



5



6



46



on/off

An/Aus

Marche/arrêt

Encendido/apagado

Ligado/Desligado

Be/ki

开/关

Hidup/mati

1

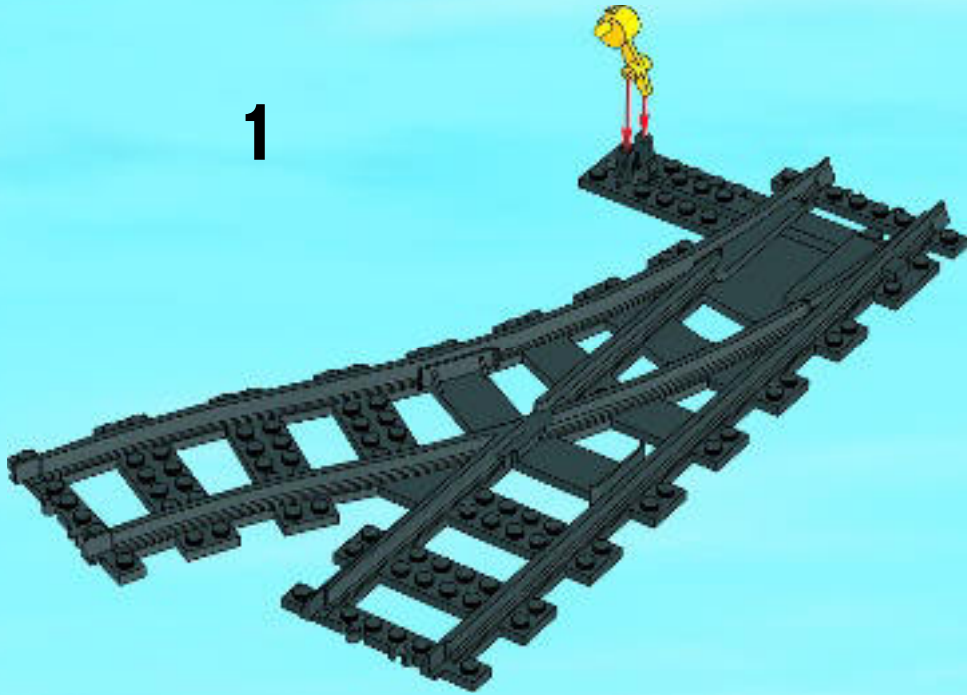

2

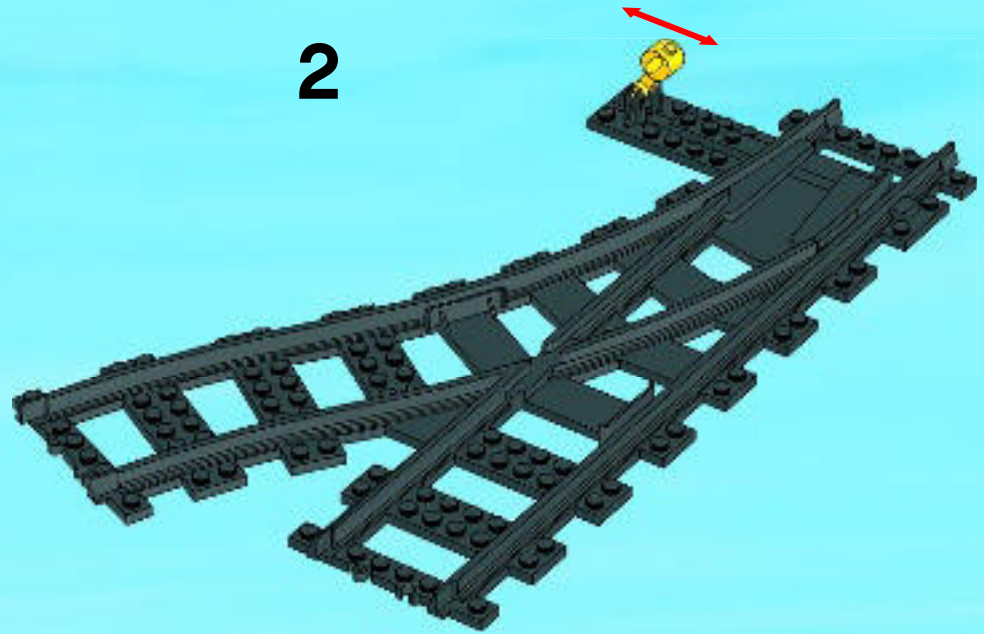

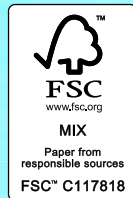
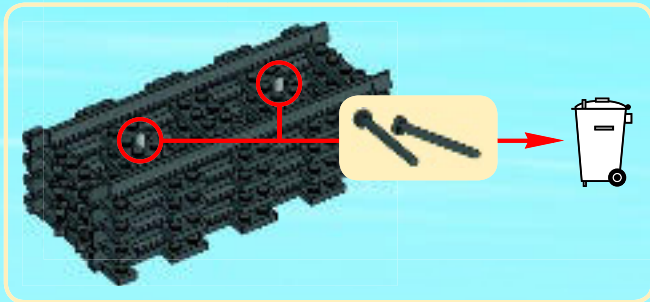
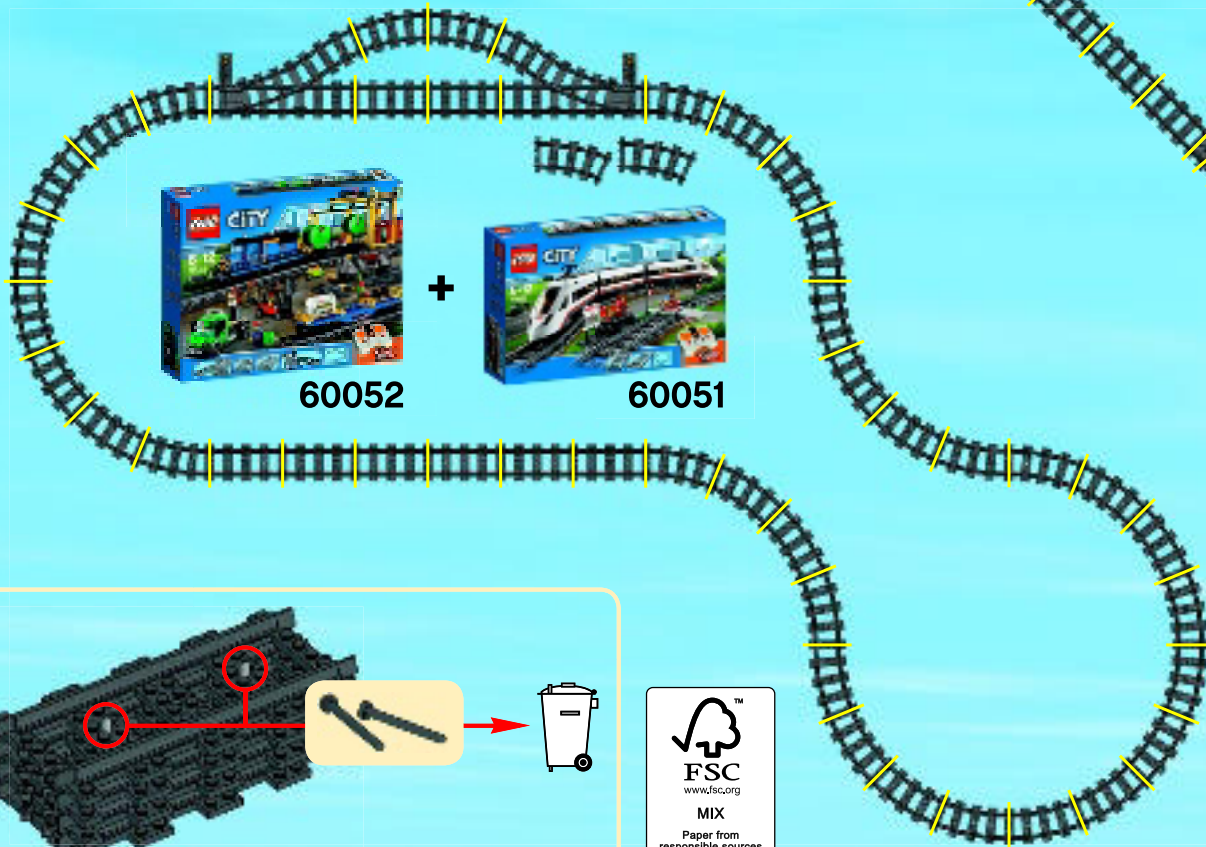

Train trouble-shooting guide
 Anleitung zur Fehlerbehebung bei Zügen
 Guide de dépannage du train
 Guía de solución de problemas ferroviarios
 Guia de resolução de problemas do comboio
 Vasúti javítási útmutató
 列车故障指南
LEGO.com/city



CITY

60052



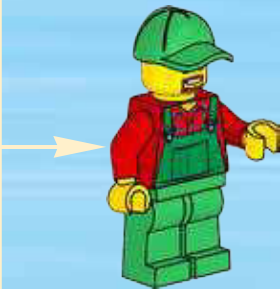
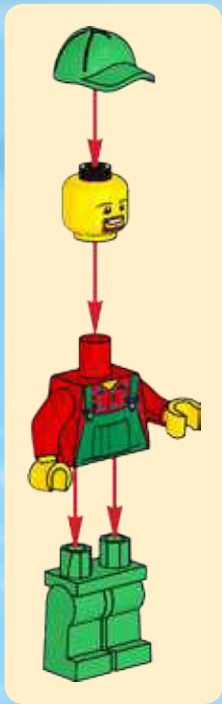
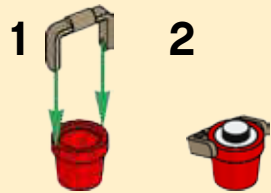
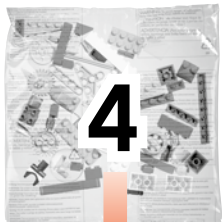
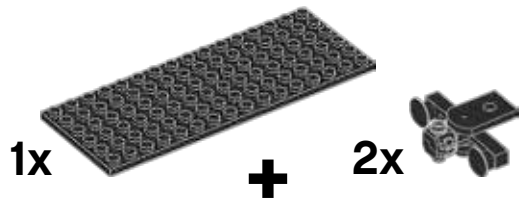

1



2



3

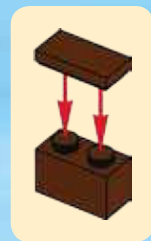

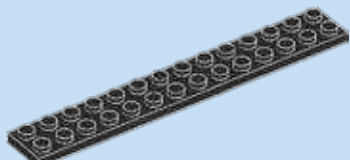

1x

1

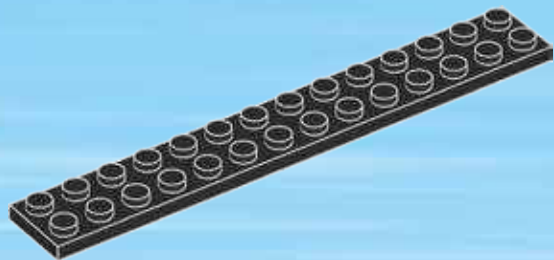



5x

2

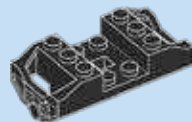
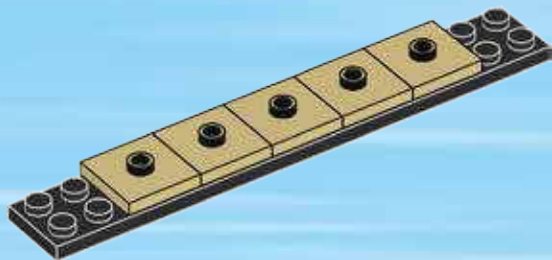

2x

3

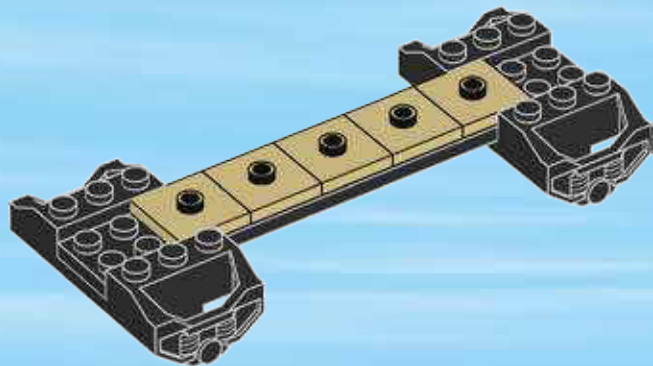

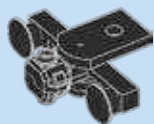

2x

4

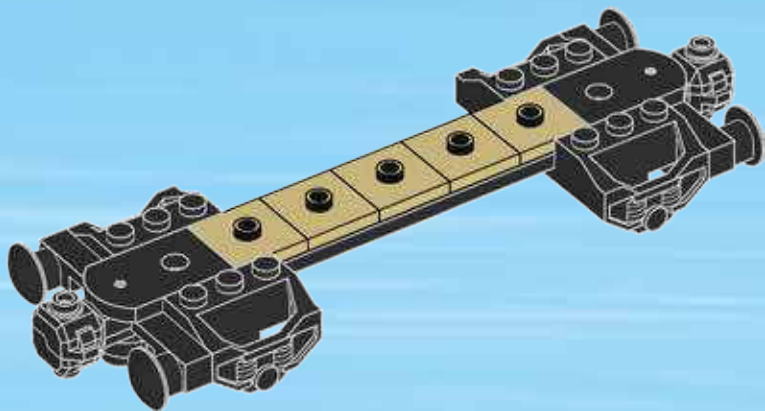

6

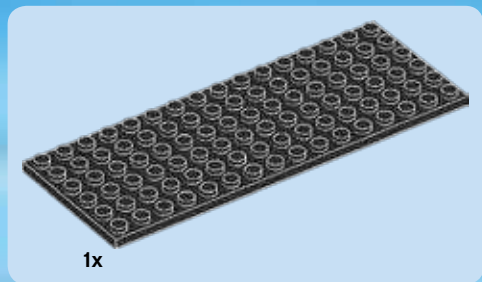

5

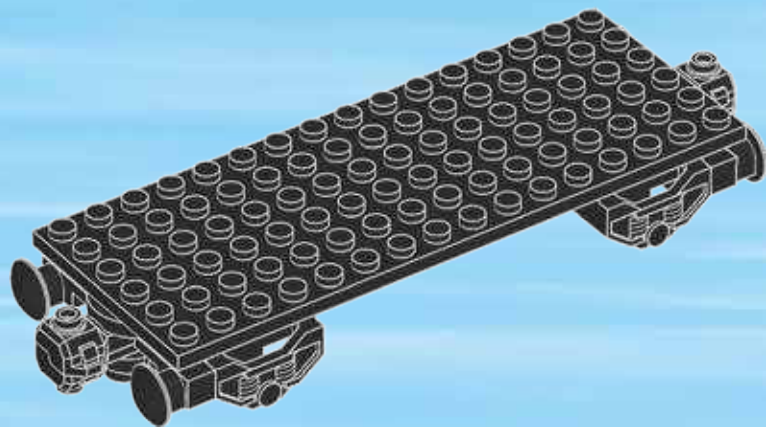



10x

6

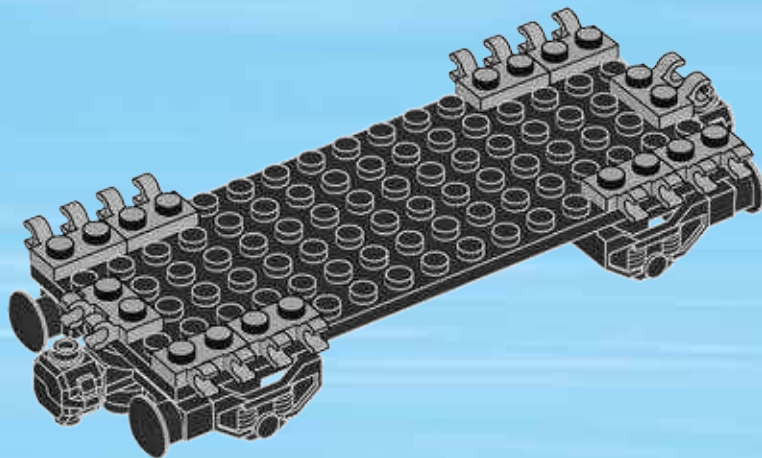

8



3x

7

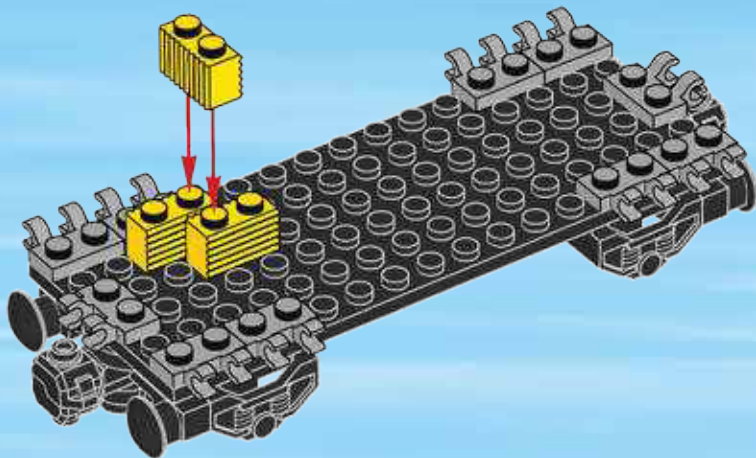

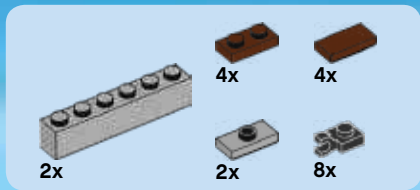

8

1

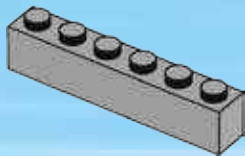

2

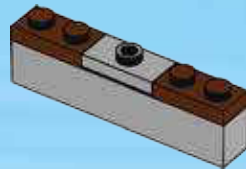

3

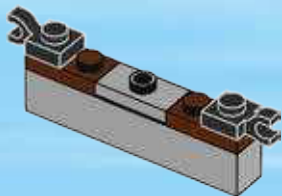

4

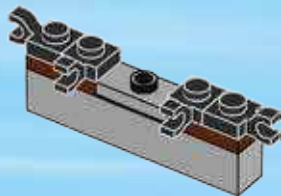

5

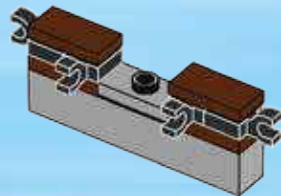

2x

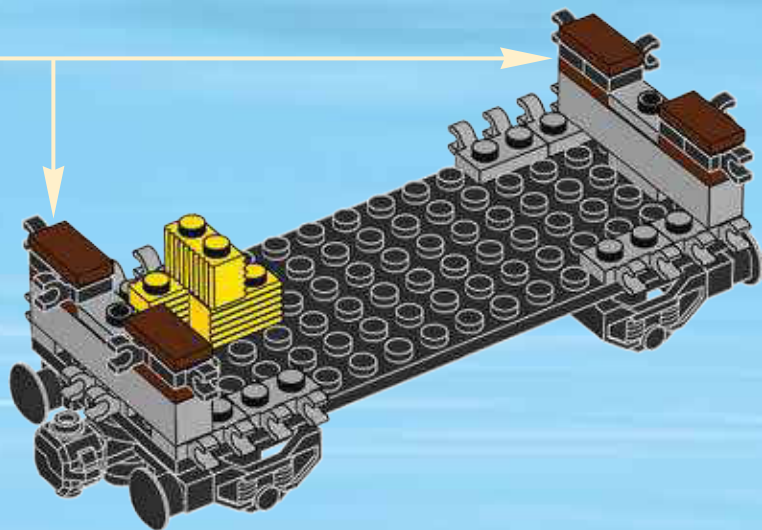



4x

9

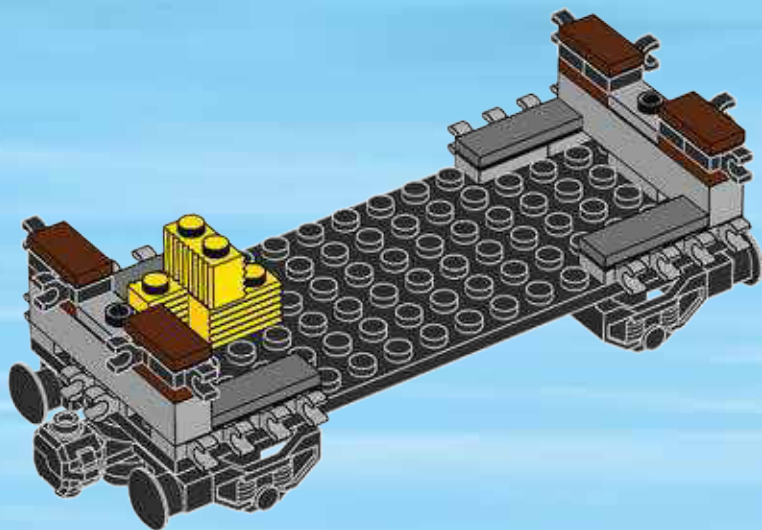



2x



2x

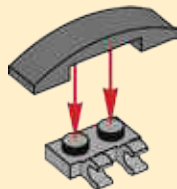

2x

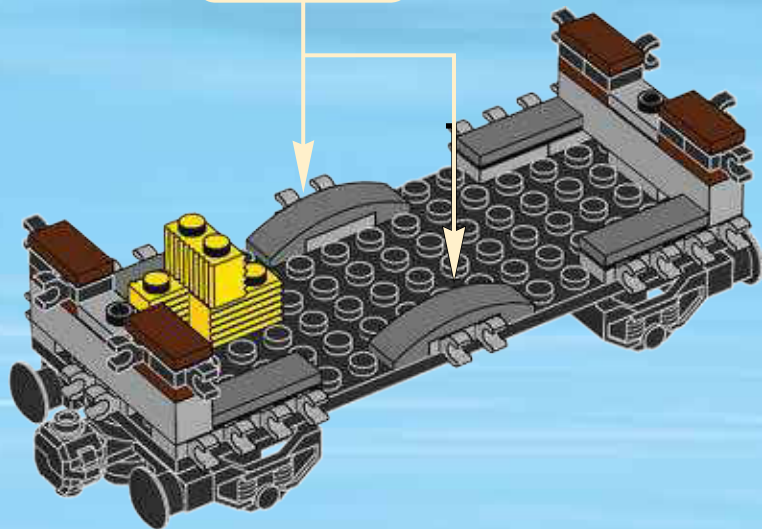

10

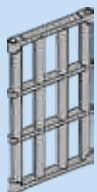

2x

11

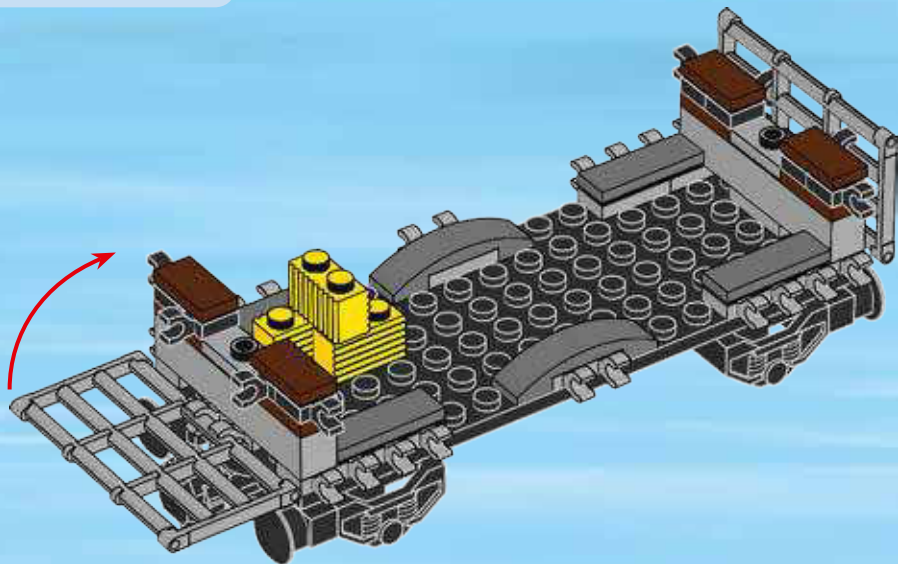



4x

12

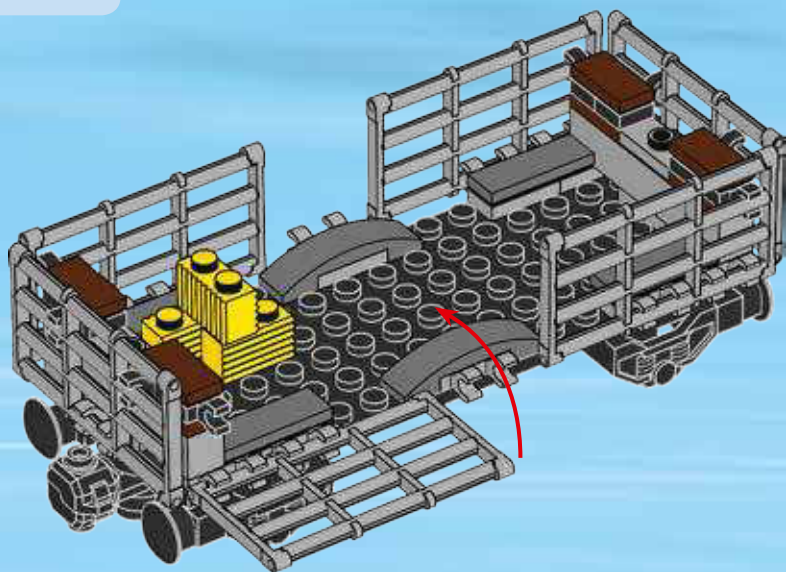



13

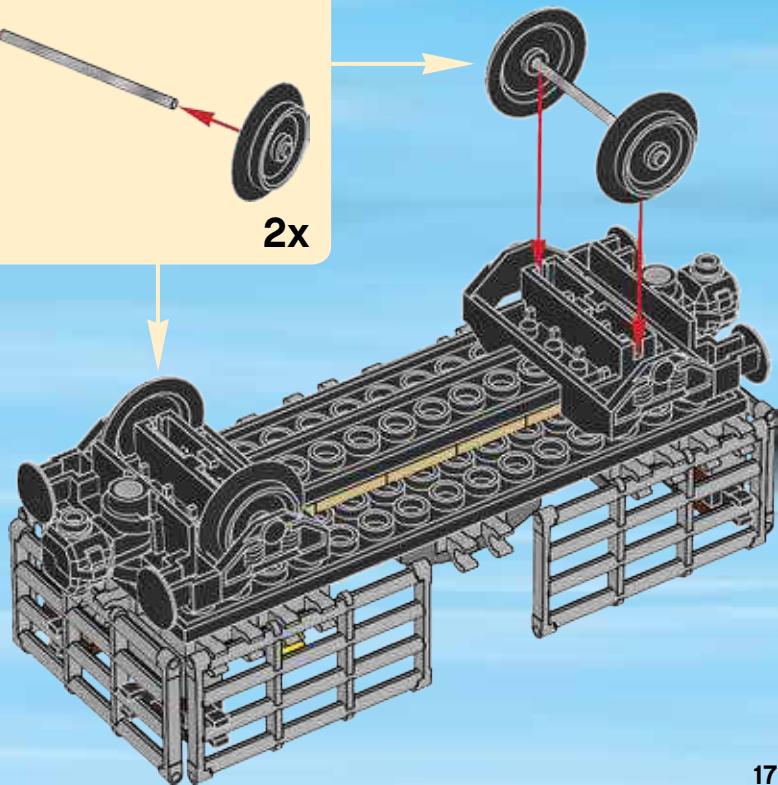
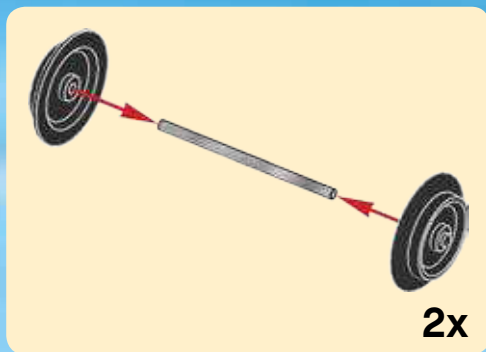



1x



2x



14

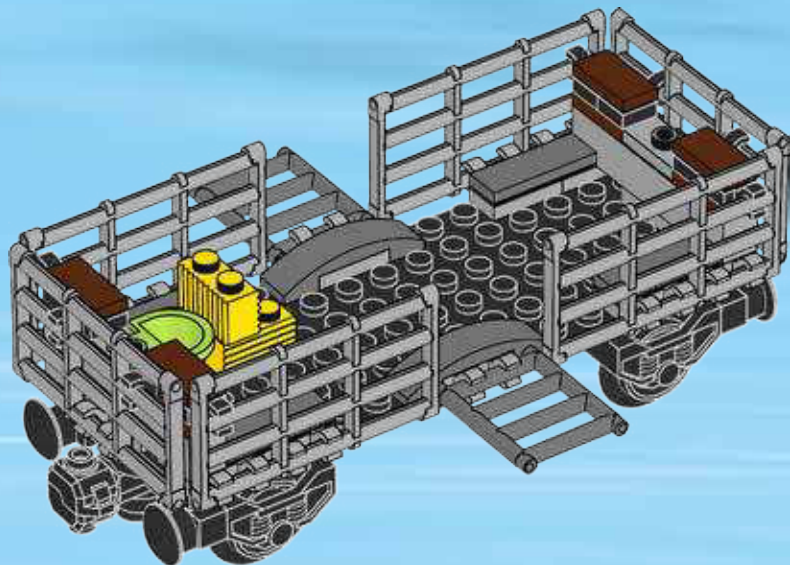

15

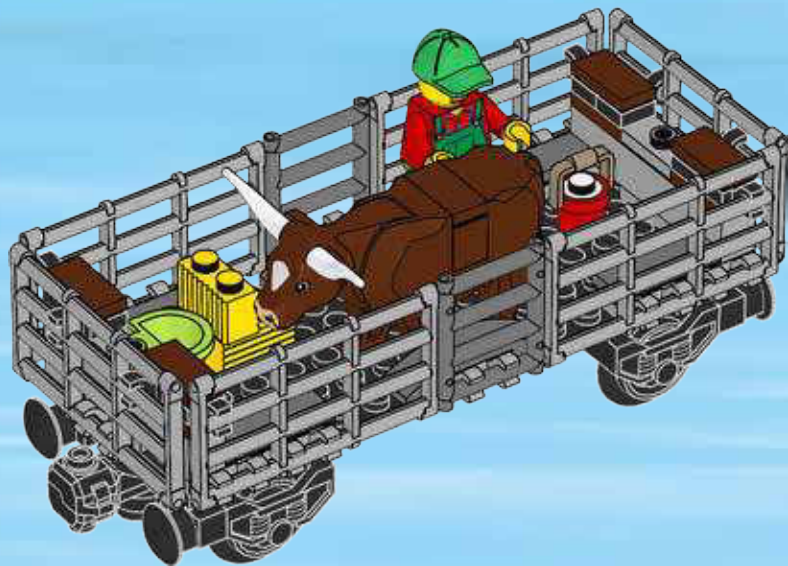

**DOWNLOAD THE
FREE LEGO® CITY
MY CITY 2 APP**



Ask parents'
permission first

Bitte frage erst deine Eltern um
Erlaubnis • Demande d'abord
l'autorisation d'un parent • Pide antes
permiso a tus padres • Pede primeiro
permissão aos teus pais • Először
kérdj engedélyt a szüleidtől!
先请求家长的许可。



Lade dir die kostenlose App LEGO® City My City 2 herunter • Télécharge l'application
gratuite LEGO® City My City 2 • Descarga gratis la app LEGO® City My City 2 • Descarrega
a app grátis LEGO® City My City 2 • Töltsd le ingyenesen a LEGO® City My City 2 appot!

下载免费乐高®城市我的城市应用程序 2.0 版本

Apple and the Apple logo are trademarks of Apple Inc.,
registered in the U.S. and other countries. App Store is a service mark of Apple Inc.

Google Play is a trademark of Google Inc.

LEGO and the LEGO logo are trademarks of the LEGO Group.

©2014, 2016, 2017 The LEGO Group. 6201474



CITY

60052

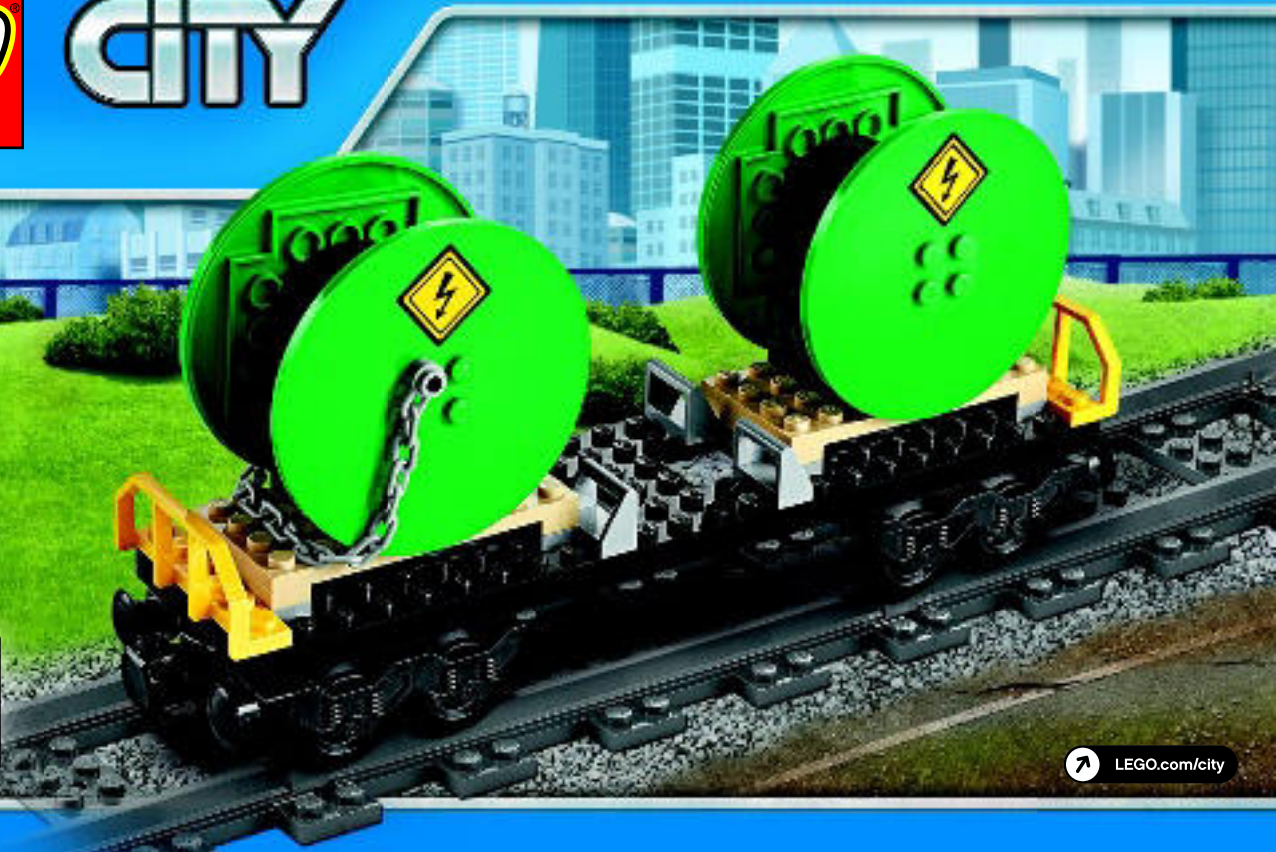

2x



1x



+

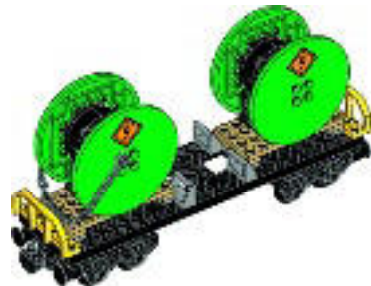

1

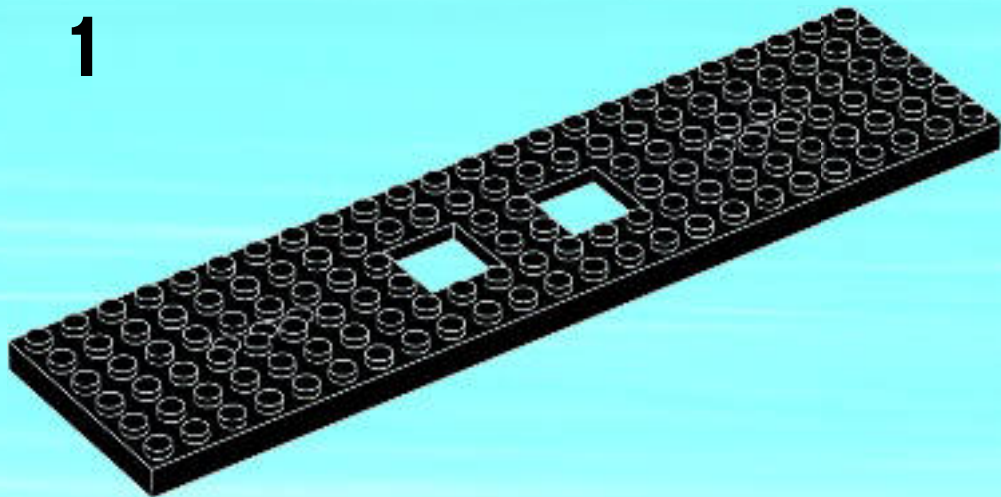

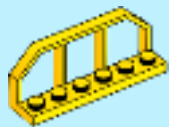

2x

2

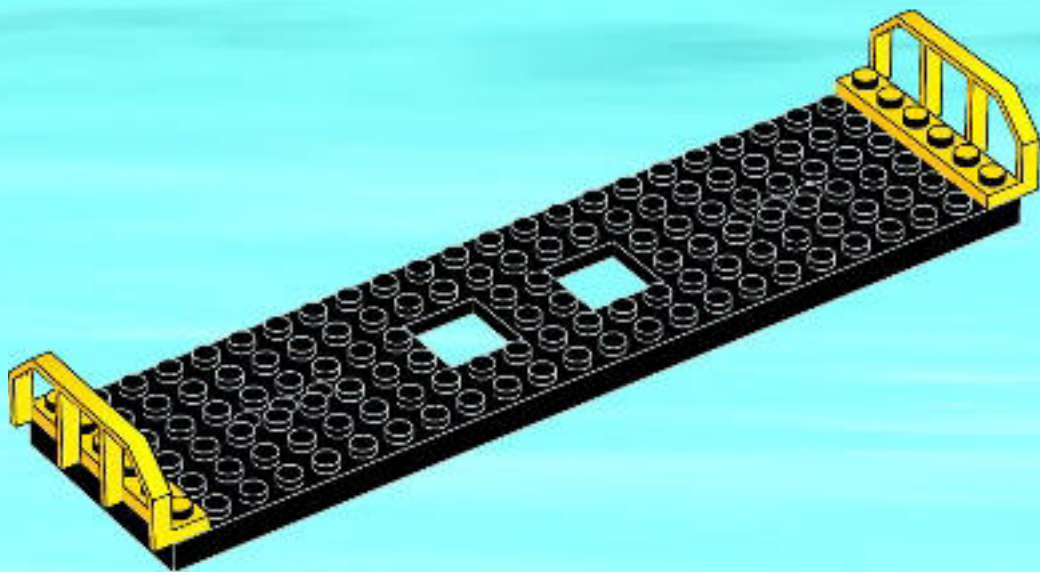



4x

3



4



4x

4

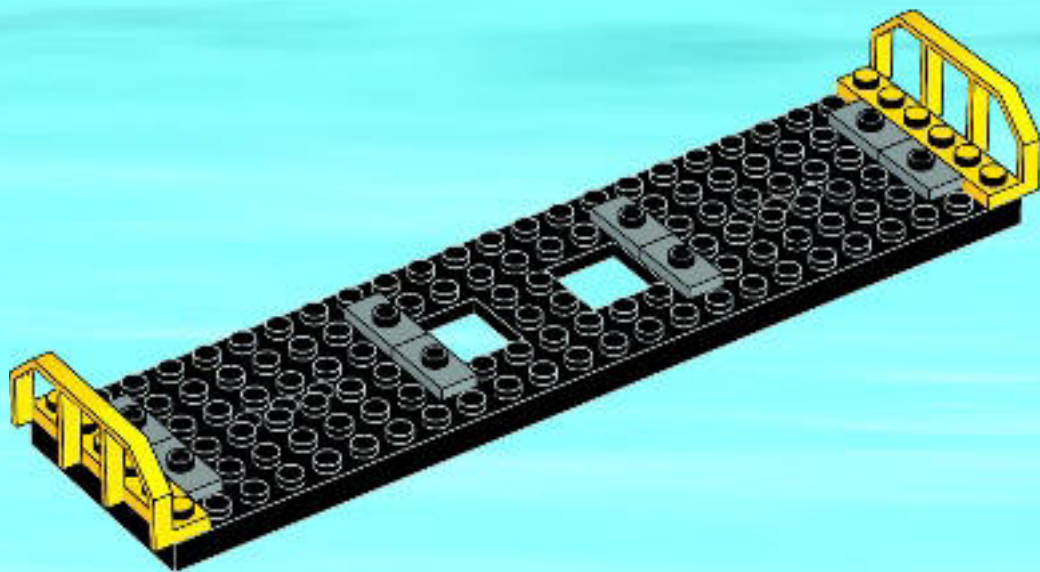



4x

5

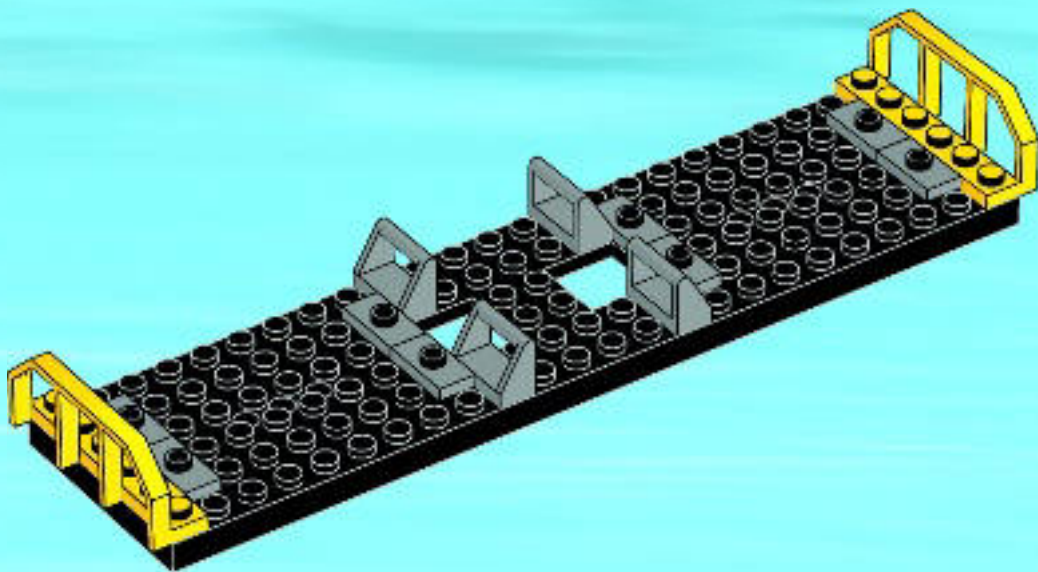

6



4x

6

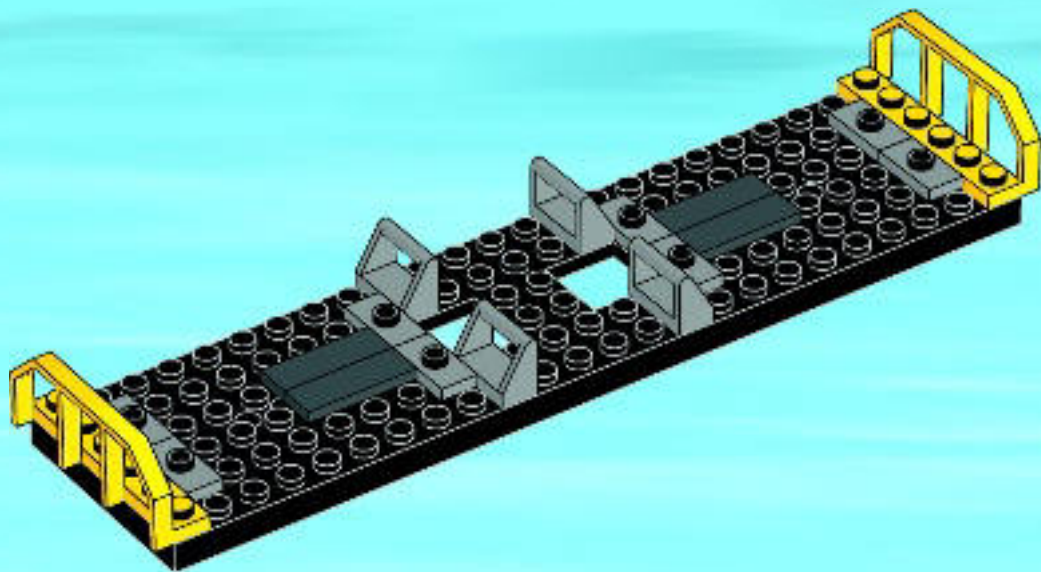

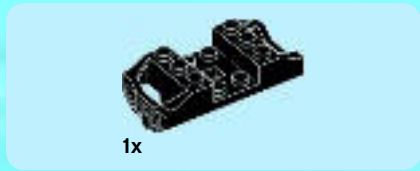

1x

1

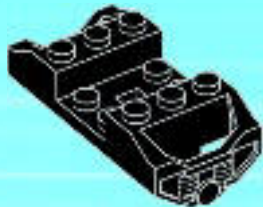

1x

2

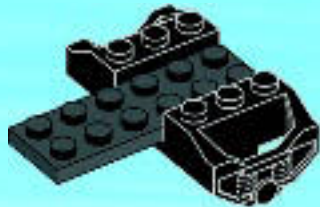



1x

3

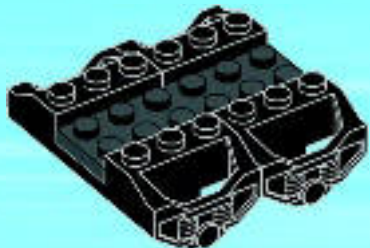

1x



1x

4





2x



4x

5

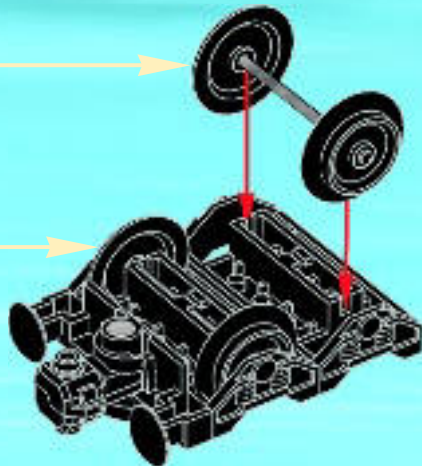
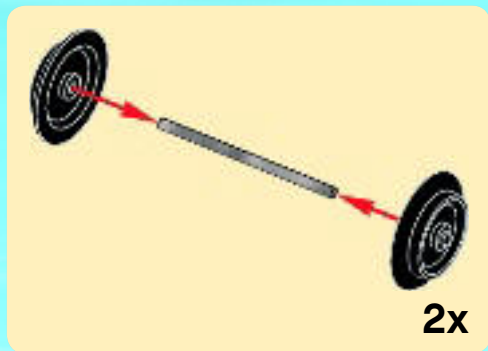

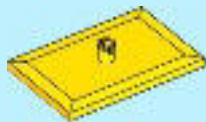

1x

6

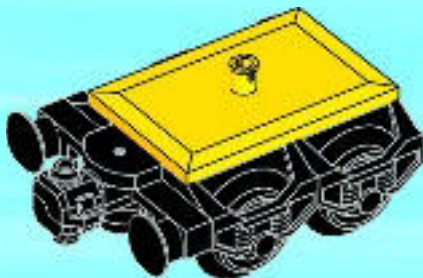

2x

7

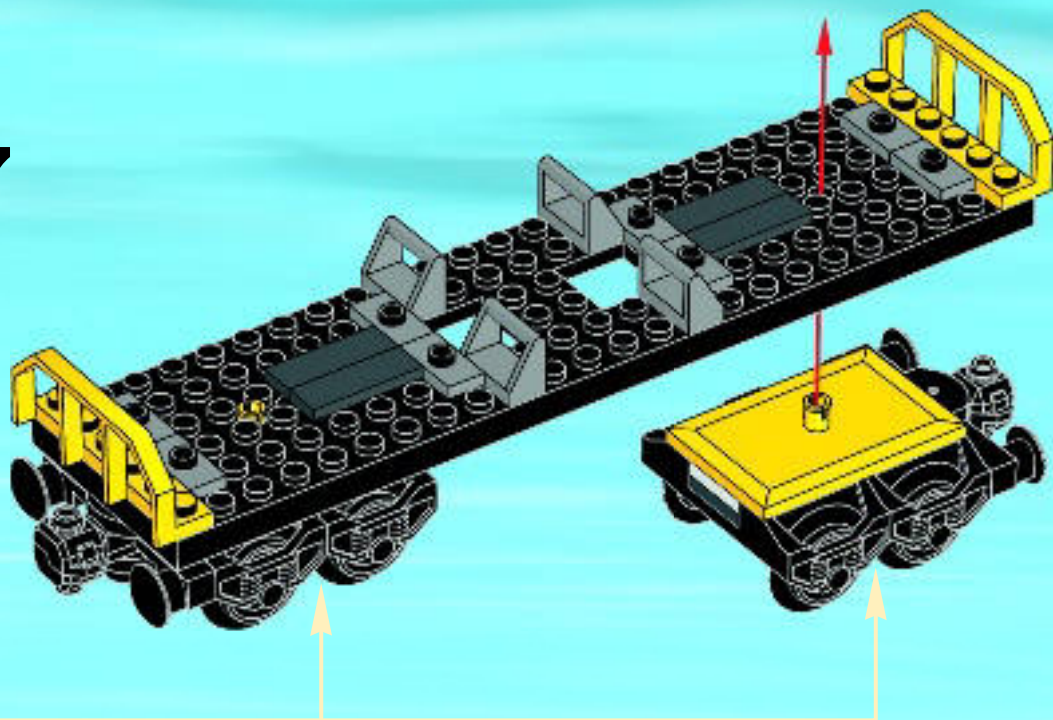

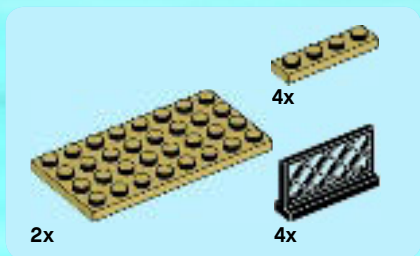

8

1

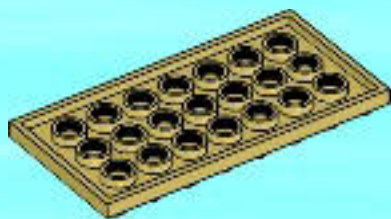

2

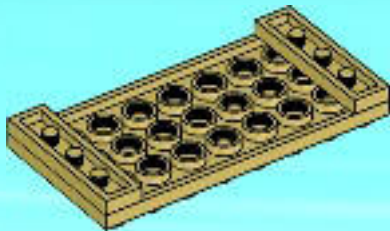

3

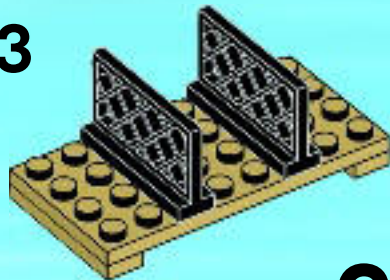

2x

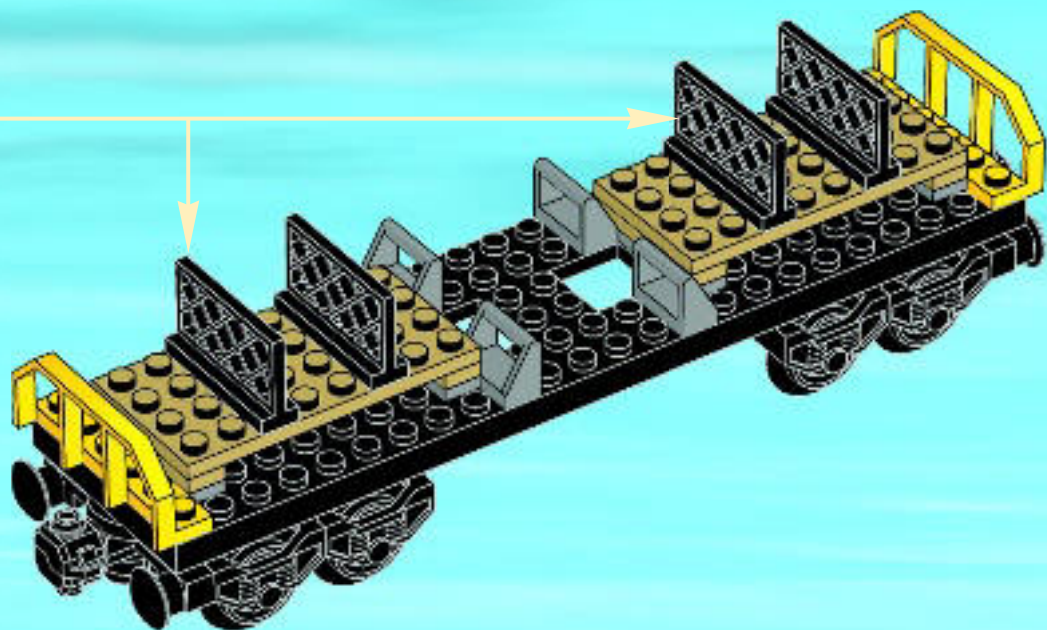



1

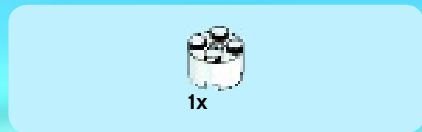

2





2x

3

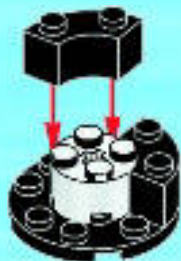

2x

4





1x

5



1x

6





1x

7

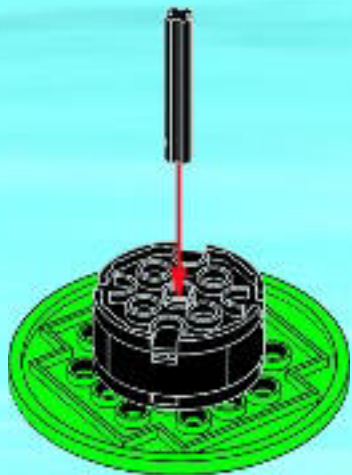

8

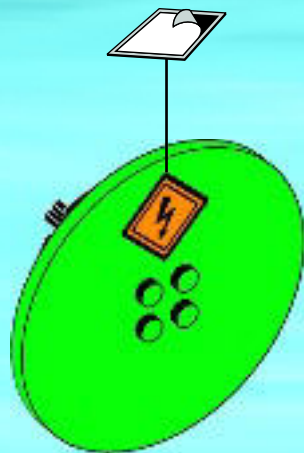

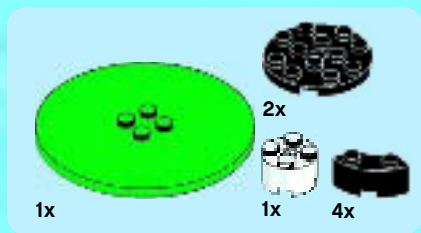
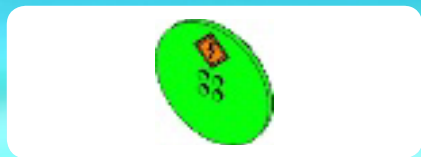

9

1



2



3



4



5

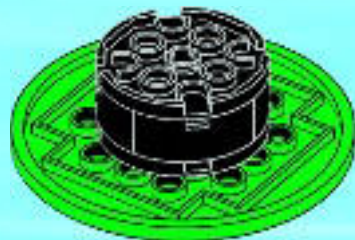



6

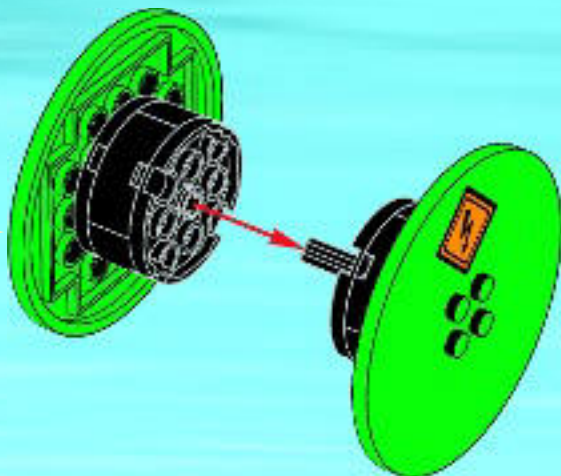
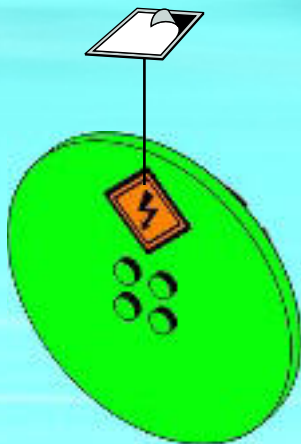

2x

9

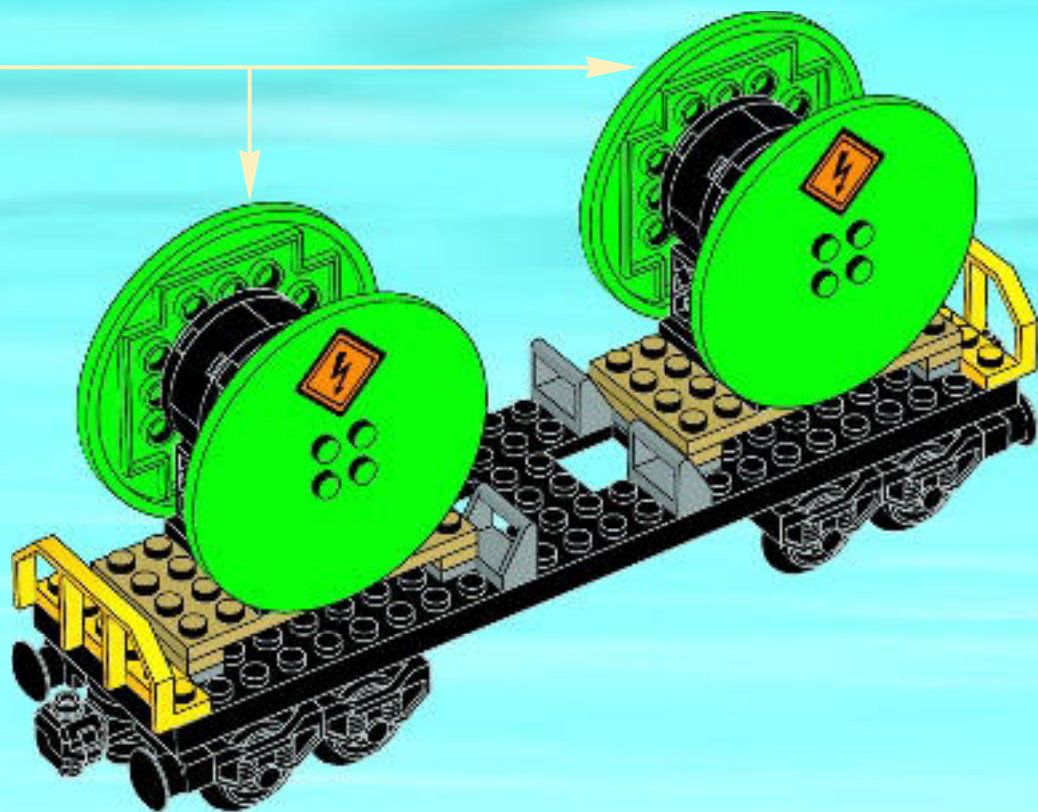



10

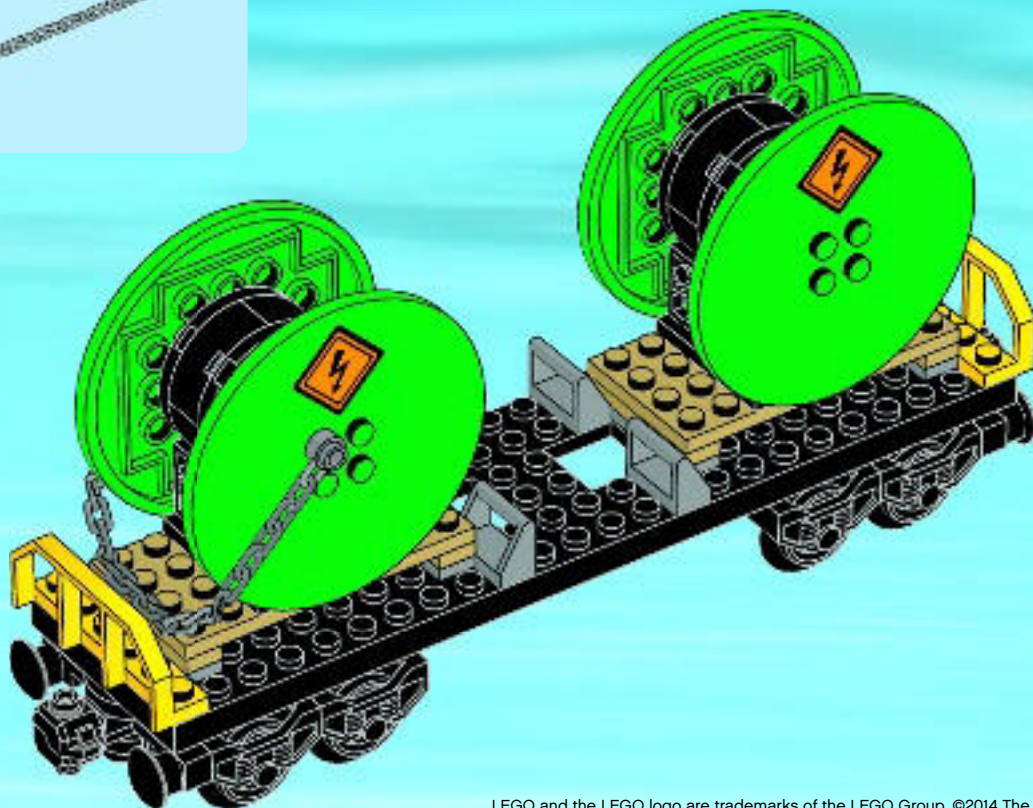





CITY

60052

5



1x  + 2x 

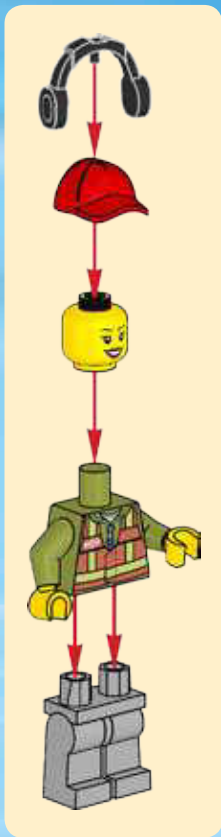
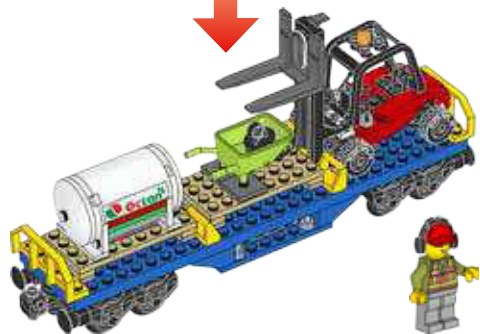

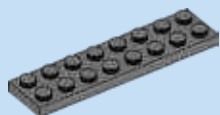

1x

1

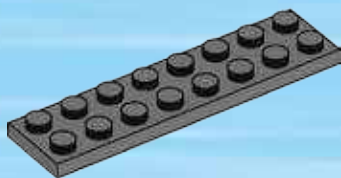

2x

2

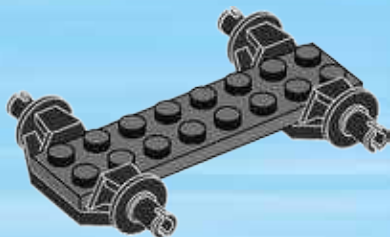

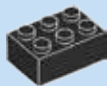

1x

3

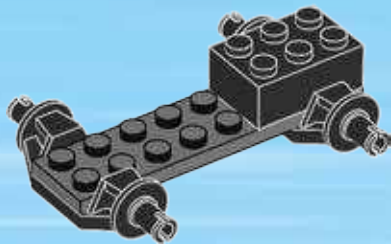

4



2x



1x

4

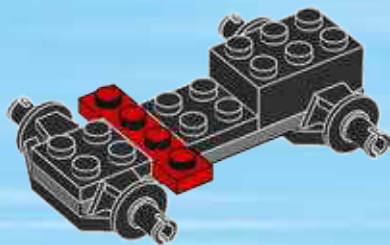

1x



1x



2x

5

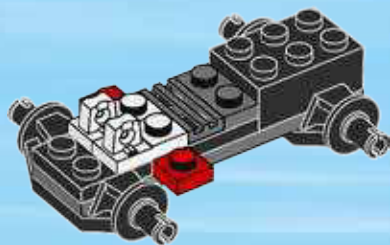



1x

6

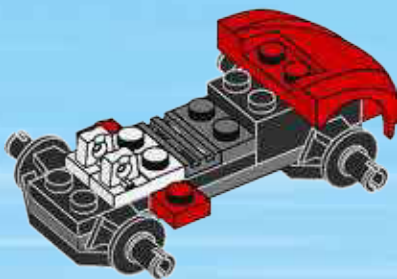



2x

7

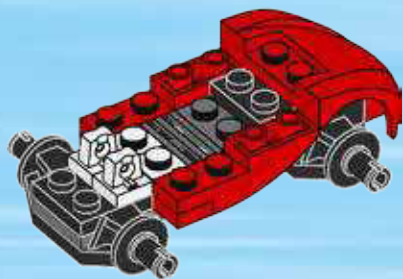

2x

8

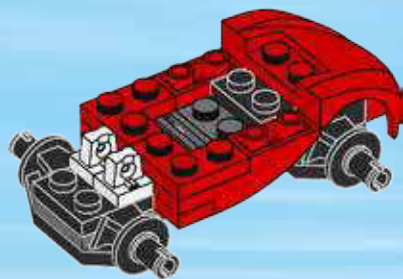



1x

9

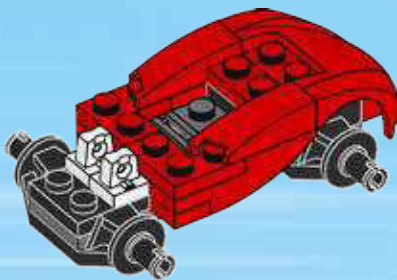

8



1x



2x

10

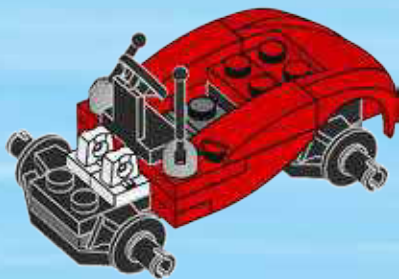

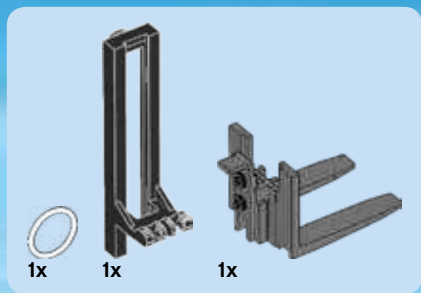

11

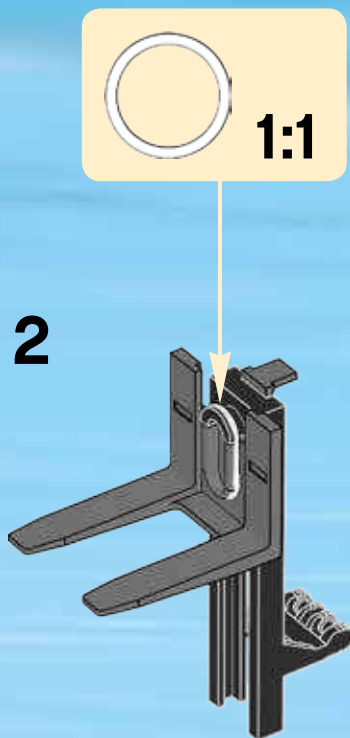
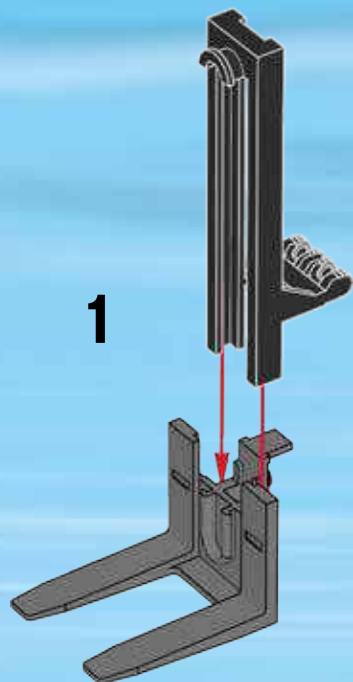



2x

12

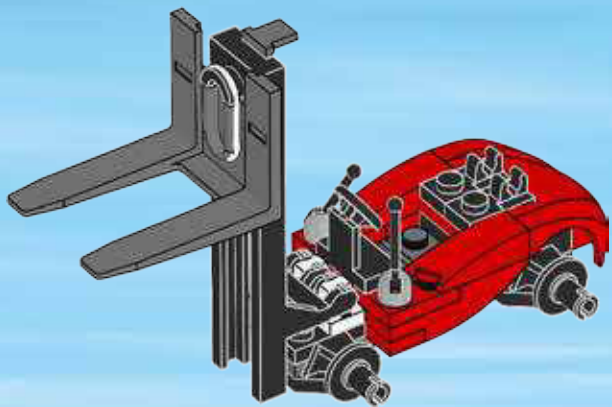
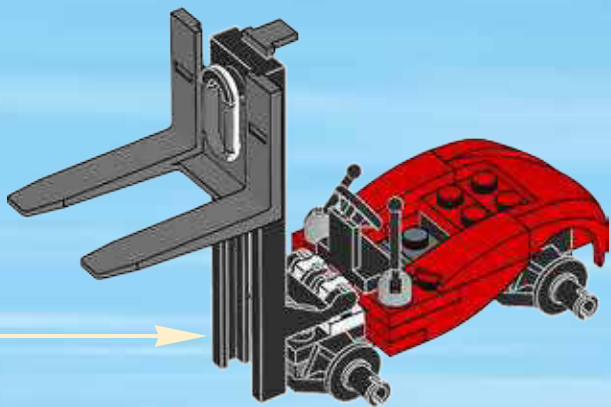

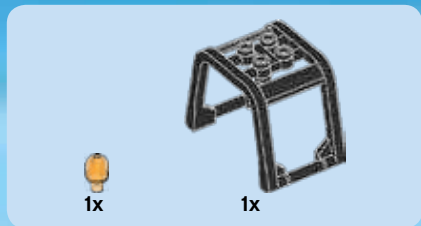

13

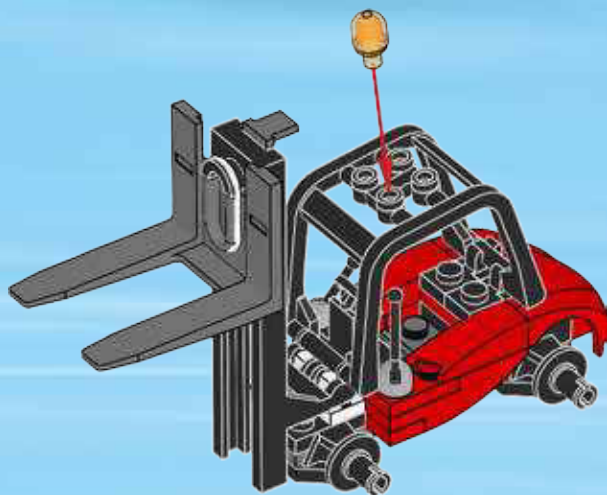



4x



4x

14



4x

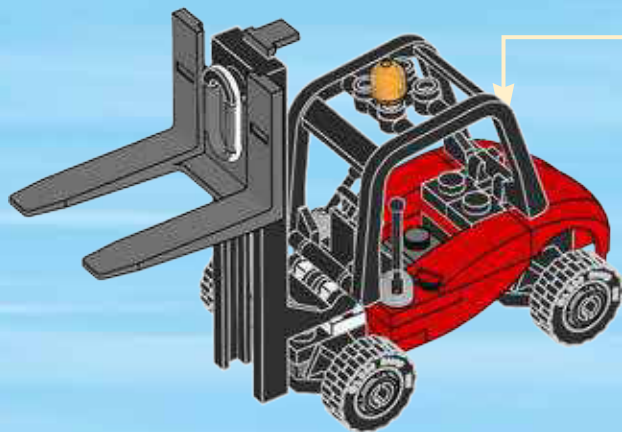

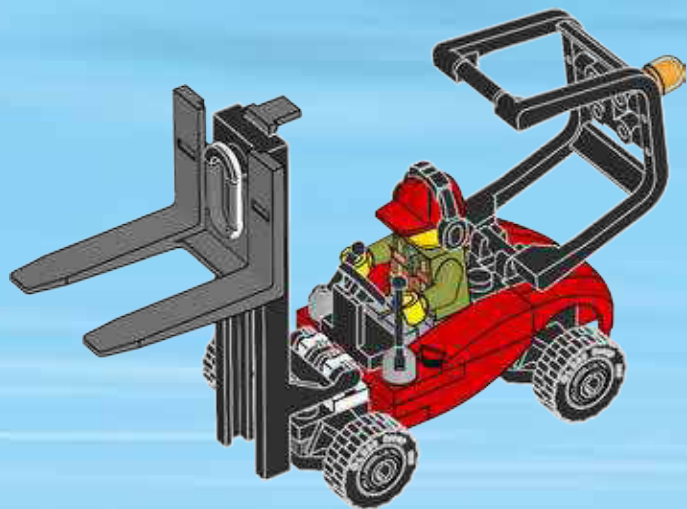



1x

1



2x

2

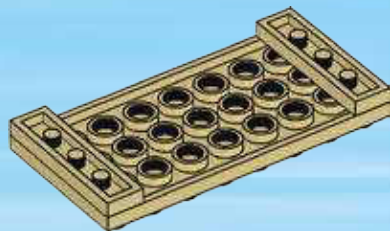



2x

3

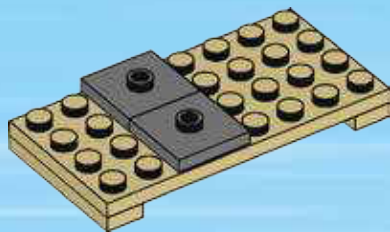



4

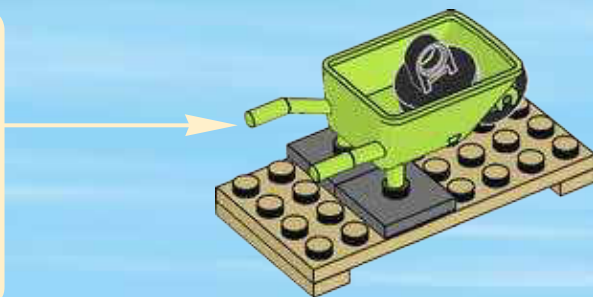
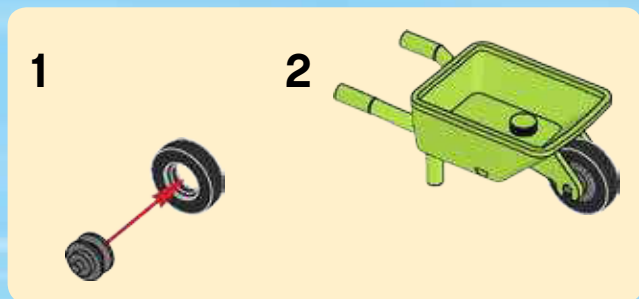

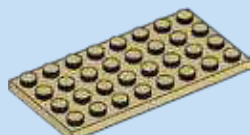

1x

1

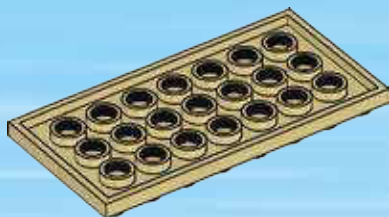



2x

2

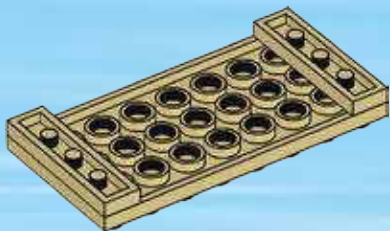

2x



2x

3

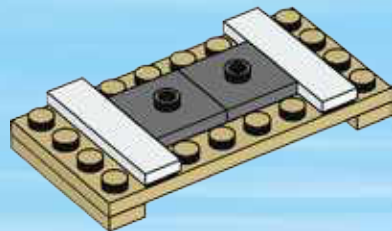



1x

4

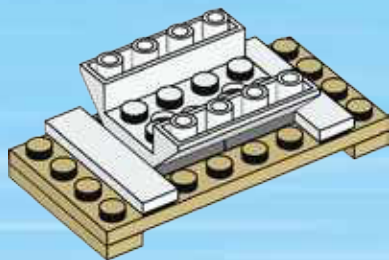



2x



2x

5

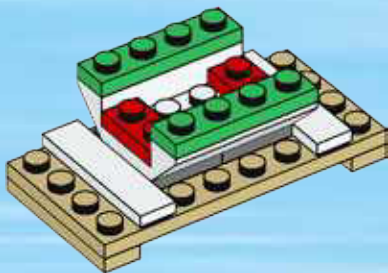

2x

6

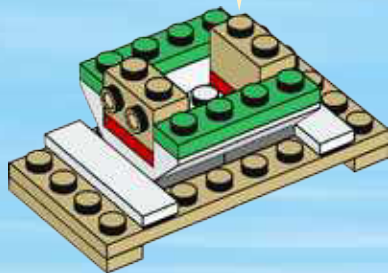
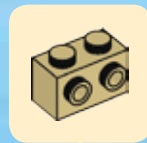



2x

7

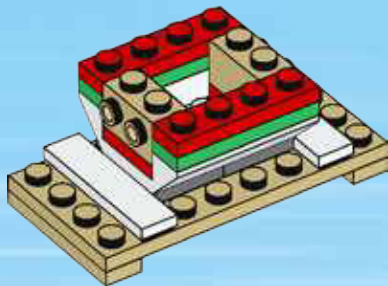

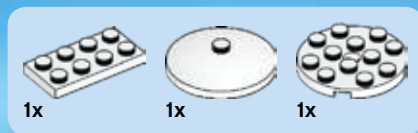

8

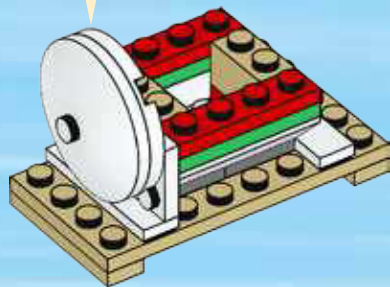

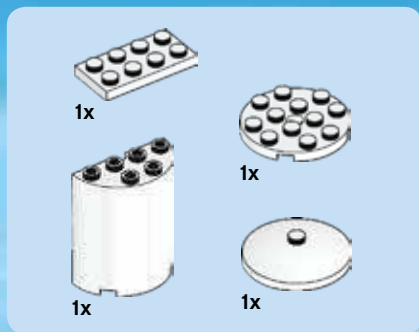

9

1



2



3





4



5

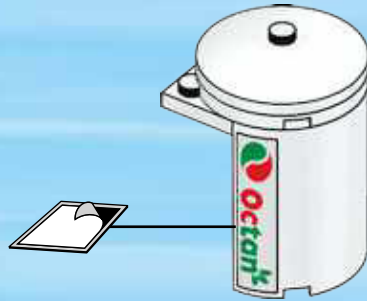

6





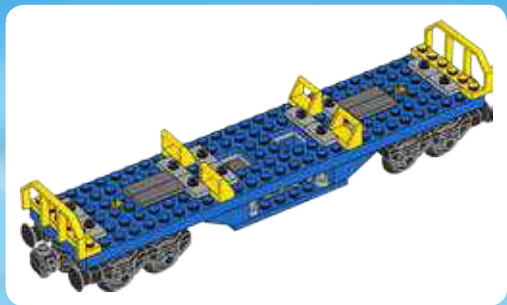

1



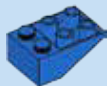

4x

2

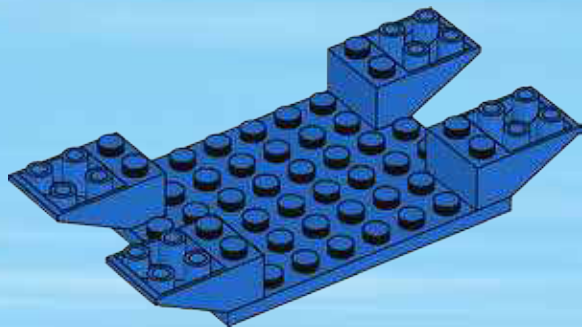



3

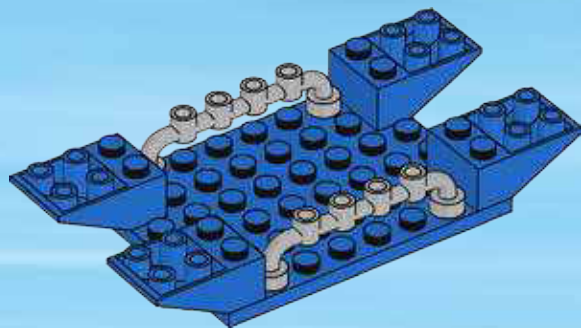



1x

4

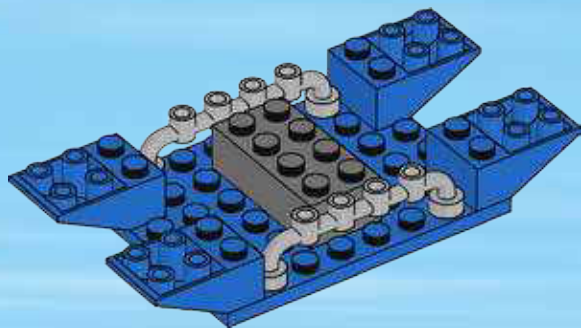

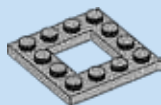

2x

5

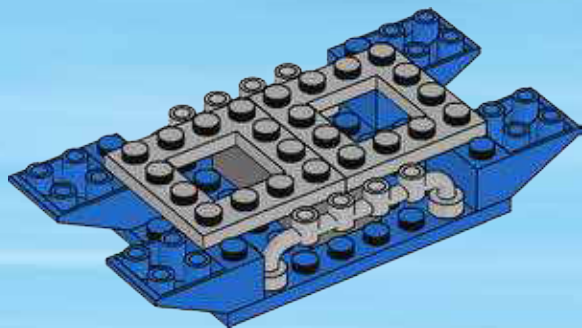

6

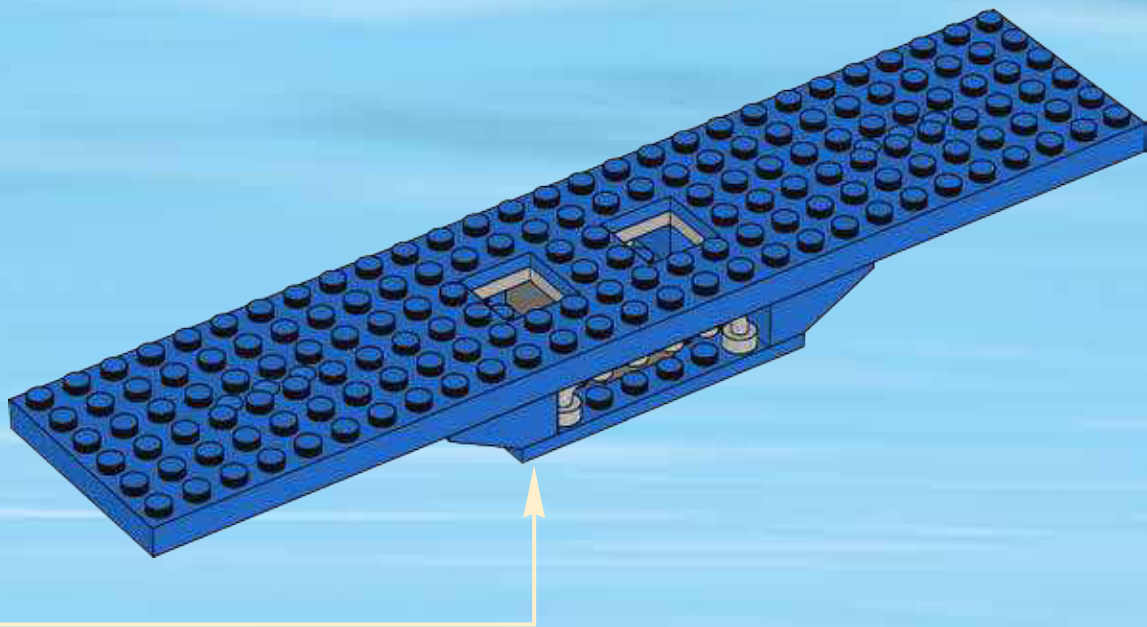



4x

7

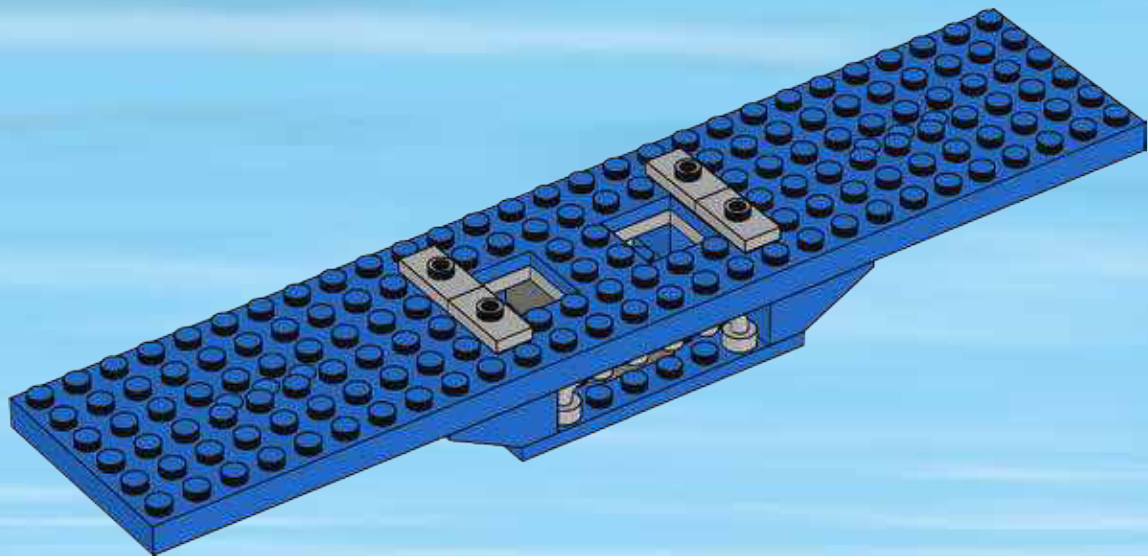



4x

8

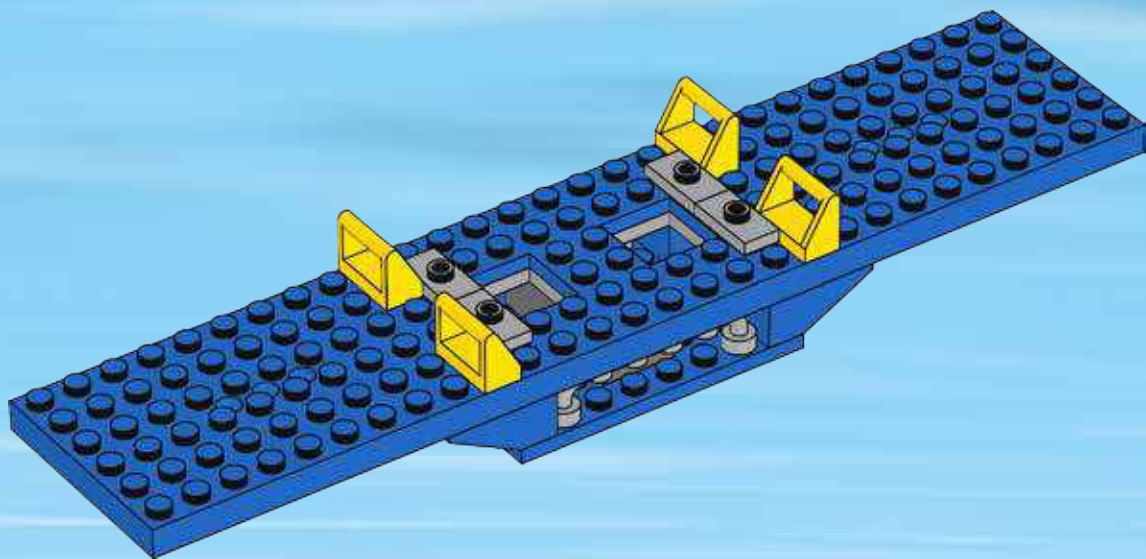



4x

9

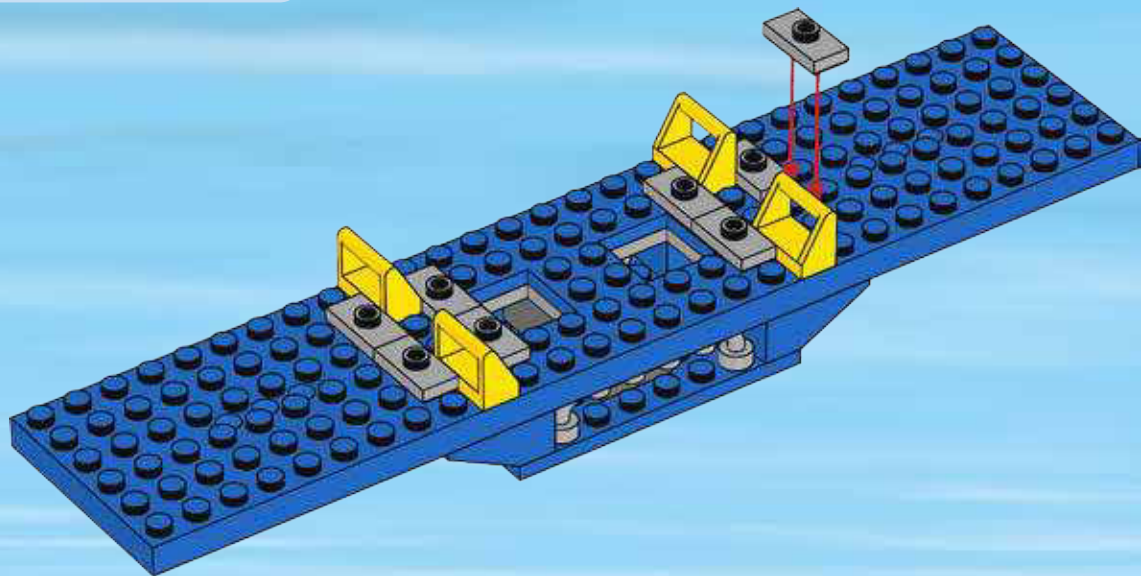



4x

10

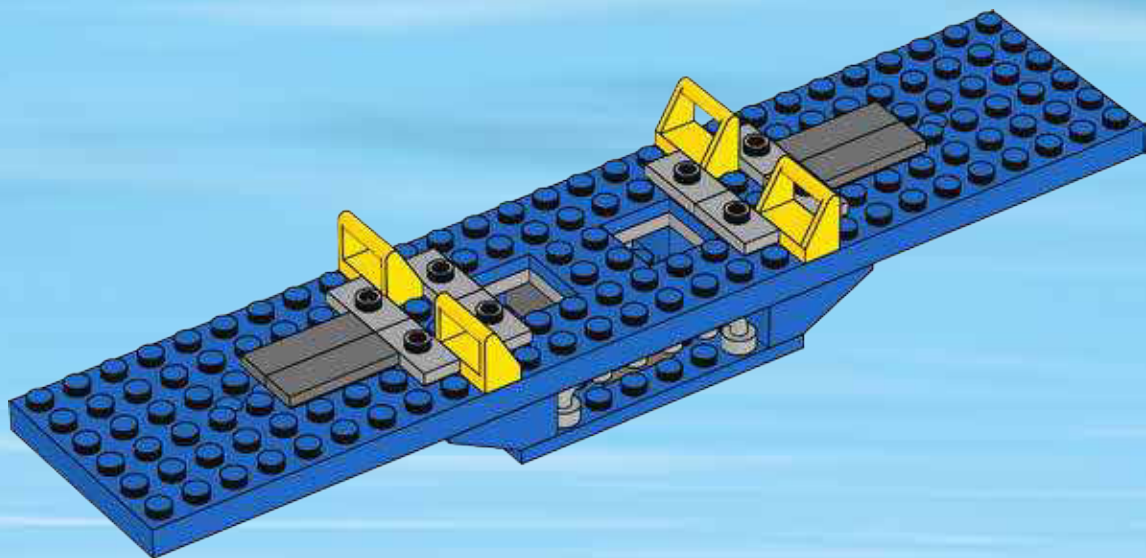

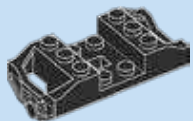
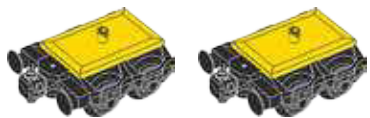

1x

1

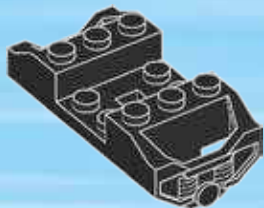

1x

2

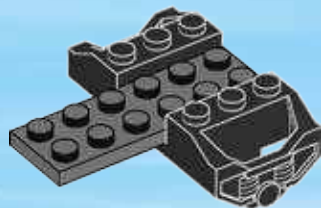

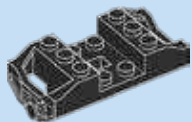

1x

3

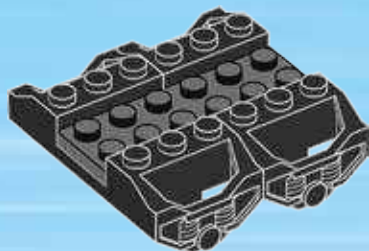



1x



1x

4

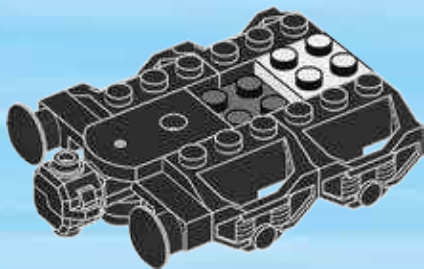

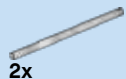

2x



4x

5

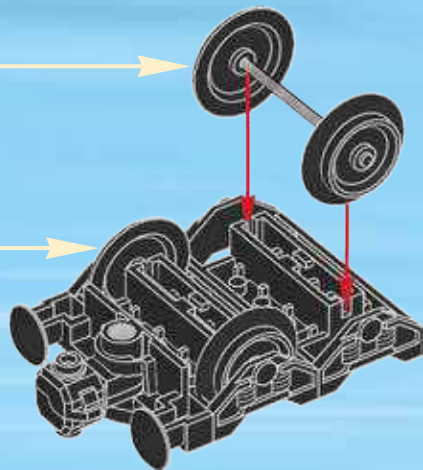
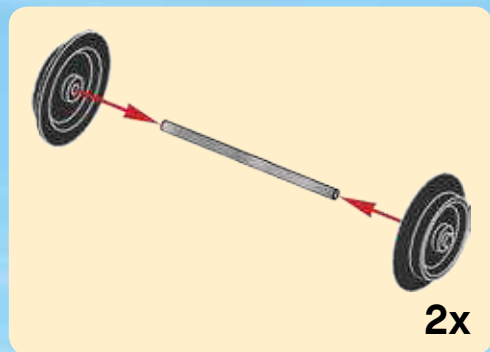



1x

6

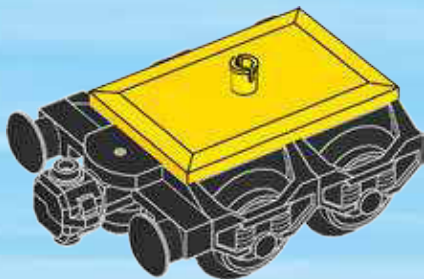

2x

11

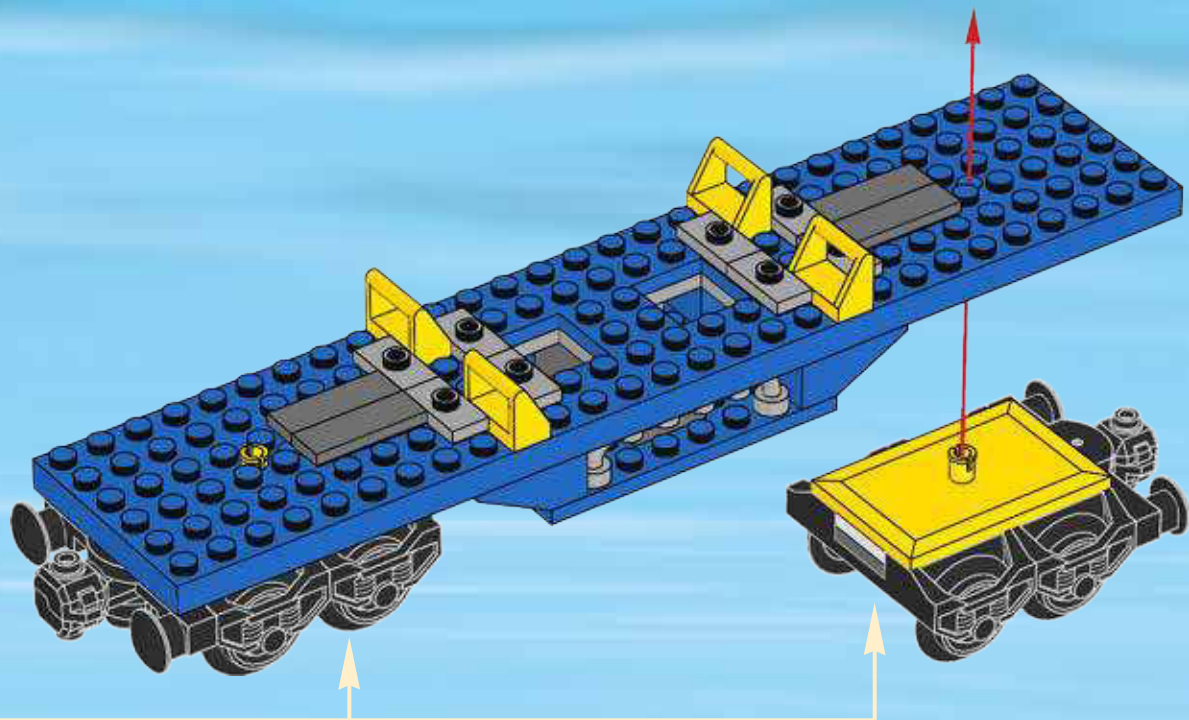



4x

12

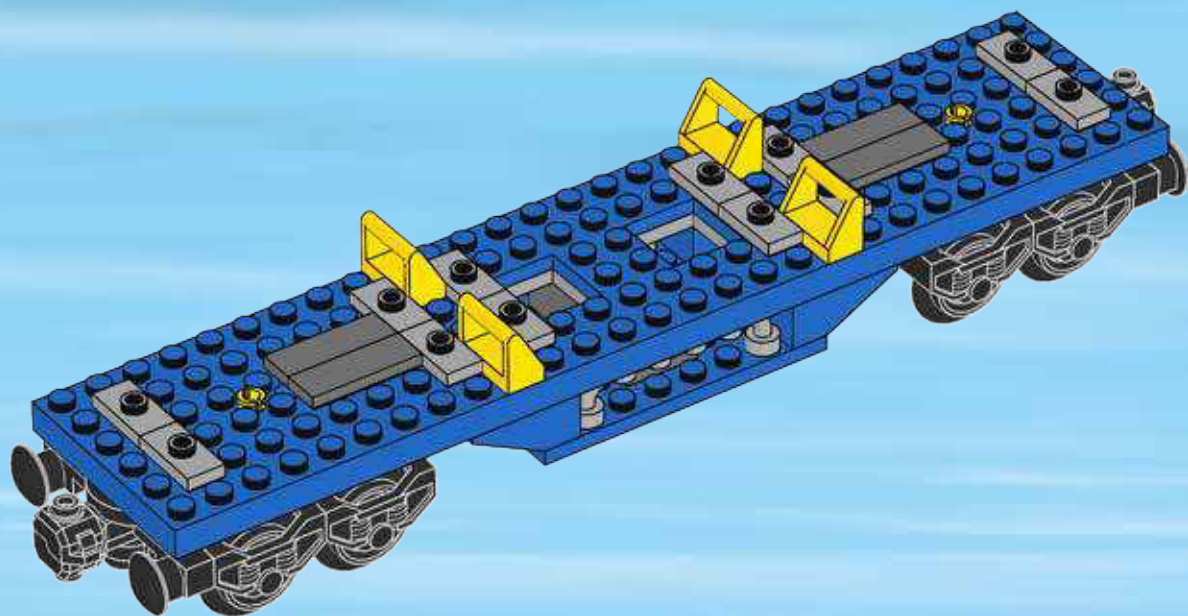

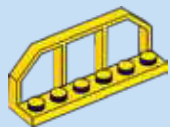

2x

13

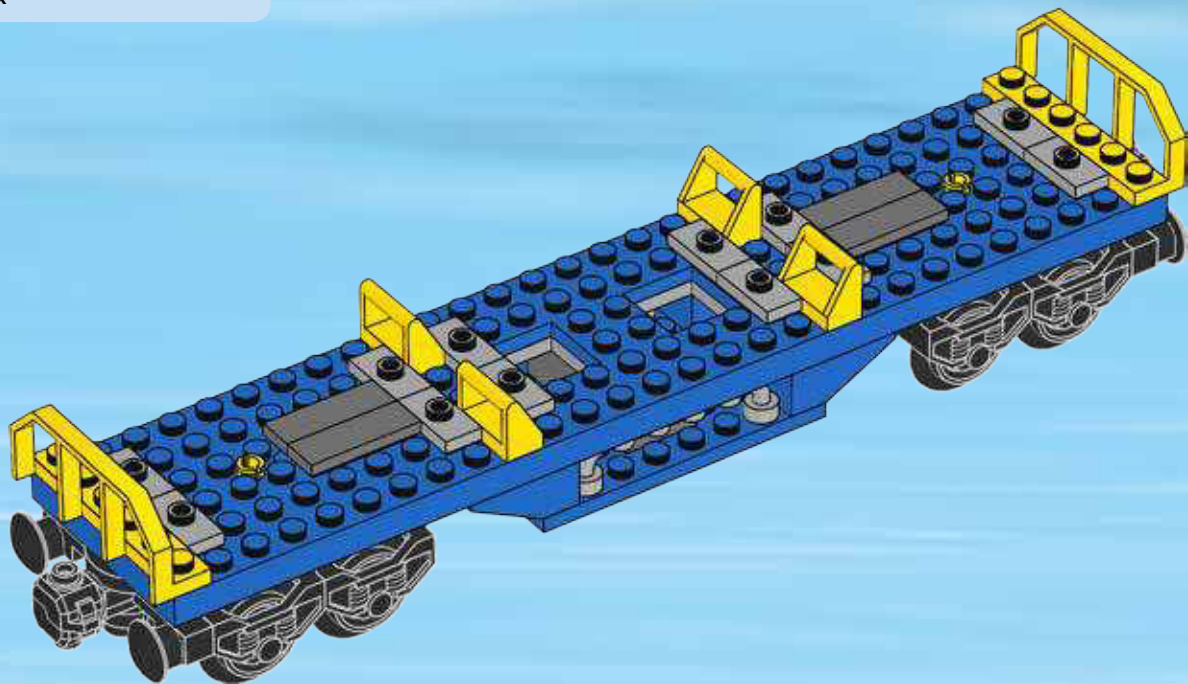



LEGO**CITY**

60144



60147



60148



60149



60146



60145



60152



60119



60150



60117



LEGO.com/city

LEGO CITY



60141

60140

60139

60138

60137

60136

60135

 [LEGO.com/city](https://www.LEGO.com/city)



CITY



60051



60052

LEGO and the LEGO logo
are trademarks of the LEGO Group.
©2014, 2016, 2017 The LEGO Group. 6201478

LEGO.COM/CITY



CITY

60052



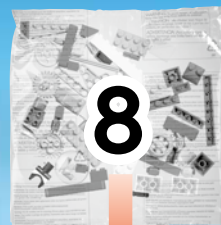
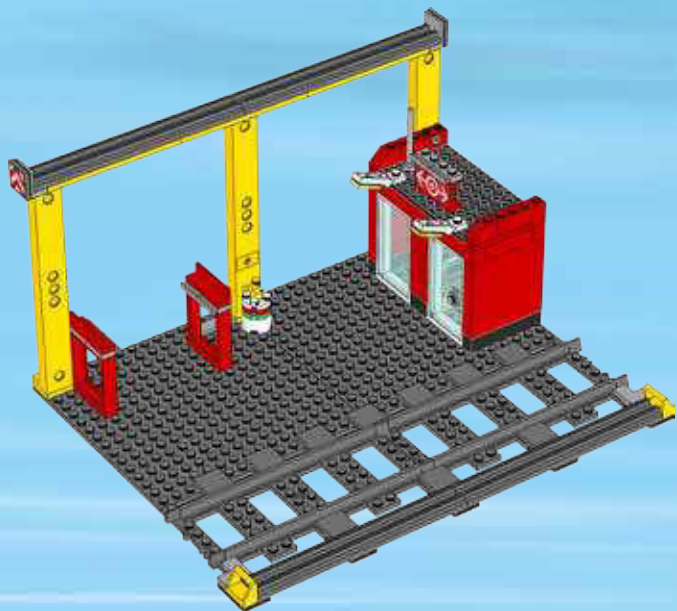

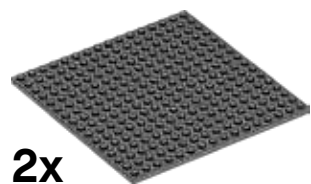

2x



2x



3x

+



7

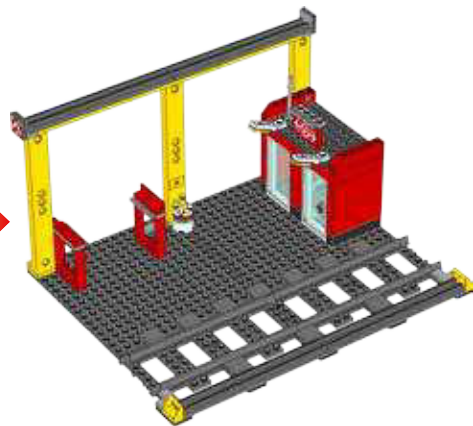

1x

1

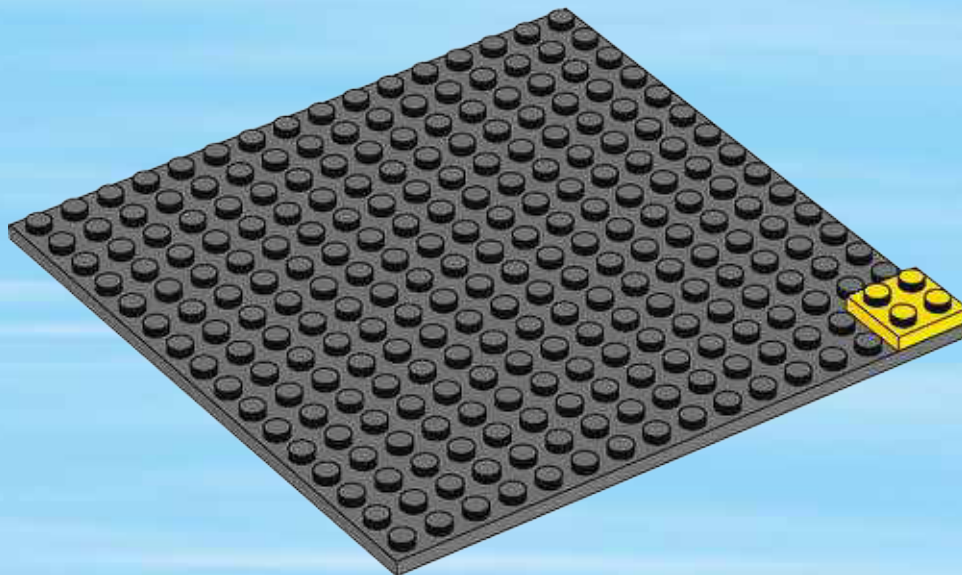

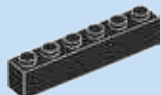

1x

2

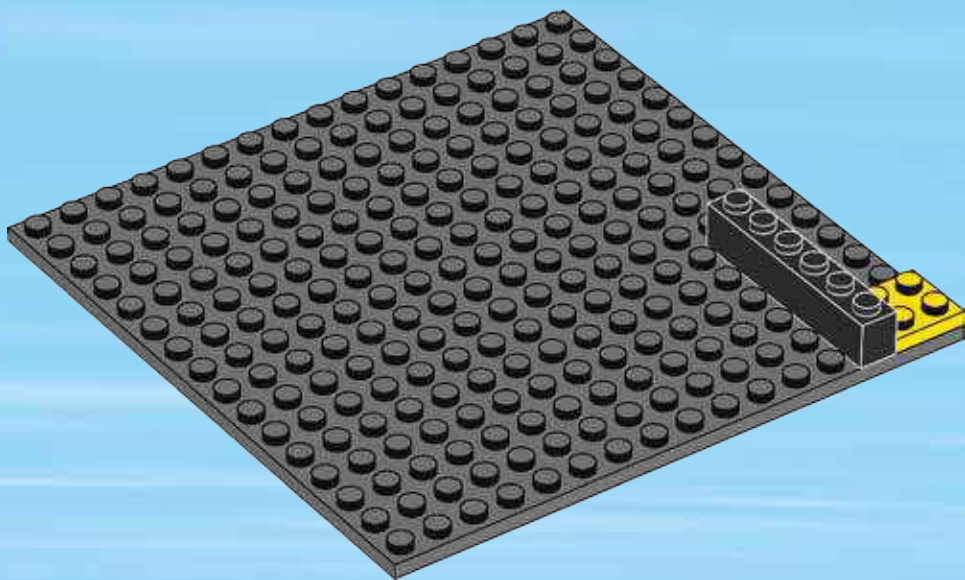

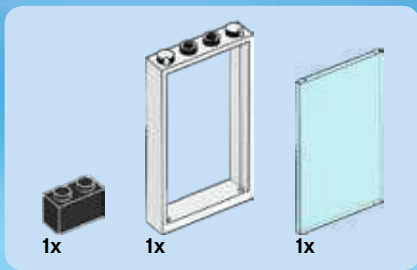

3

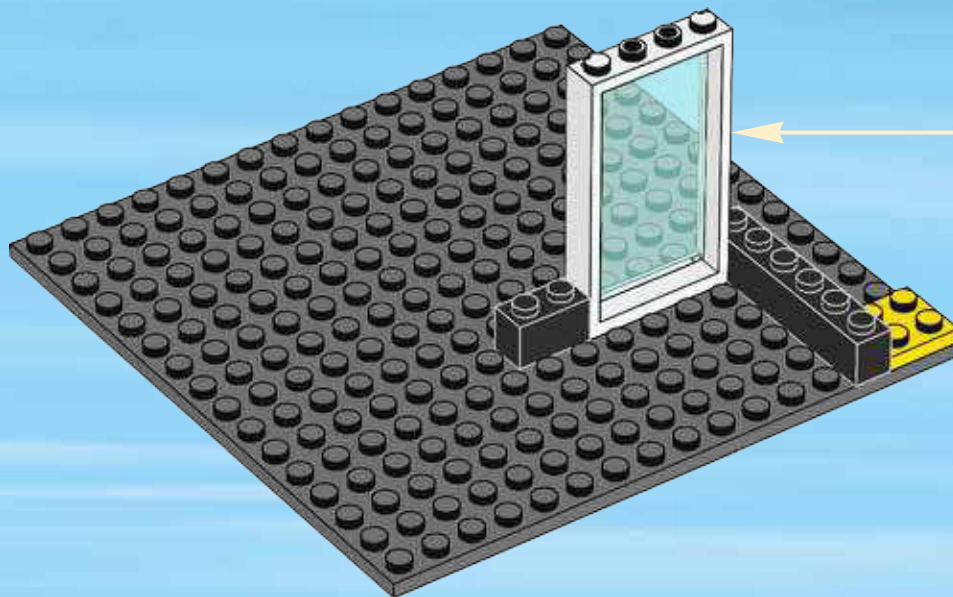
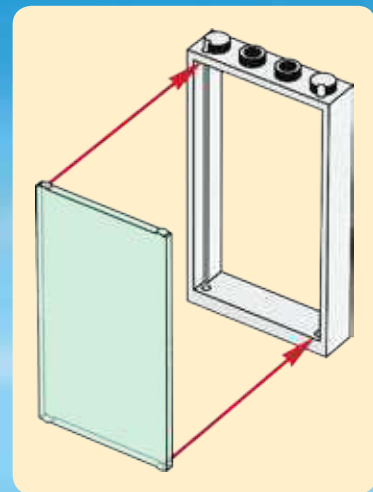

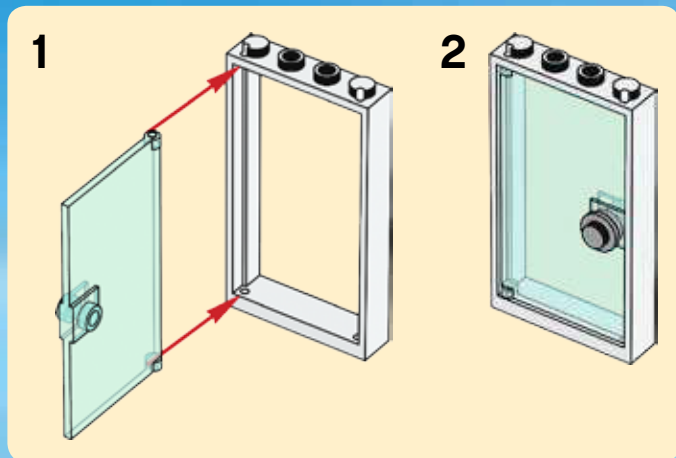
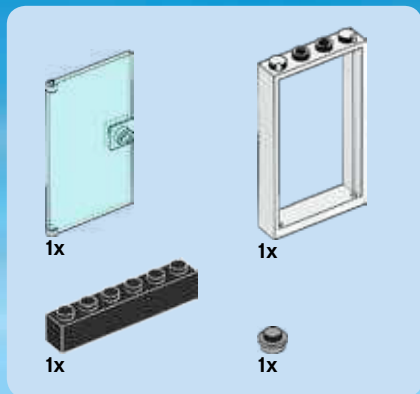

4

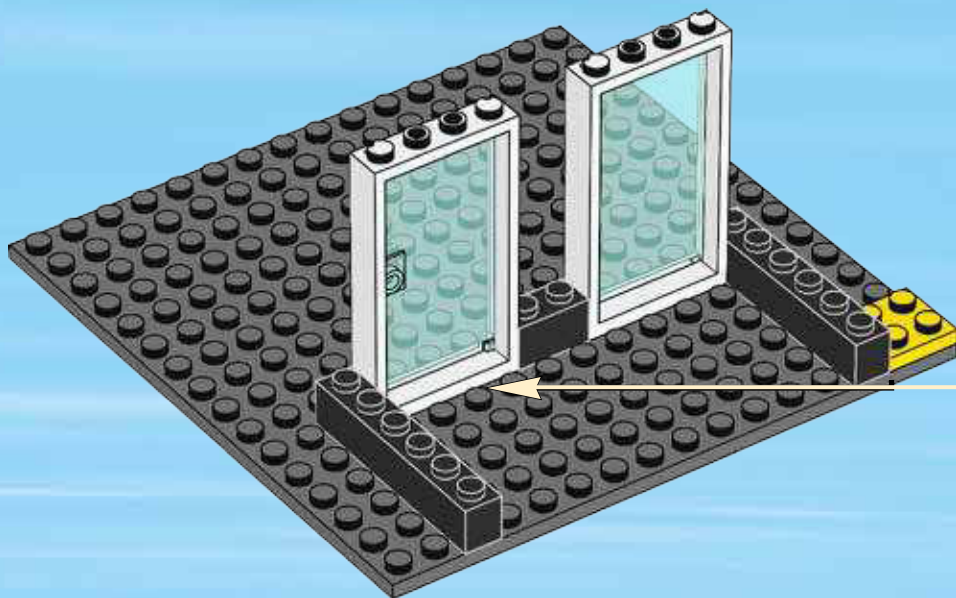

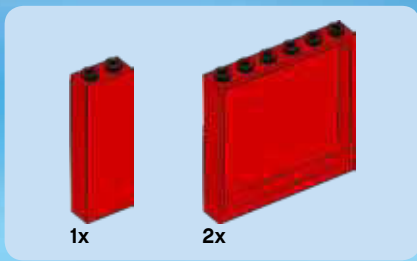

5

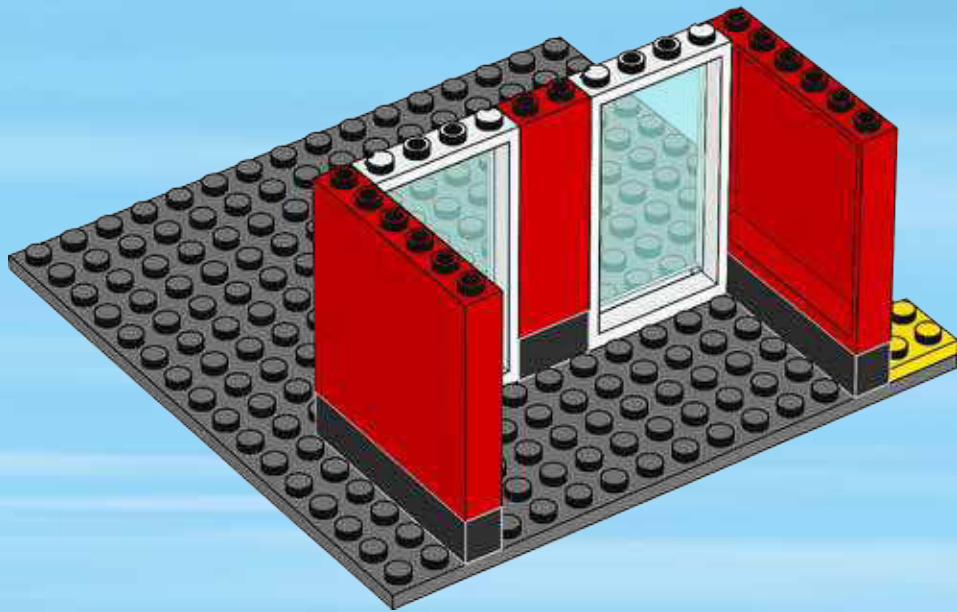

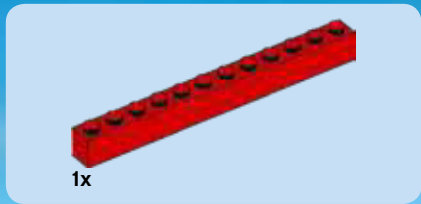

6

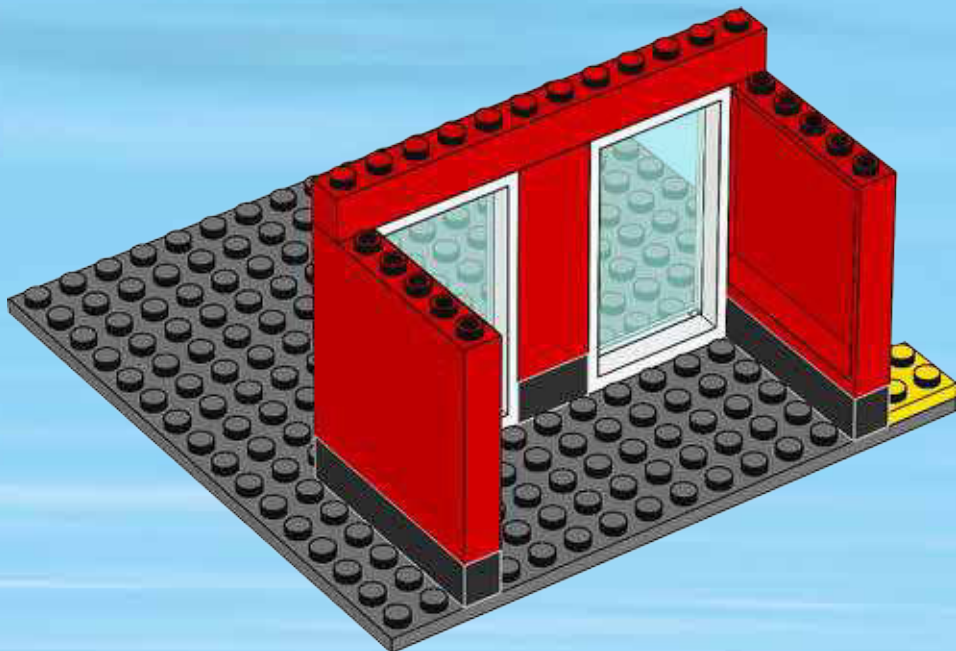

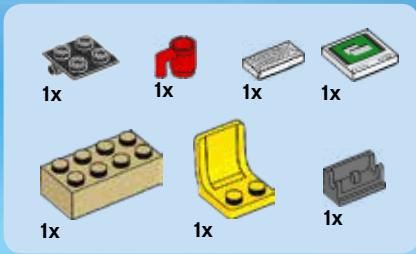

7

1



2



3

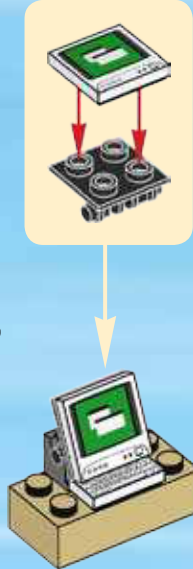

4



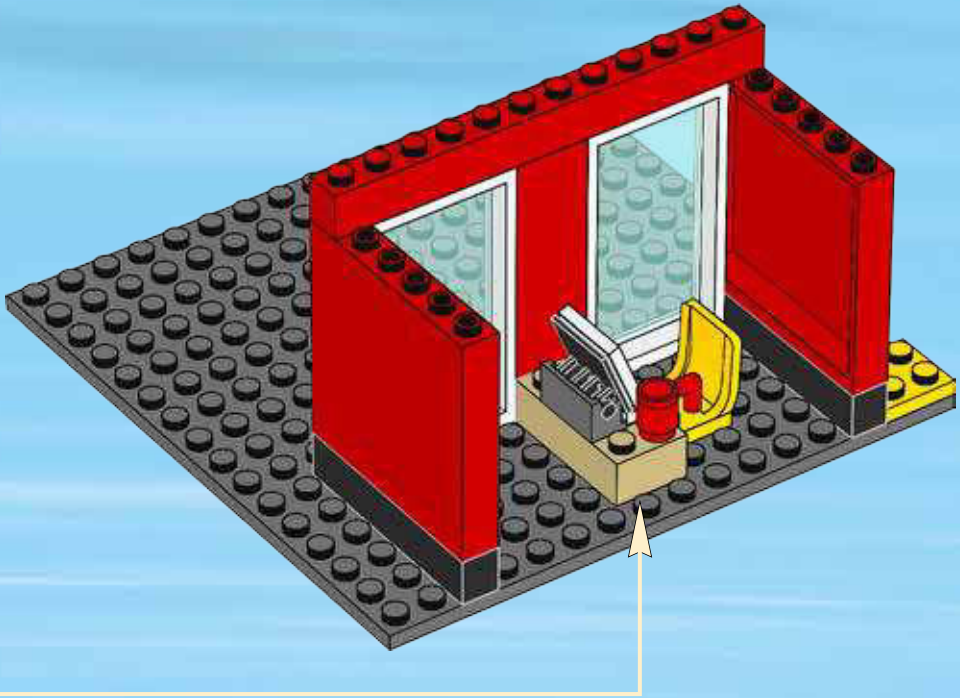

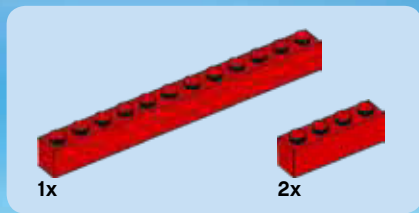

8

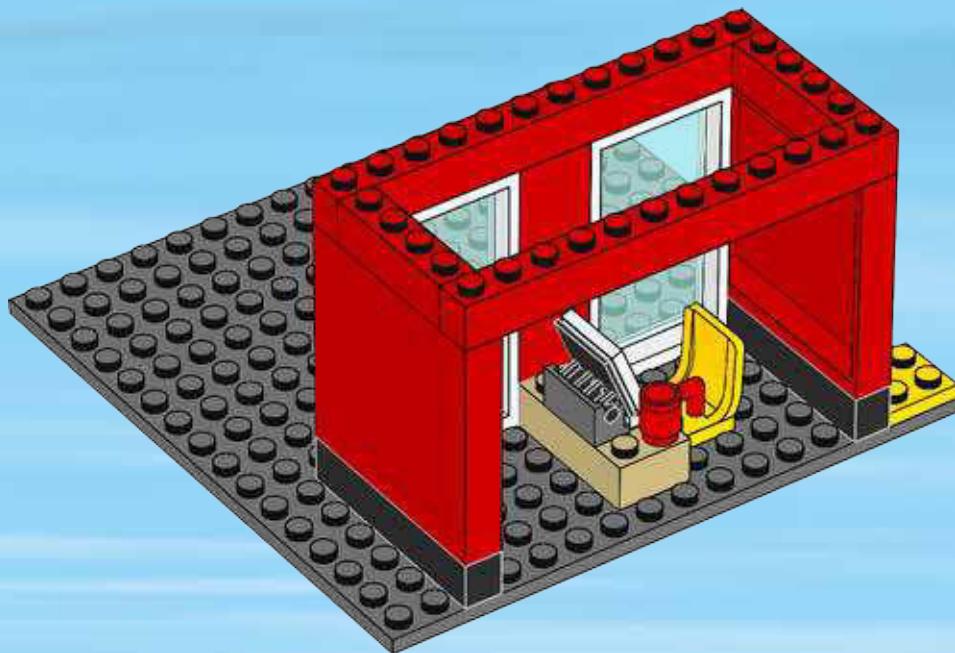



2x

9

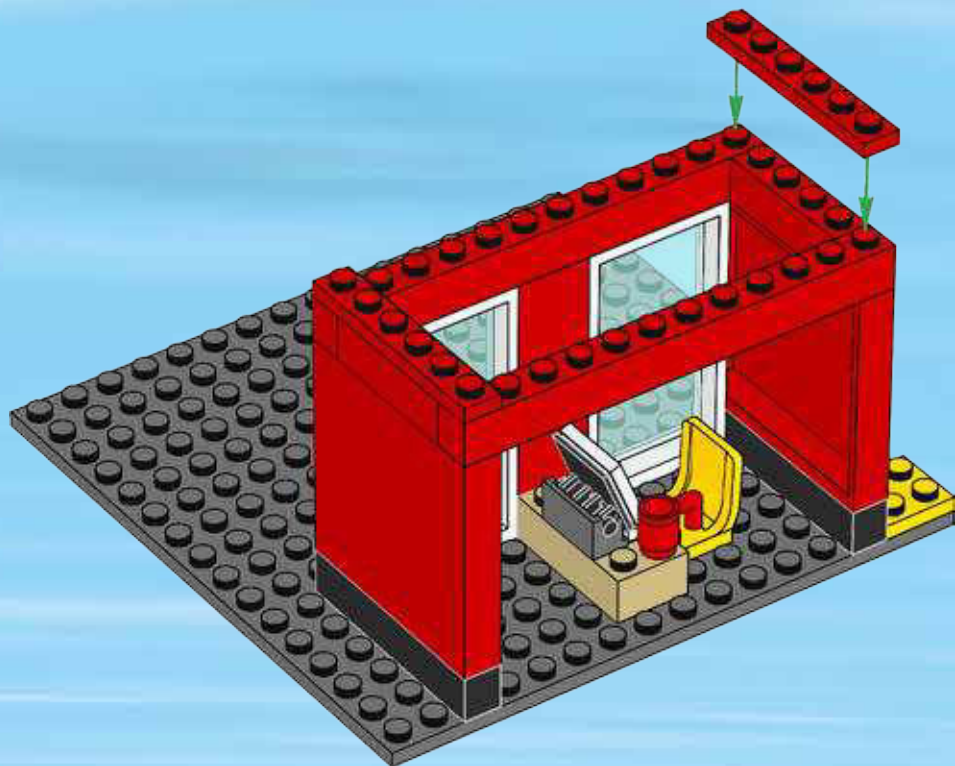

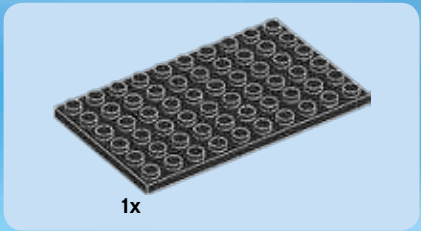

10

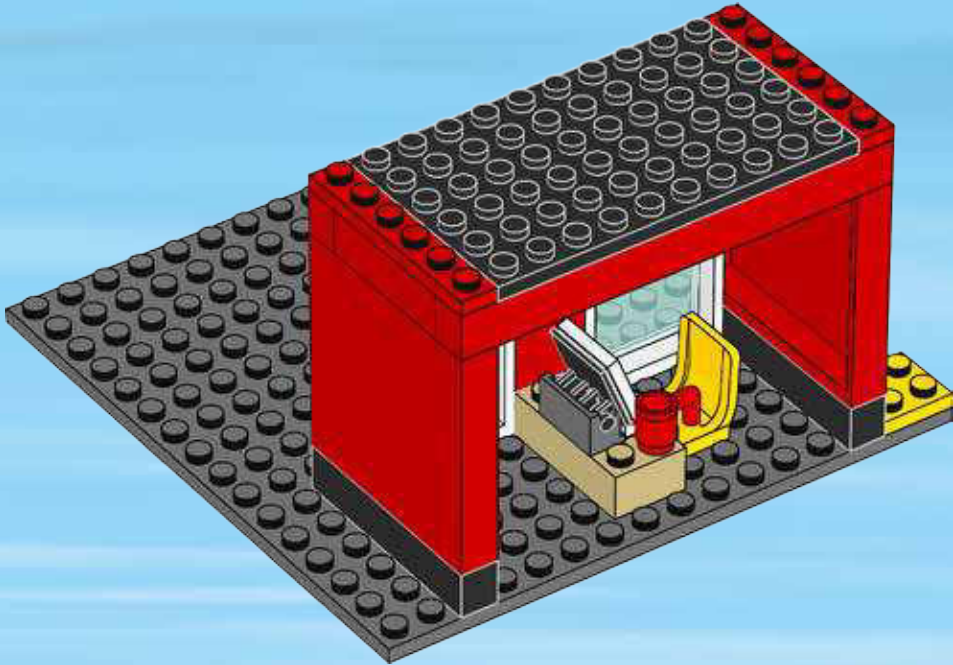

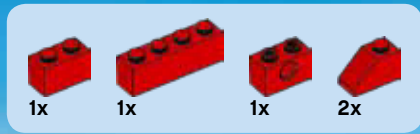

11

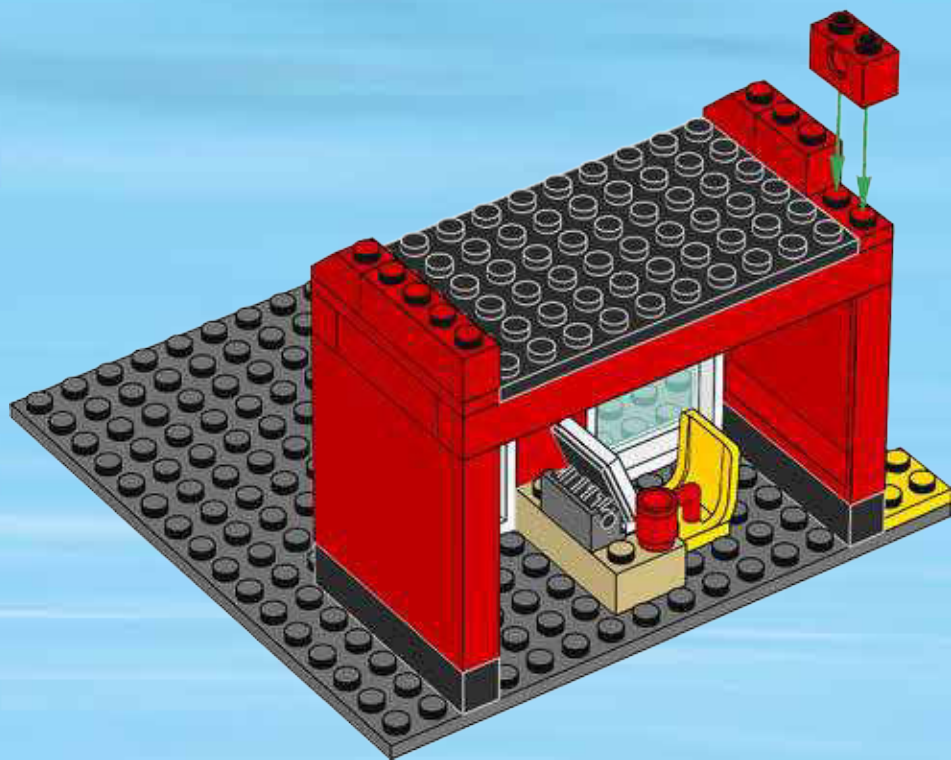

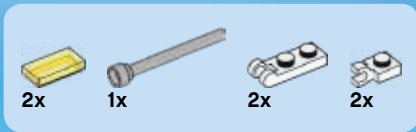

12

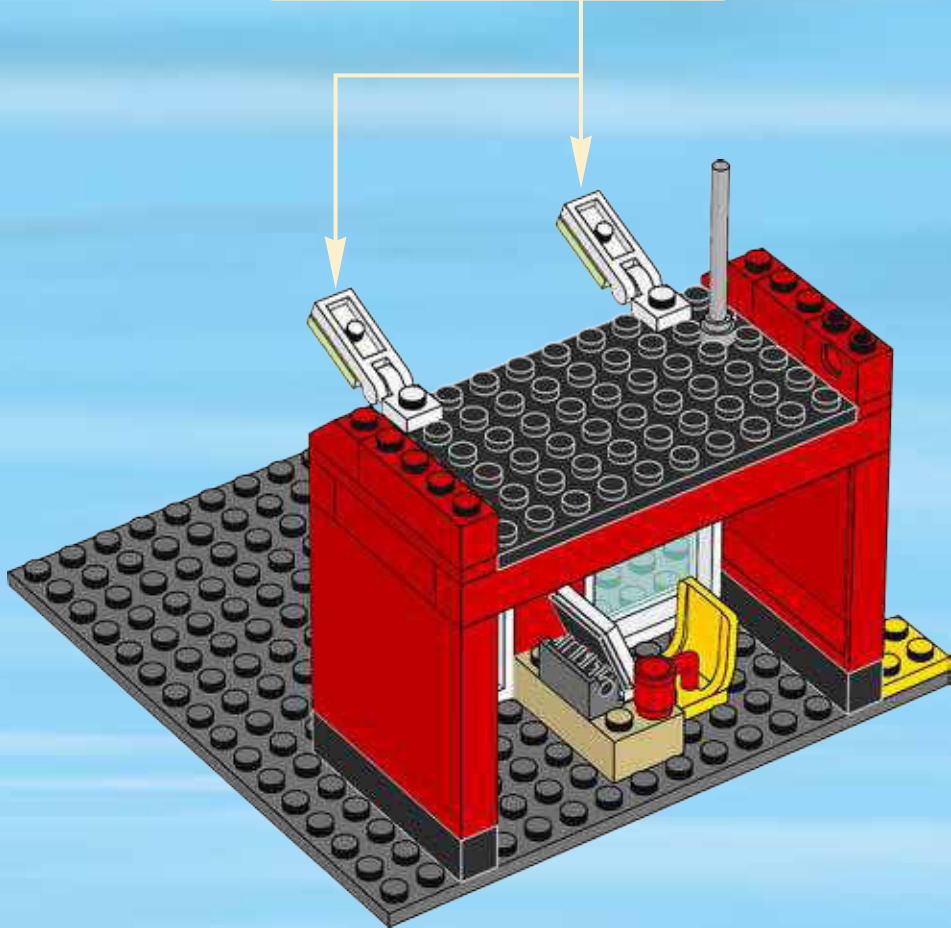
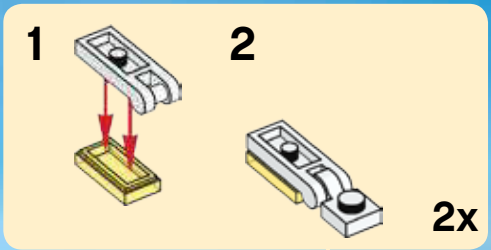

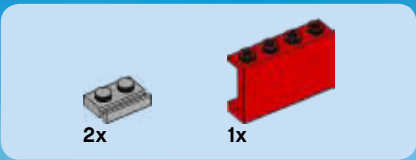

13

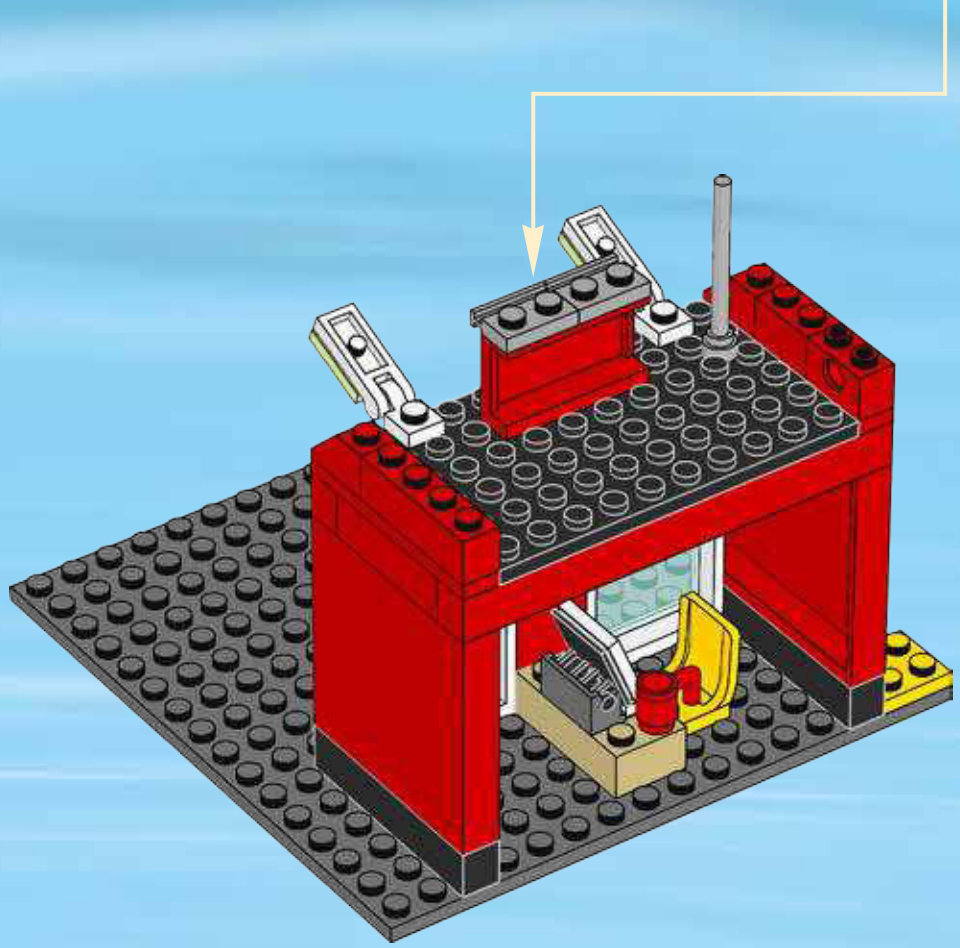
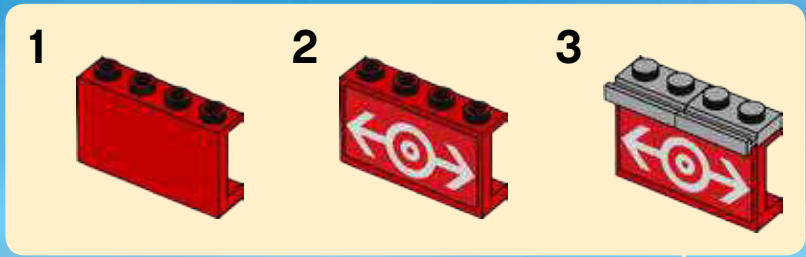



1x

14

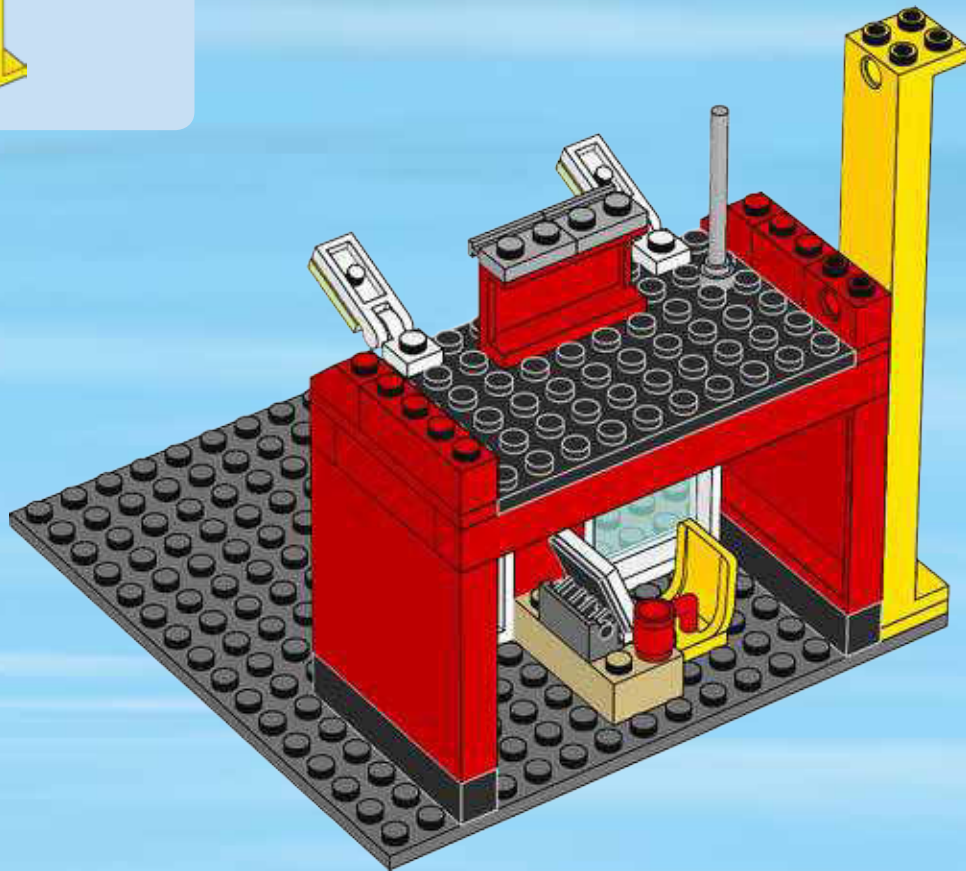



1x

15

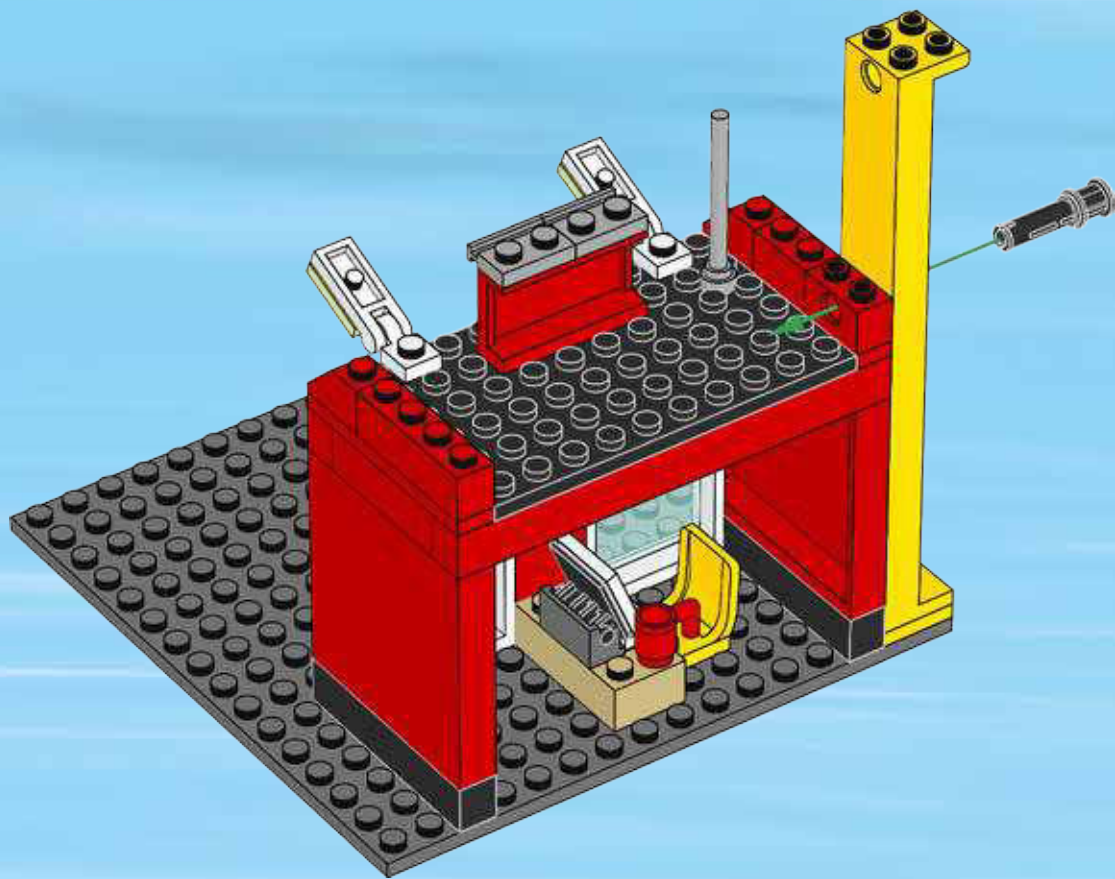

16

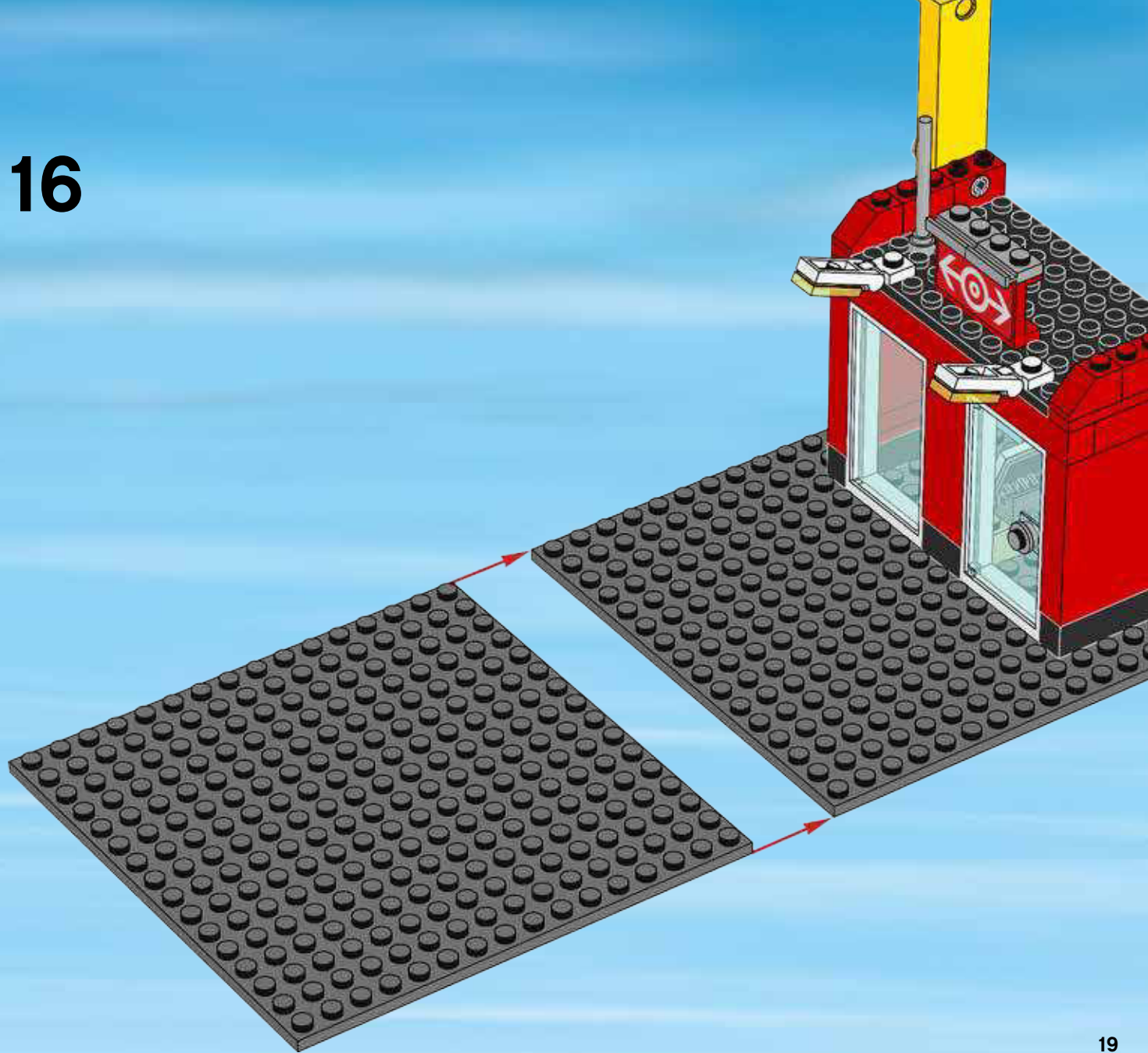



1x



1x



1x

17

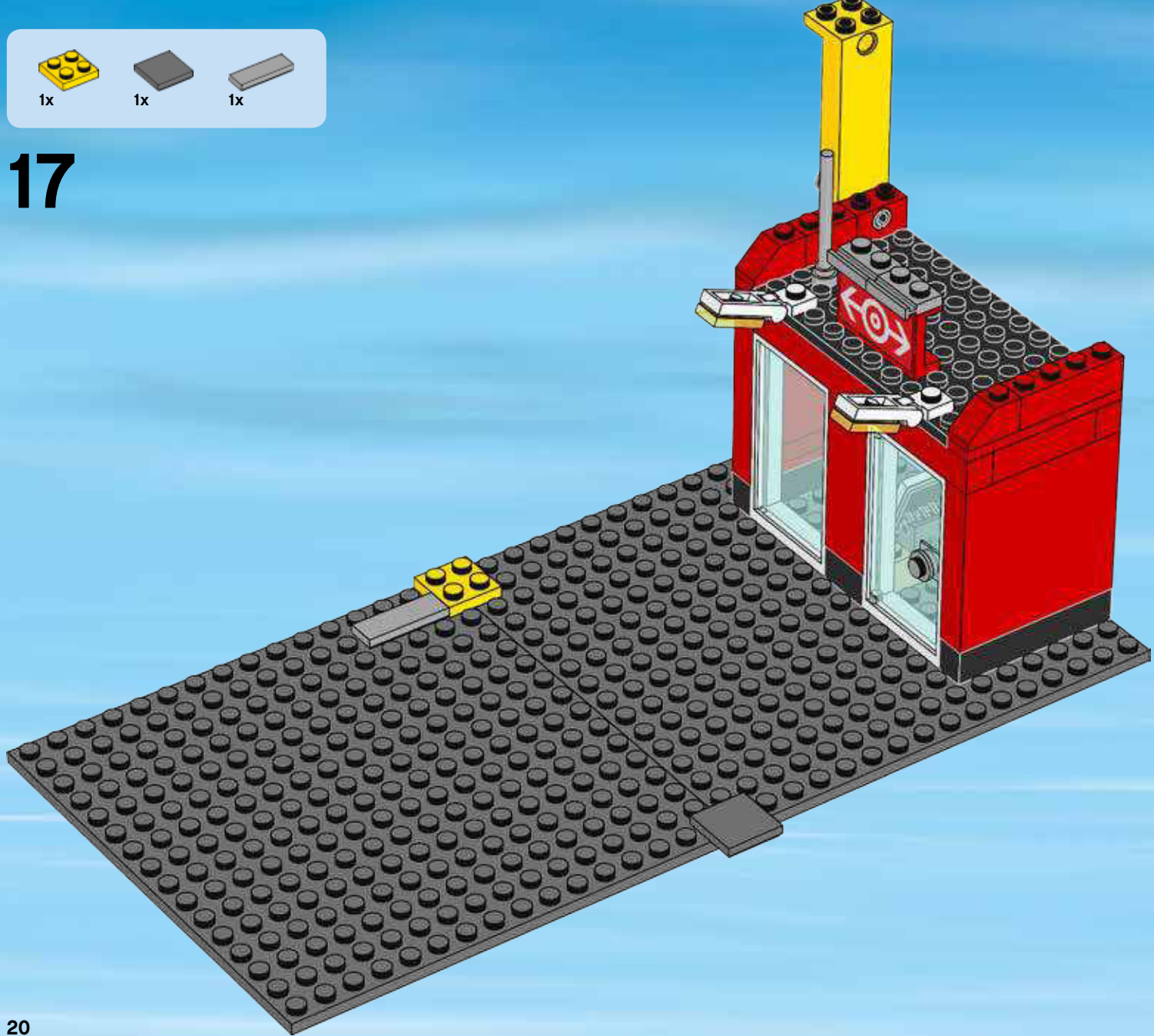



1x



1x



1x



1x



1x

18

1

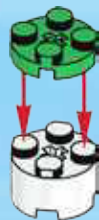

2



3



4



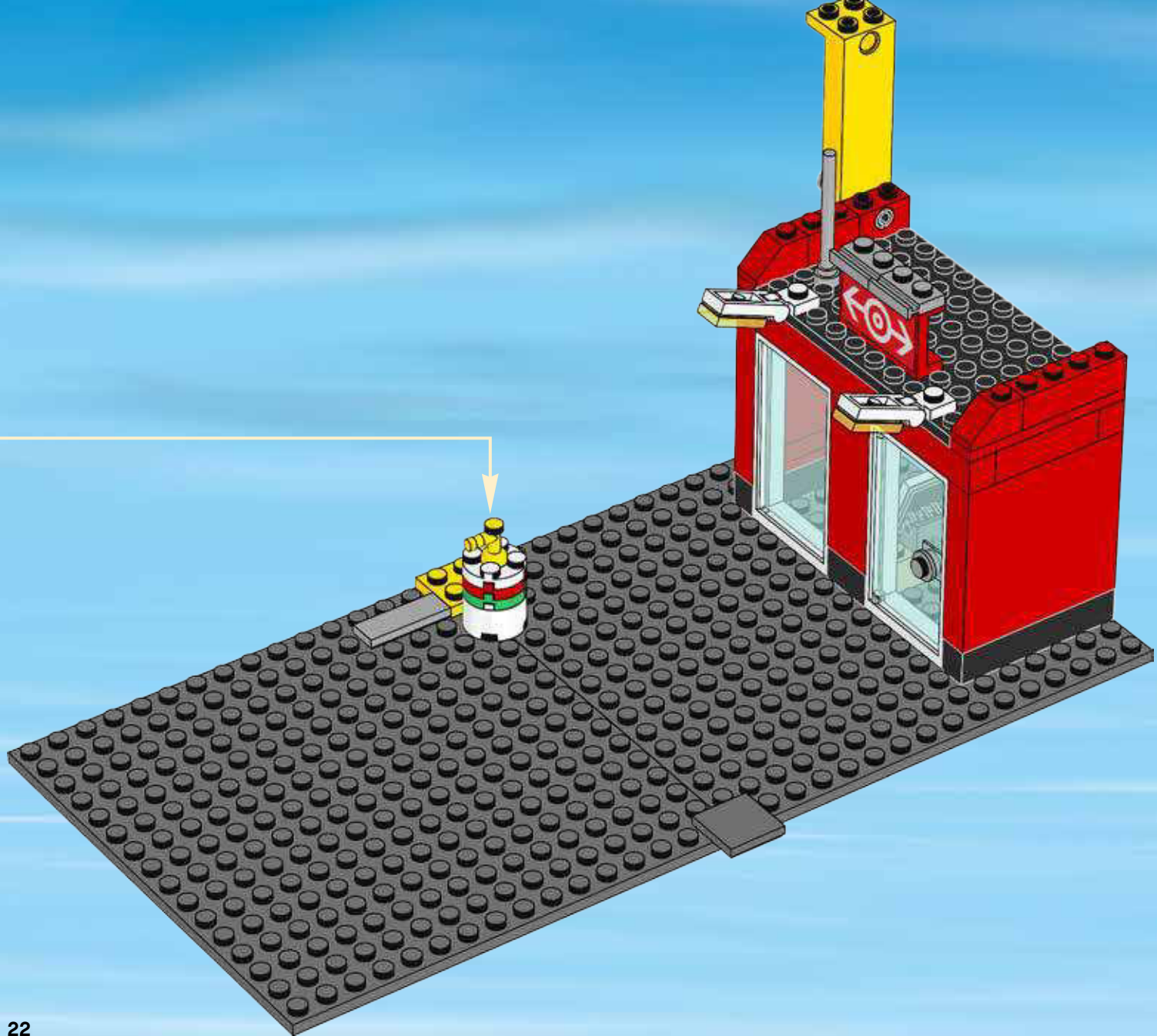



1x

19



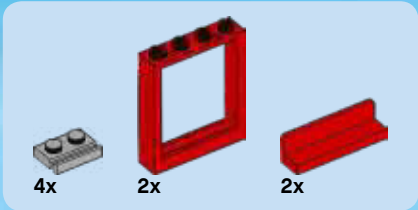
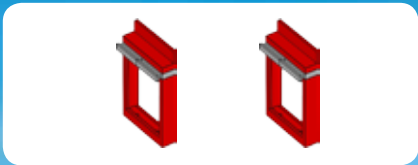

20

1

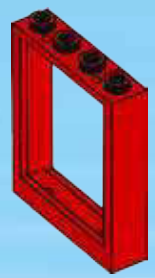

2

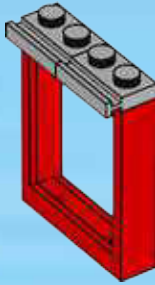

3

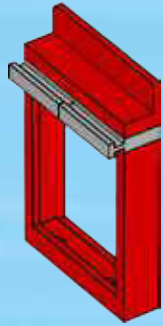

2x

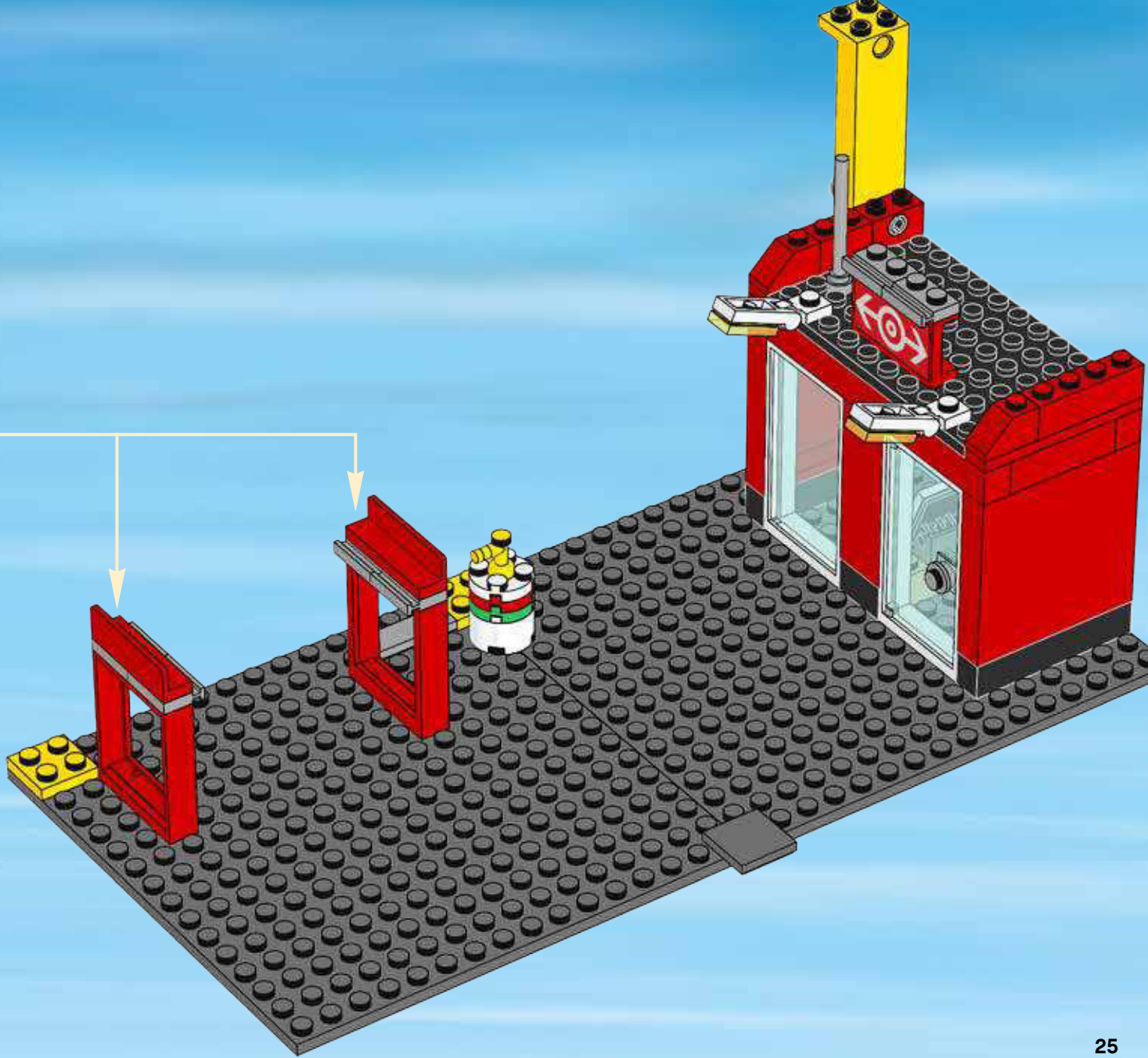



2x

21

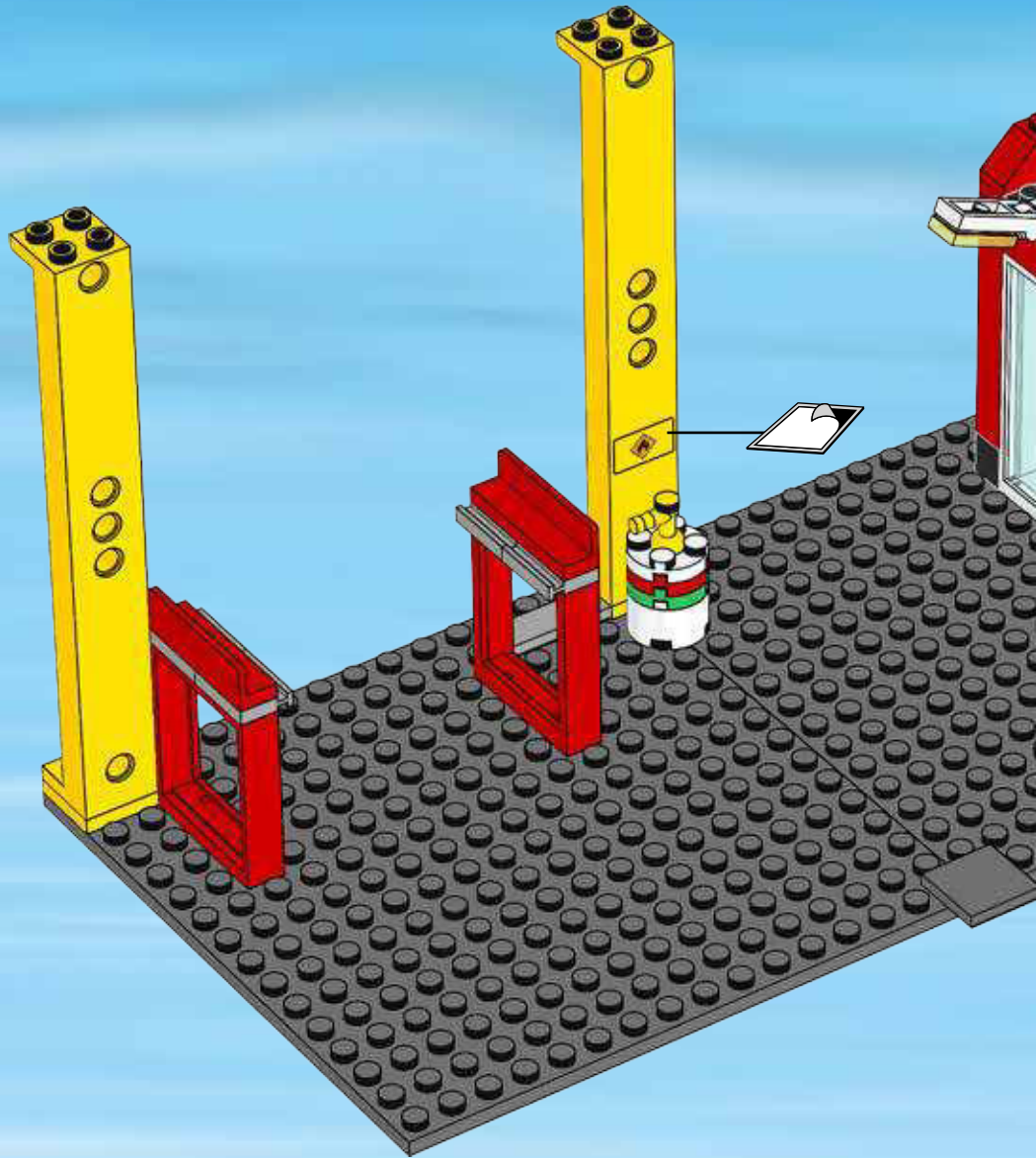

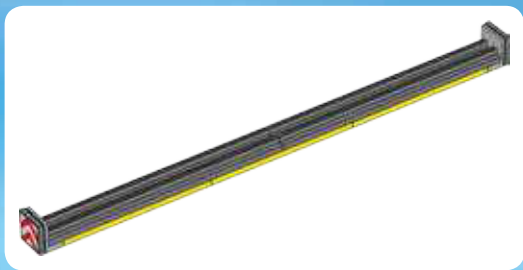

1

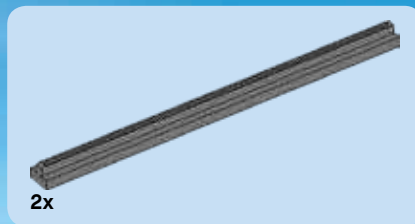
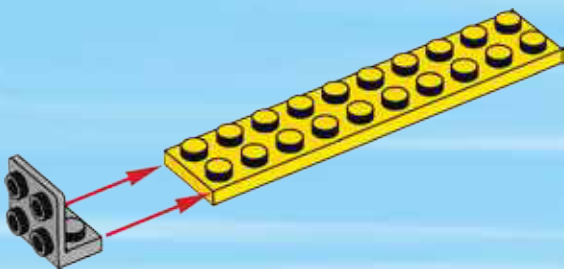

2

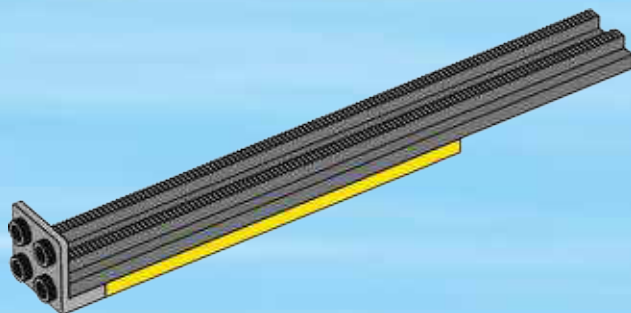

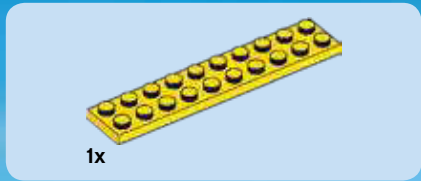

3

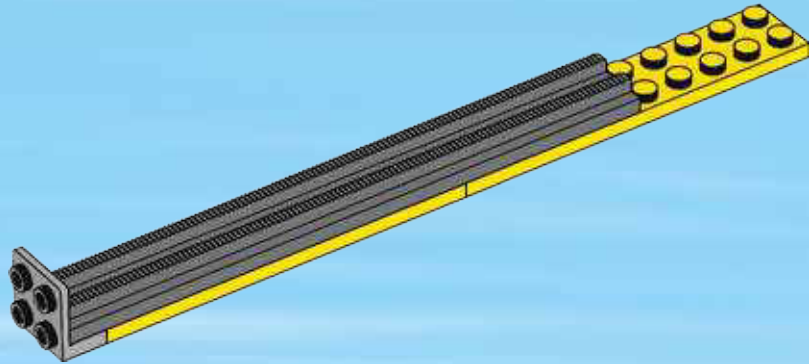

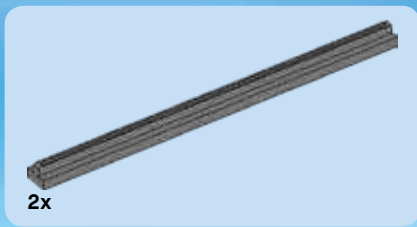

4

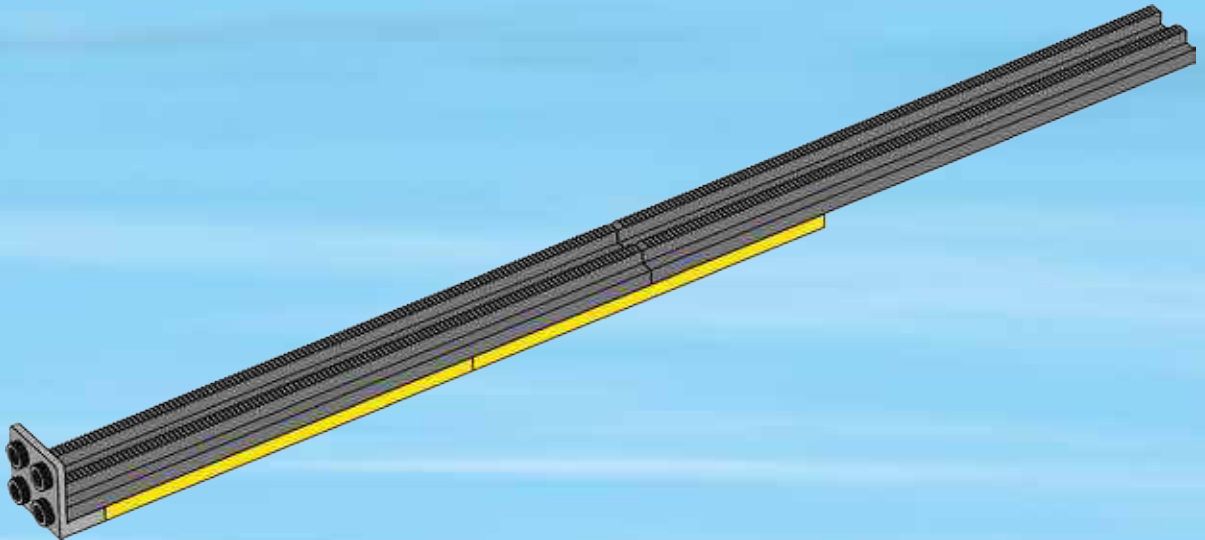

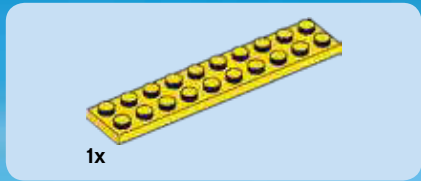

5

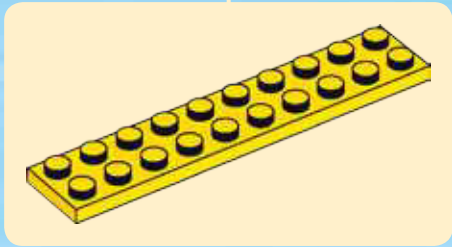
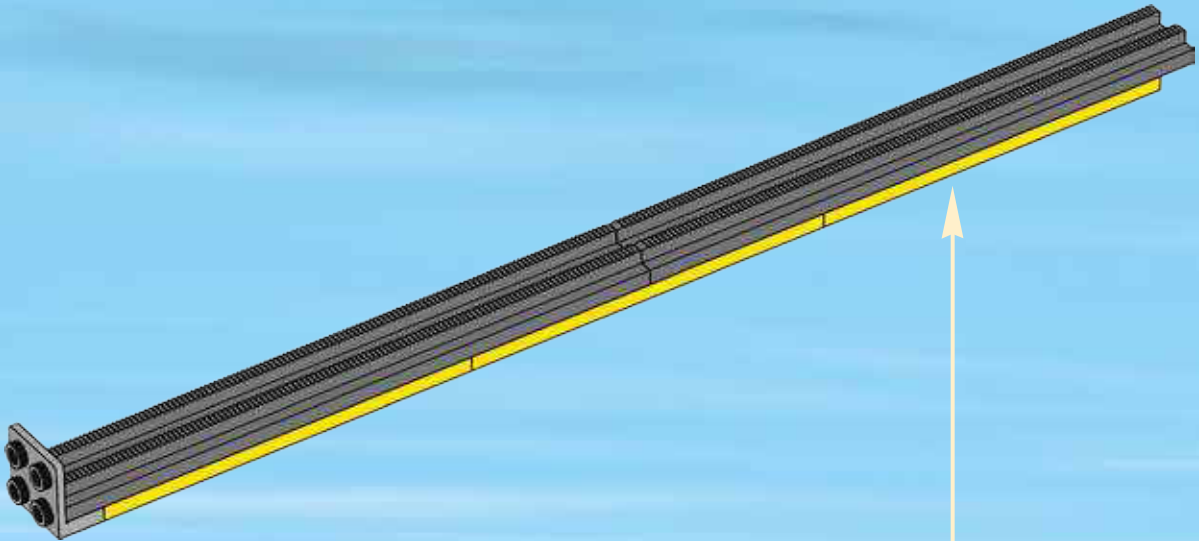



1x

6

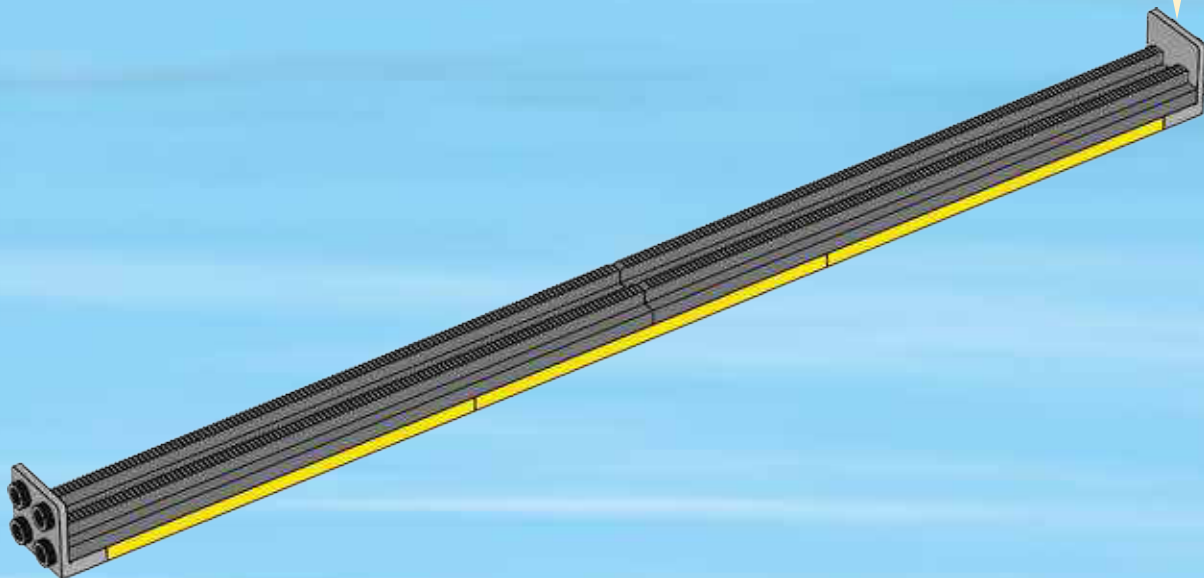
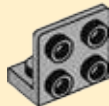



2x

7

1

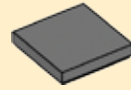

2



2x

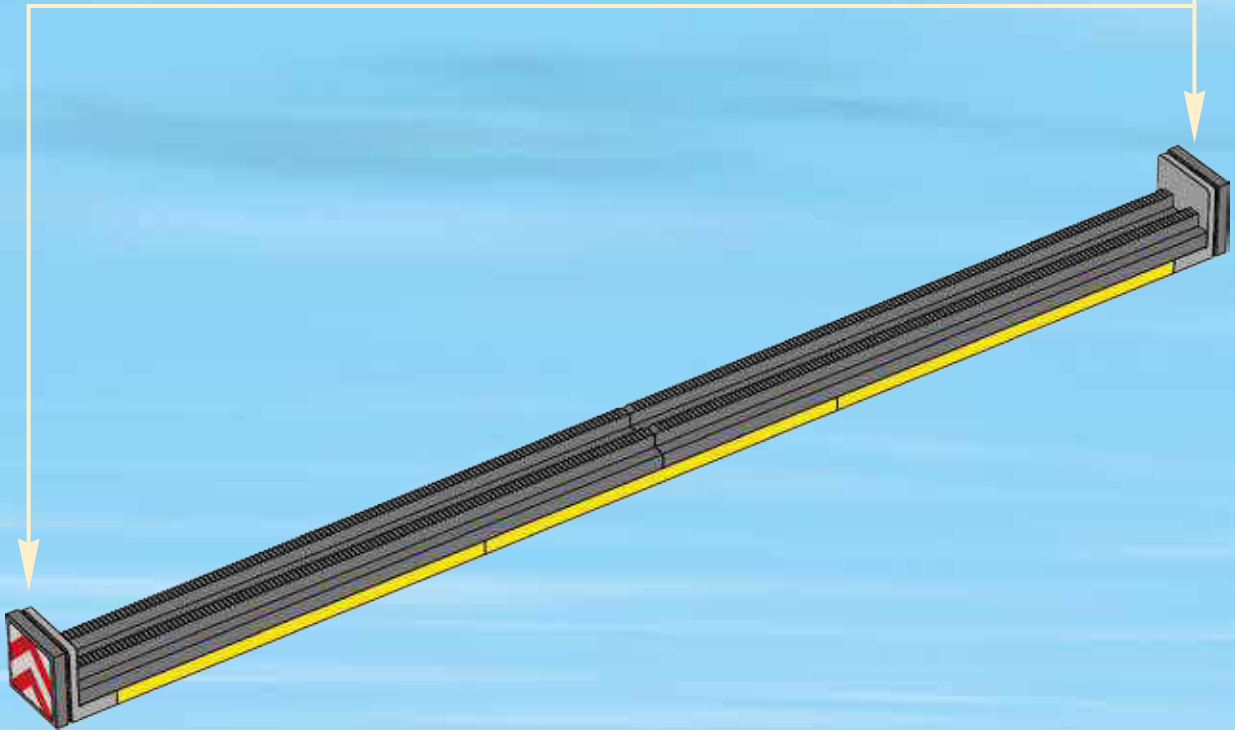

22

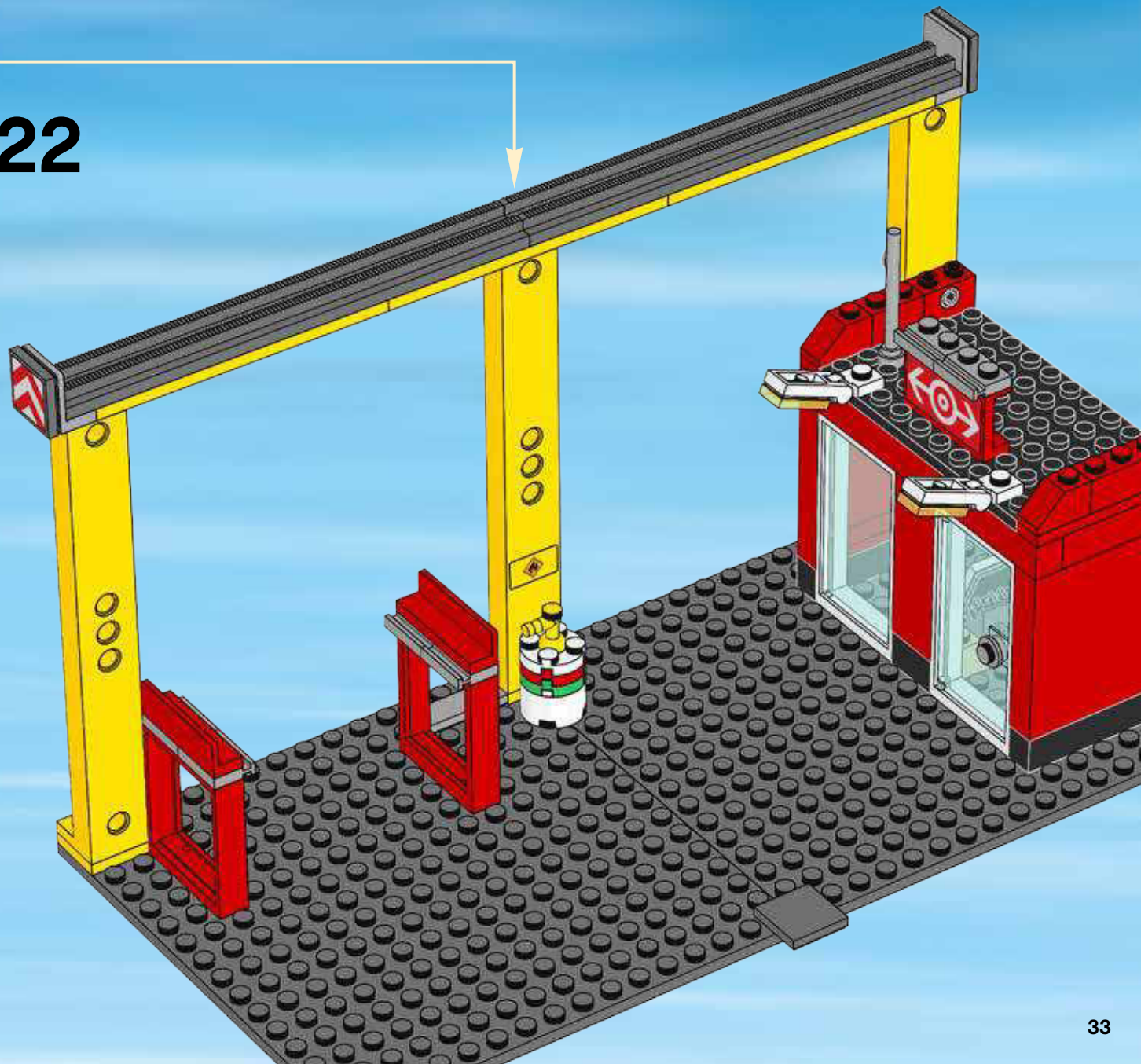

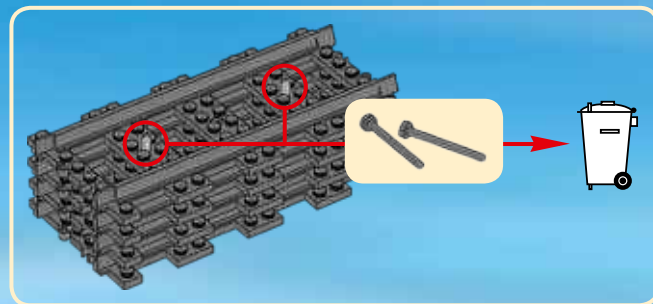
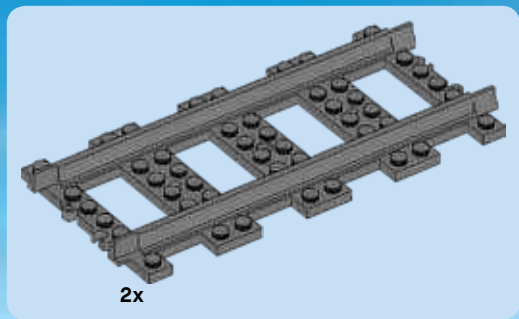

23

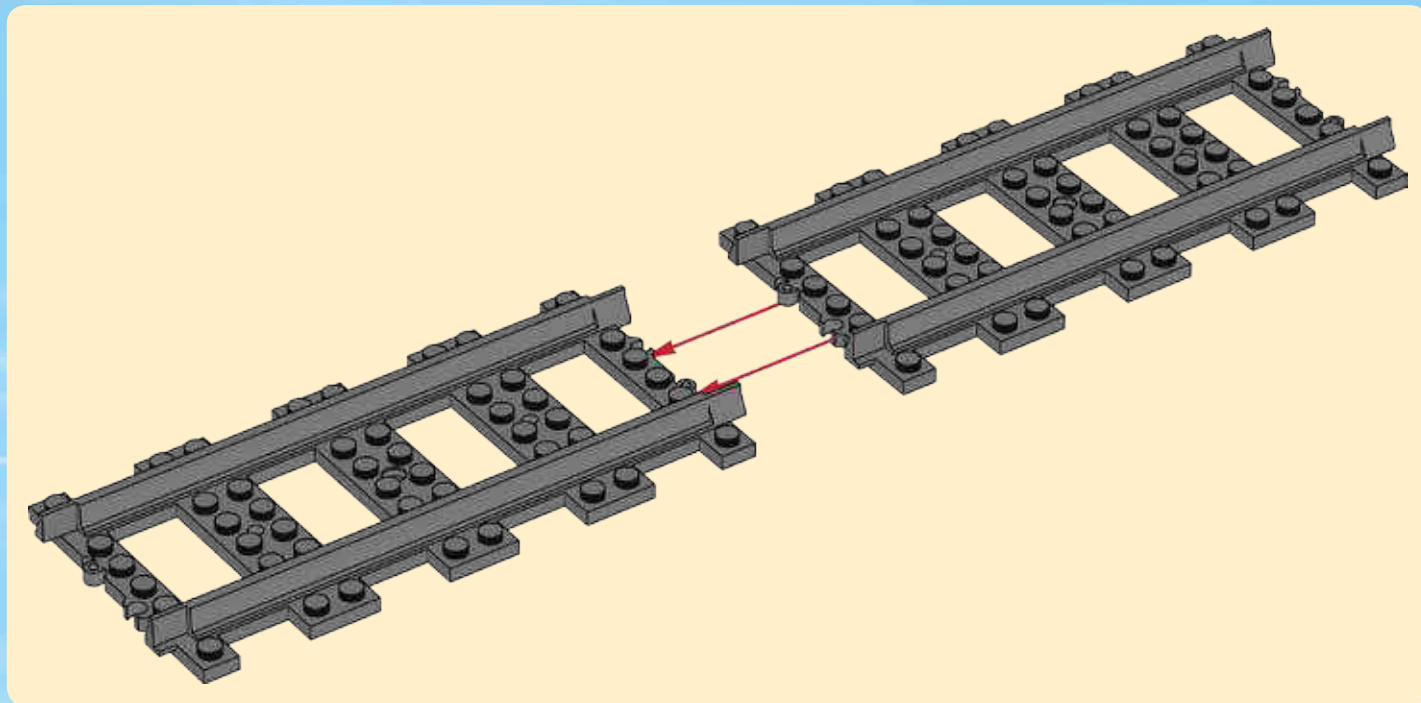

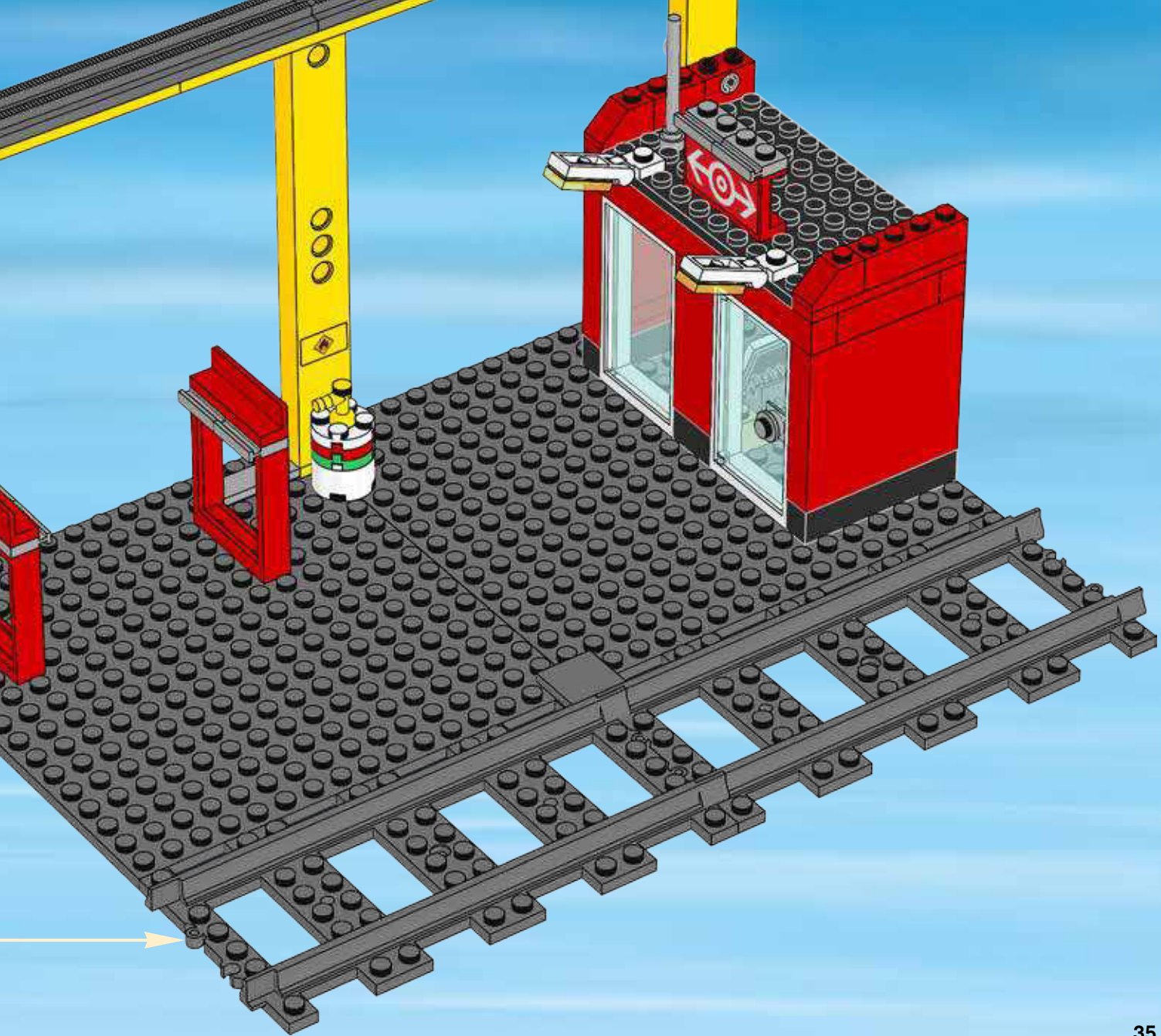



6x

24

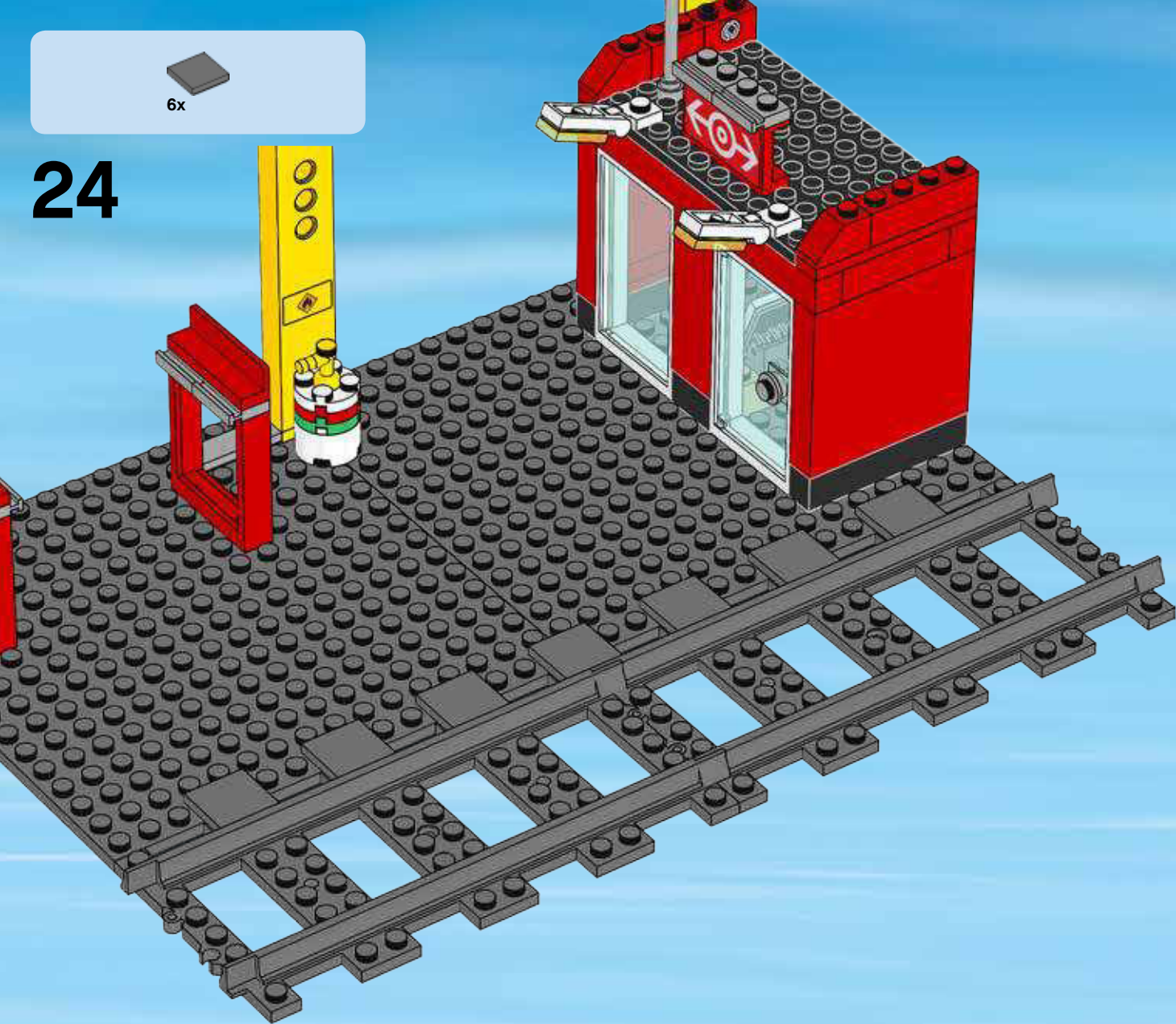

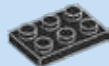

3x



3x

25

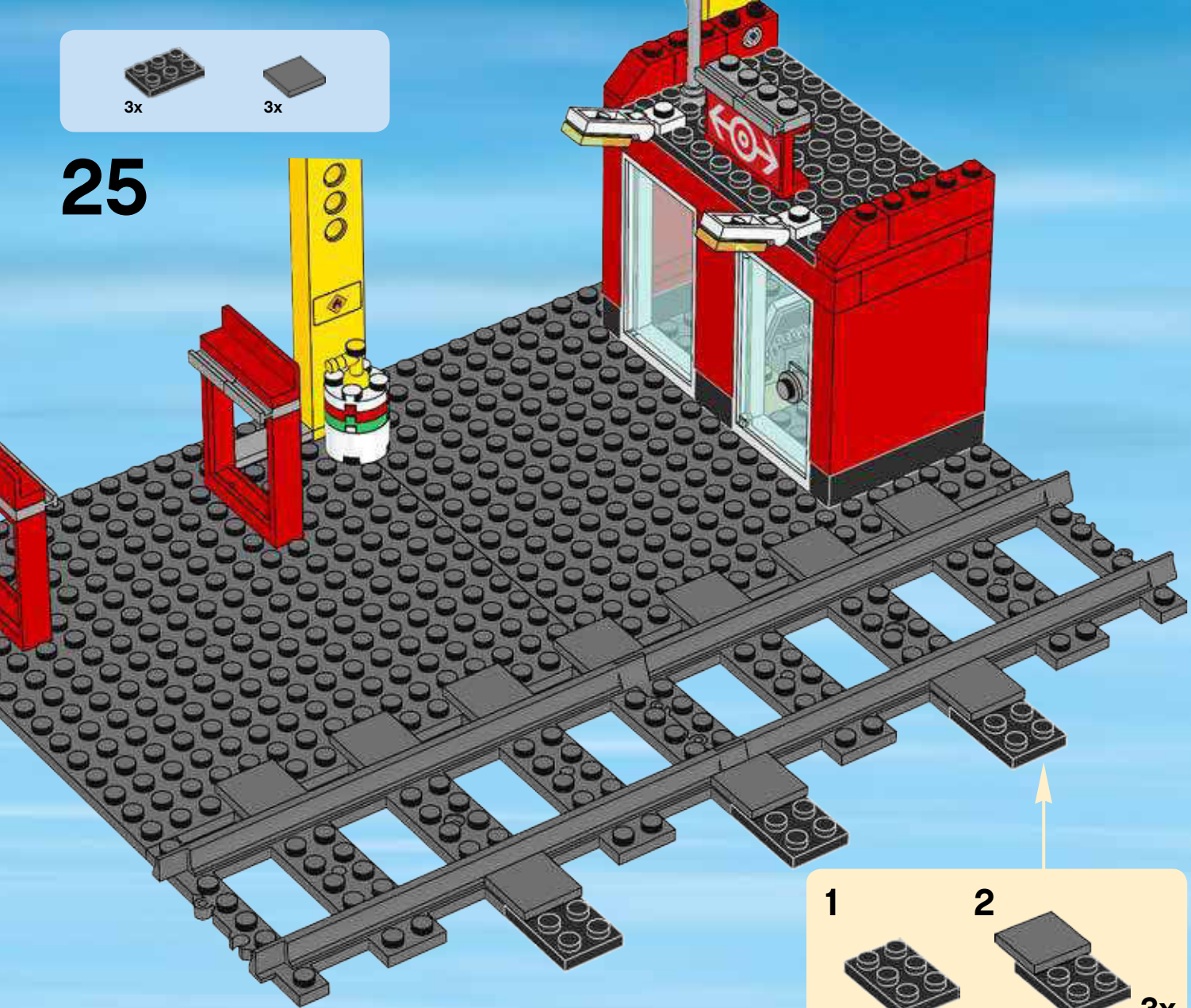

1



2



3x

1x  1x  1x 

26

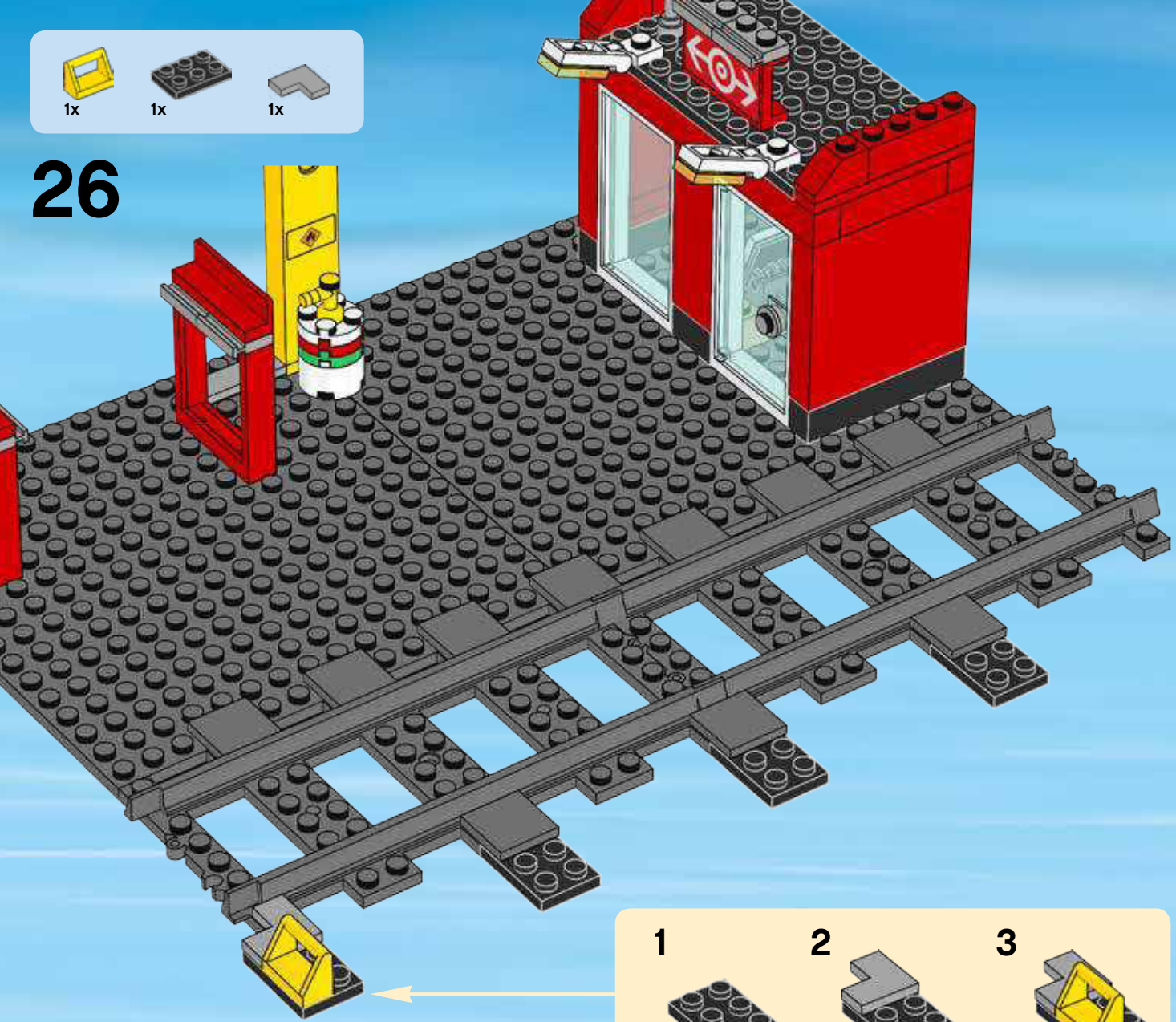

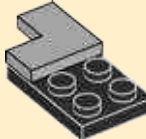
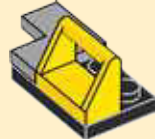
1  2  3 



1x

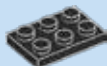

1x



1x

27

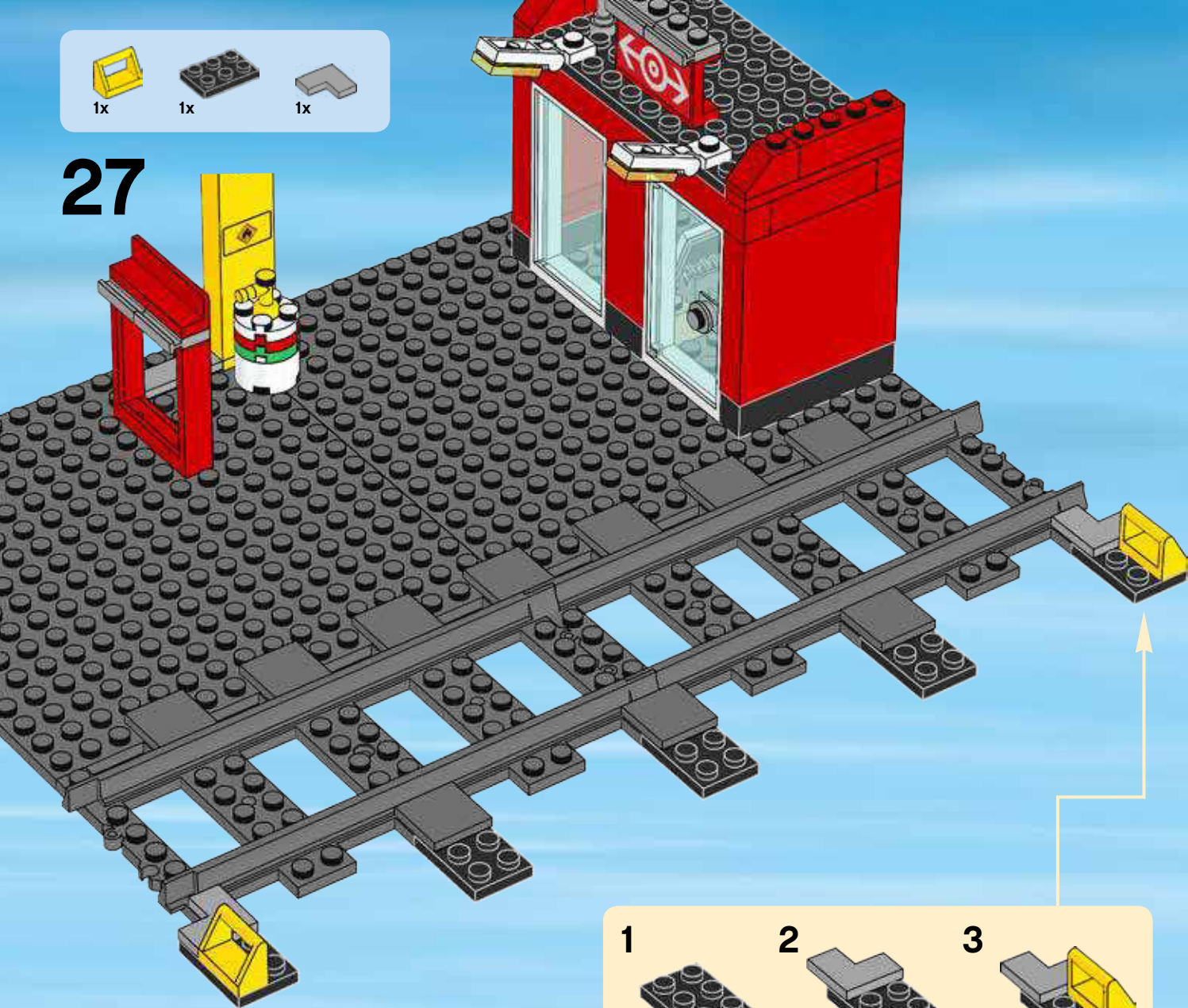

1



2



3

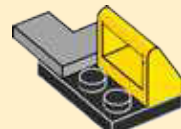

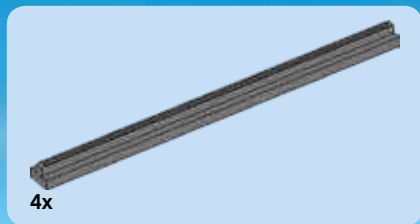

28

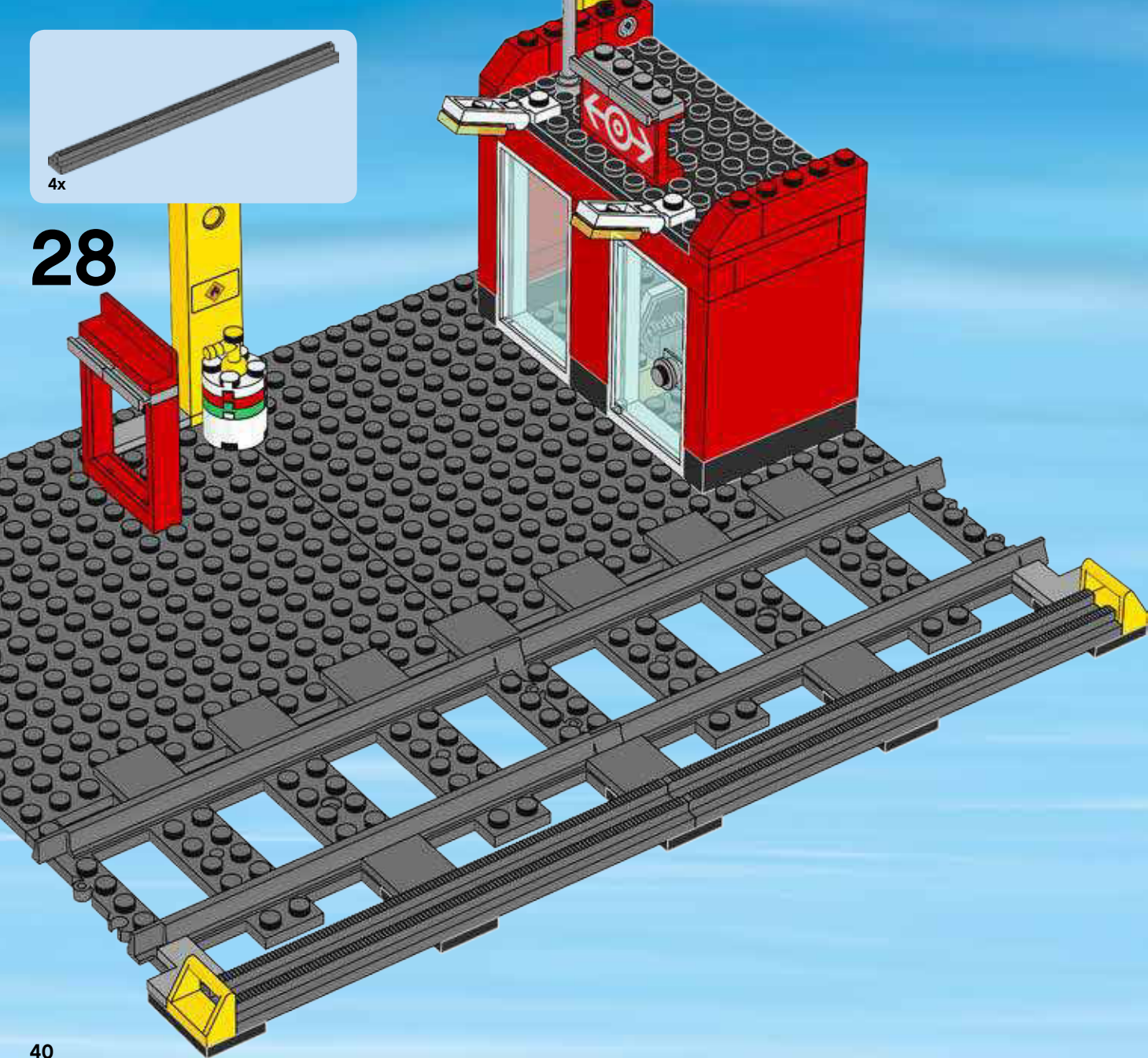

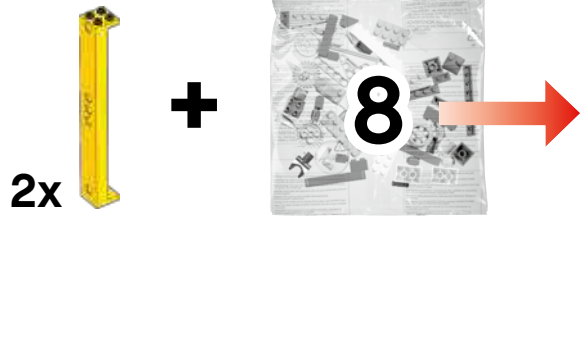

1

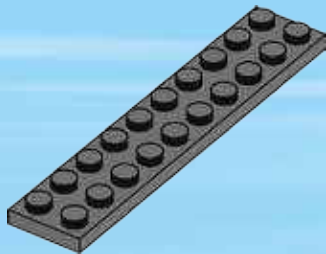

2

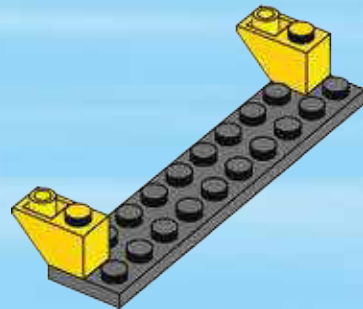



2x

3

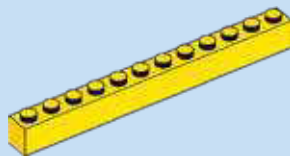
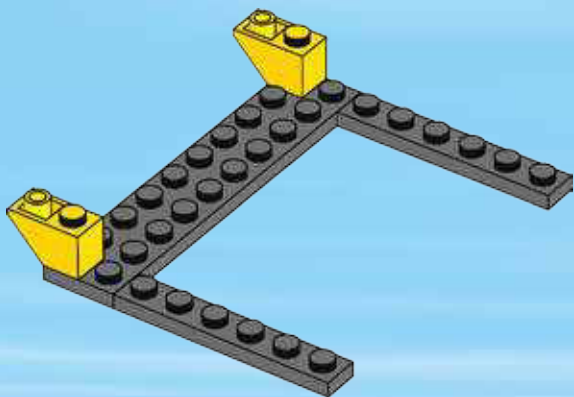

2x

4

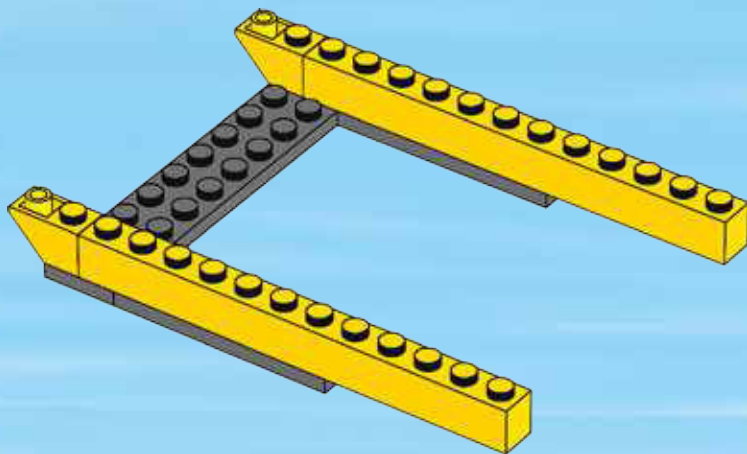

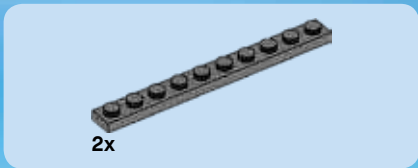

5

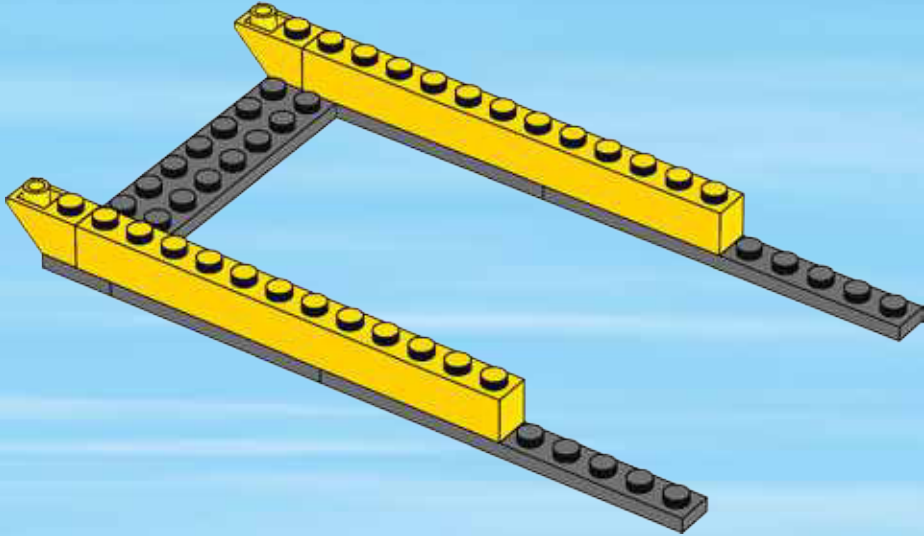

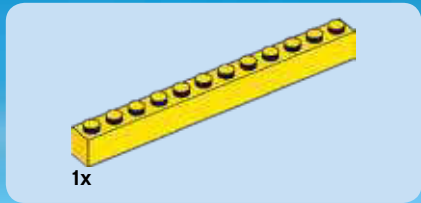

6

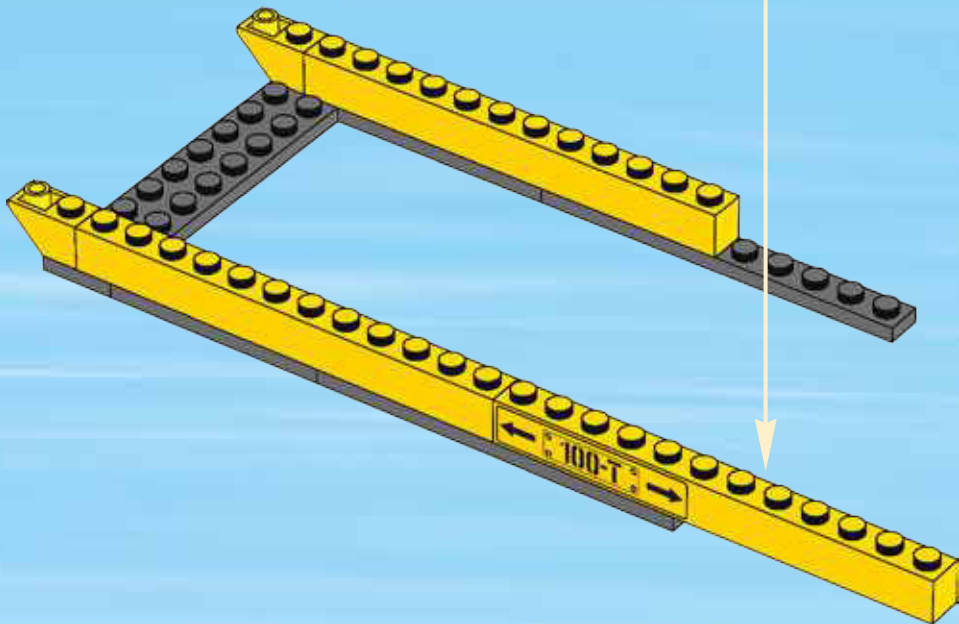
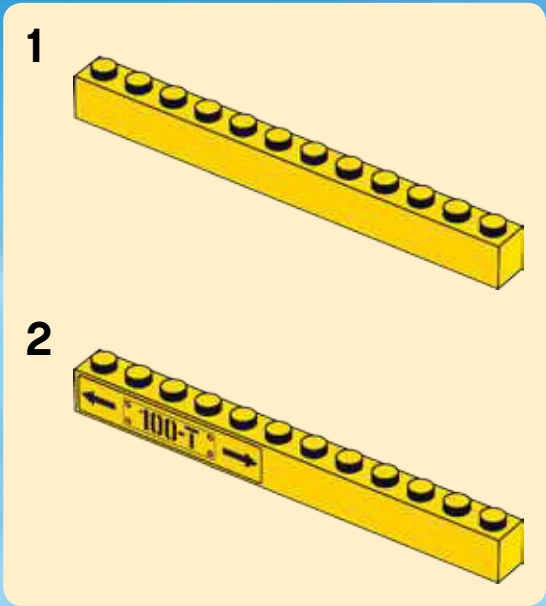

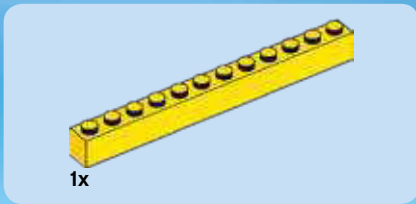

7

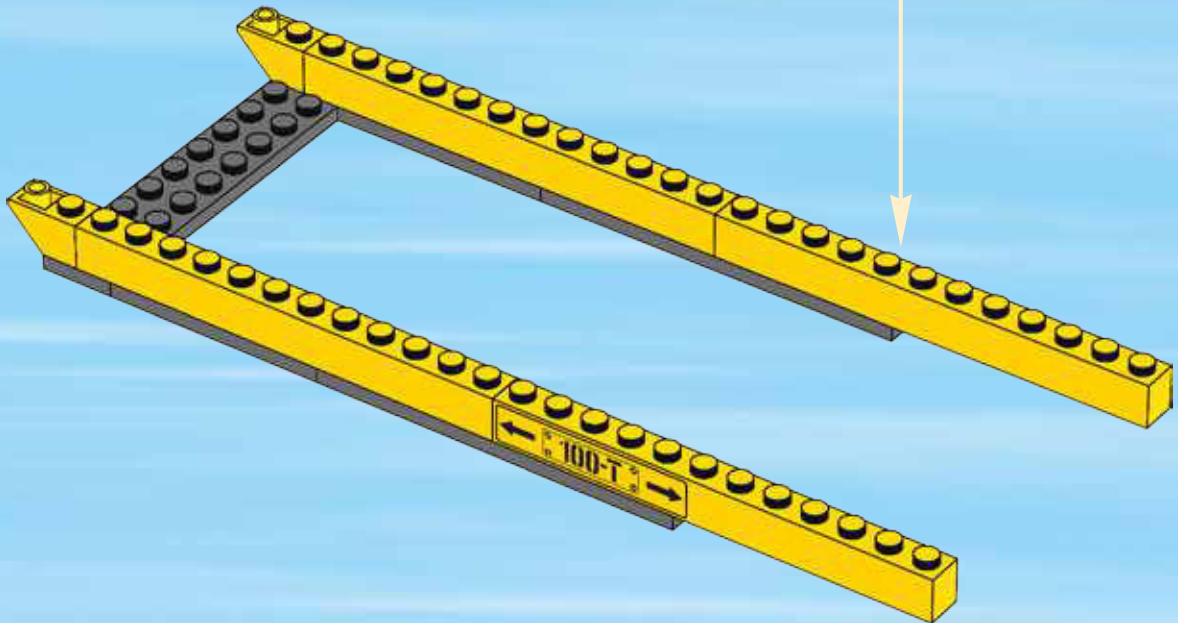
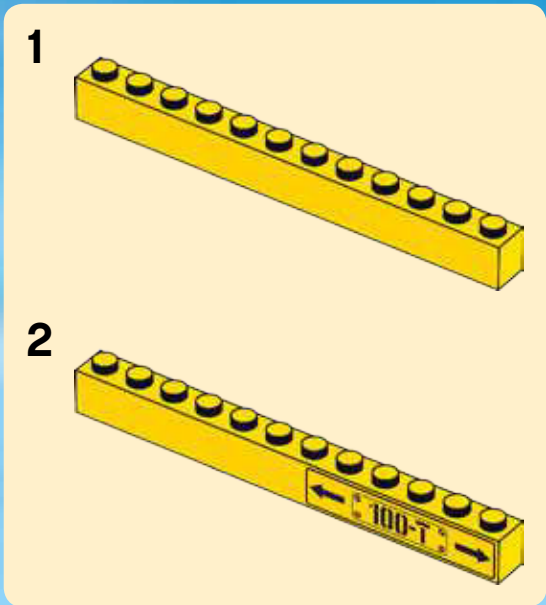

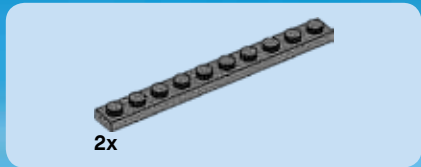

8

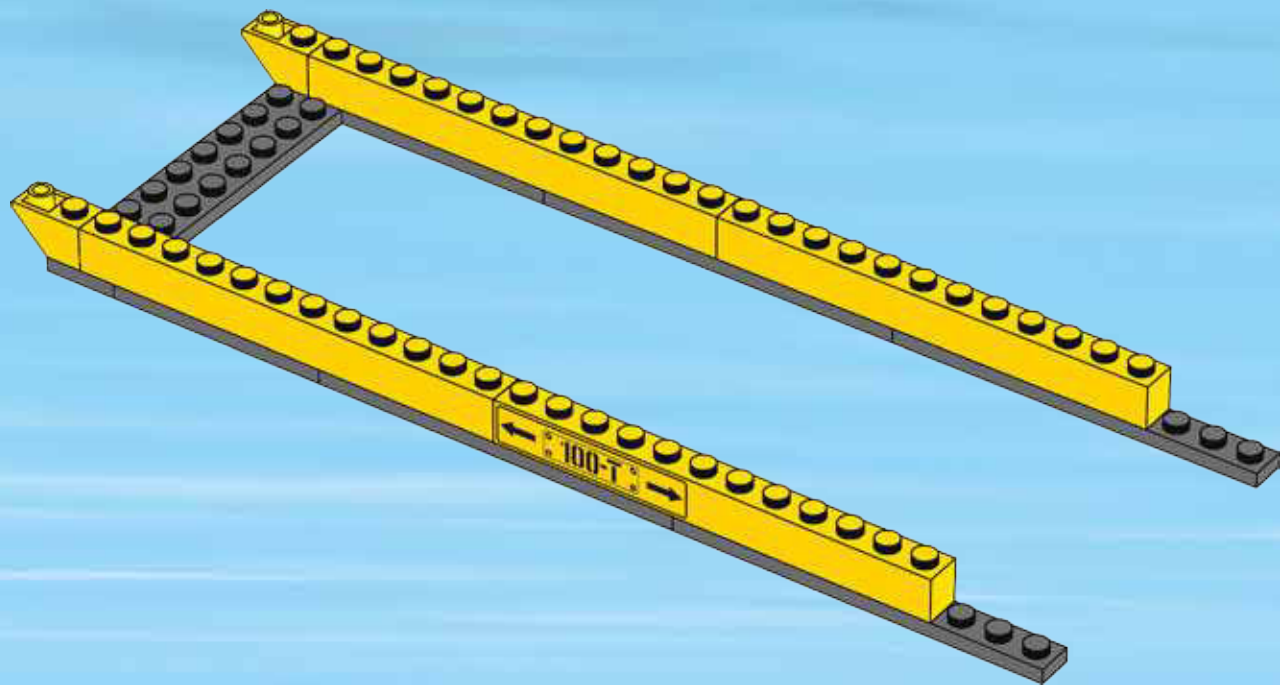



2x



2x

9

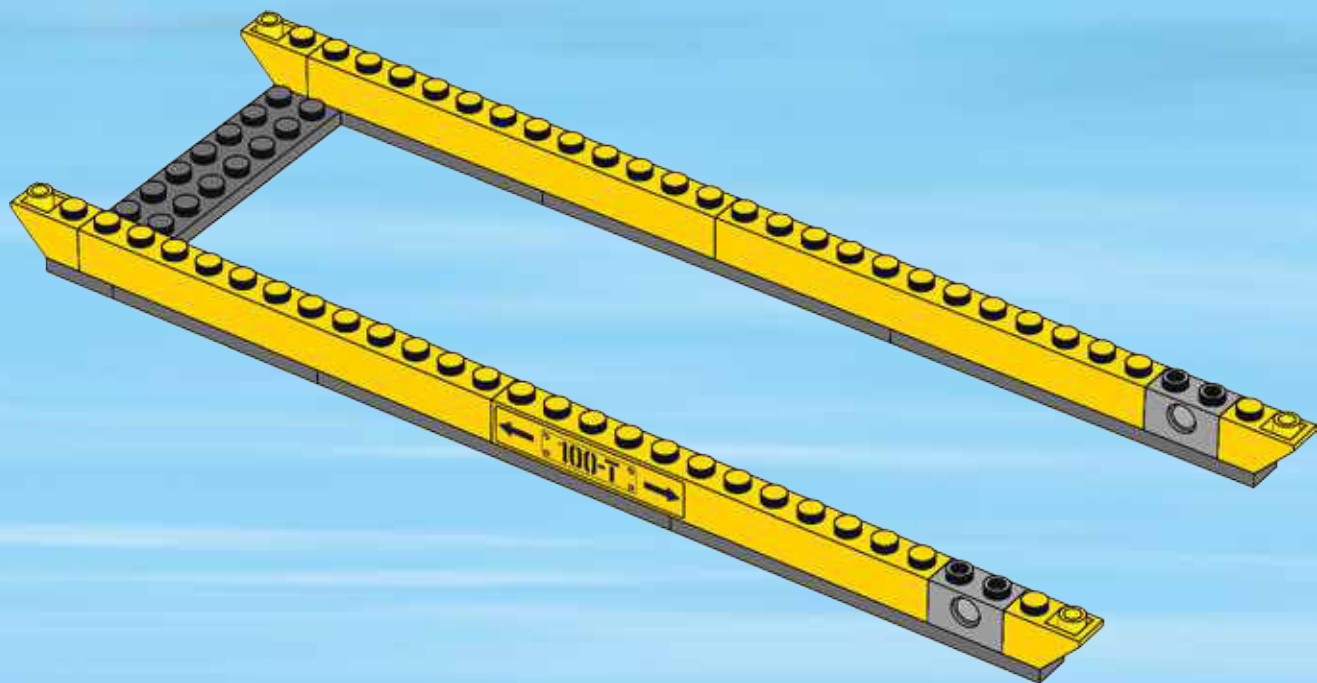

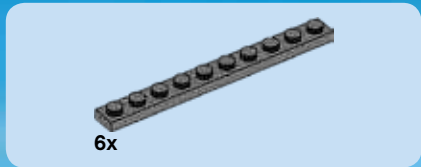

10

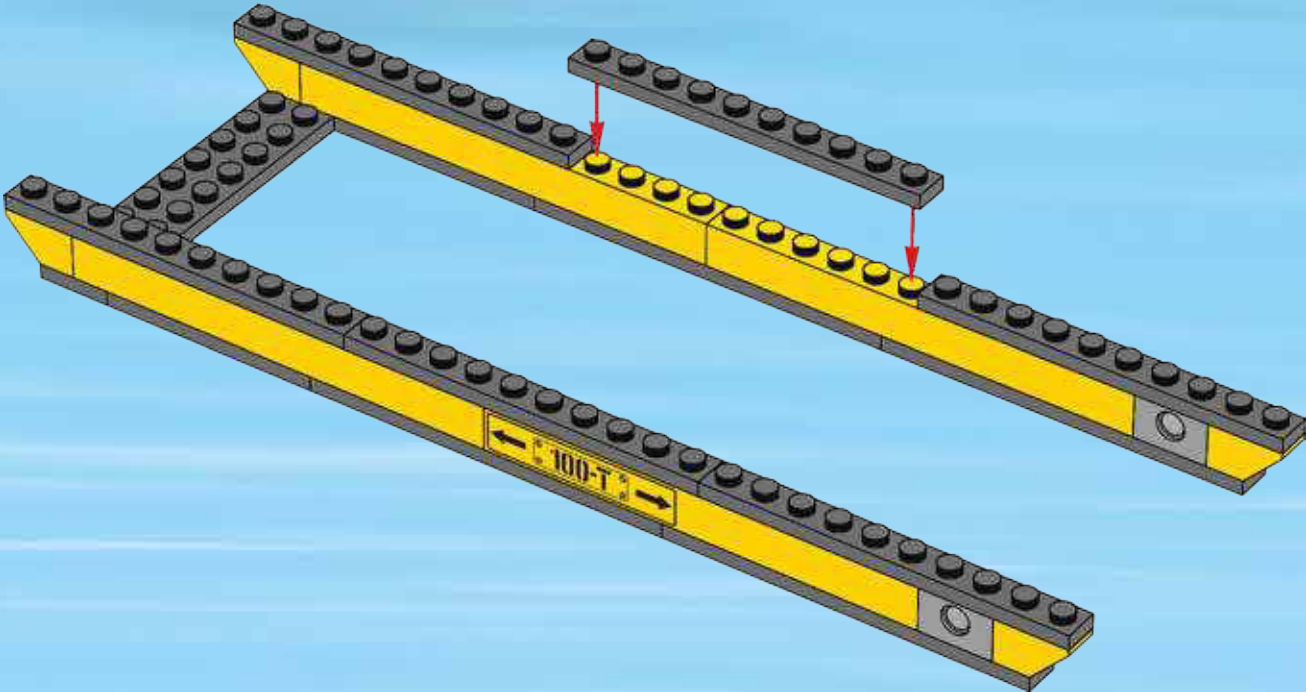

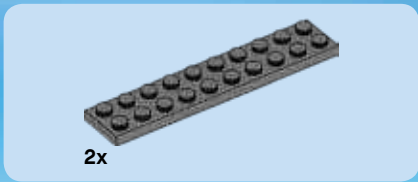

11

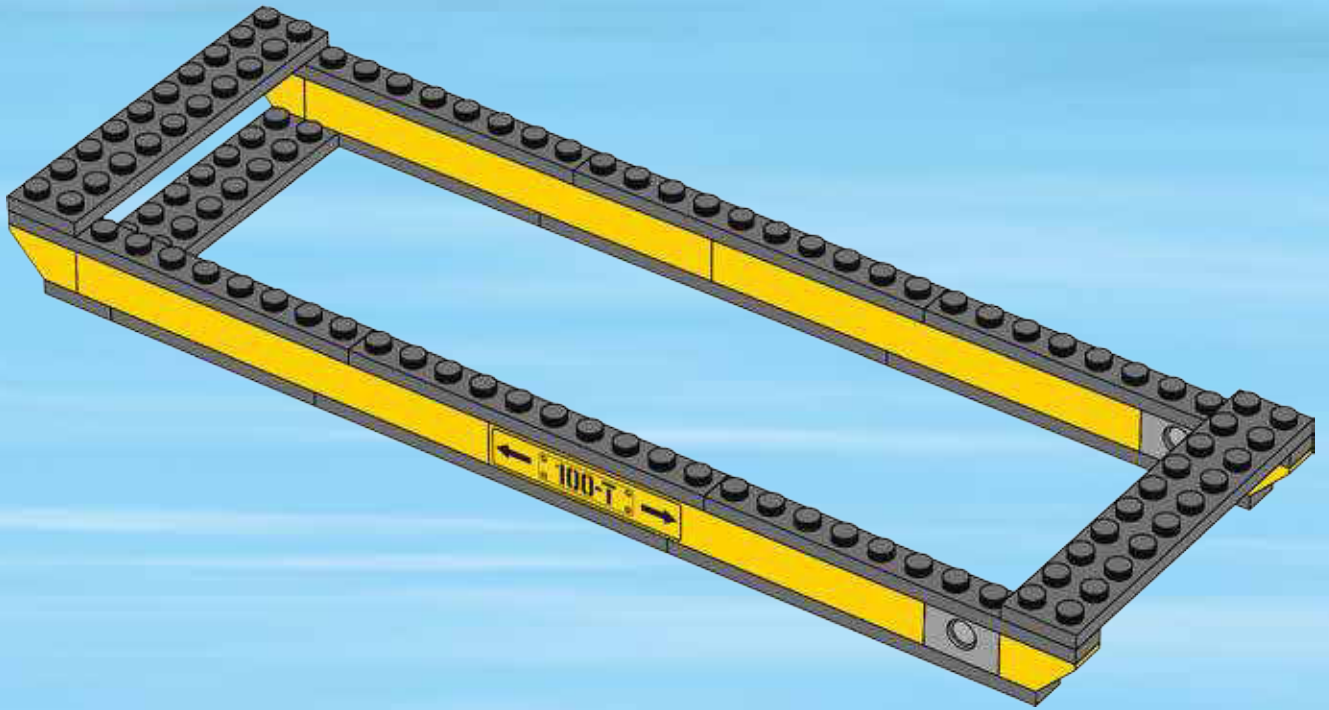

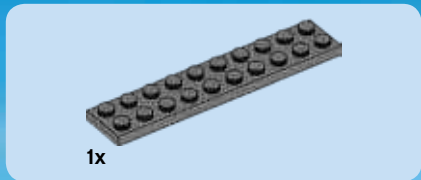

12



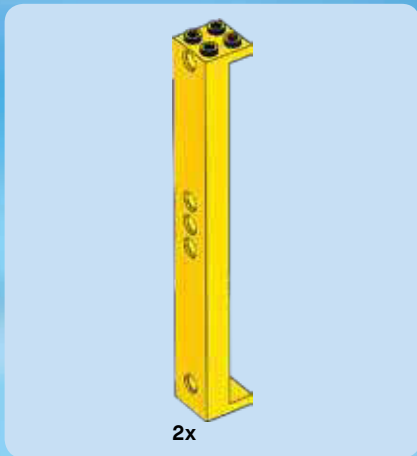

13



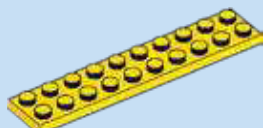

1x

14





4x

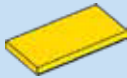

2x

15

1

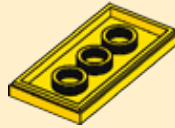

2

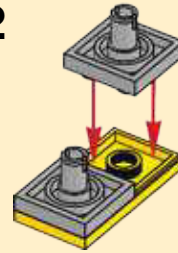

3



2x





4x



8x

16

1

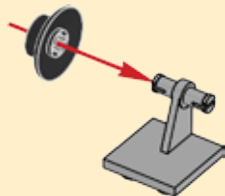

2



4x





2x

17

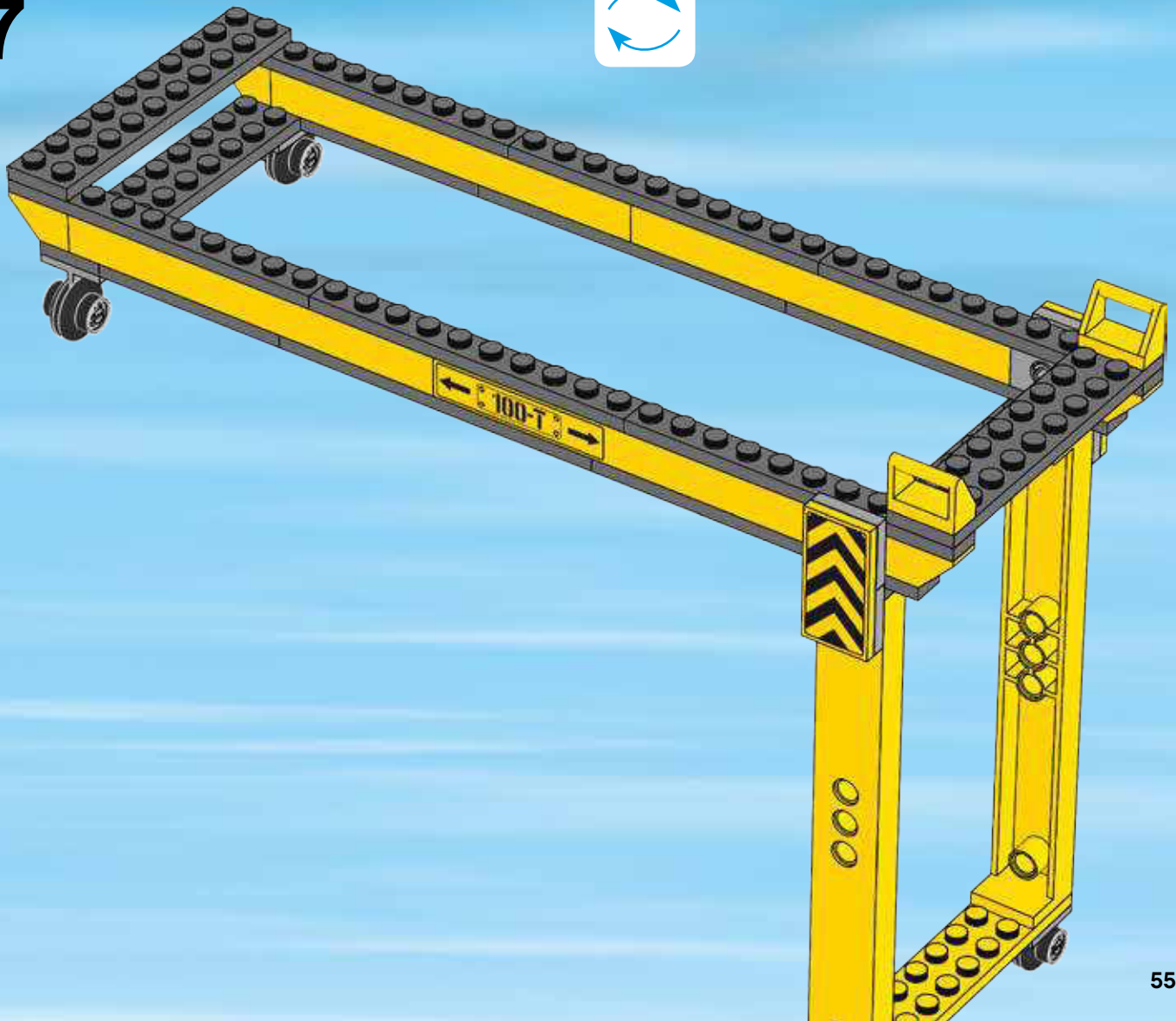



2x



2x

18

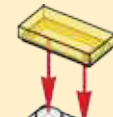

2x

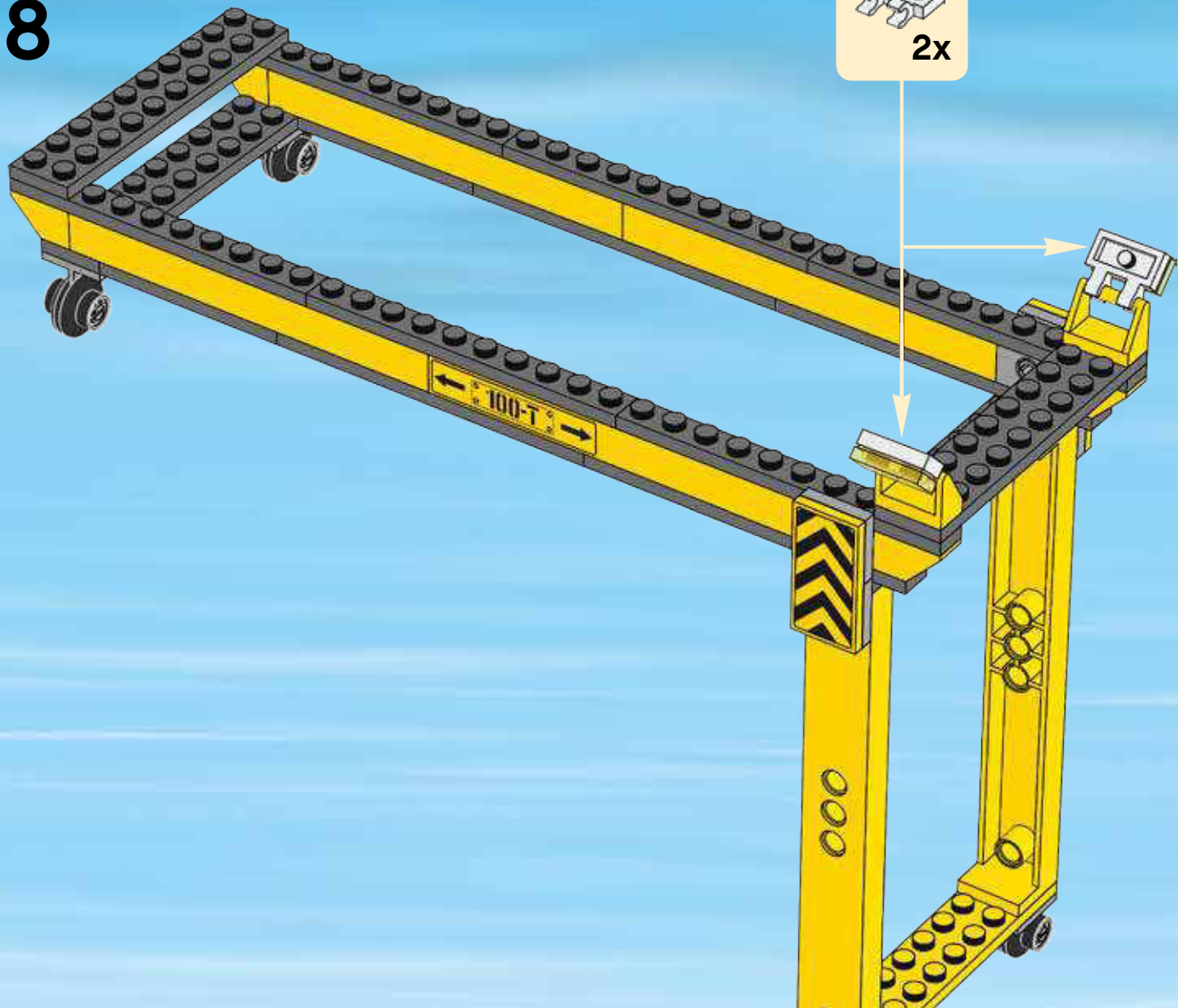

19

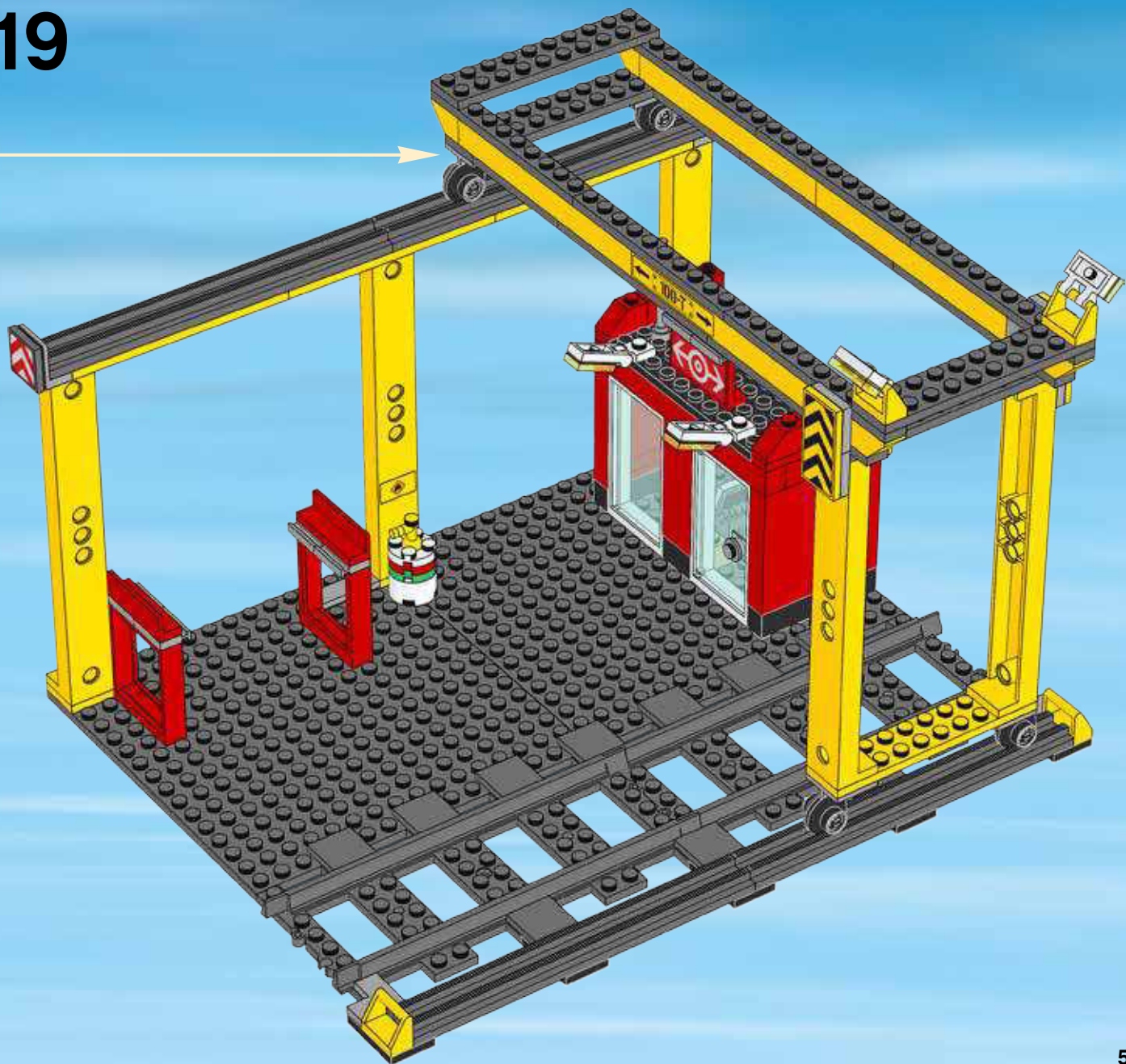



1x

1

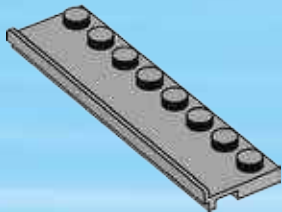

2x

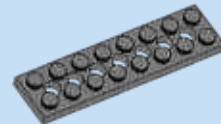

1x

2

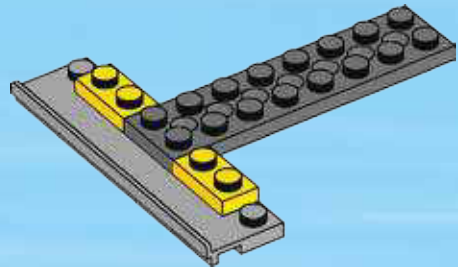



1x

3

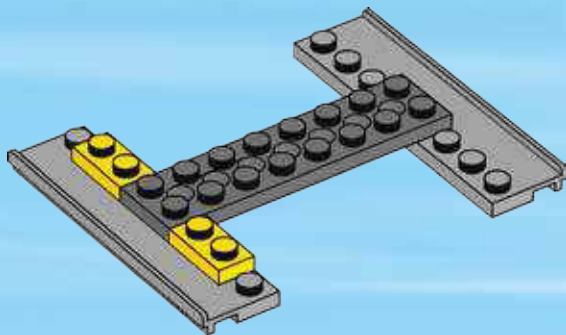

2x

4

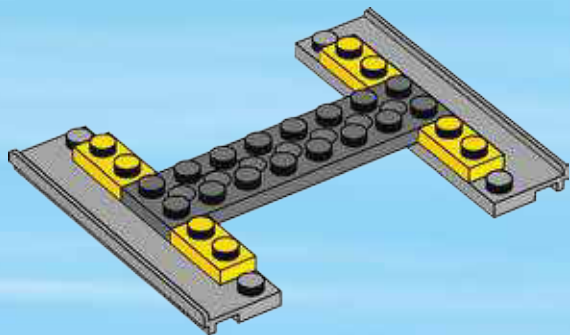



1x



1x

5

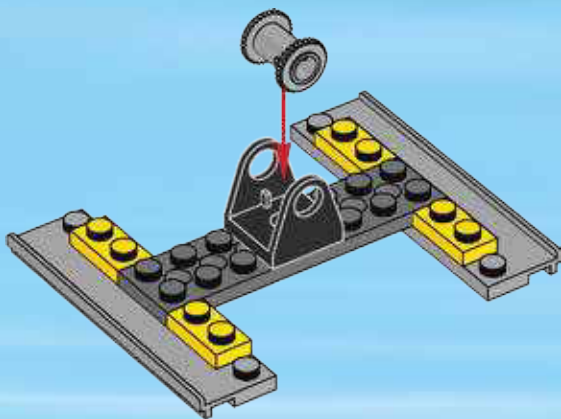

1x

6

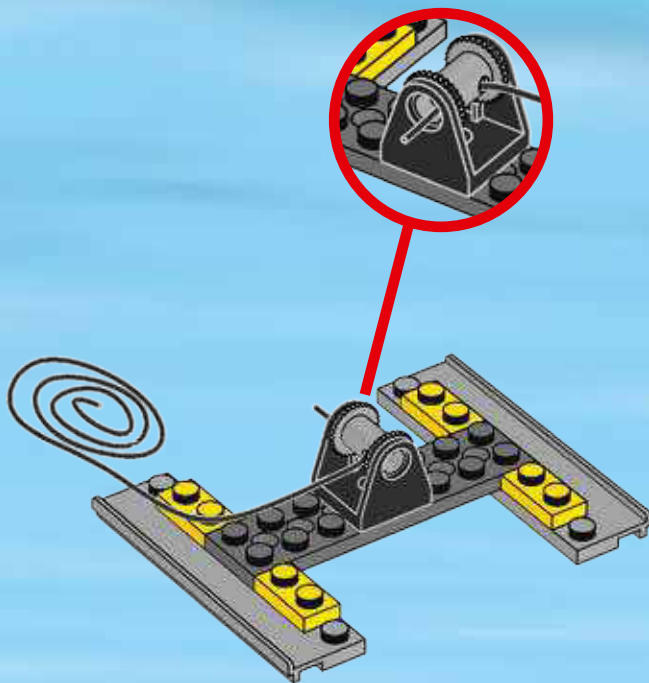



7

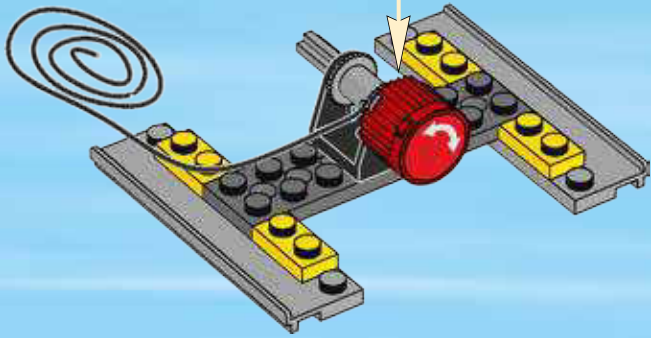
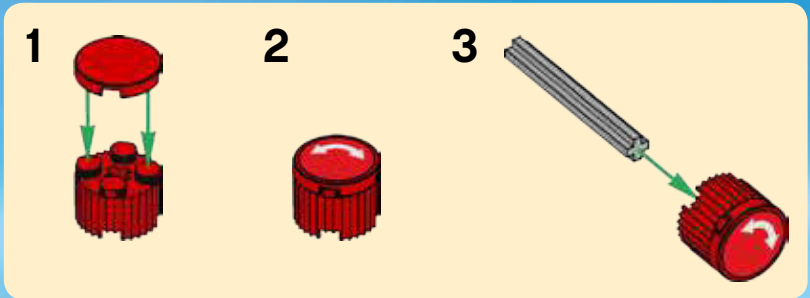



1x



1x

8

1



2

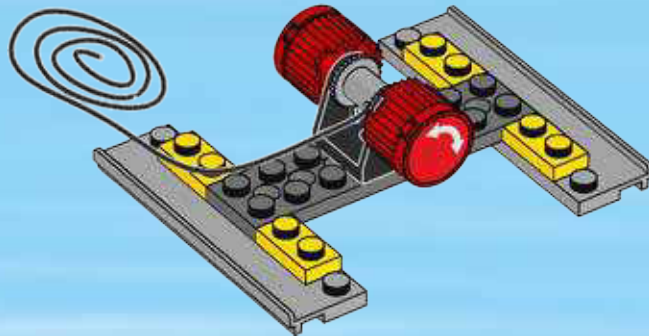

9

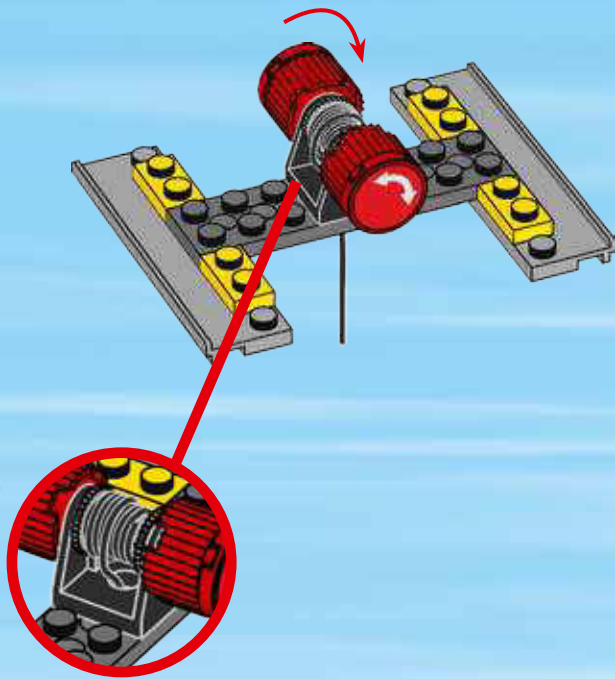

10

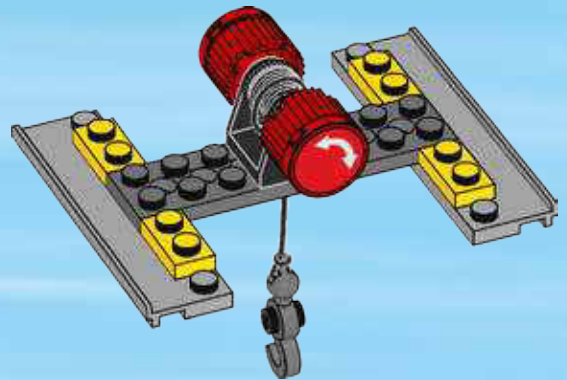
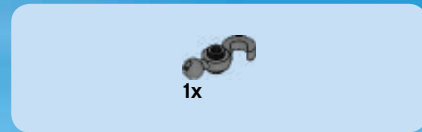

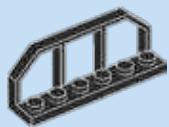

2x

11

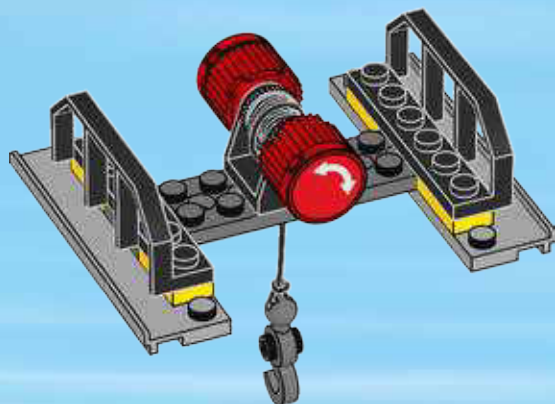

1x

12

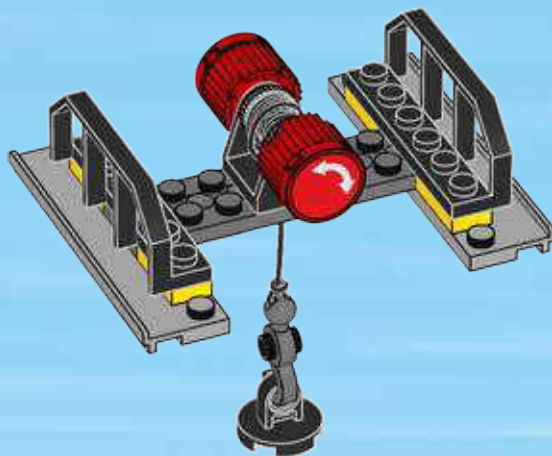

20

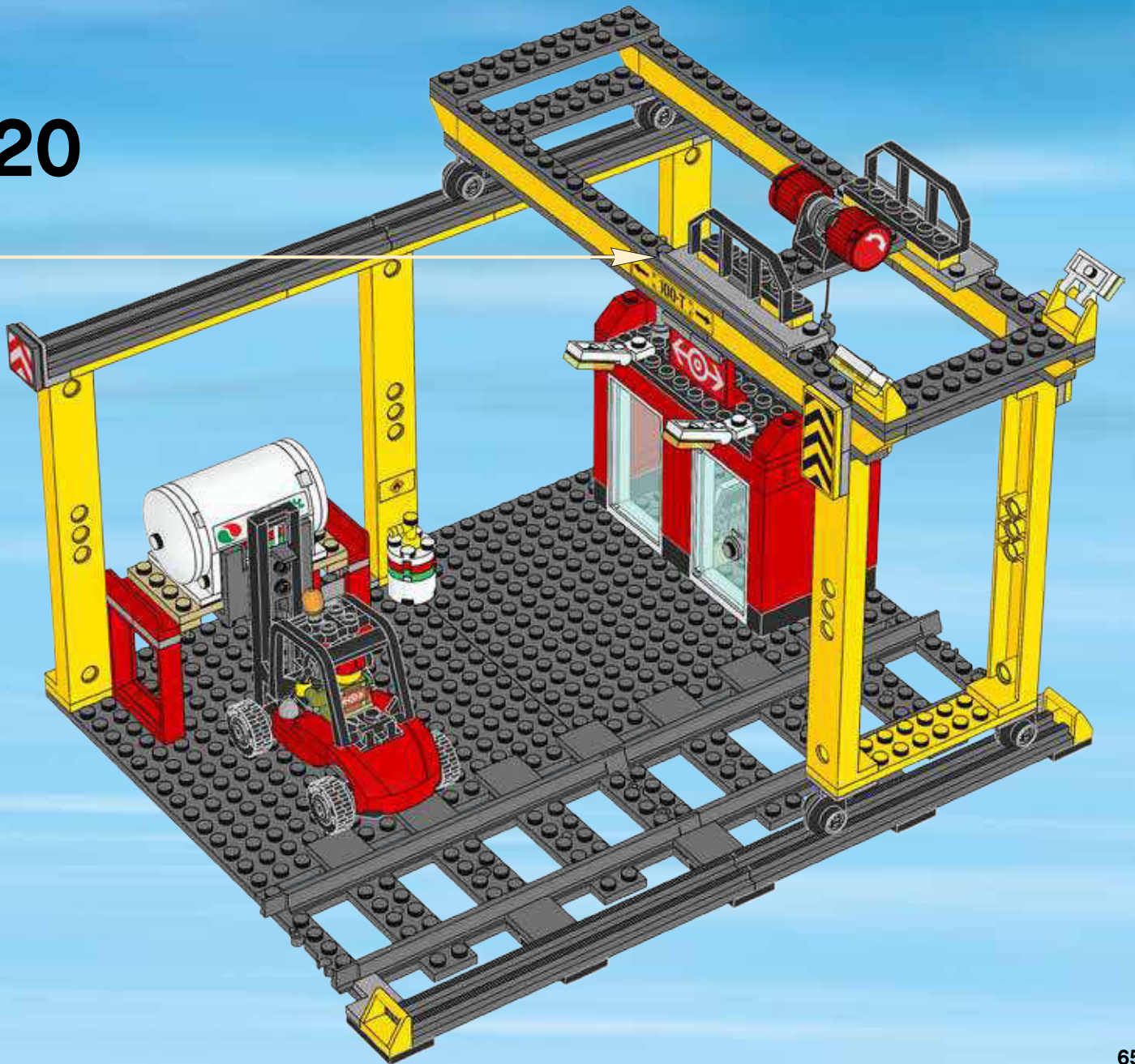



60104



60103



60102



60101



60100



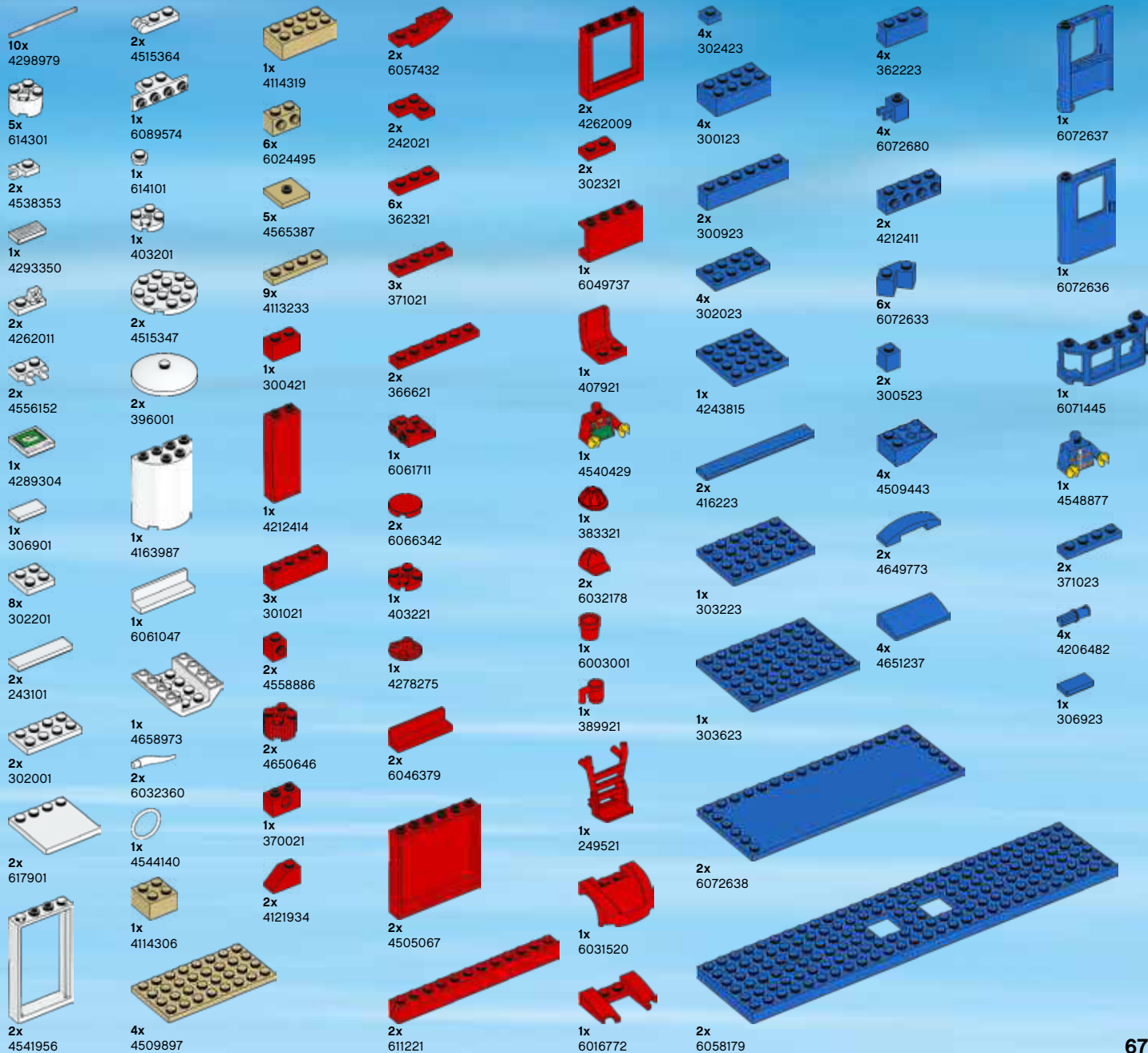



5x
6072694



3x
287724



3x
4164073



4x
4504381



4x
366524



4x
302324



3x
302224



4x
4251468



4x
383224

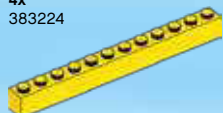

4x
4271082

68



1x
6021675



1x
6018620



1x
6022354



1x
4651443



1x
389924



2x
286624



8x
243224



1x
4256320



1x
407924



2x
4560181



5x
6051861



1x
6031790



4x
273026



2x
300426



1x
300226



4x
301026



3x
300126

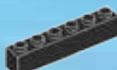

2x
300926



16x
4567436



2x
4548180



6x
6069000



4x
6053077



1x
4613153



4x
307026



1x
379426



2x
302326



3x
302226



4x
4558170



5x
302126



1x
371026



1x
302026

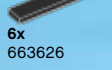

6x
663626



18x
4541191



1x
6035530



1x
4124096



1x
258426



8x
4621116



1x
4297719



1x
4140801



4x
4188953



13x
658326



2x
4140303



1x
6036006



1x
4516843



4x
4617848



4x
4568644



1x
249626



4x
6092658



2x
4217725



2x
73081



2x
4648117

8x
4515350



6x
366626



2x
617926



1x
4539385



8x
4295370



20x
4496343



10x
287826

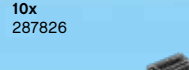

4x
4493326

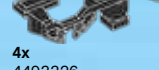

4x
4286009



2x
4589489



6x
4589495



2x
303426



2x
447726

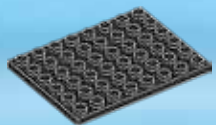

1x
303626

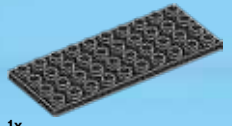

1x
303026

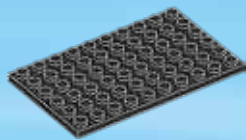

1x
303326

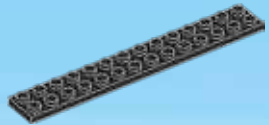

1x
6001494

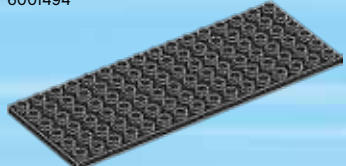

1x
302726

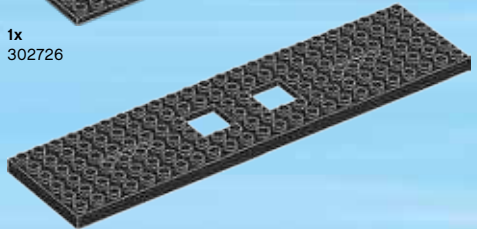

1x
6016487



8x
4517925



4x
4598528



4x
4107761



2x
4183043



2x
4183060



2x
6010831



1x
4531412

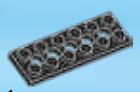

1x
3200126

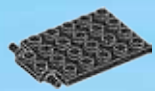

1x
6057903



1x
4567908

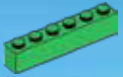

3x
4111844



2x
4187334



2x
4121969



2x
4142717



10x
302328



2x
371028



5x
366628



3x
370526

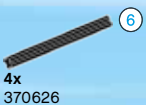

4x
370626



3x
4218868



1x
4584375



3x
379528



1x
403228



1x
4567914



1x
4567918



1x
4626650



1x
74040



1x
6032177



1x
6072605



1x
4503291



4x
6022880



2x
4244362



3x
3005740



2x
3000841



2x
3005741



4x
4542673



1x
4524365



3x
4529685



1x
4520810



1x
6063576



1x
6022905



1x
4520866



2x
6074032

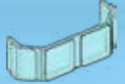

1x
6080721

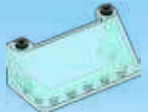

1x
4599455



4x
4194535



1x
4626884



2x
6076153



1x
4162916



1x
4654448

5x
6020073

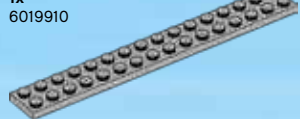
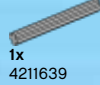
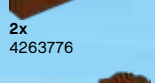
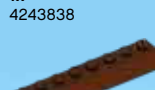
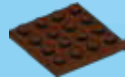

2x
4211486

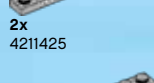
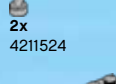
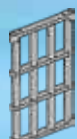

2x
4222019



1x
4212529

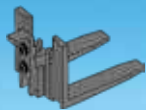

1x
6058407

1x
4211066



1x
4638959

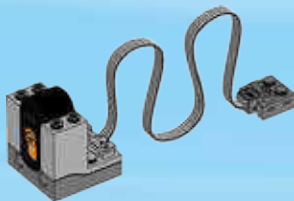

1x
6040157

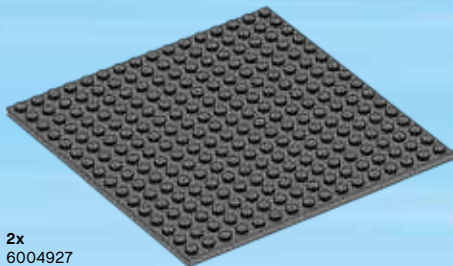

2x
6004927

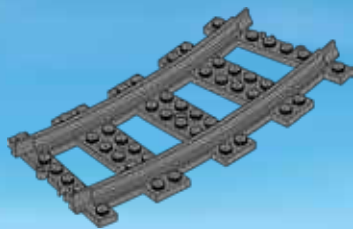

20x
4279717

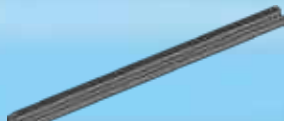

8x
4638990

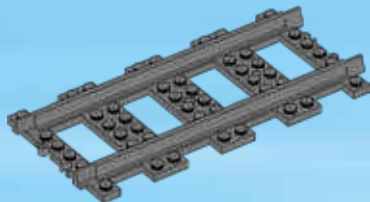

8x
6070018

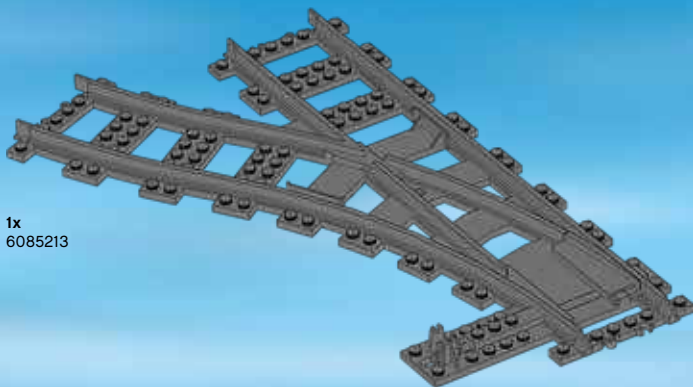

1x
6085213

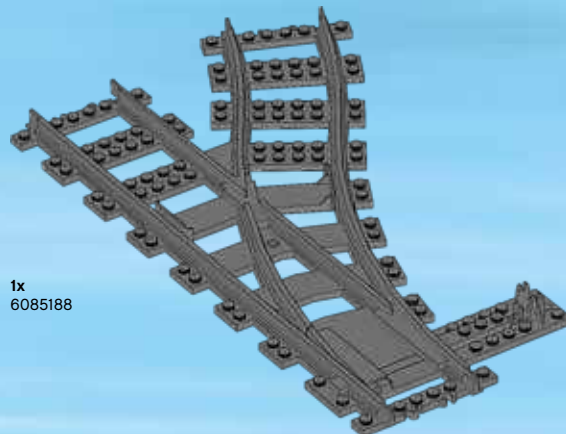

1x
6085188

Customer Service
Kundenservice
Service Consommateurs
Servicio Al Consumidor

LEGO.com/service or dial



: 00800 5346 5555

: 1-800-422-5346





All your LEGO® fun in one app



Minifigure yourself



Share



Create



For ages 5-9
适合 5-9 岁儿童

Download on the
App Store

GET IT ON
Google play

LEGO, the LEGO logo, the Minifigure, the Brick and Knob configurations and the LIFE logo are trademarks of the LEGO Group. ©2014, 2016, 2017 The LEGO Group. 6201483

Check availability of LEGO LIFE in your country now on LEGO.com/life
Ask parents' permission first.

Controlla la disponibilità di LEGO LIFE nel tuo paese su LEGO.com/life
Chiedere prima il permesso ai genitori.

Apple and the Apple logo are trademarks of Apple Inc., registered in the U.S. and other countries. App Store is a service mark of Apple Inc. Google Play is a trademark of Google Inc.

Auf LEGO.com/life erfährst du jetzt, ob LEGO LIFE in deinem Land verfügbar ist
Bitte frage erst deine Eltern um Erlaubnis.

Consulta si LEGO LIFE está disponible en tu país en LEGO.com/life
Pide antes permiso a tus padres.

Ellenőrizd a LEGO LIFE elérhetőségét a lakóhelyeden, most a LEGO.com/life honlapon!
Először kérj engedélyt a szüleidtől!

Vérifie la disponibilité de LEGO LIFE dans ton pays sur LEGO.com/life
Demande d'abord l'autorisation d'un parent.

Verifica agora a disponibilidade de LEGO LIFE no teu país em LEGO.com/life
Pede primeiro permissão aos teus pais.

访问 LEGO.com/life 网站, 查看乐高生活系列是否已在你在国家上线。先请求家长的许可。