



# Disney

10776





Check for compatibility  
Kompatibilität prüfen  
Vérifier la compatibilité  
Controlla la compatibilità  
Comprueba tu compatibilidad  
Verificar a compatibilidade  
Ellenőrizd a kompatibilitást  
Pārbaudīt saderību  
检查兼容性

[LEGO.com/devicecheck](https://LEGO.com/devicecheck)

# 乐高®拼搭指引



LEGO® Building Instructions



Download on the  
App Store



GET IT ON  
Google Play



腾讯应用宝  
安卓应用商店

Apple and the Apple logo are trademarks of Apple Inc.  
Google Play and the Google Play logo are trademarks of Google LLC.  
Tencent and the Tencent logo are trademarks of Tencent Inc.





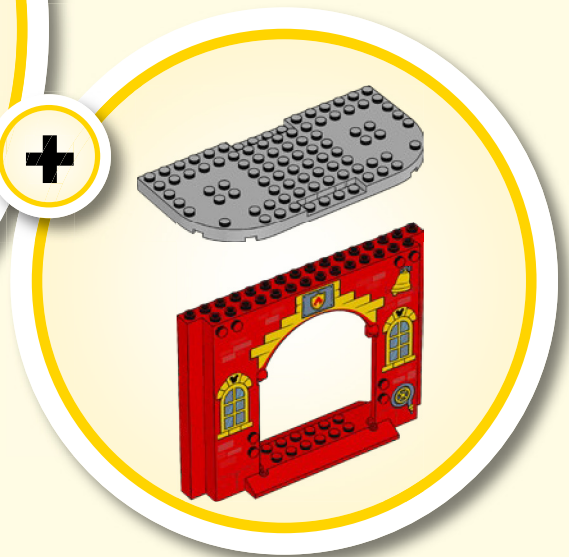

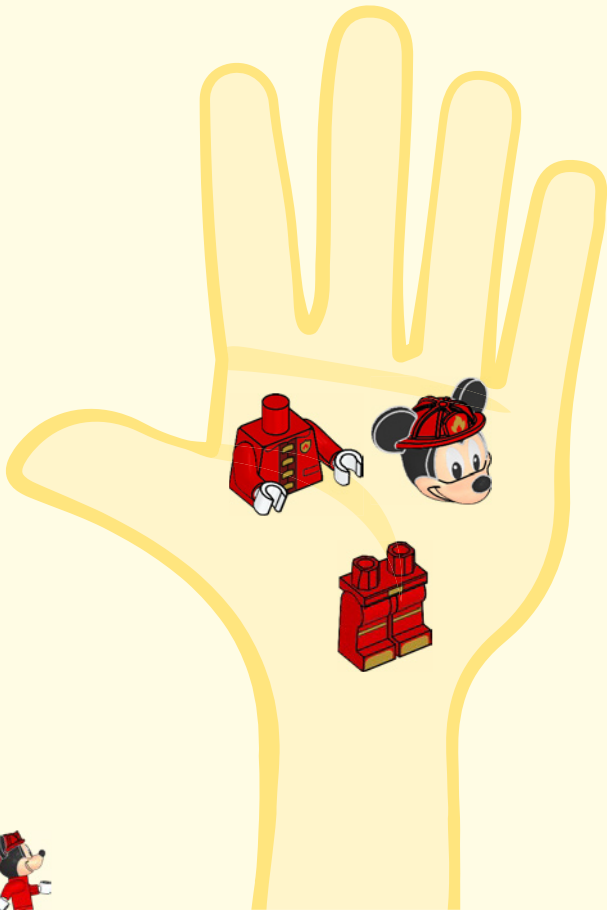
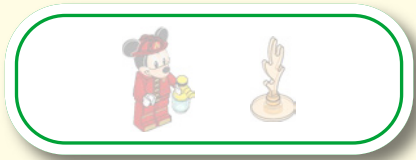

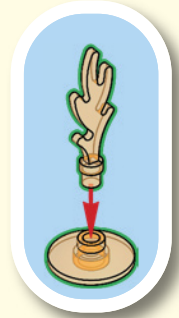
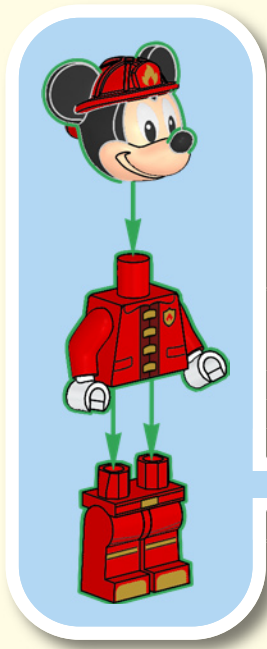

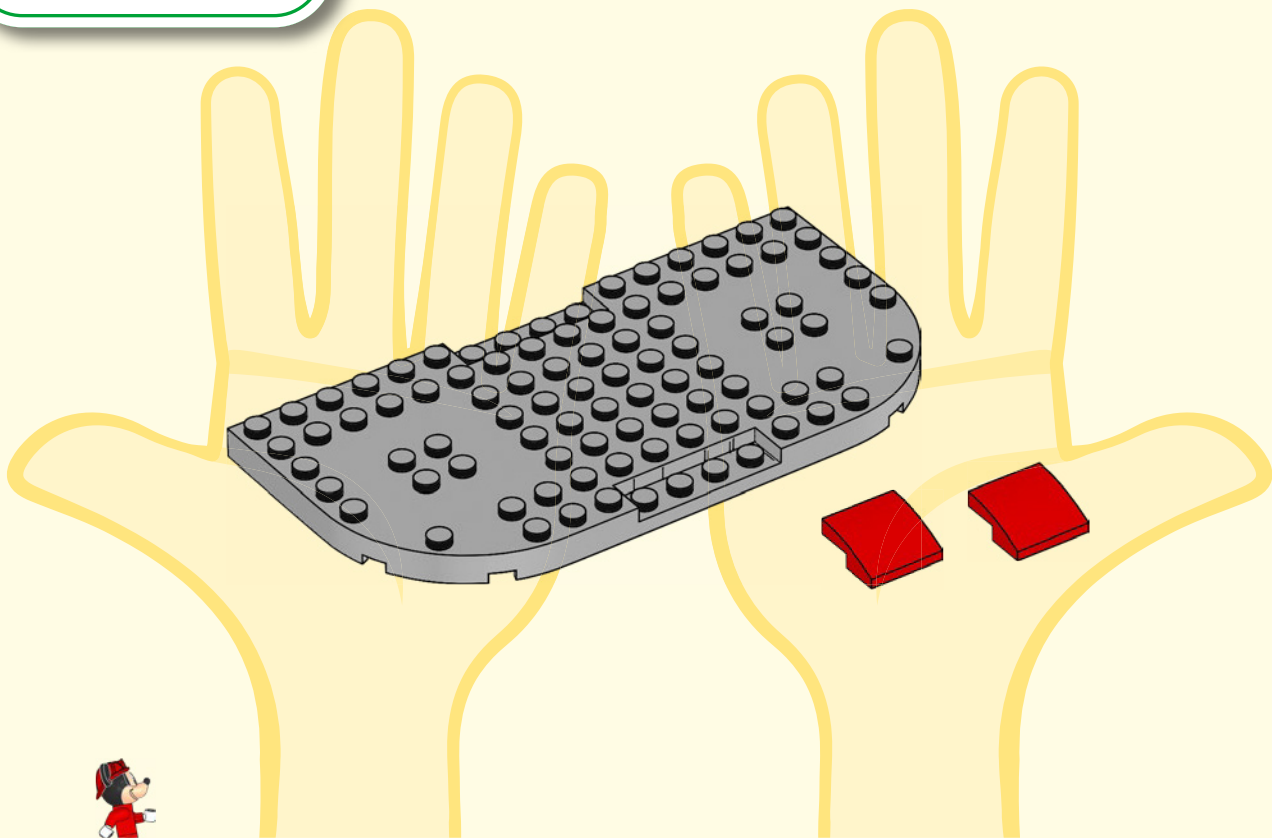
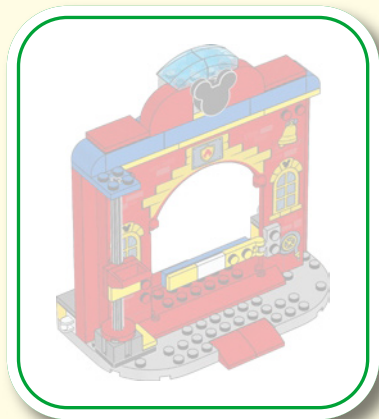



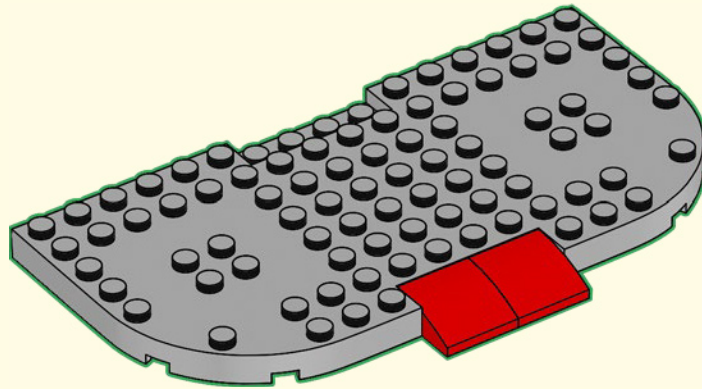

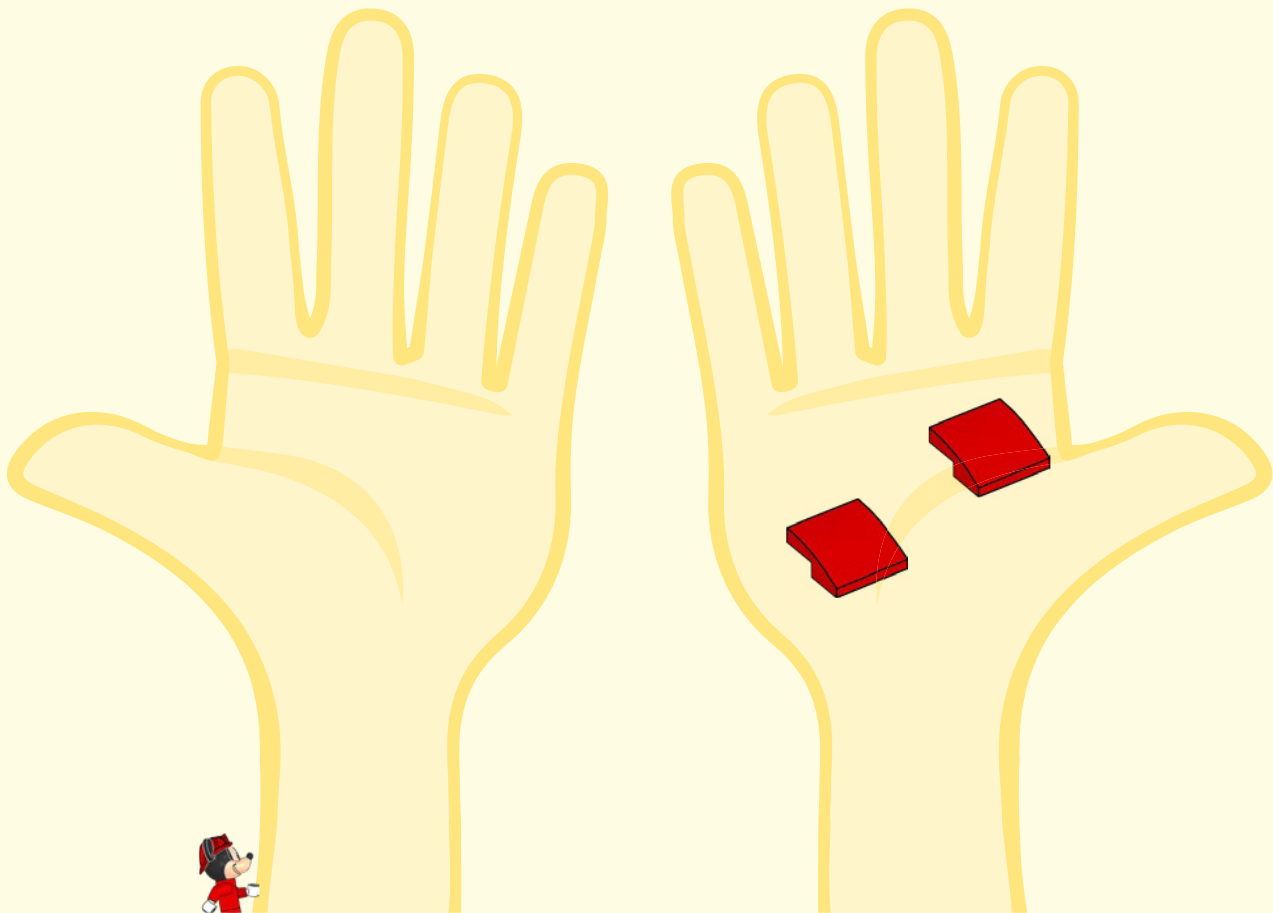

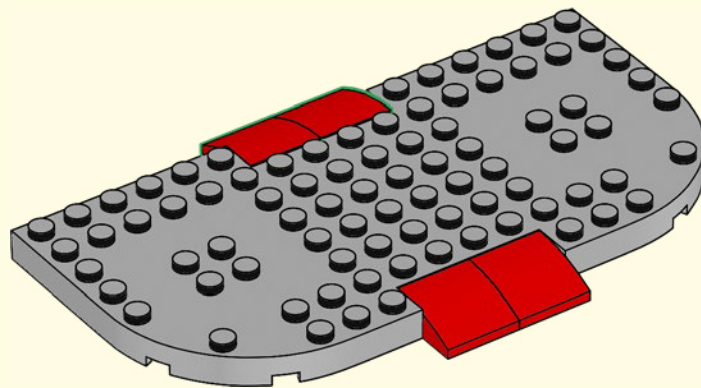

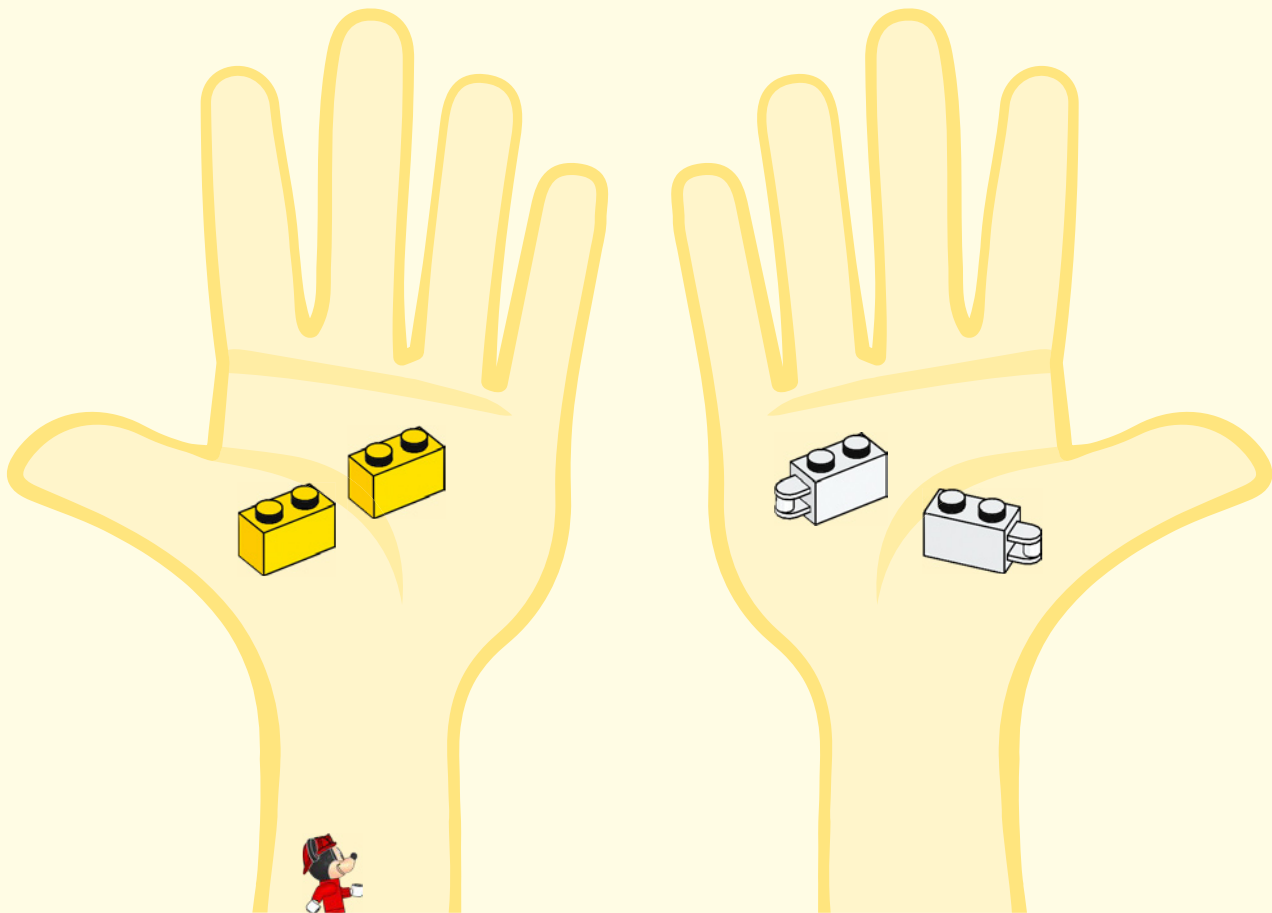

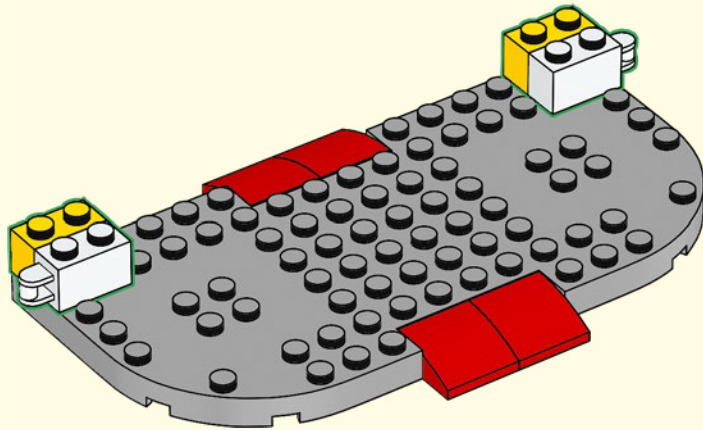

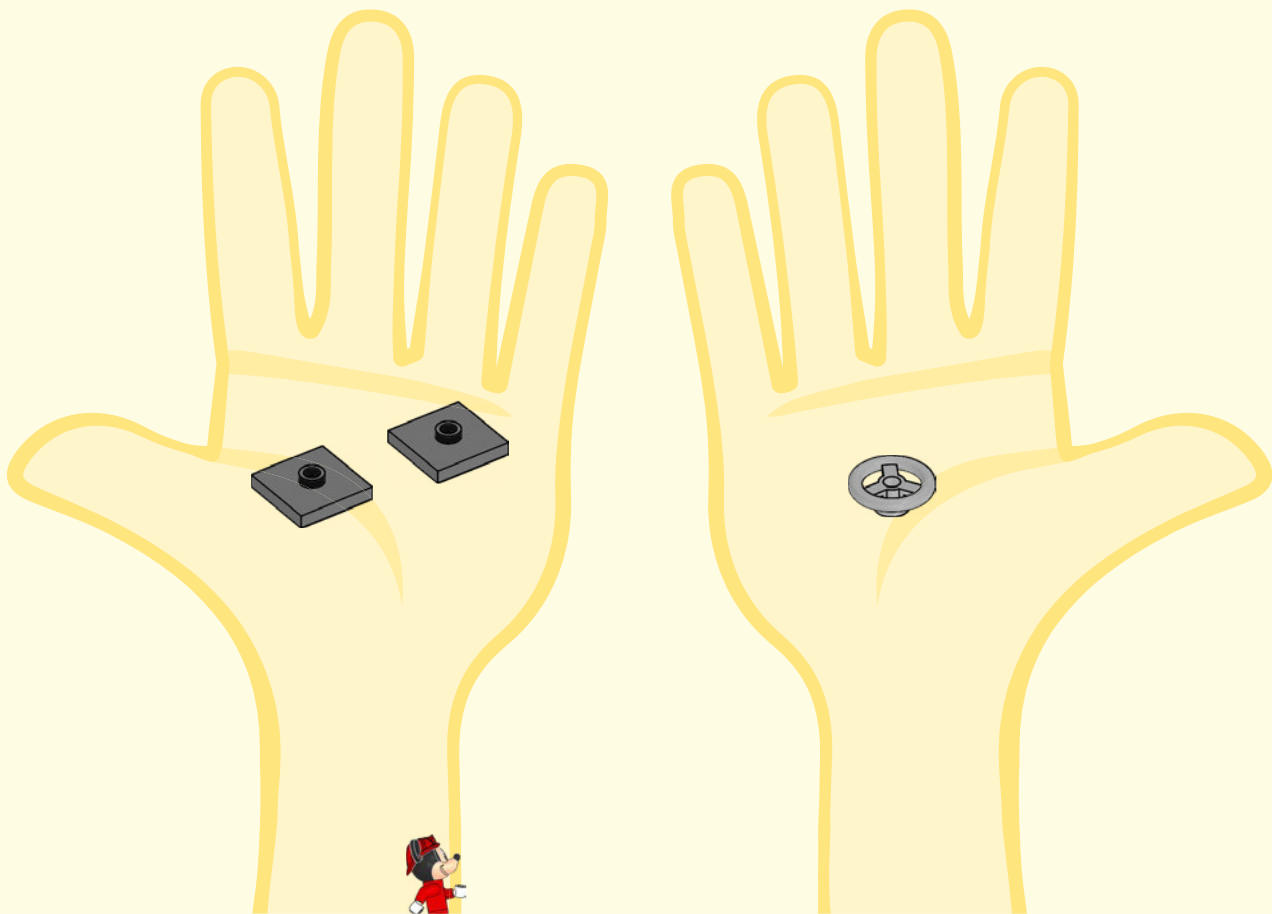

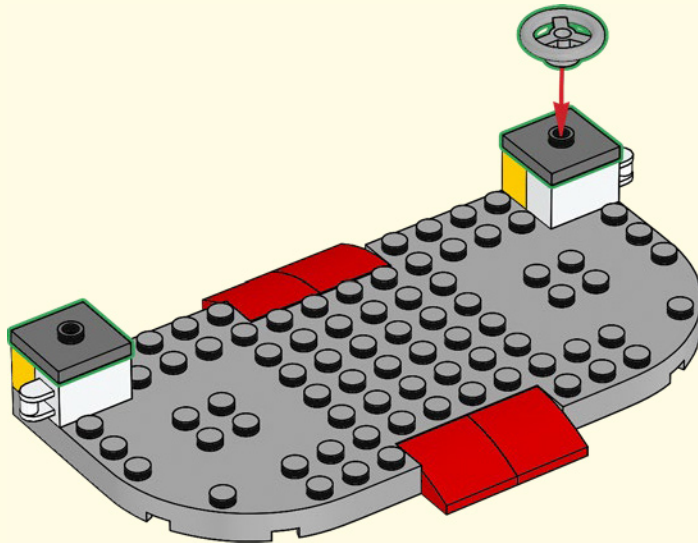

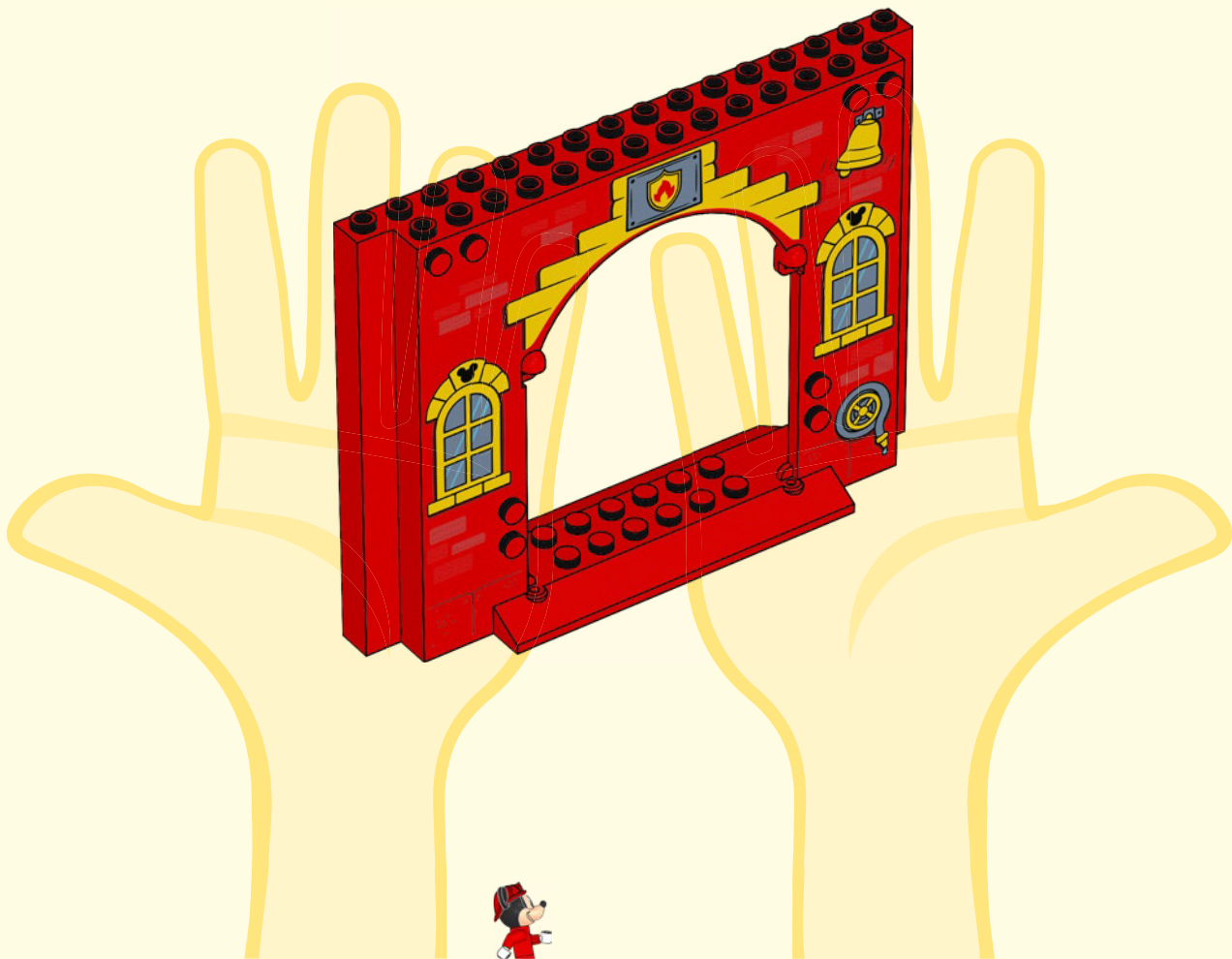



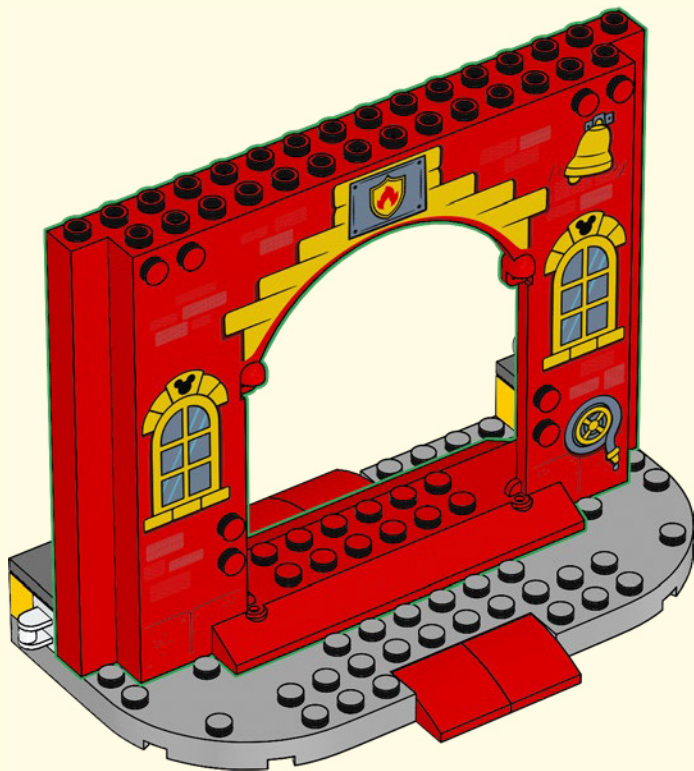

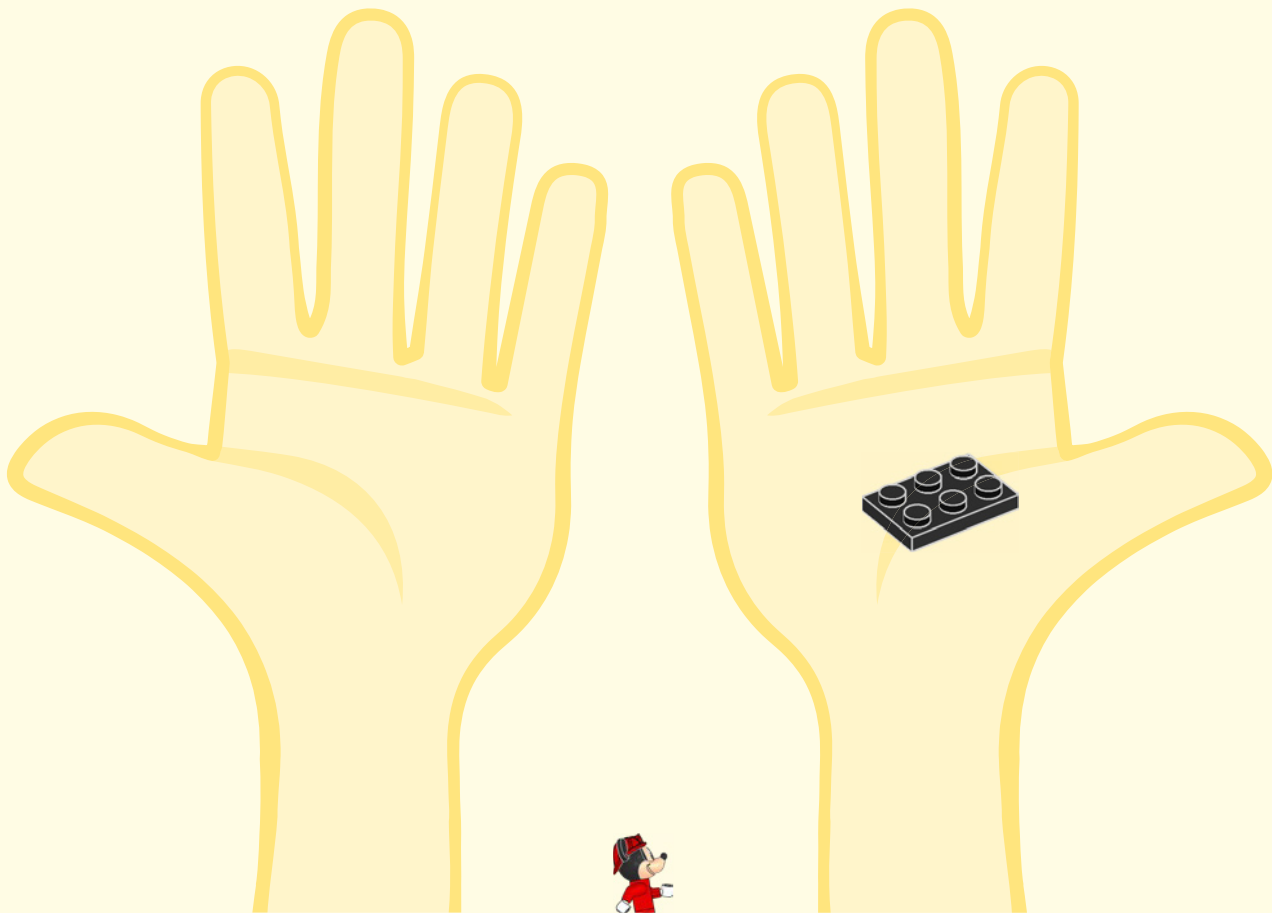

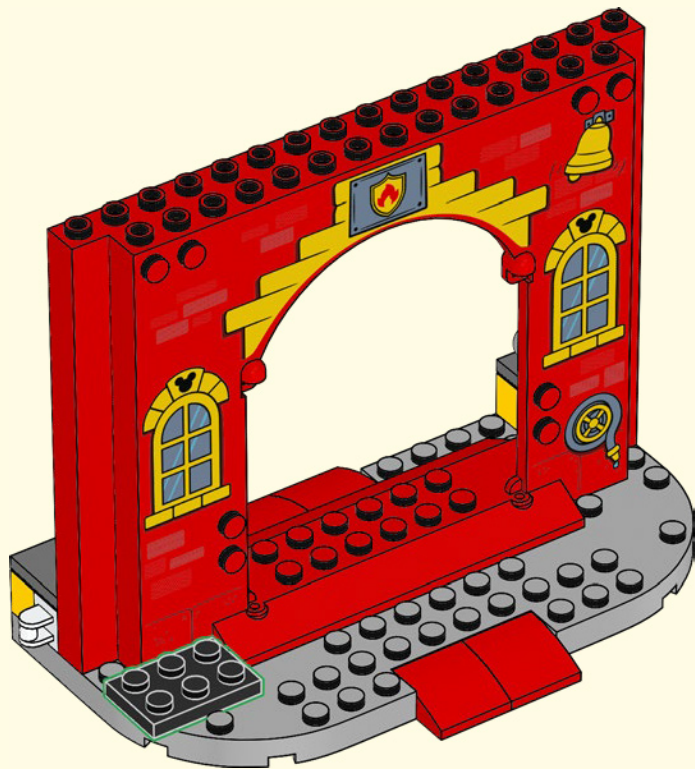

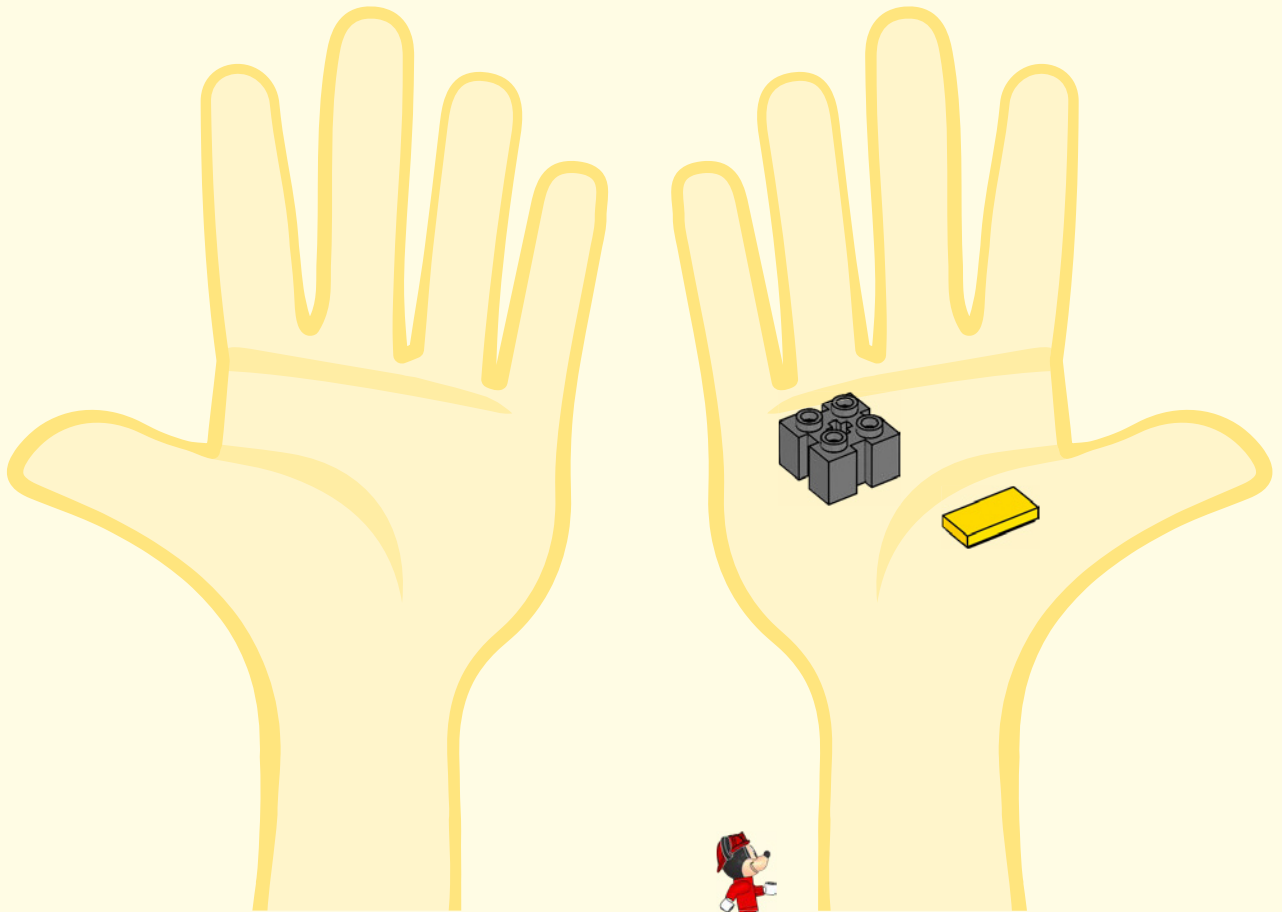

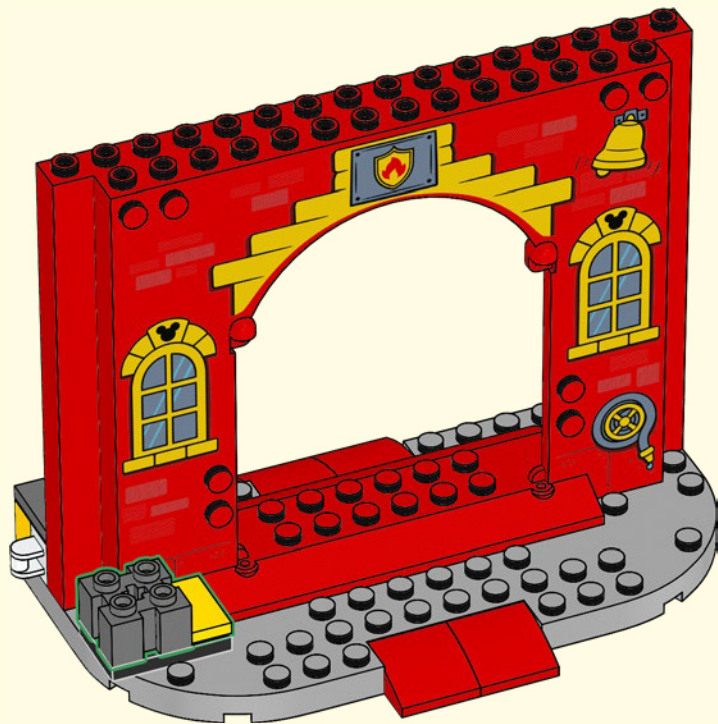

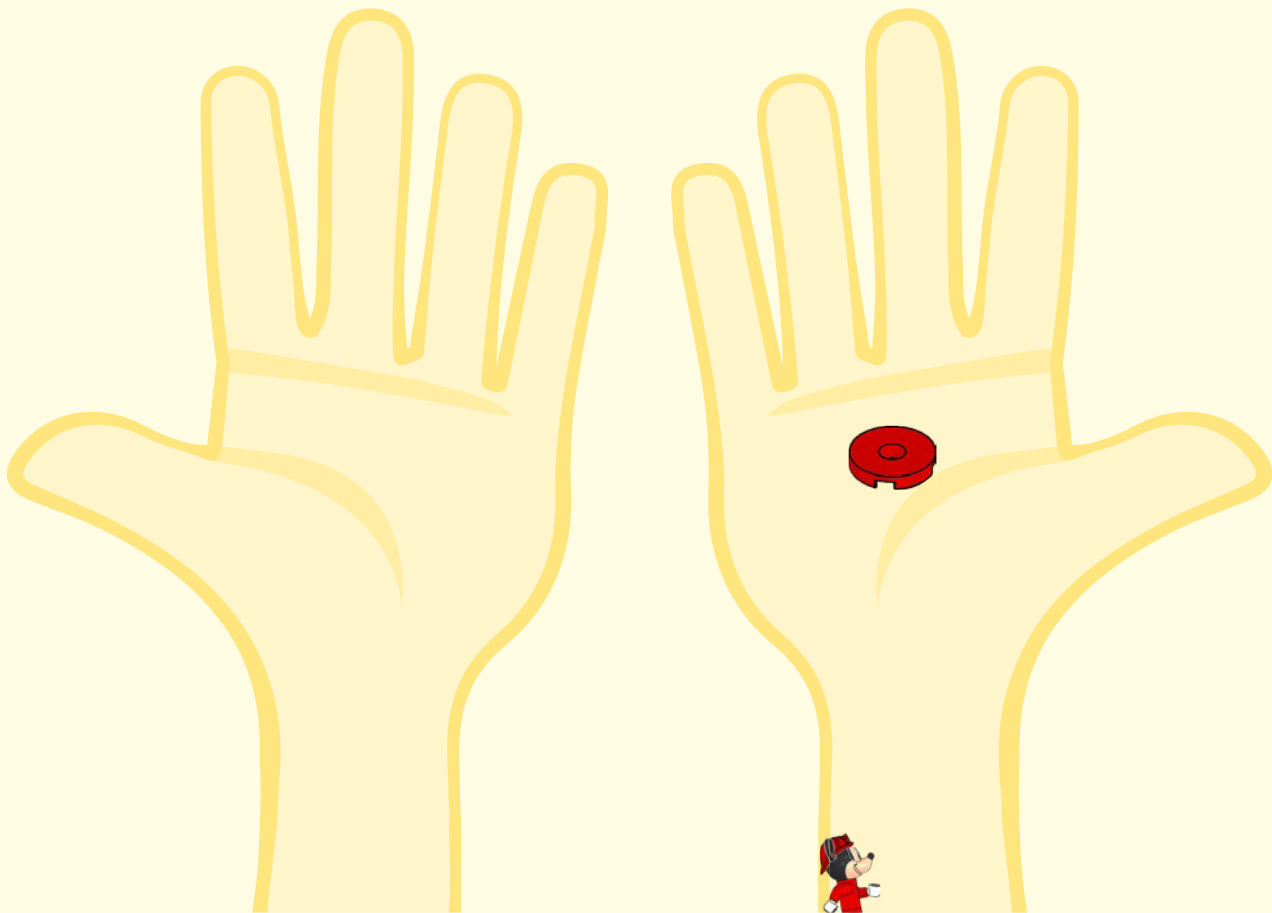

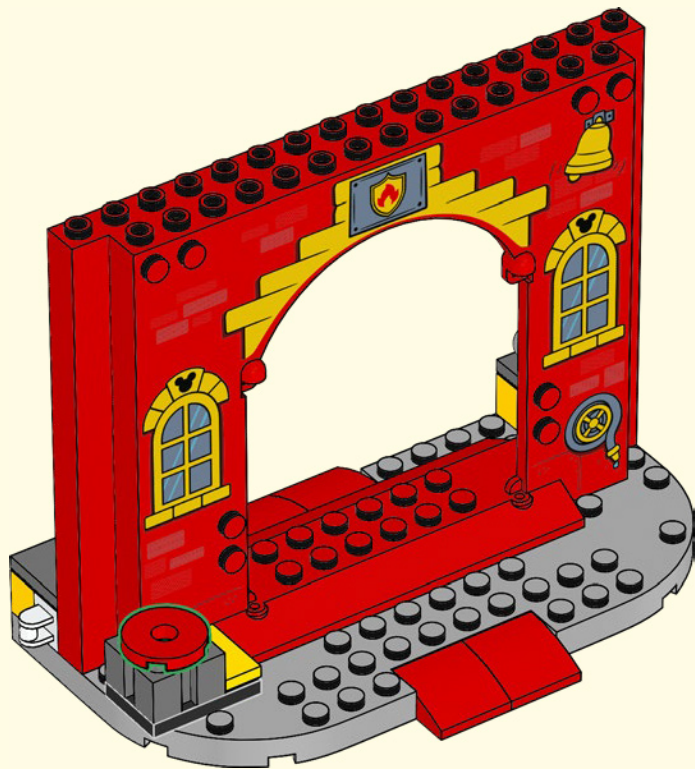

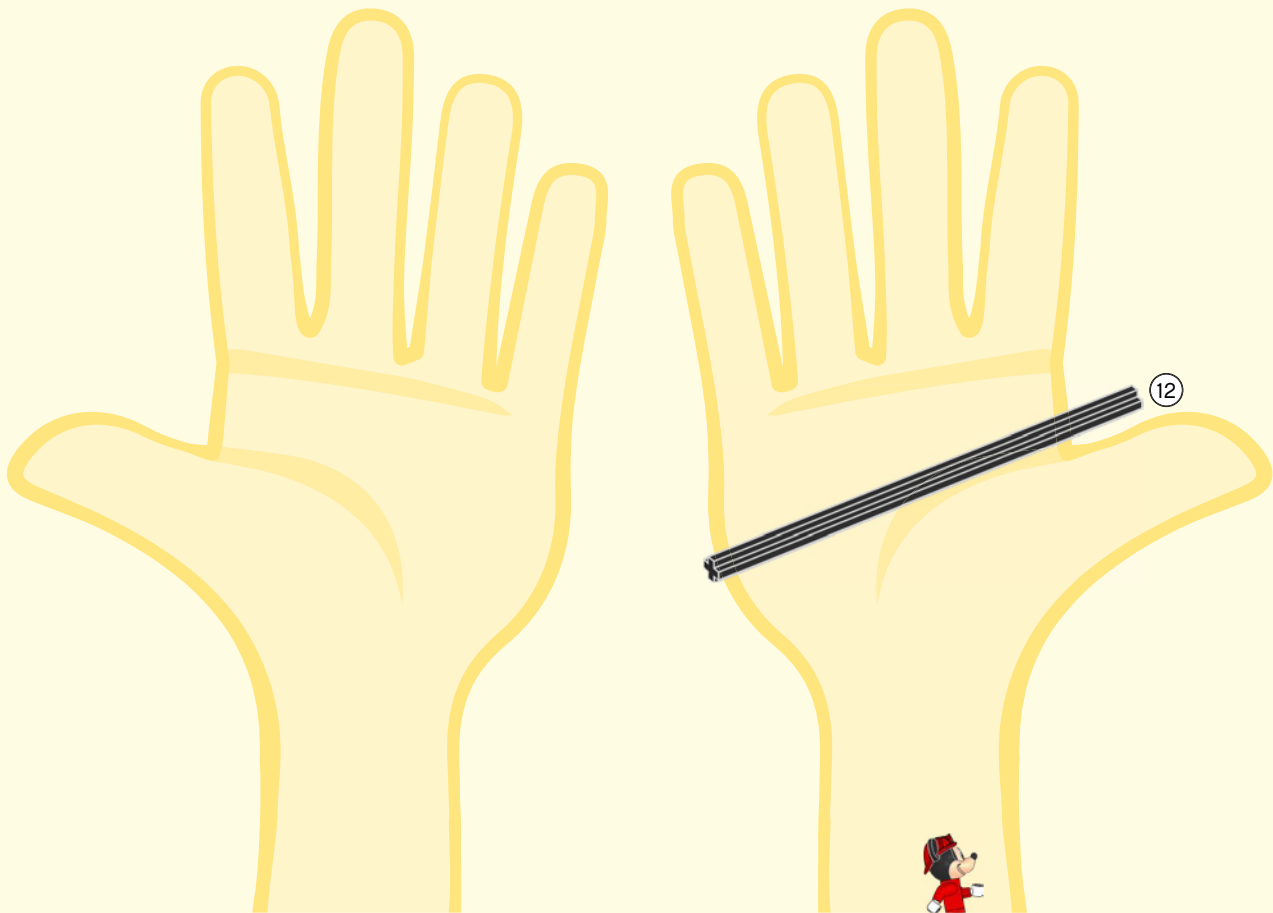



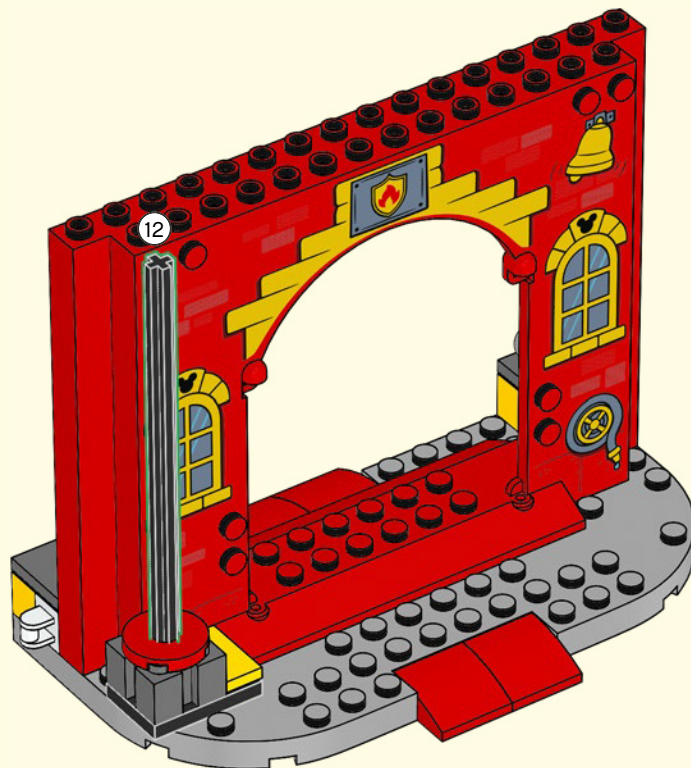

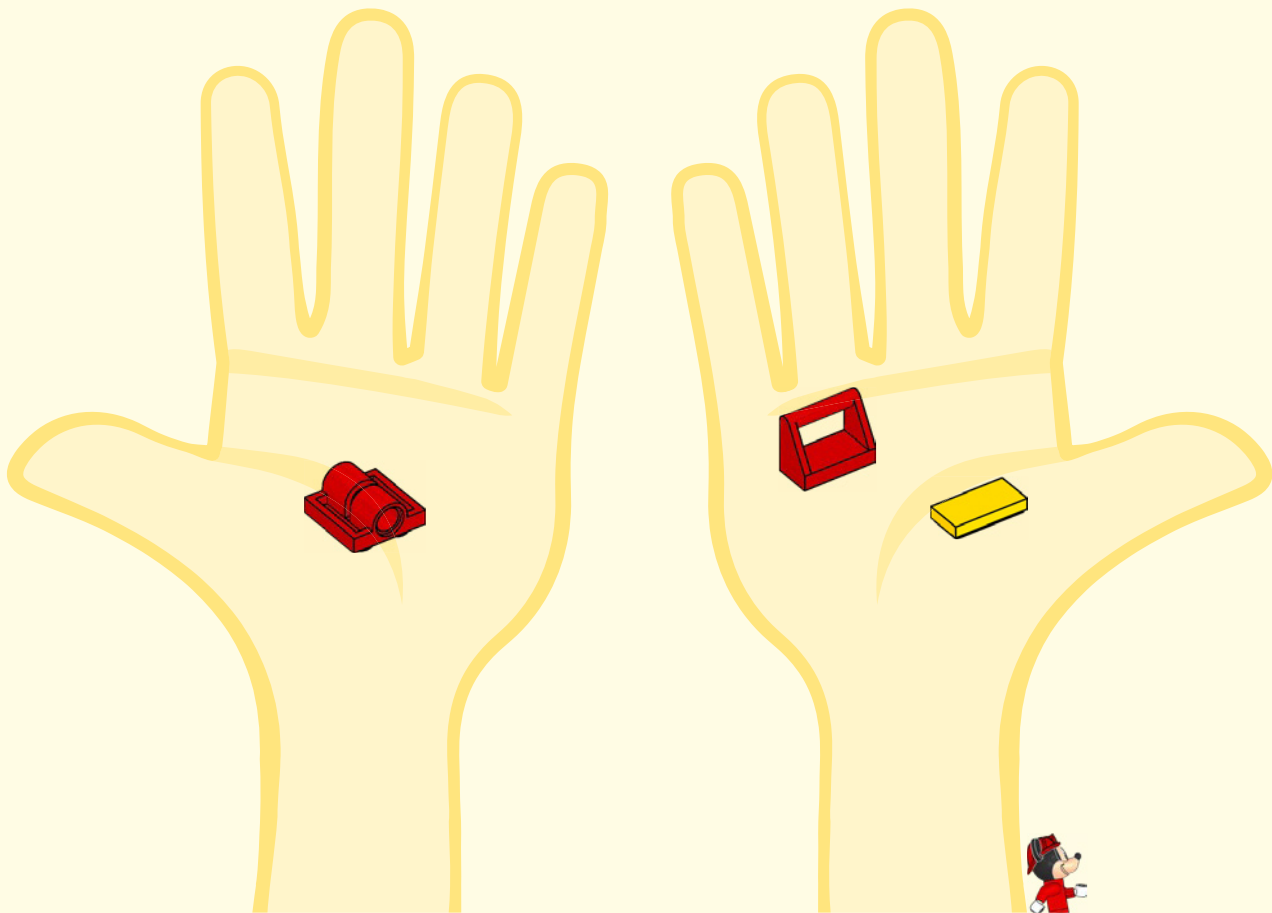

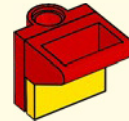

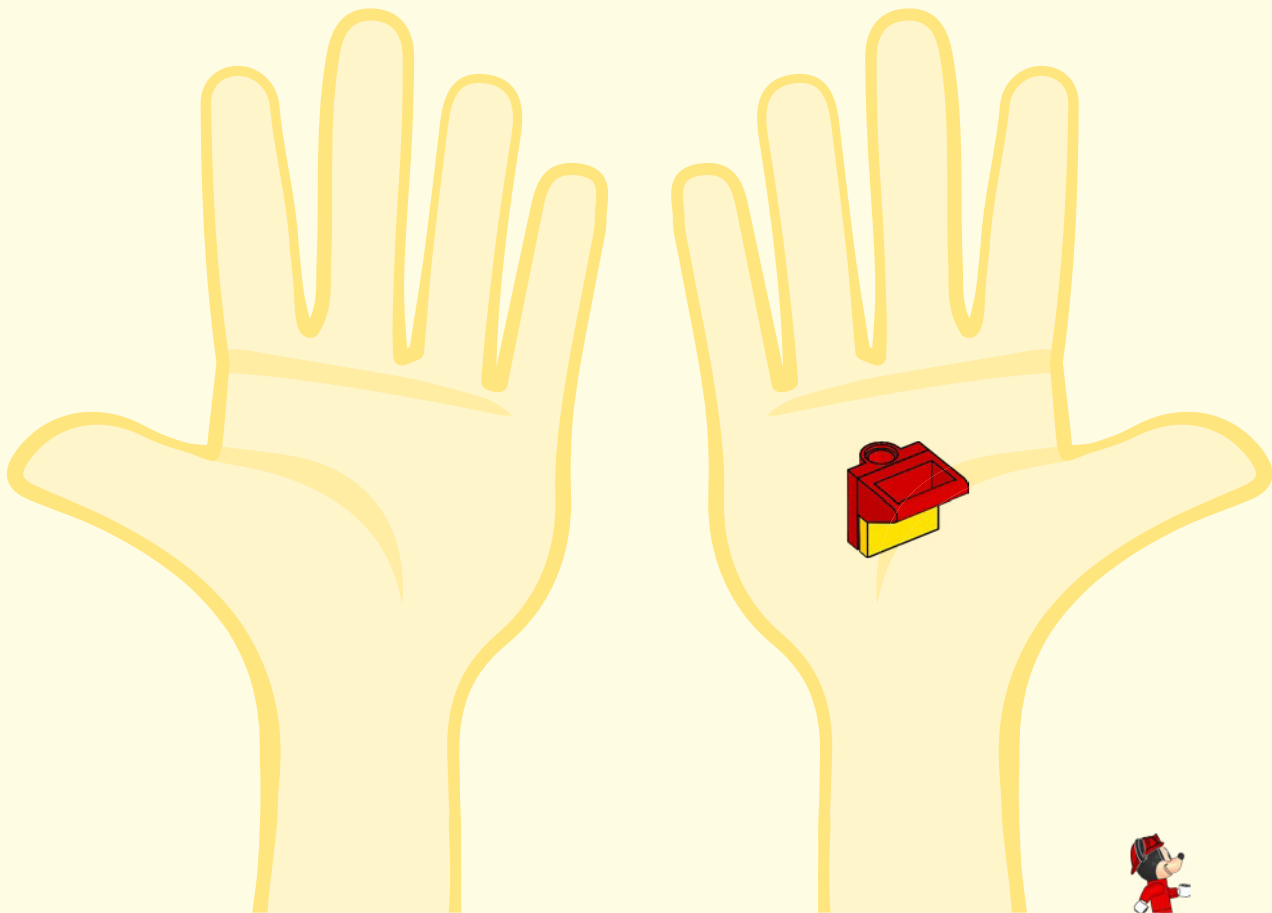

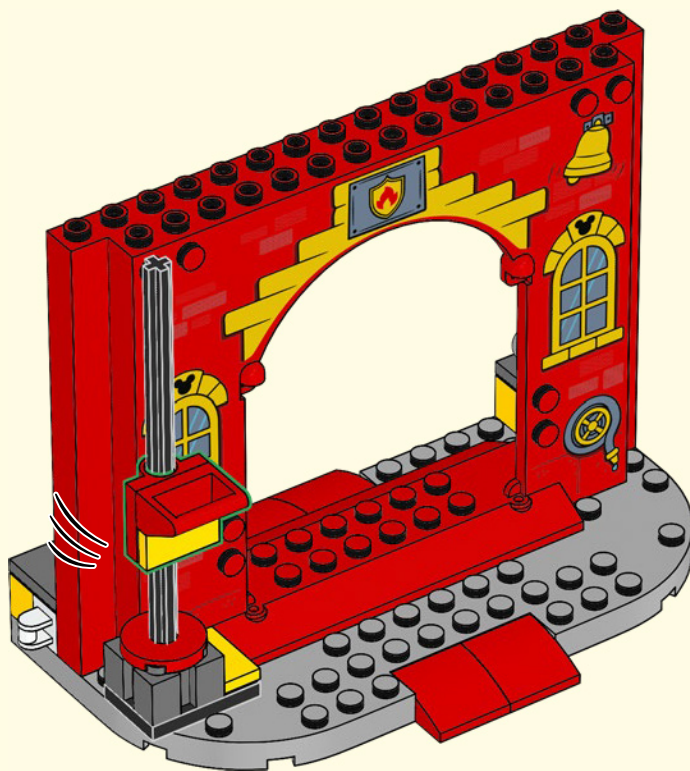

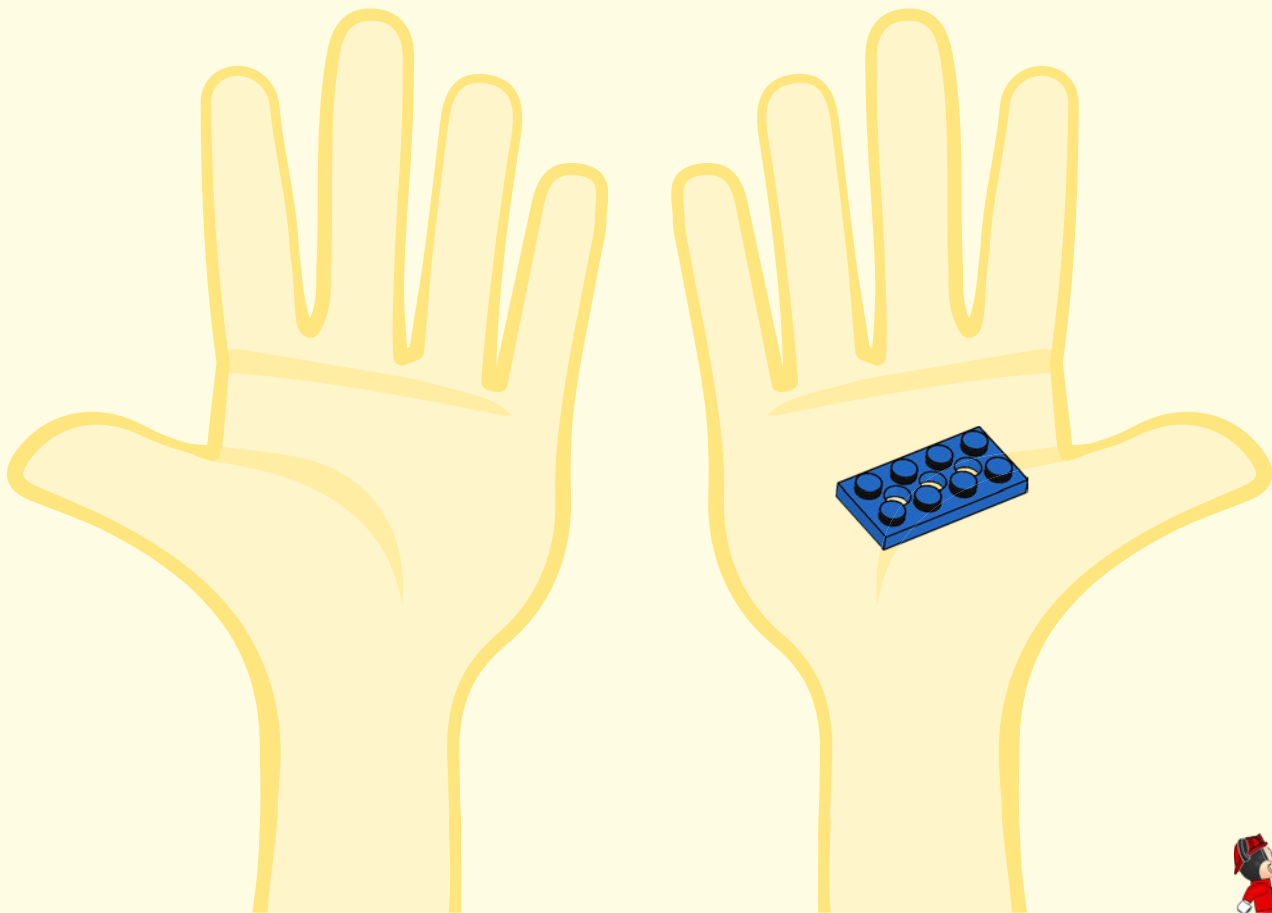

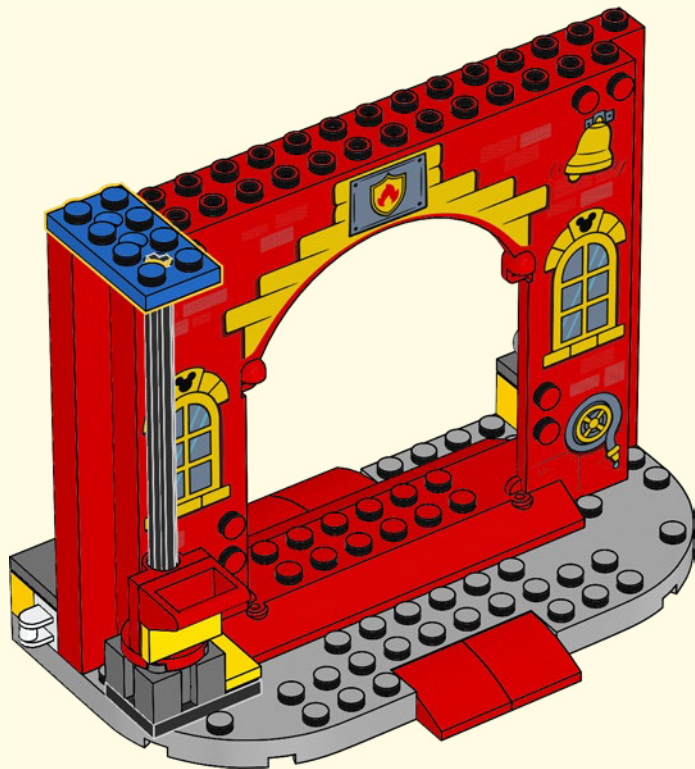

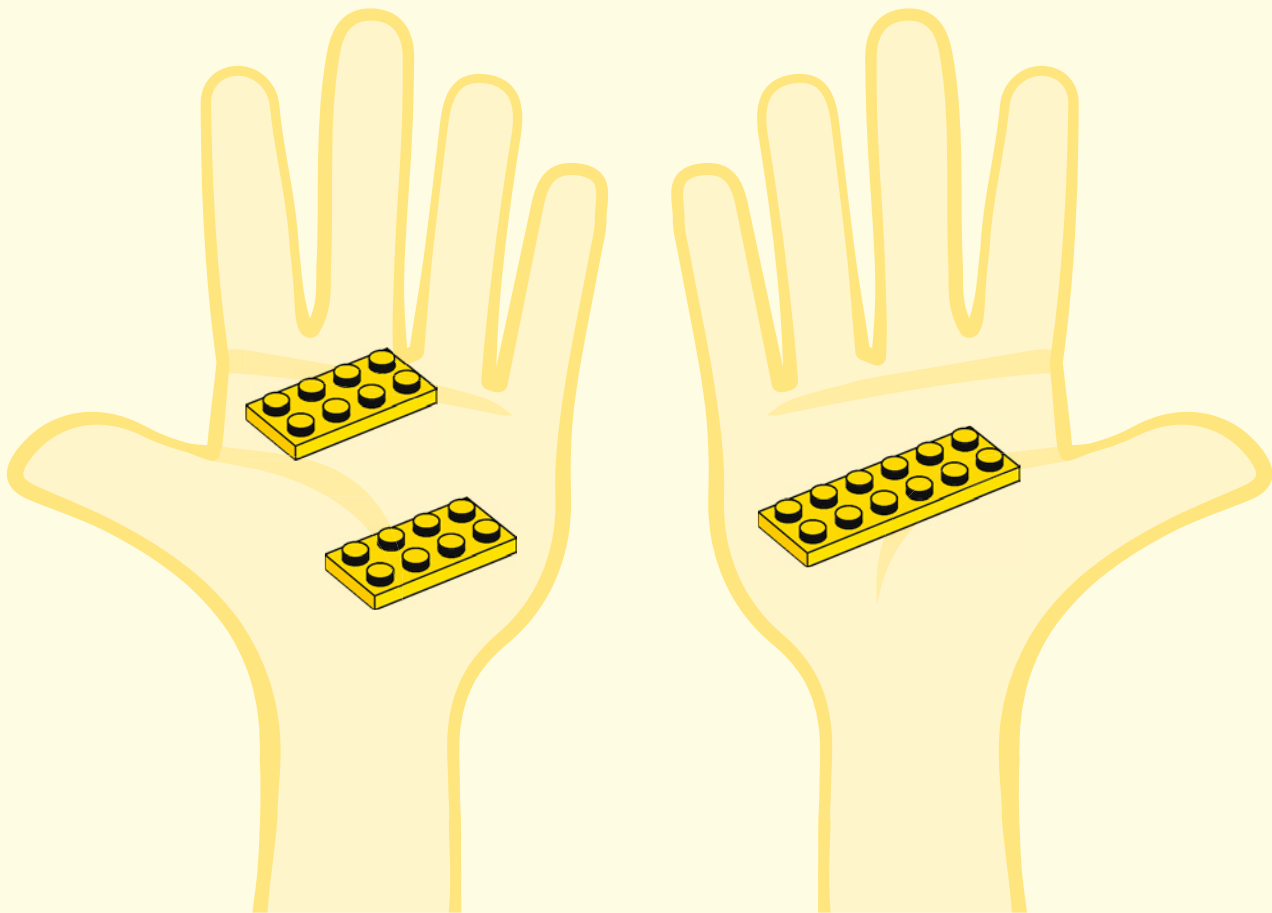



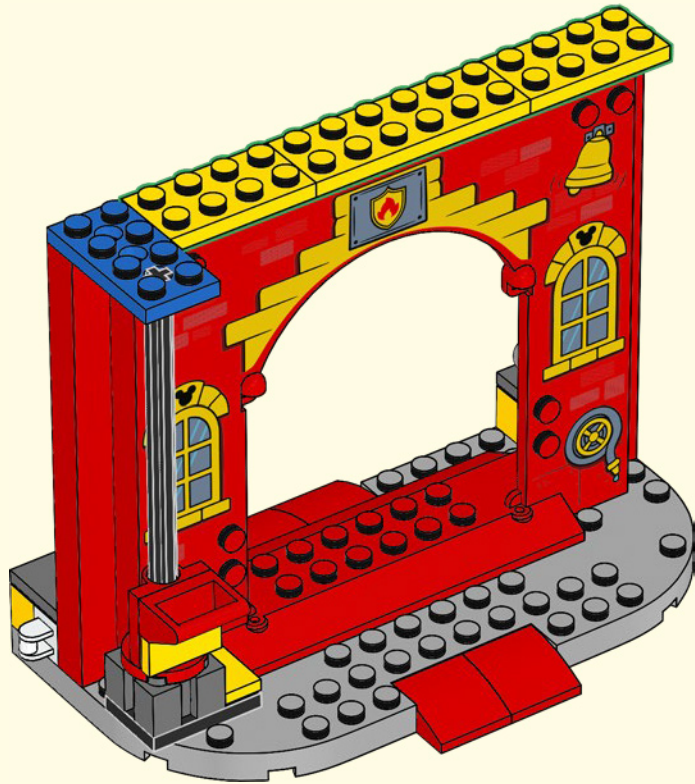

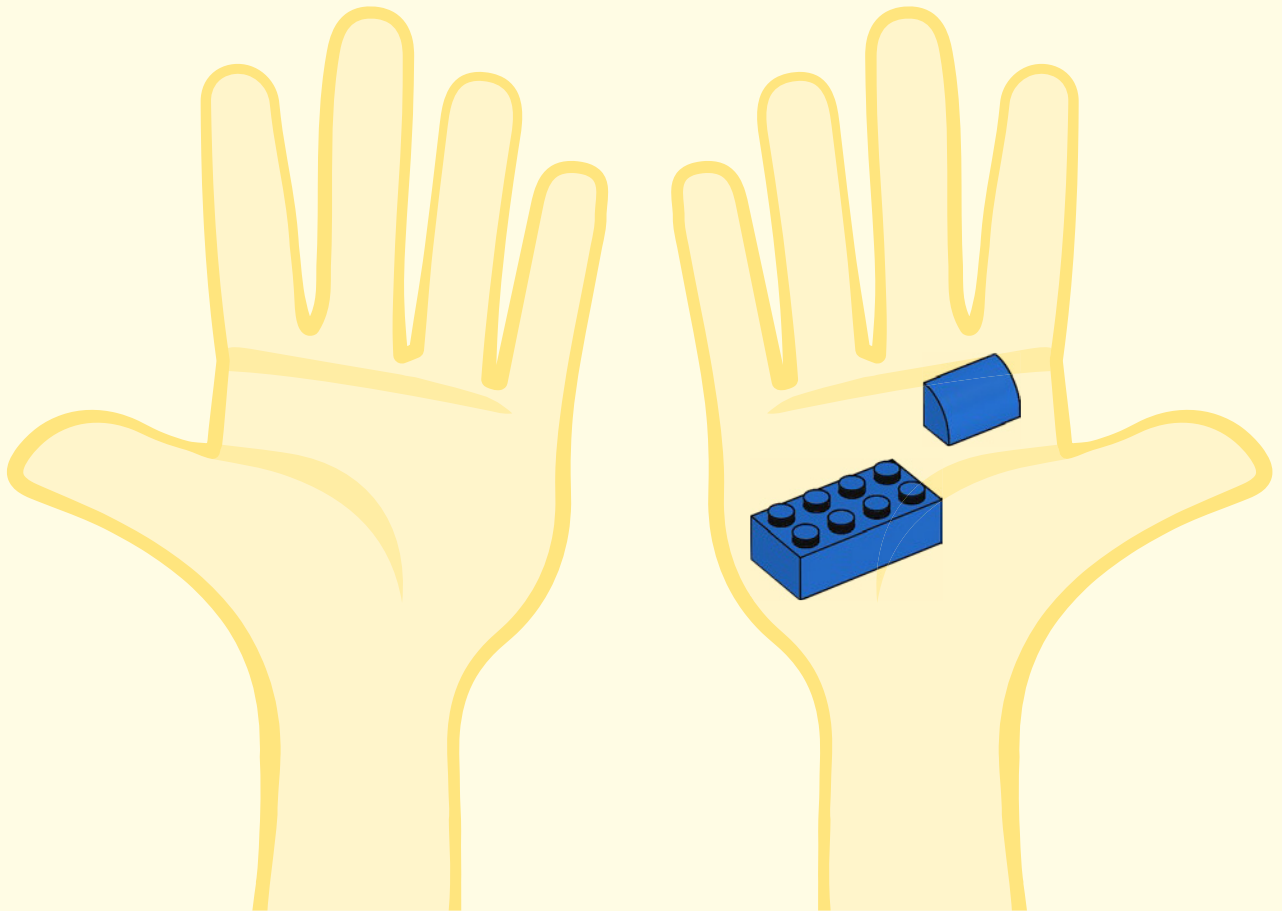

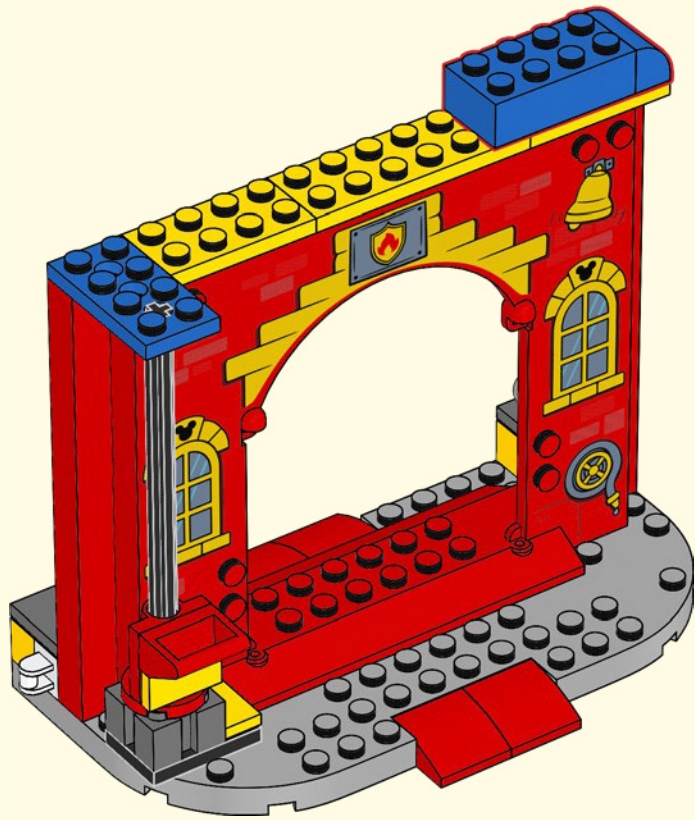

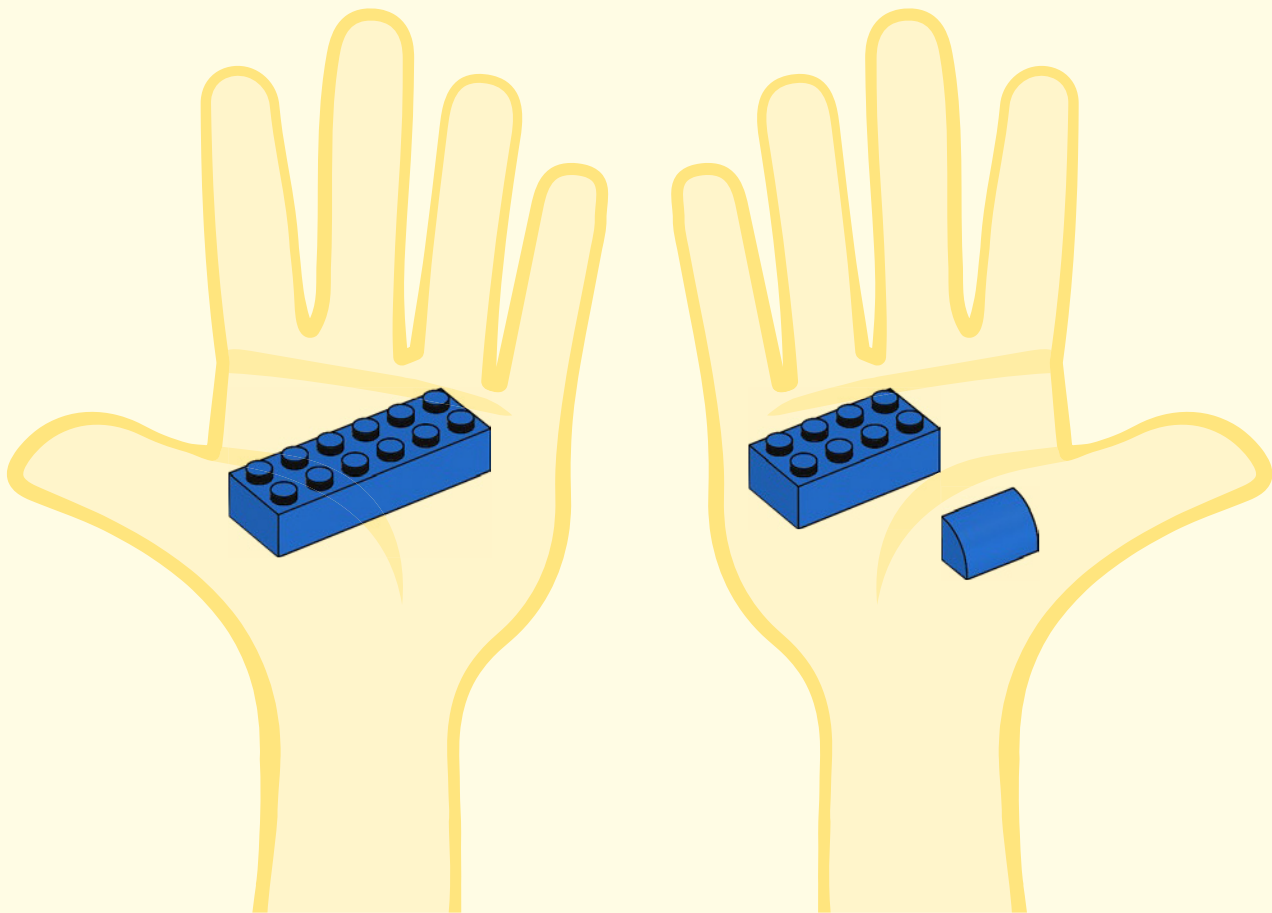

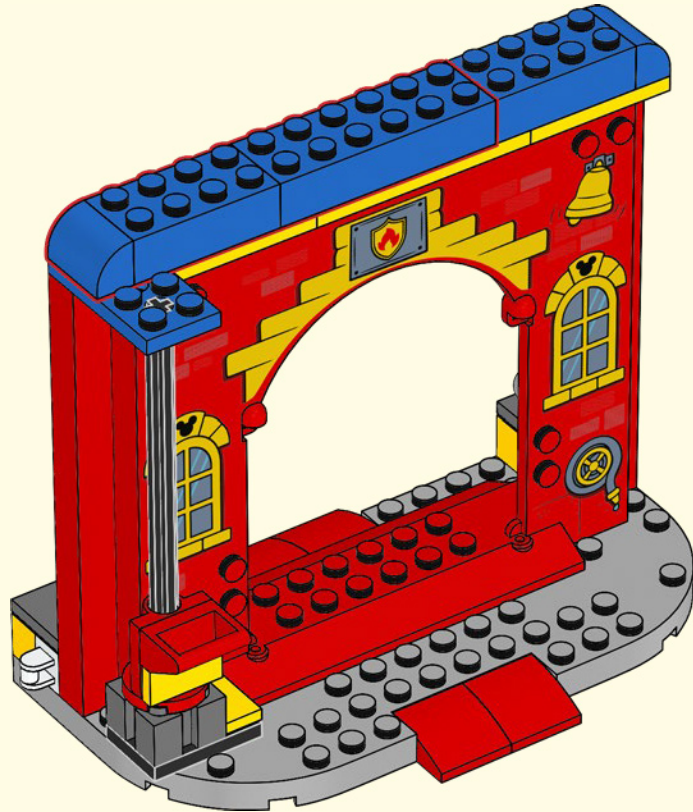

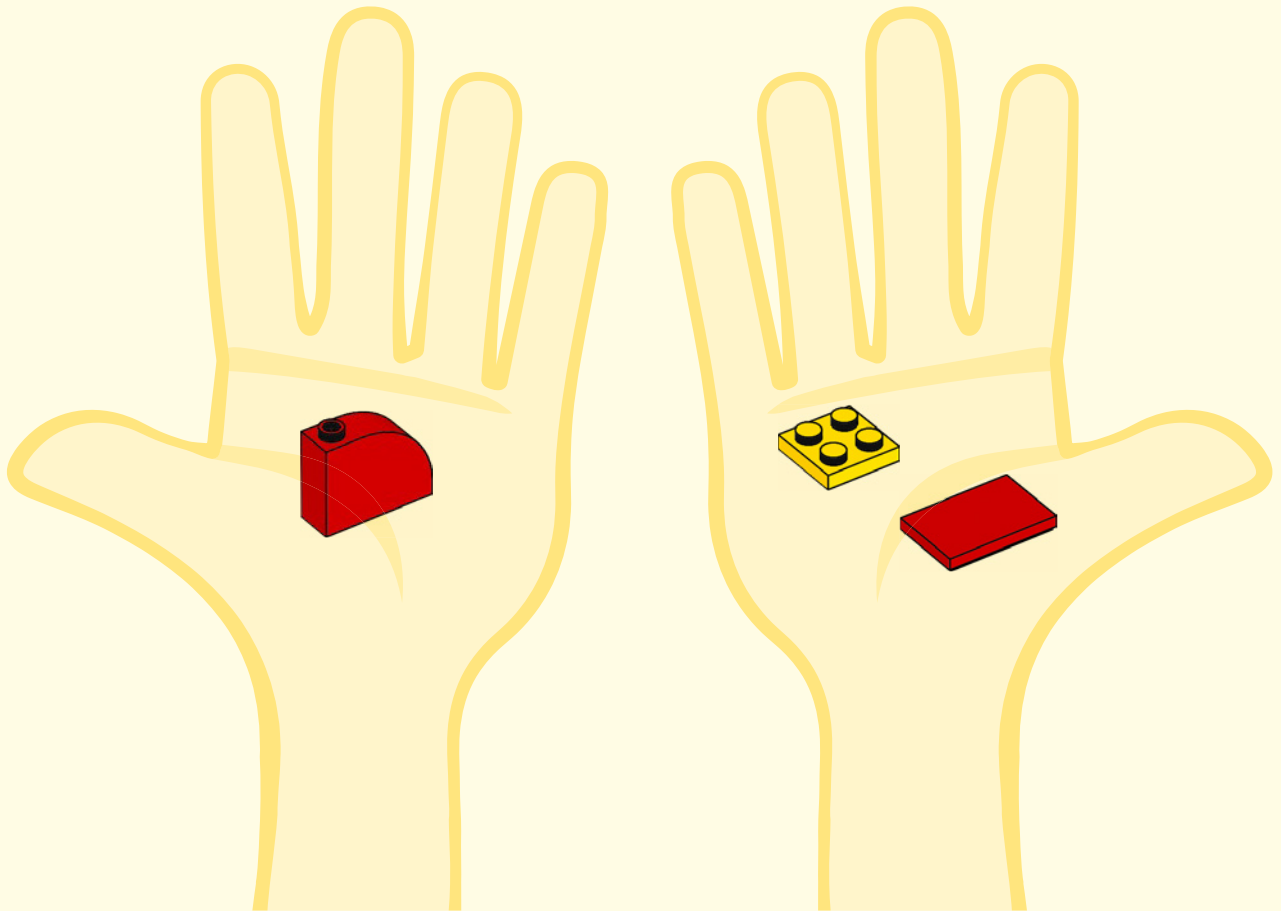

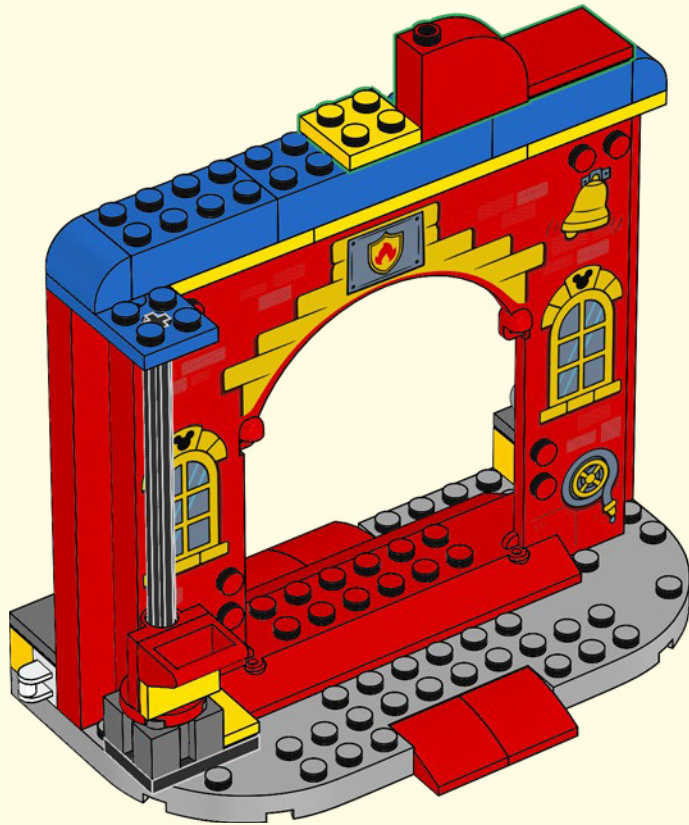

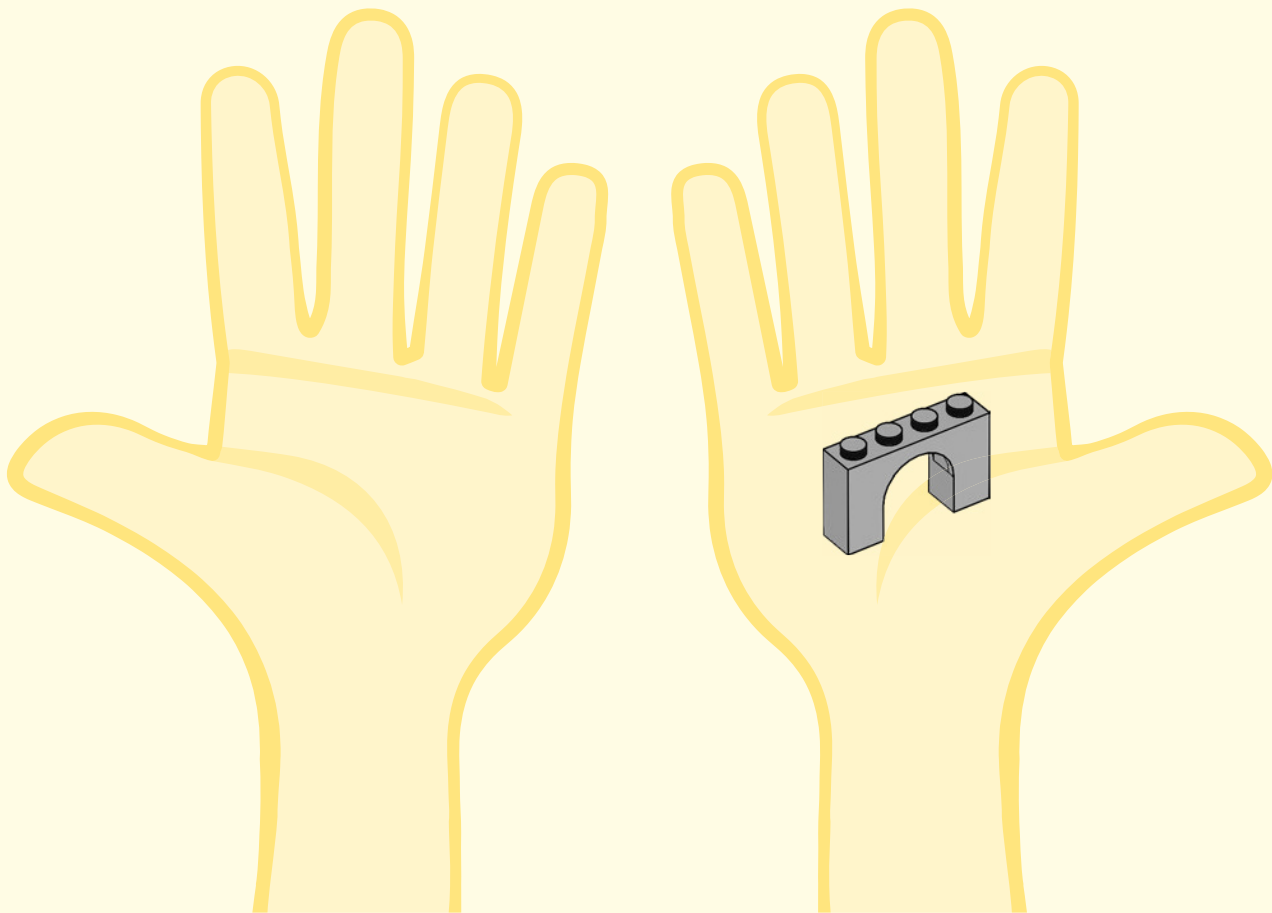



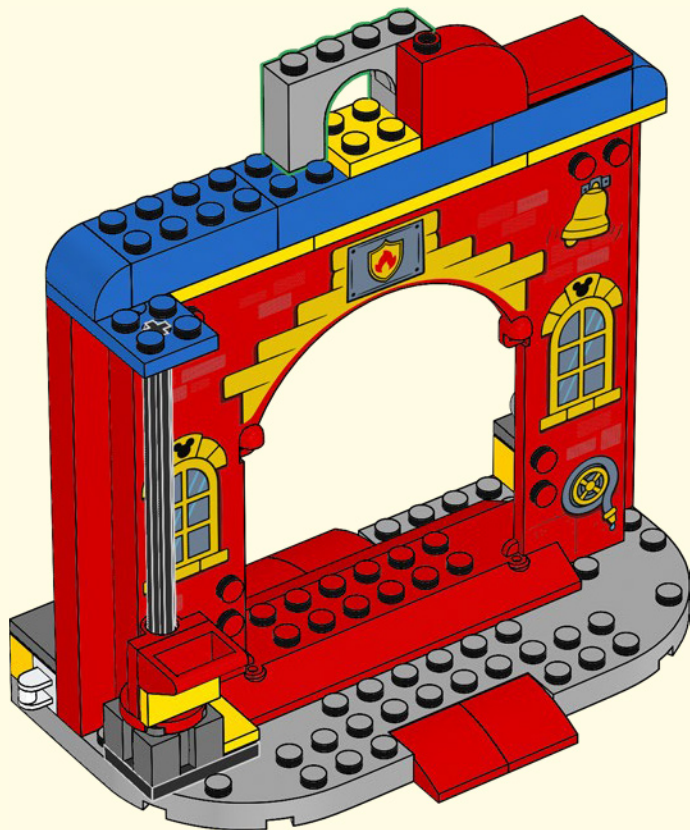

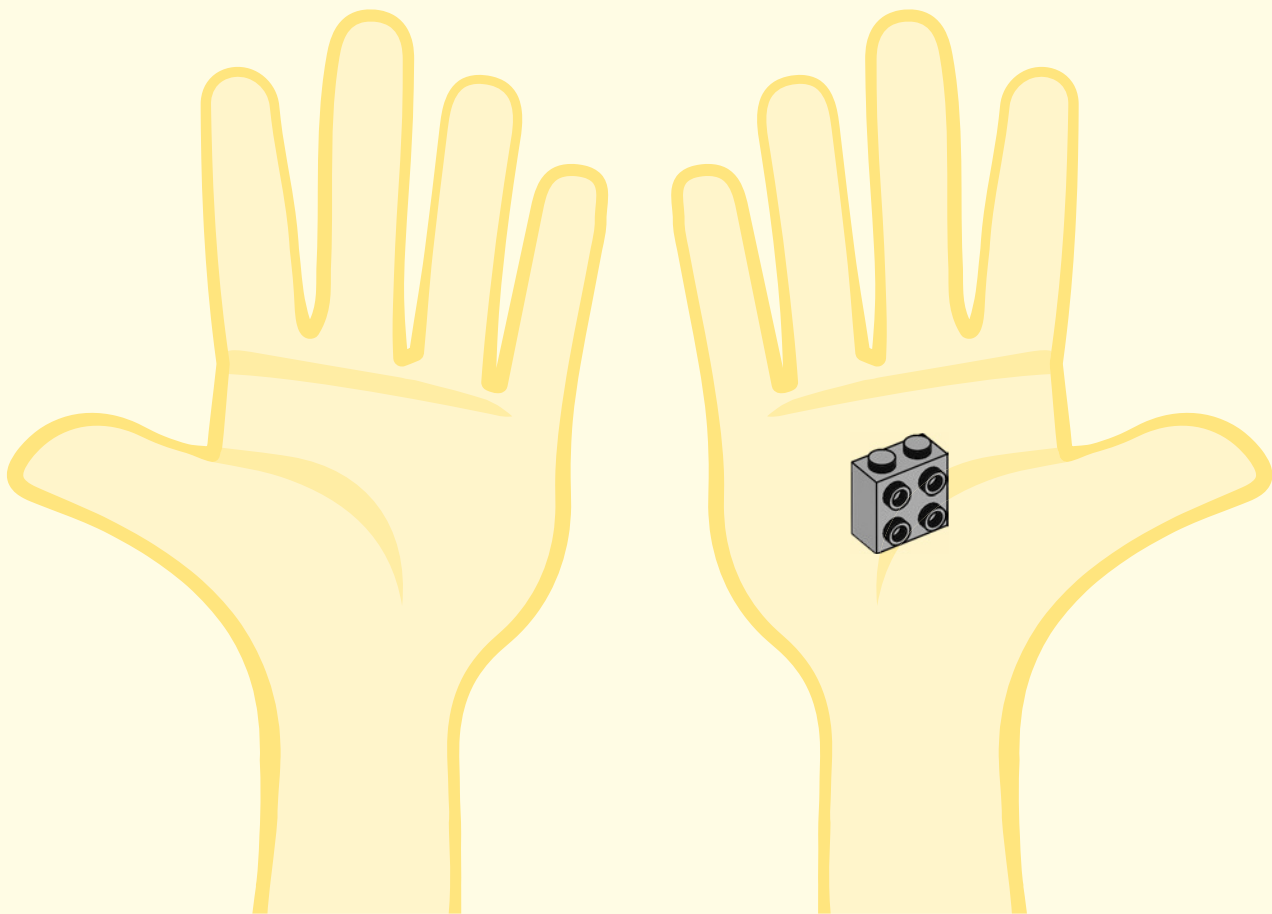

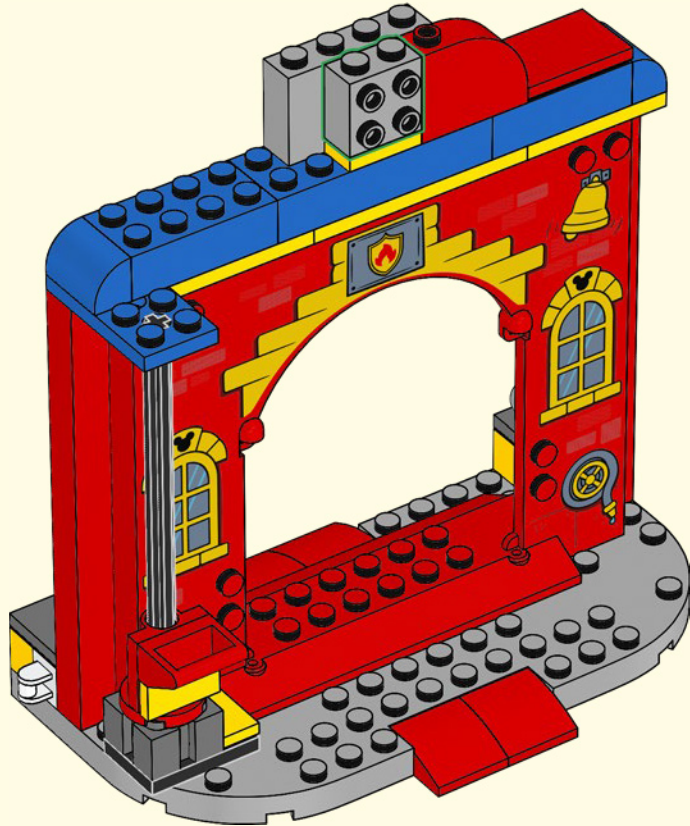

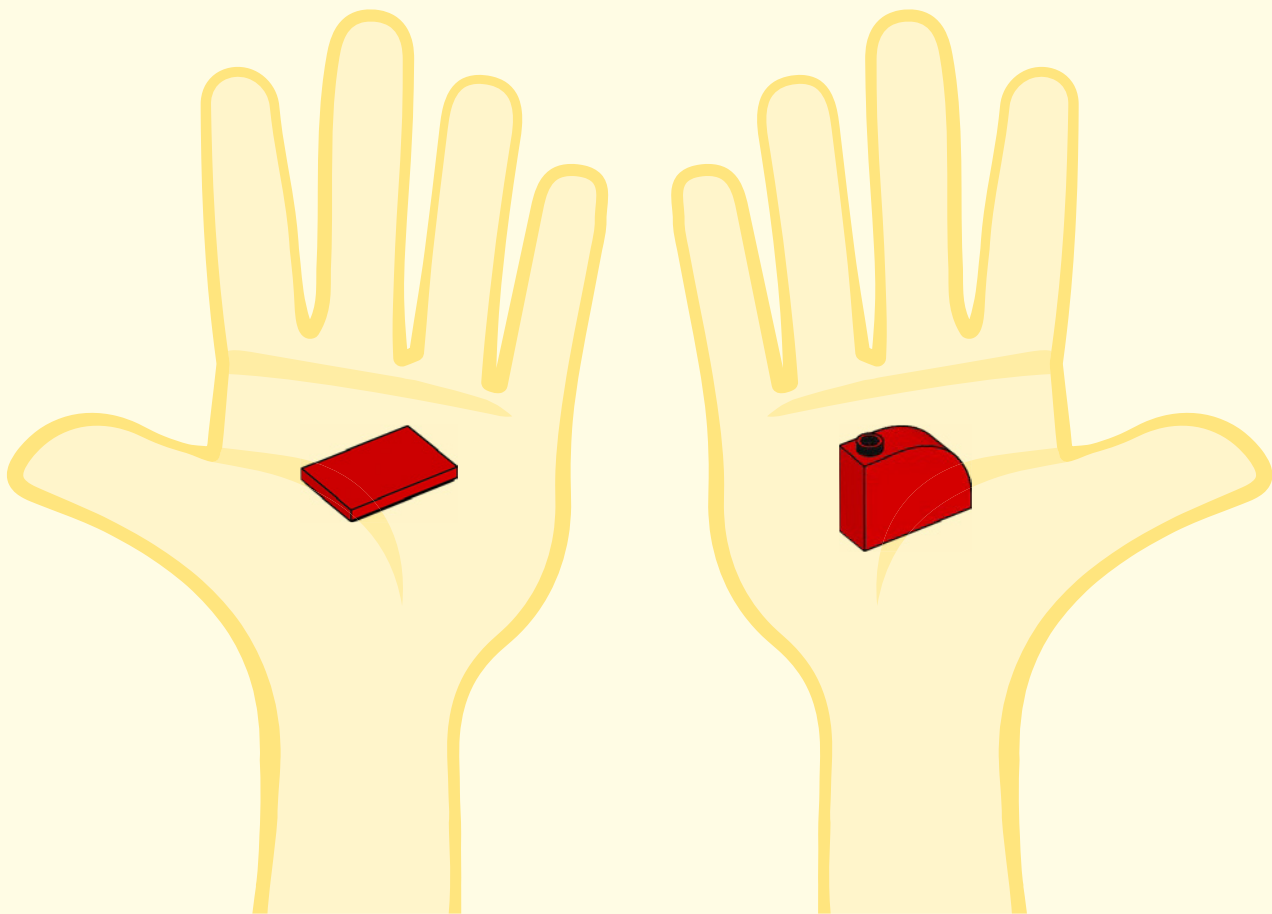

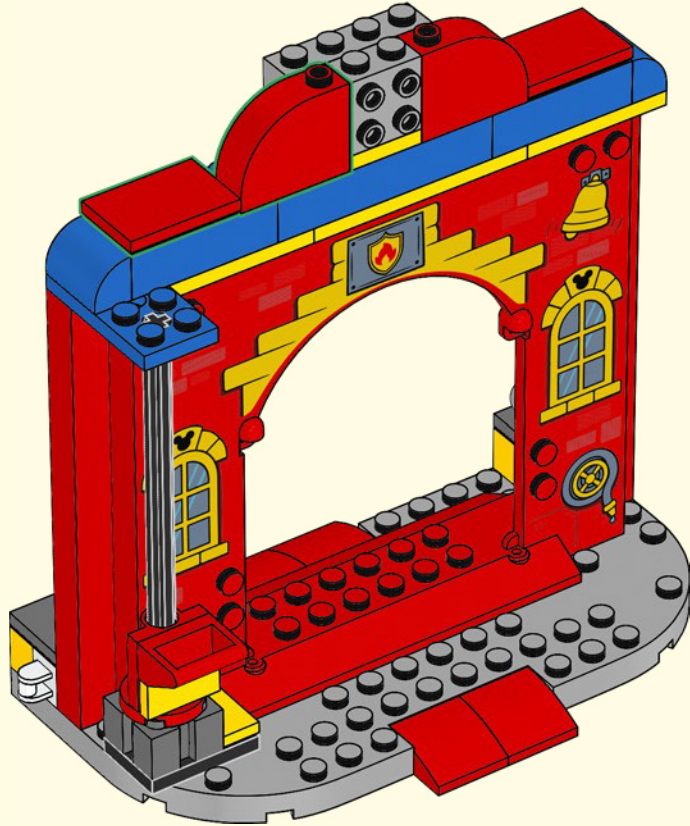

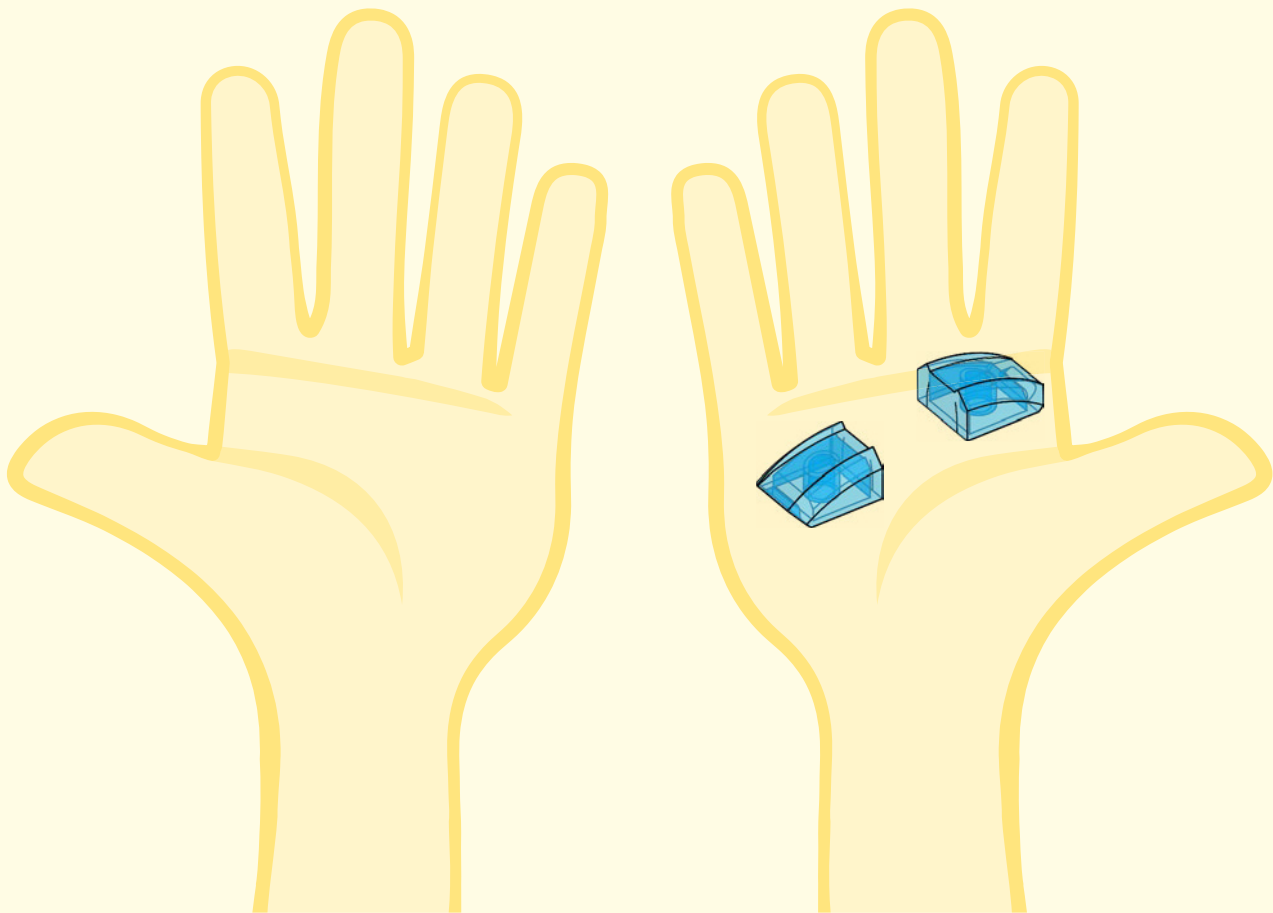

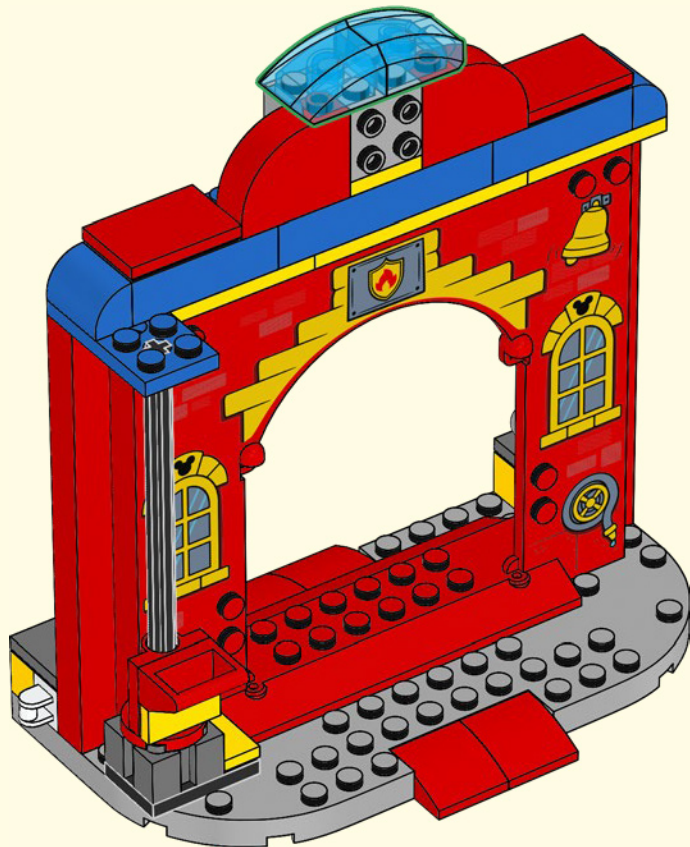

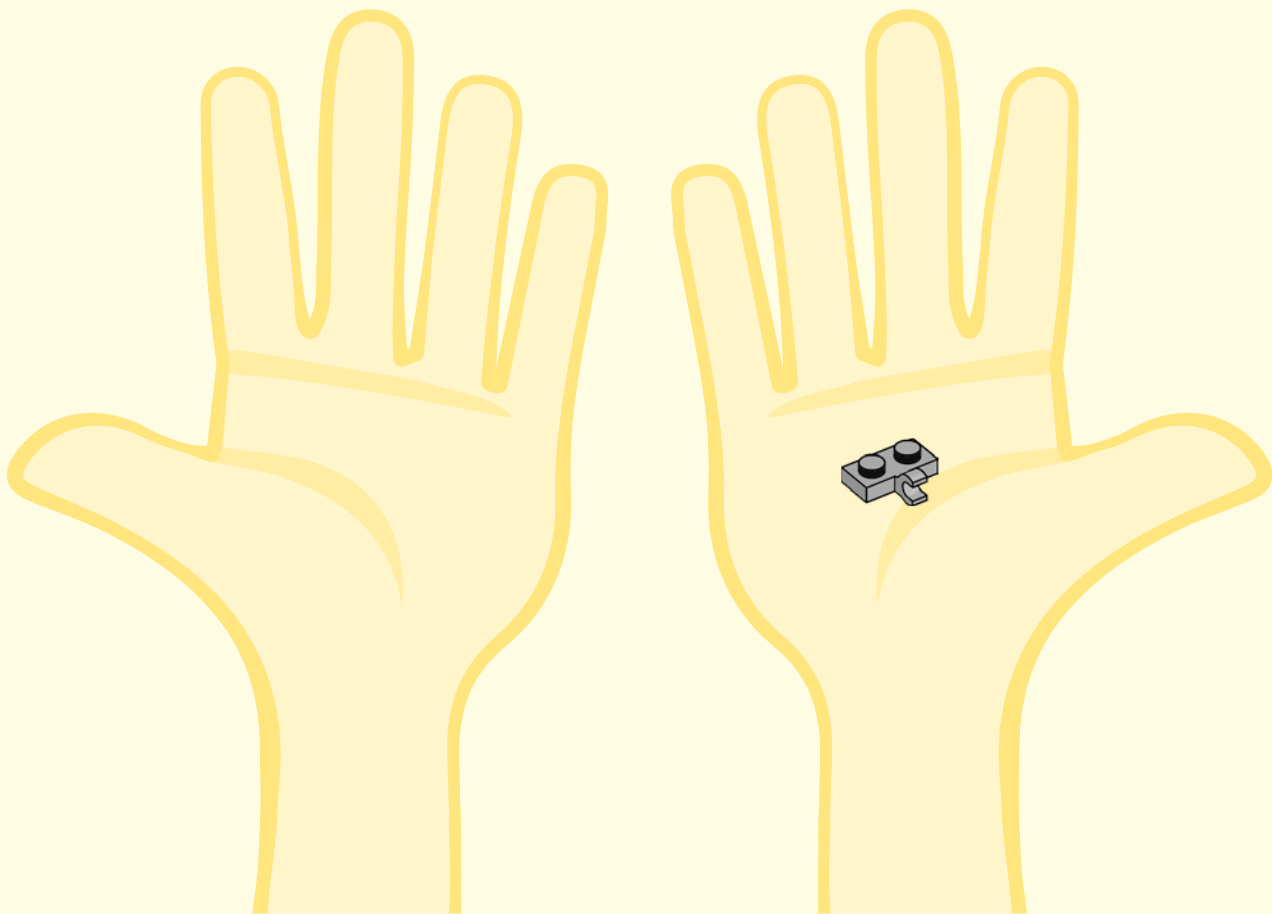



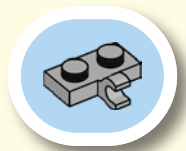
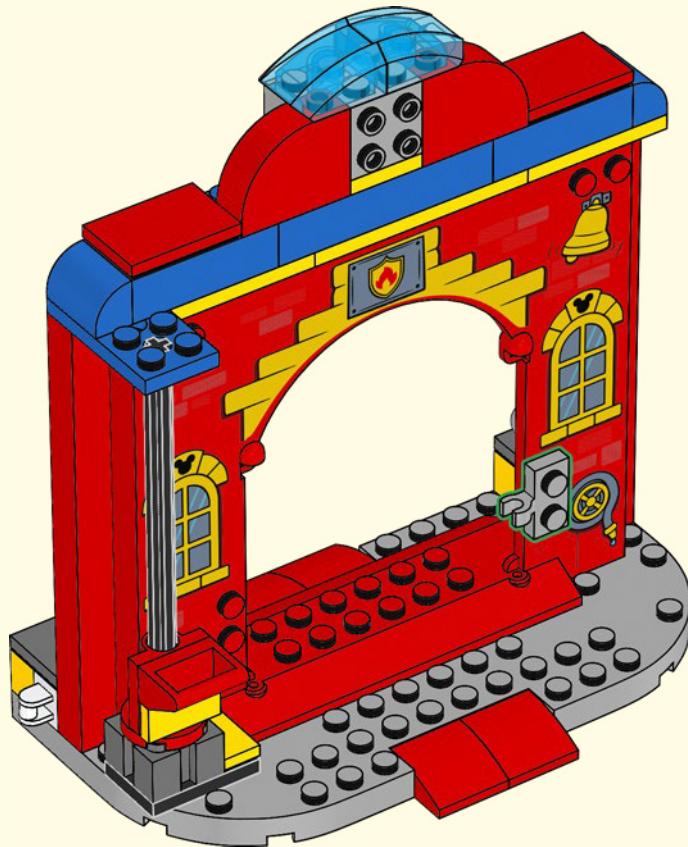

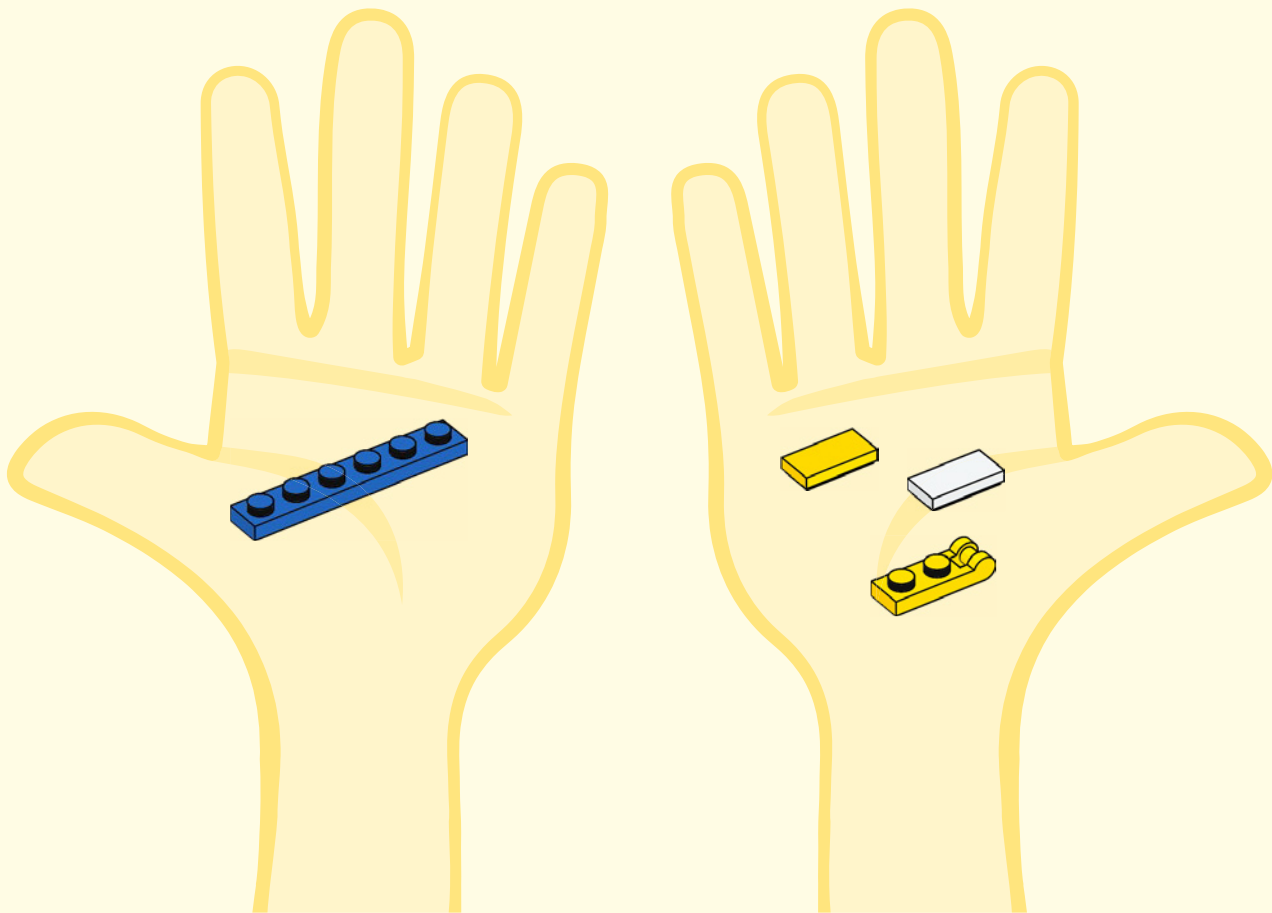

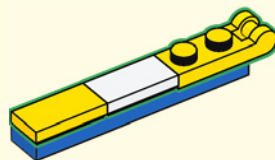
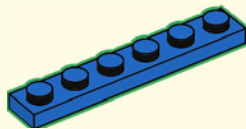

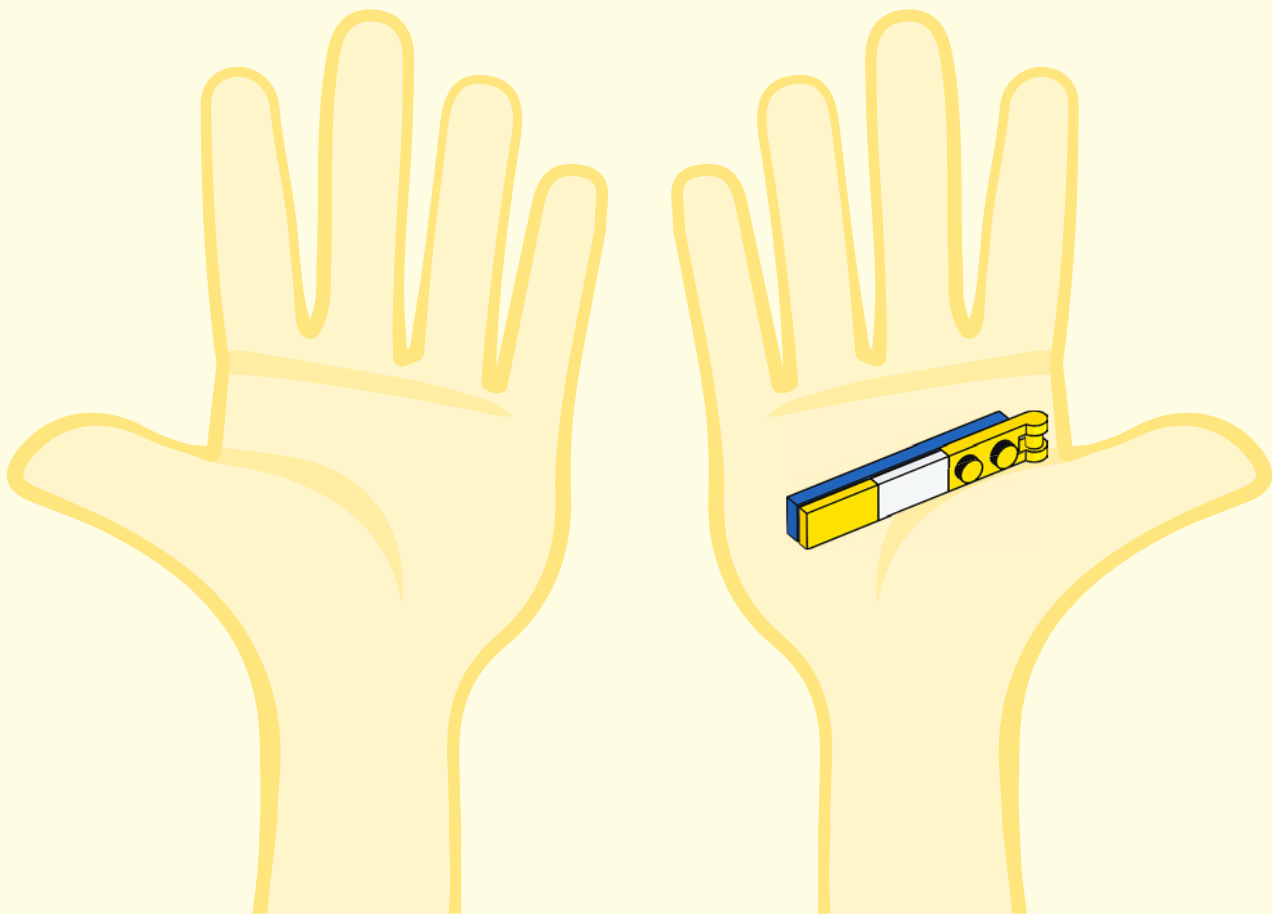

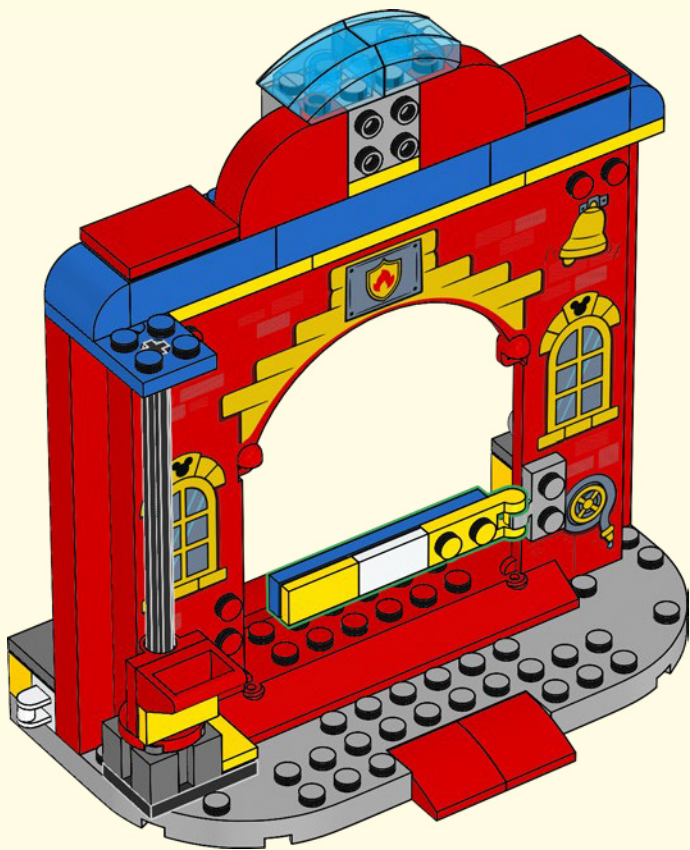

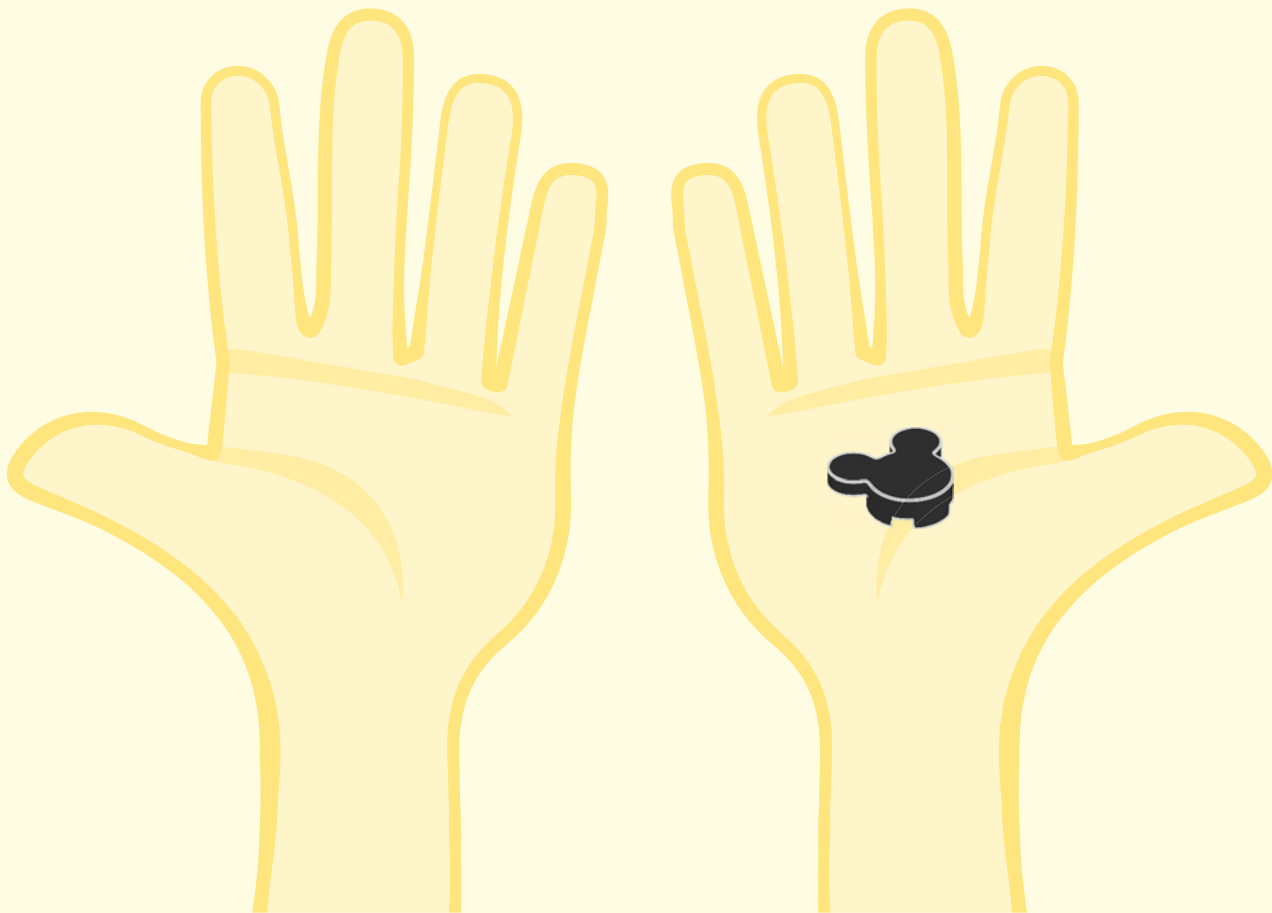

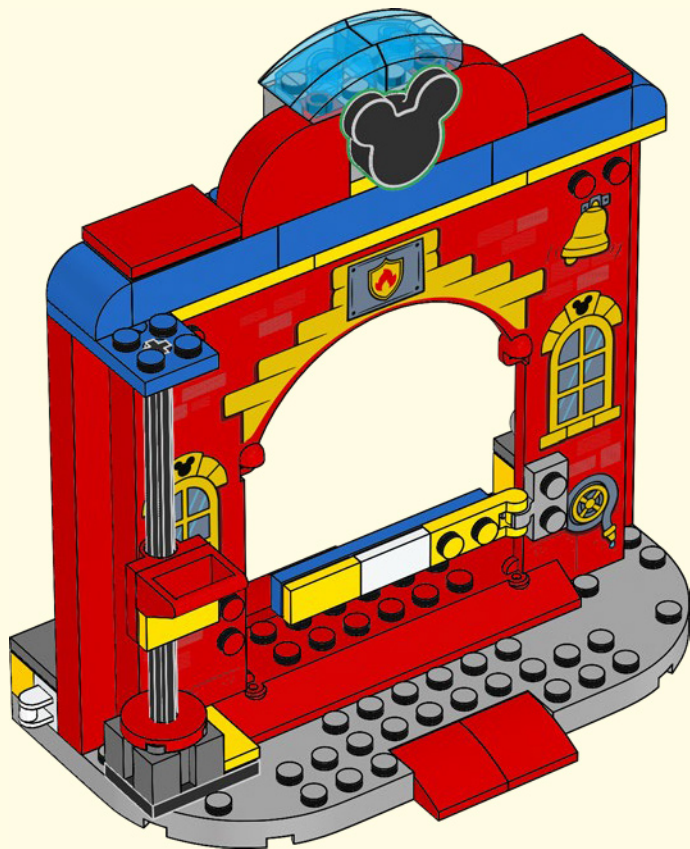

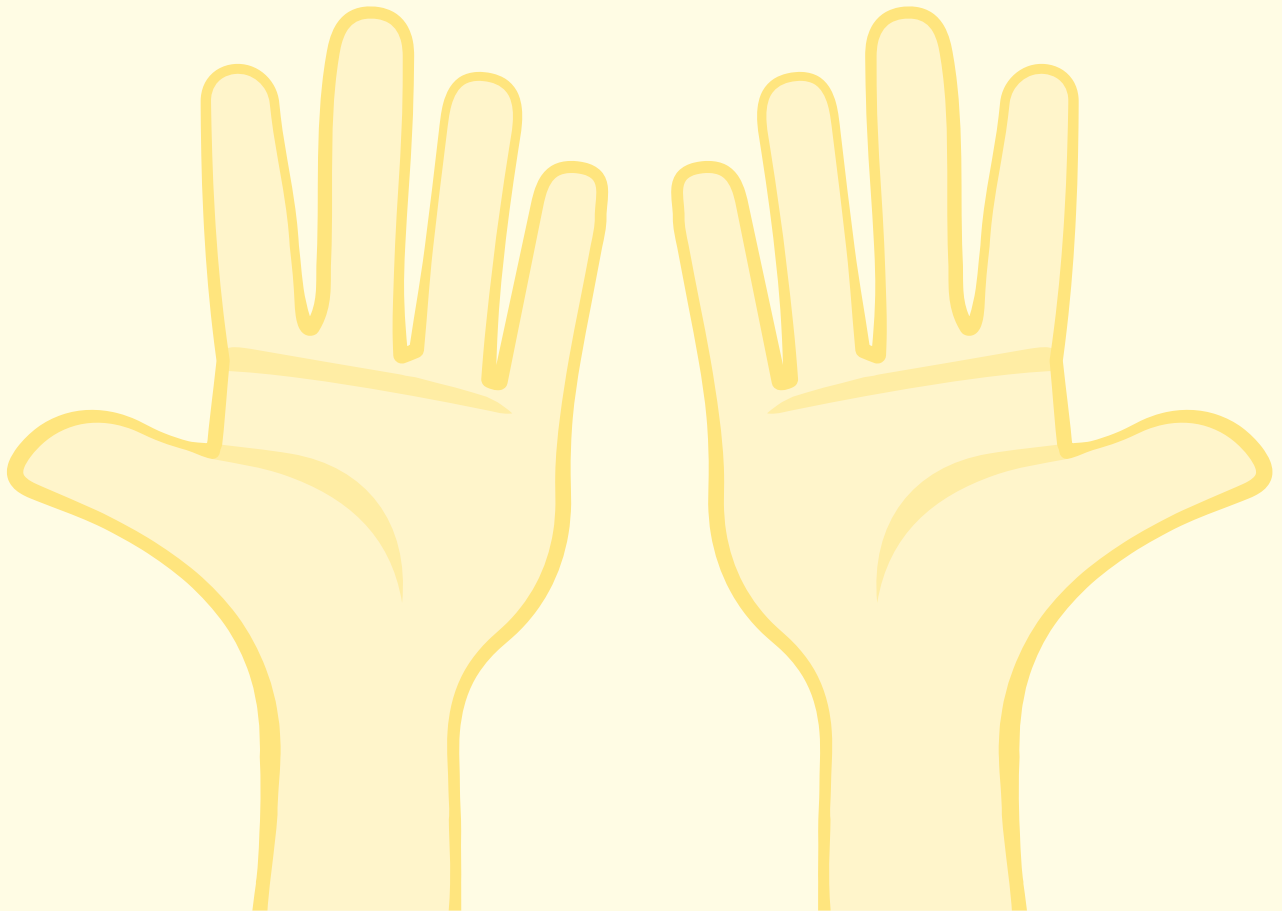



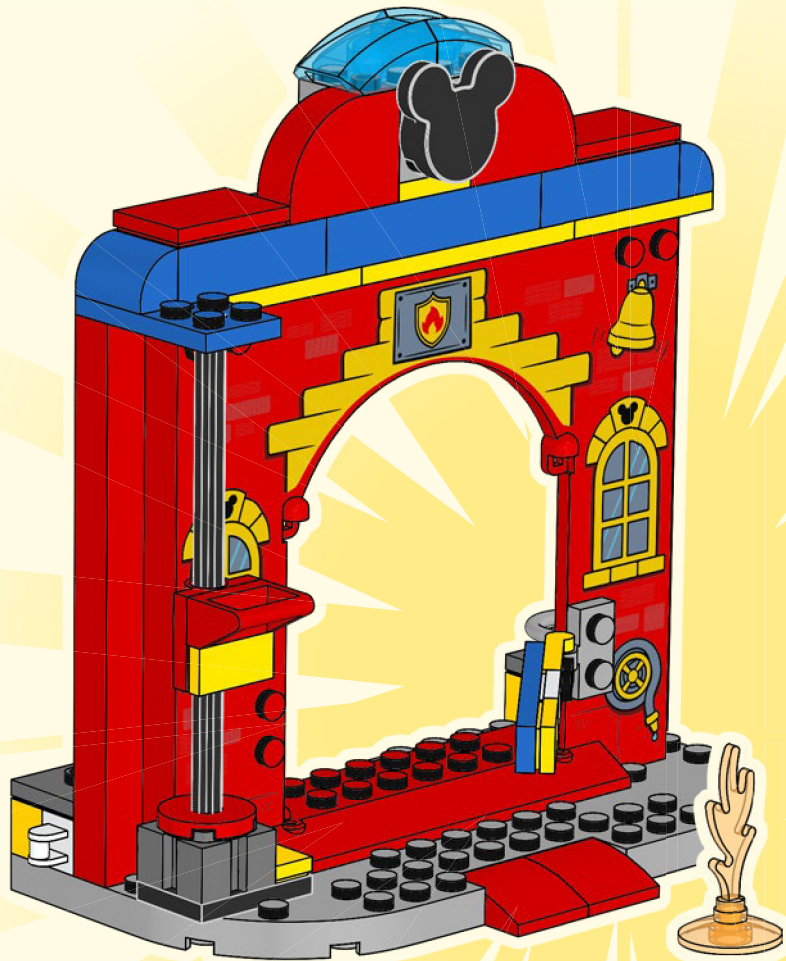



1x  
6170419



1x  
4600294



1x  
306901



2x  
6198933



2x  
407901



1x  
6349380



2x  
6349371



2x  
6074910



1x  
389921

58



1x  
6083618



2x  
6144805



2x  
4651524



1x  
6102138



2x  
6342615



1x  
243221



4x  
6105976



1x  
281721



4x  
6289870



2x  
6189130



3x  
365921



2x  
6046379



1x  
6342616



2x  
4633914



2x  
6342619



1x  
6342618



1x  
6182664



1x  
6133225



1x  
9341



2x  
6290532



2x  
6055065



1x  
9566



1x  
4140586



4x  
302223



1x  
370923



2x  
300123



3x  
366623



2x  
6346472

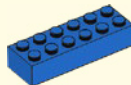

1x  
4181139



1x  
4256320



3x  
306924



6x  
300424



1x  
302224



1x  
4515367



1x  
6342626



2x  
302024



2x  
6257060



2x  
366624

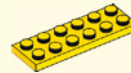

1x  
379524

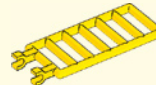

1x  
6070784

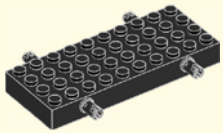

1x  
6352696



4x  
6336638



1x  
302126



1x  
395726



1x  
6278152



2x  
6330197



1x  
434926



1x  
6266998



1x  
6336633



1x  
370826



1x  
6240532



1x  
6238677



1x  
6167739



1x  
6253230



2x  
6301313



2x  
6251289



2x  
6171721



2x  
6167741



1x  
6245310



1x  
6279767



1x  
6003002



1x  
4211512



1x  
6092956



3x  
6066097



1x  
6313114



1x  
6123809



2x  
4244627



1x  
4223363



2x  
6168615



1x  
6031056



2x  
4211474



1x  
6352030



2x  
6352030



1x  
4211051



1x  
6152814



1x  
4210631



2x  
6126083



1x  
6071261



2x  
4211054



1x  
6352030



2x  
6352030



1x  
6352030



2x  
6352030



1x  
6352030



2x  
6352030



1x  
6236949



1x  
6346560



1x  
6342627



1x  
6342621

Customer Service  
Kundenservice  
Service Consommateurs  
Servicio Al Consumidor

LEGO.com/service or dial



: 00800 5346 5555

: 1-800-422-5346



# WIN

GO TO [WWW.LEGO.COM/PRODUCTFEEDBACK](http://WWW.LEGO.COM/PRODUCTFEEDBACK) AND  
GIVE US YOUR SHORT **FEEDBACK** ABOUT THIS  
LEGO® SET FOR A CHANCE TO WIN  
A COOL LEGO PRIZE.

Terms & Conditions apply



## [LEGO.com/productfeedback](http://LEGO.com/productfeedback)

### GEWINNE

Erzähle uns auf  
[www.LEGO.com/productfeedback](http://www.LEGO.com/productfeedback)

etwas über die Erfahrungen, die du mit  
diesem LEGO® Set gemacht hast, und  
sichere dir die Chance auf einen coolen  
LEGO Preis!

Es gelten die Teilnahmebedingungen

### GAGNE

Rends-toi sur  
[www.LEGO.com/productfeedback](http://www.LEGO.com/productfeedback)

et donne-nous quelques commentaires  
sur ce produit LEGO® pour avoir une  
chance de gagner un prix LEGO !

Voir Conditions Générales

### GANANA

Visita  
[www.LEGO.com/productfeedback](http://www.LEGO.com/productfeedback)

y envíanos tu opinión acerca de este set  
LEGO®. ¡Participarás en el sorteo de un  
premio LEGO!

Términos y Condiciones aplicables

### 获取奖品

登录  
[www.LEGO.com/productfeedback](http://www.LEGO.com/productfeedback)

给出关于此乐高®套装的简短反馈，  
就有机会获得炫酷乐高奖品

《条款及条件》适用

LEGO and the LEGO logo are trademarks of the LEGO Group. ©2021 The LEGO Group.



Disney

10776



2

Check for compatibility  
Kompatibilität prüfen  
Vérifier la compatibilité  
Controlla la compatibilità  
Comprueba tu compatibilidad  
Verificar a compatibilidade  
Ellenőrizd a kompatibilitást  
Pārbaudīt saderību  
检查兼容性

[LEGO.com/devicecheck](https://LEGO.com/devicecheck)



乐高®拼搭指引



LEGO® Building Instructions



Download on the  
App Store



GET IT ON  
Google Play



腾讯应用宝  
安卓应用商店



Apple and the Apple logo are trademarks of Apple Inc.  
Google Play and the Google Play logo are trademarks of Google LLC.  
Tencent and the Tencent logo are trademarks of Tencent Inc.







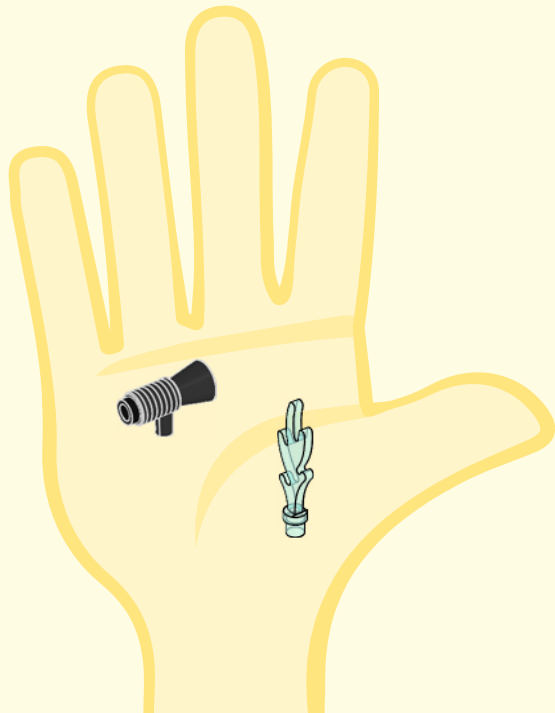

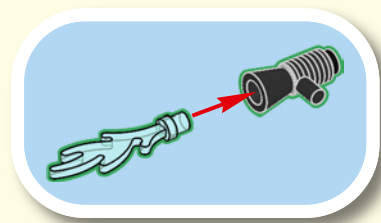
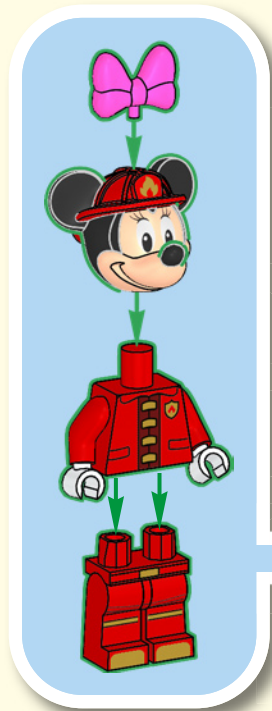

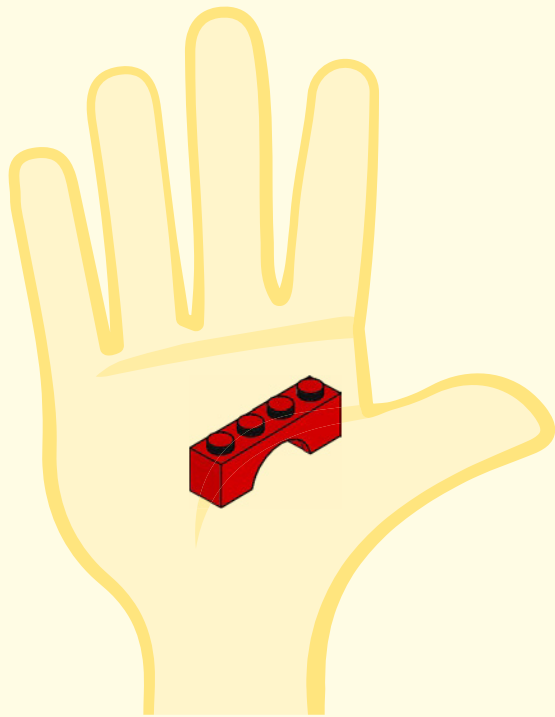
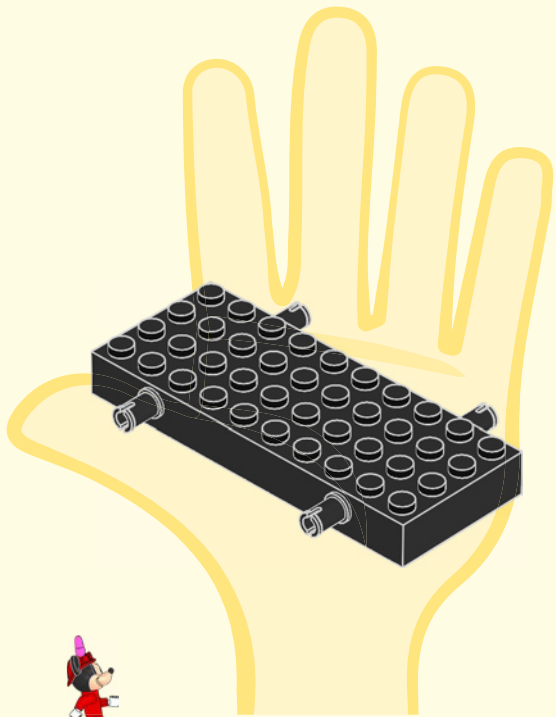

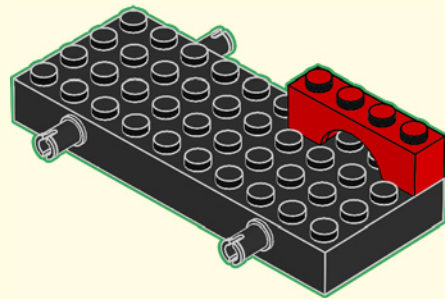

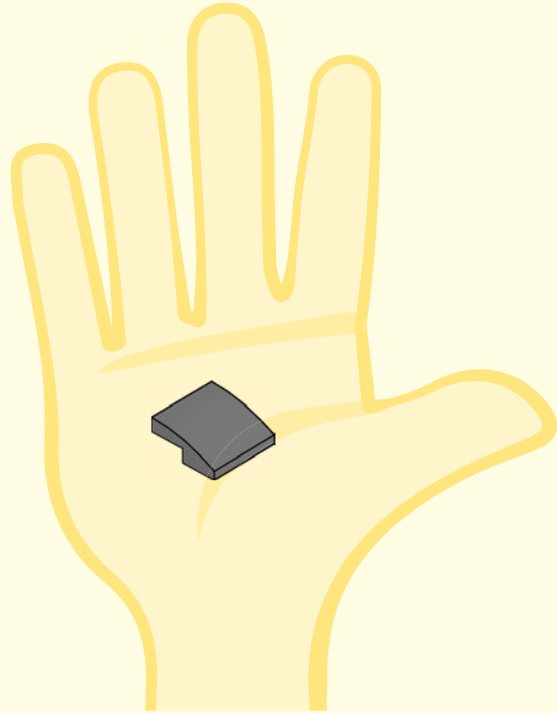
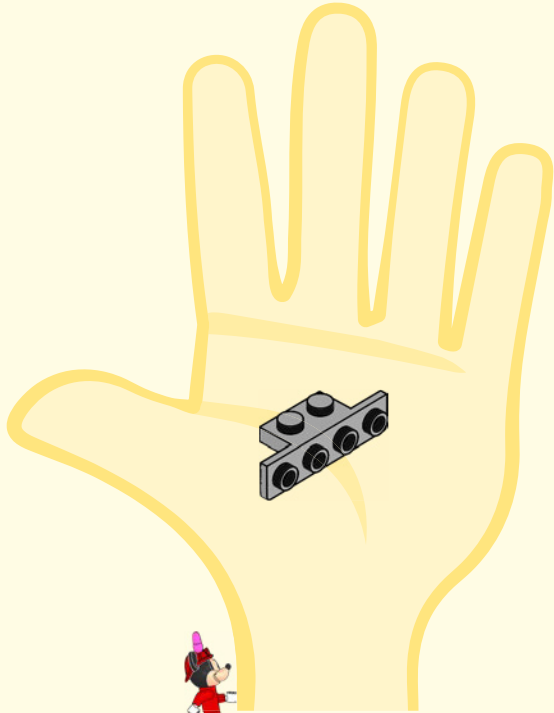

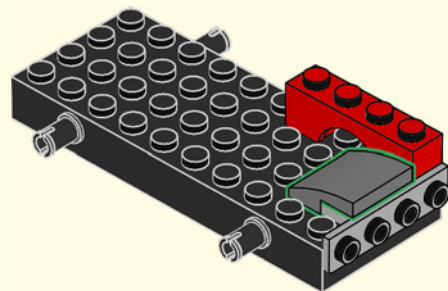
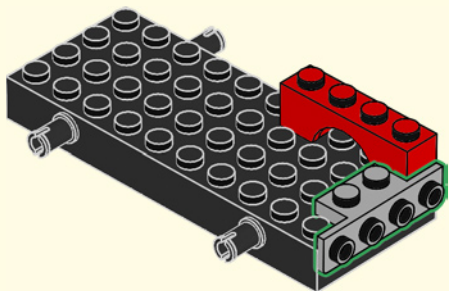

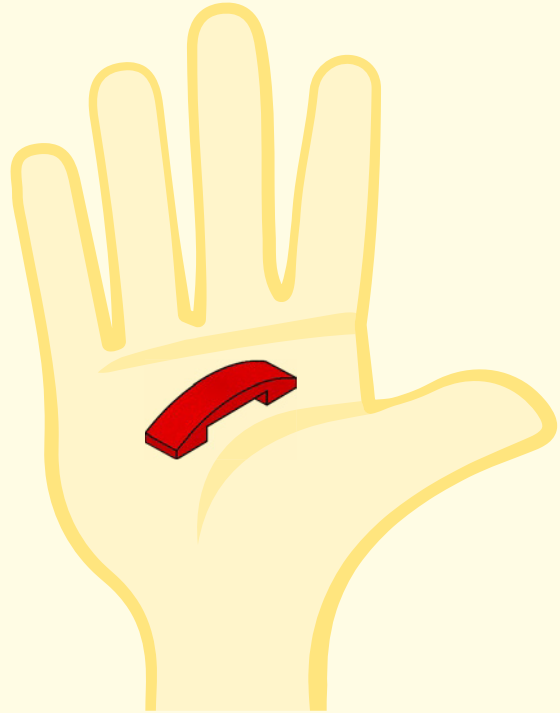
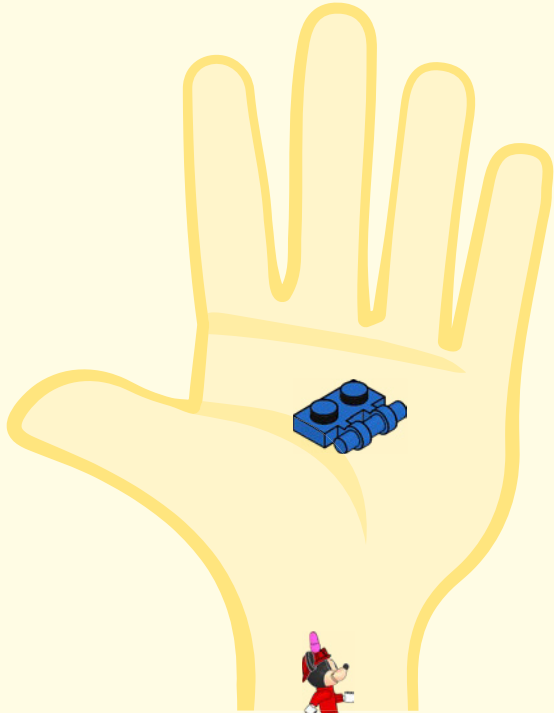



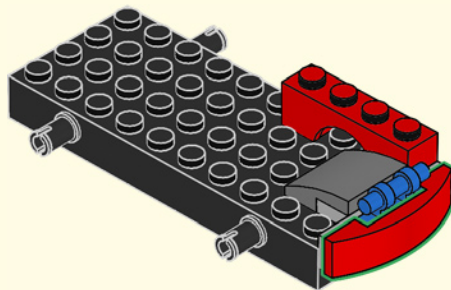
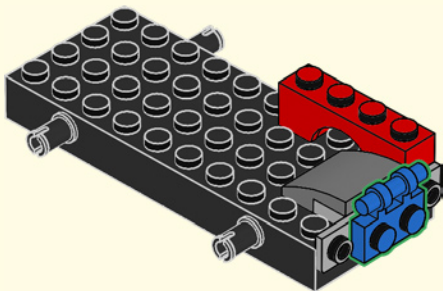

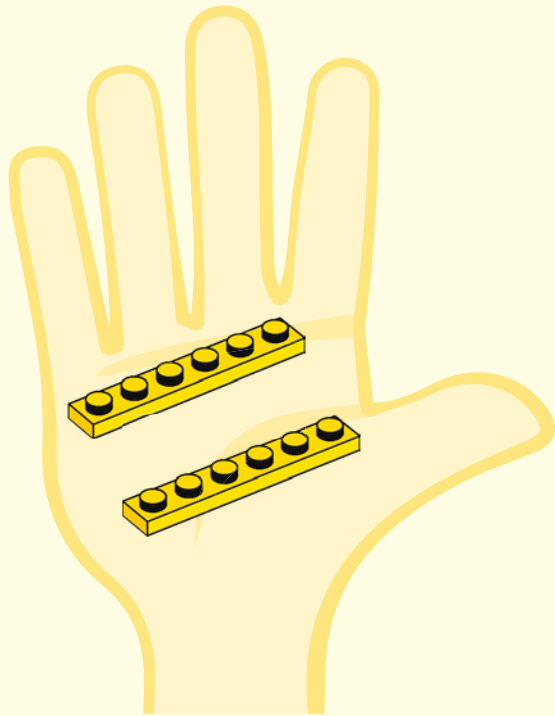
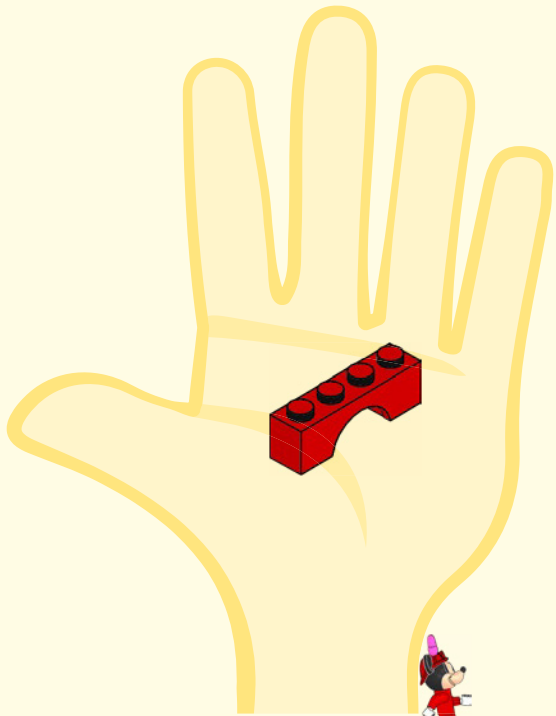

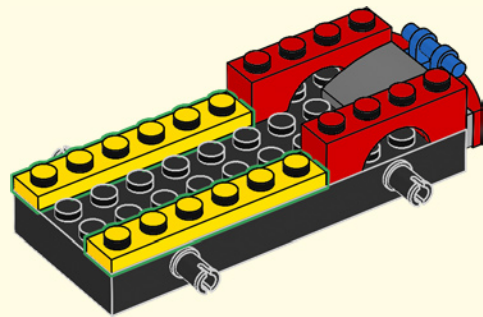
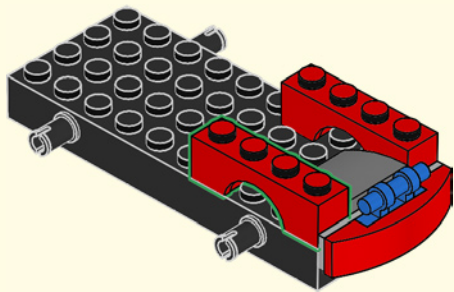

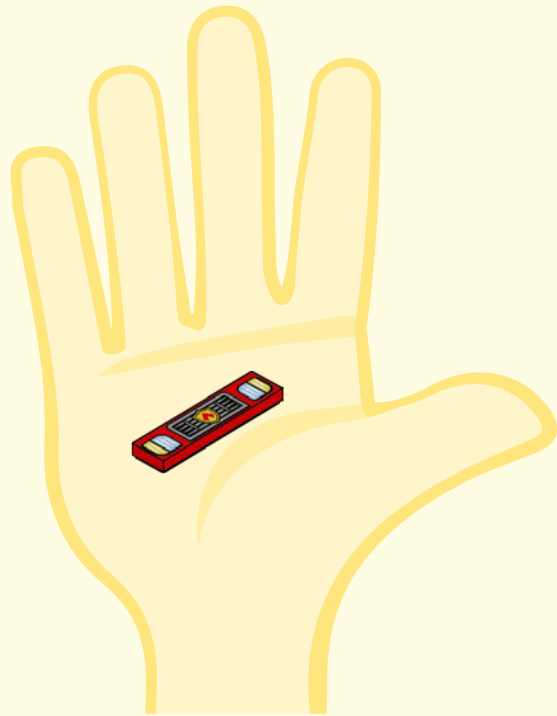
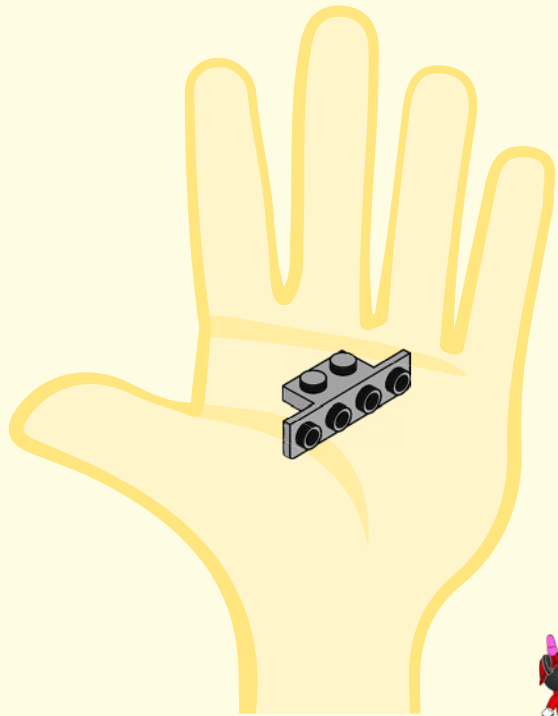

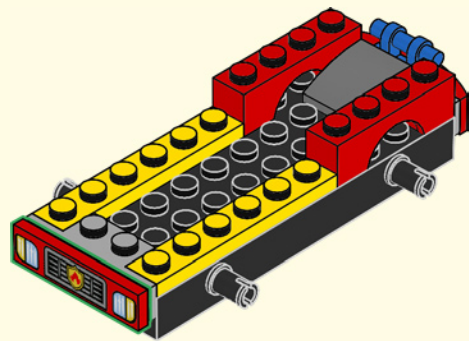
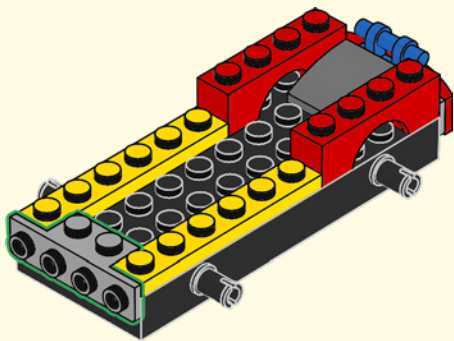

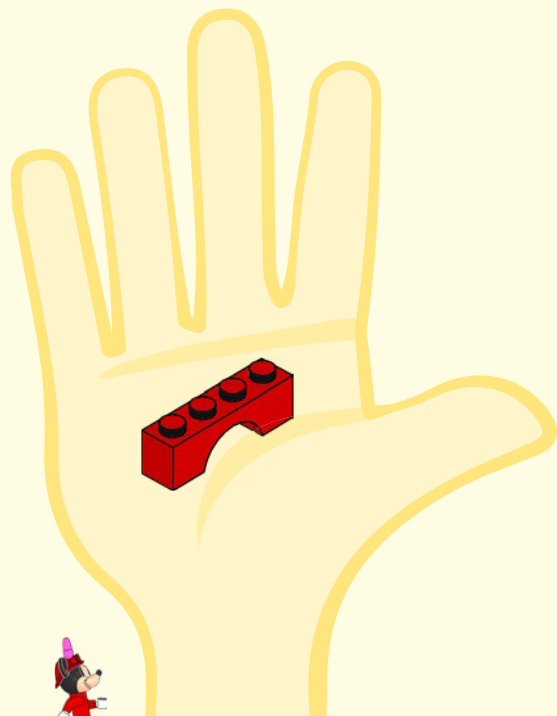
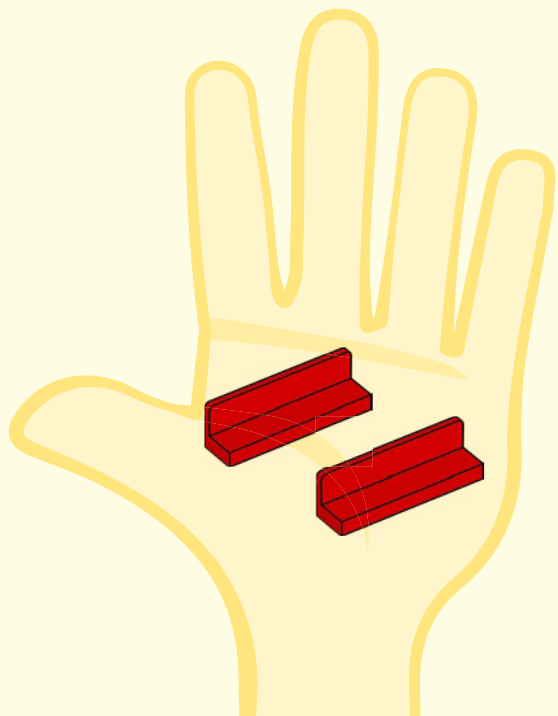

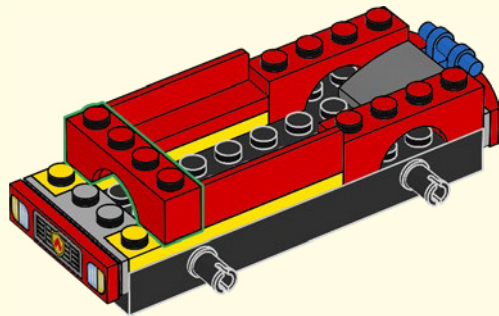
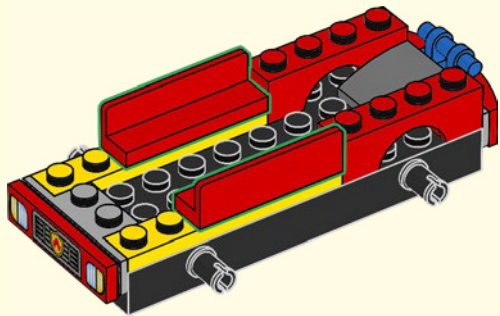

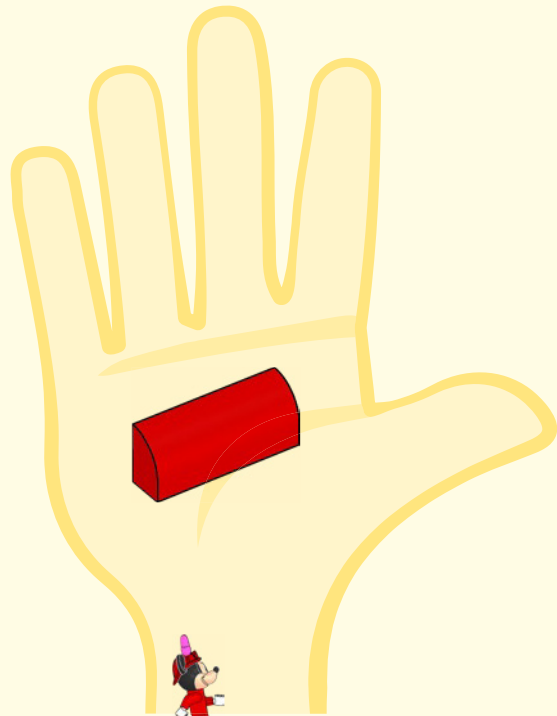
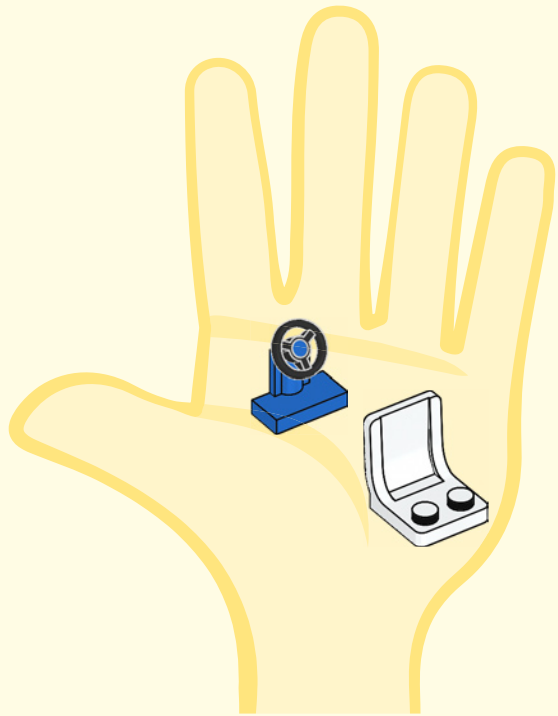



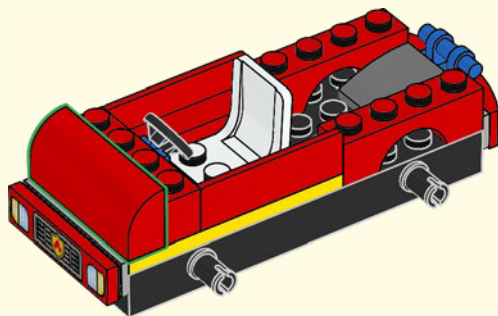
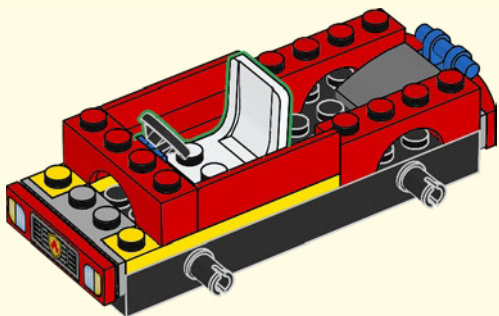
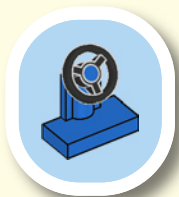

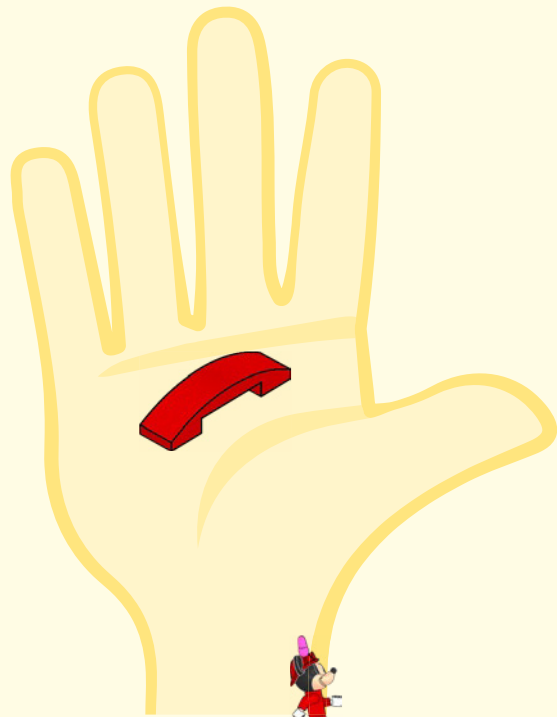
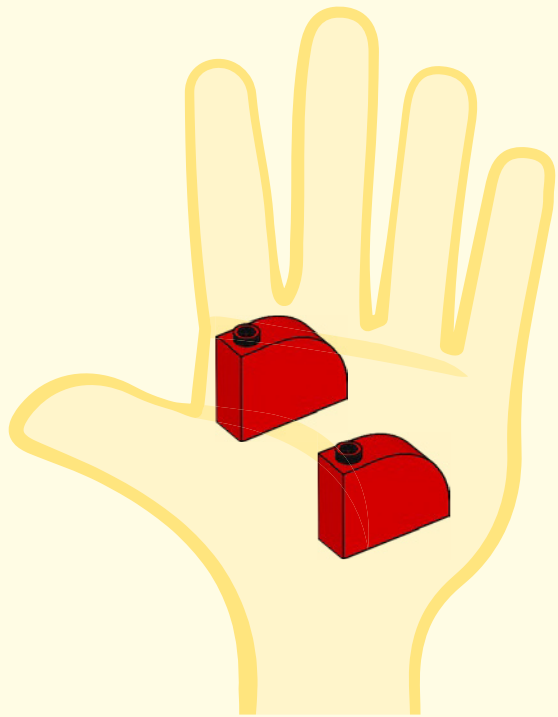

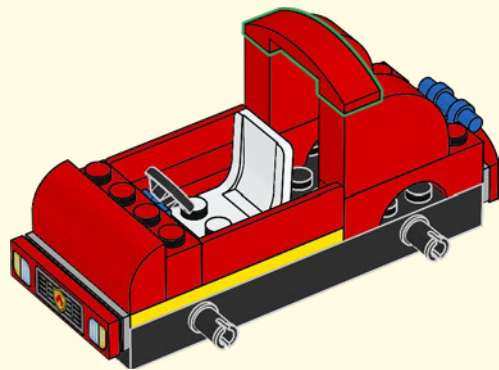
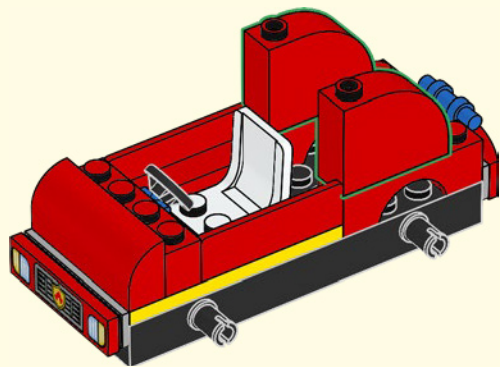

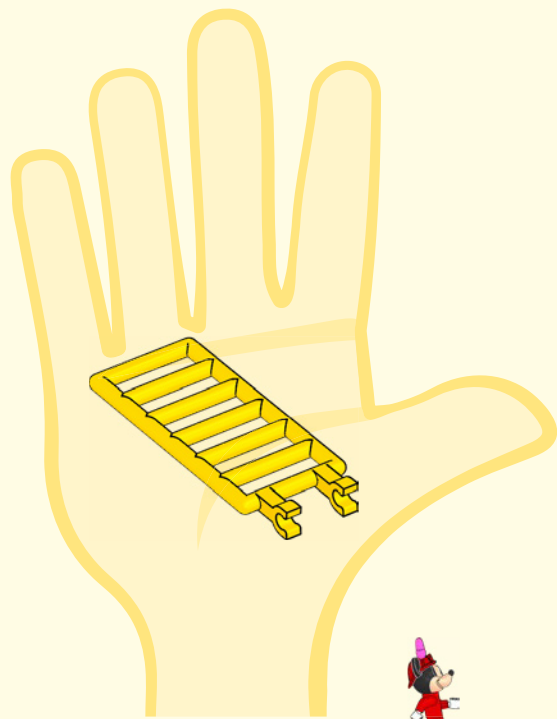

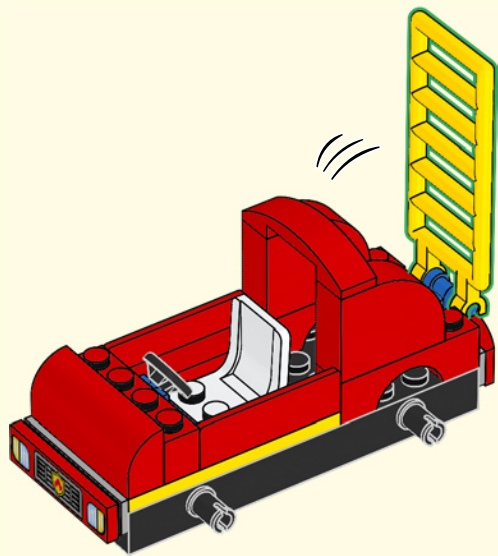

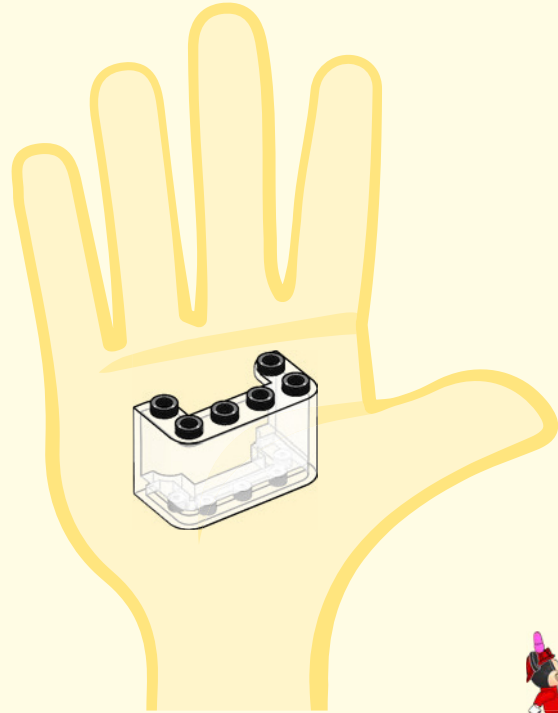

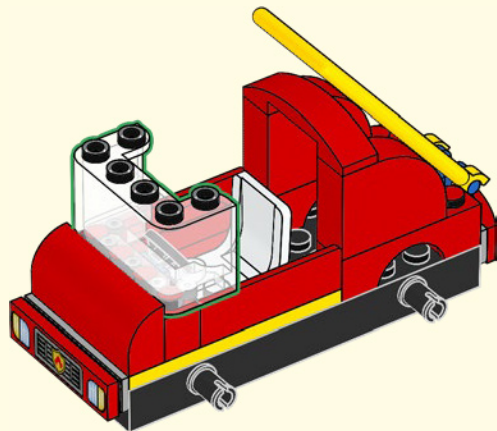

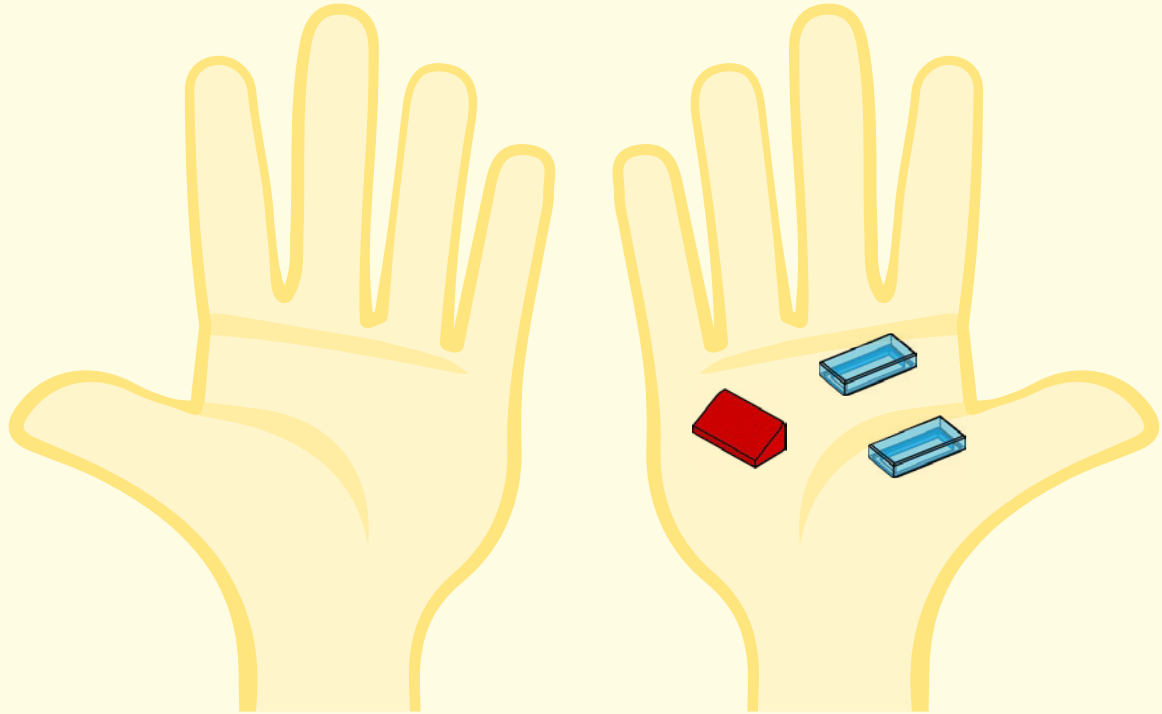



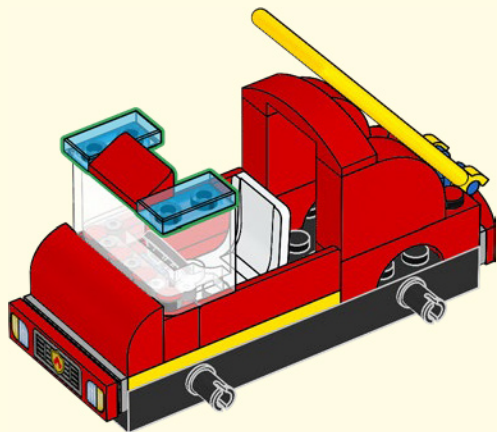

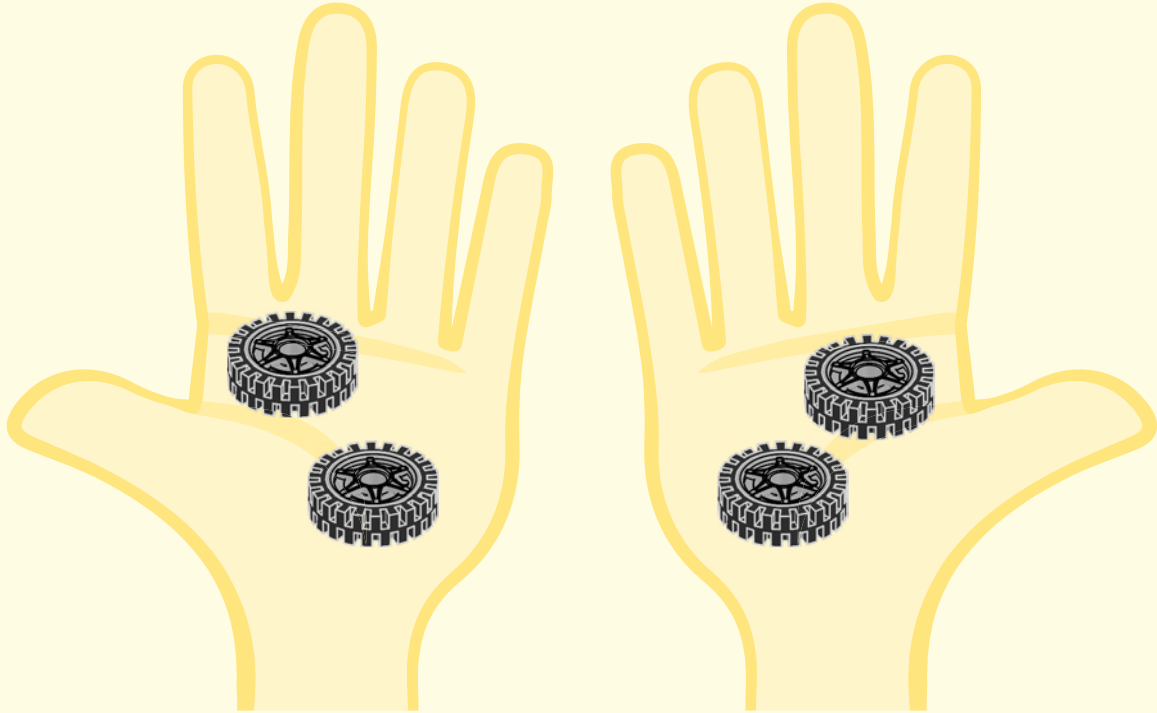

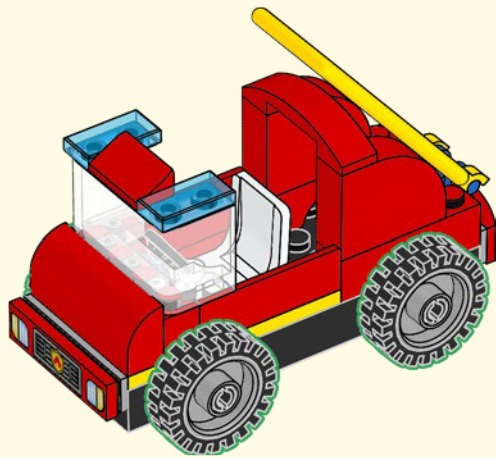

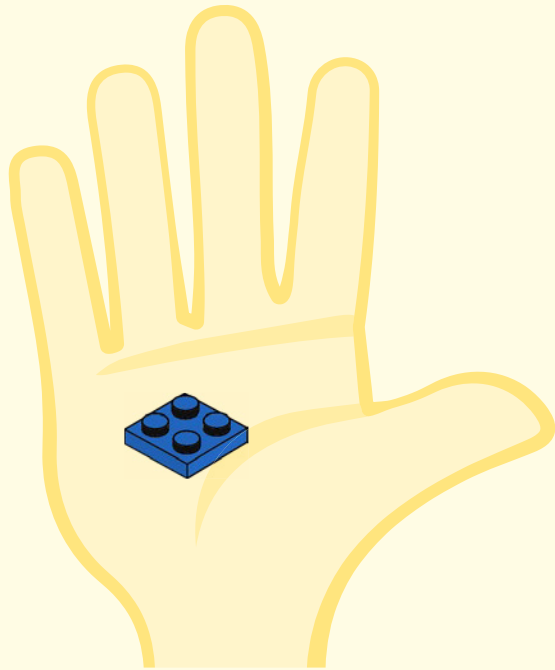

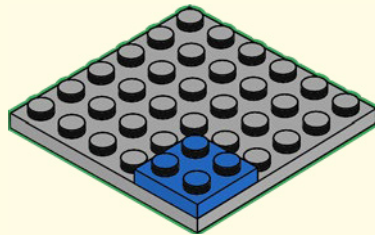

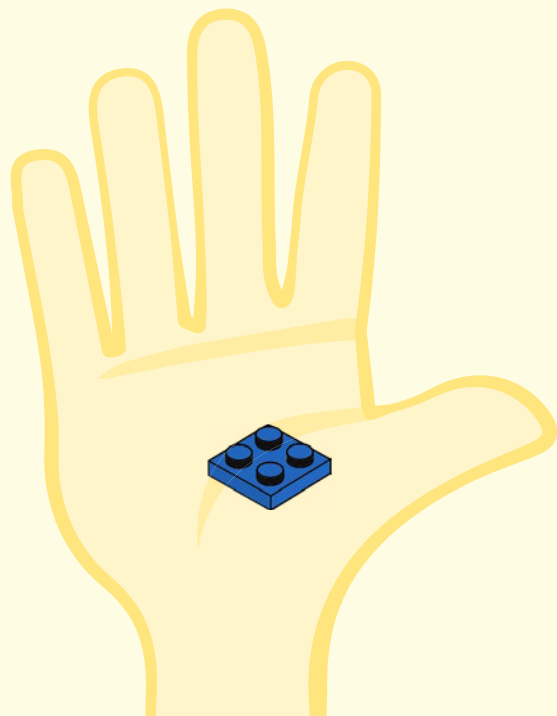
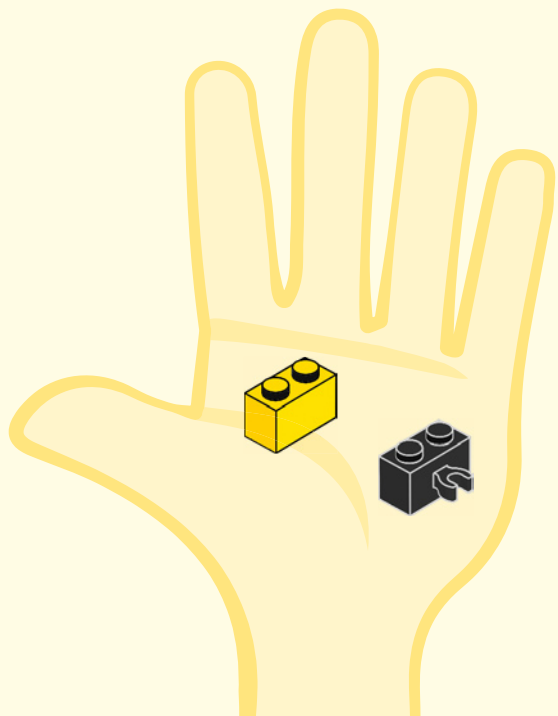

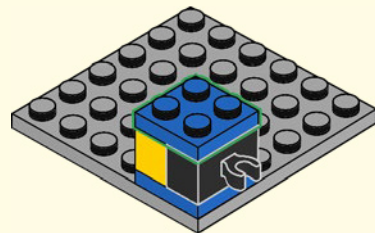
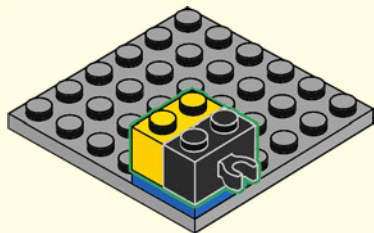

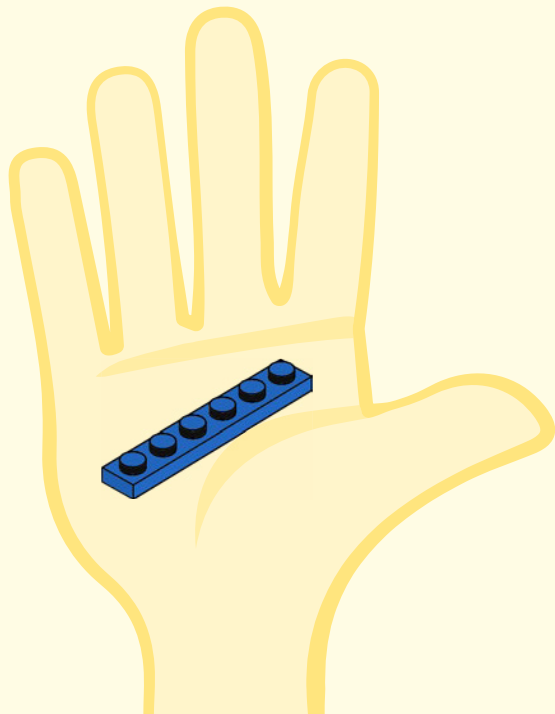
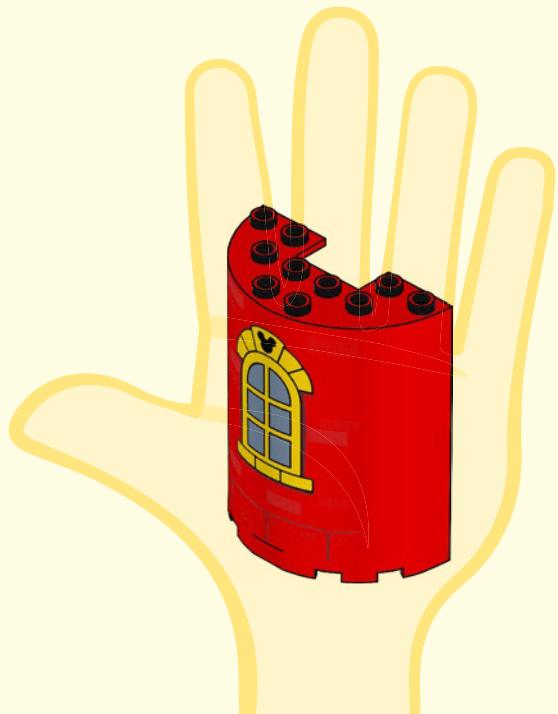



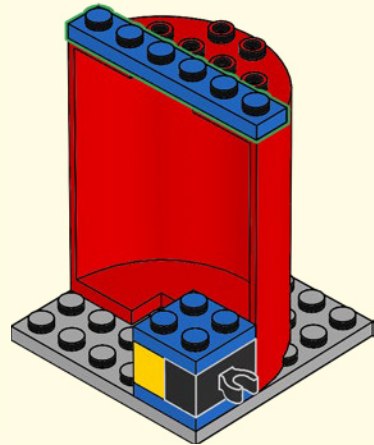
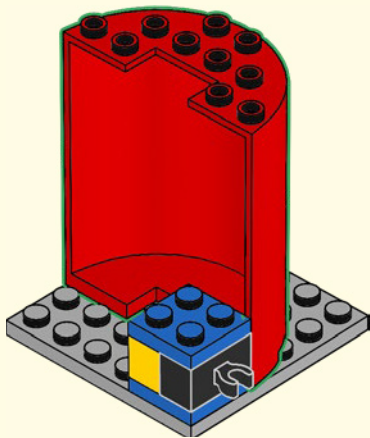

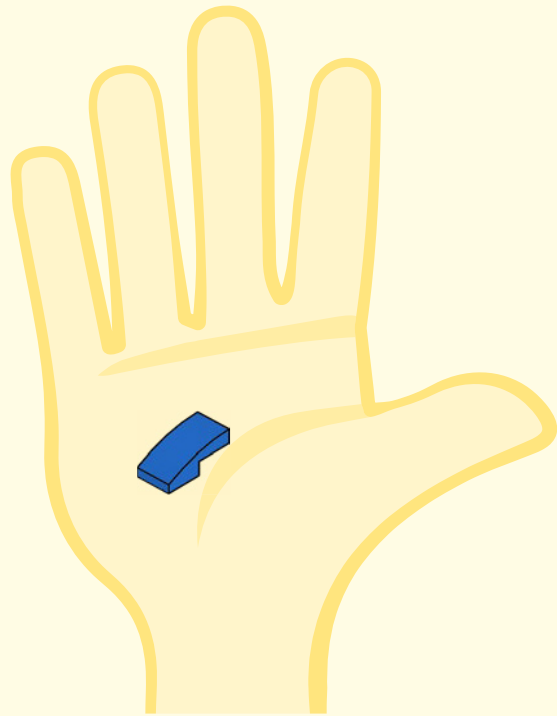
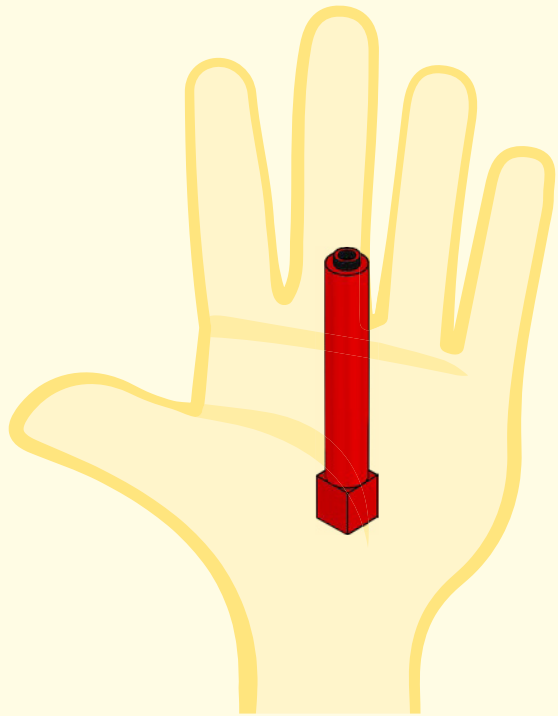

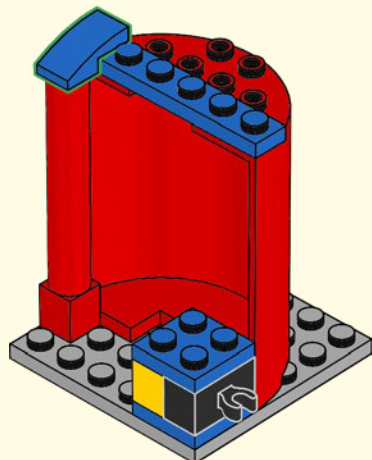
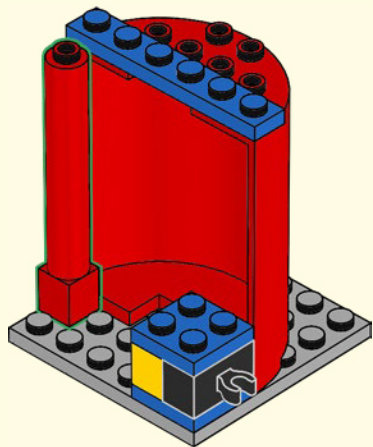

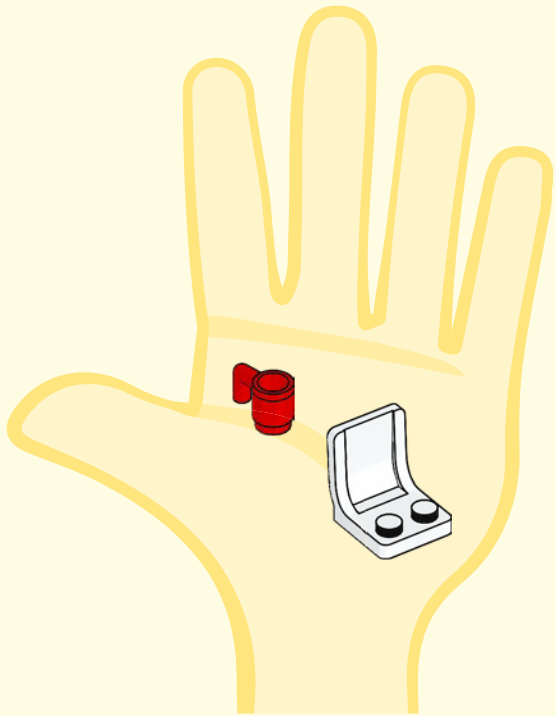

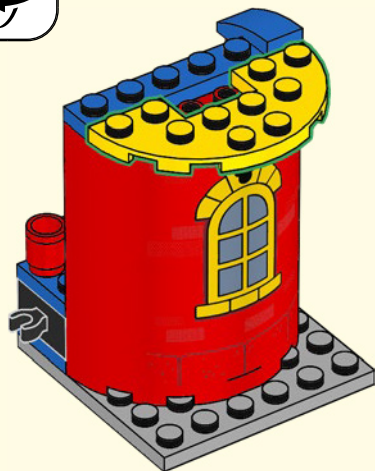
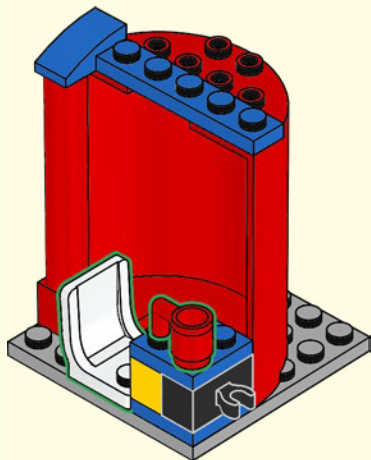

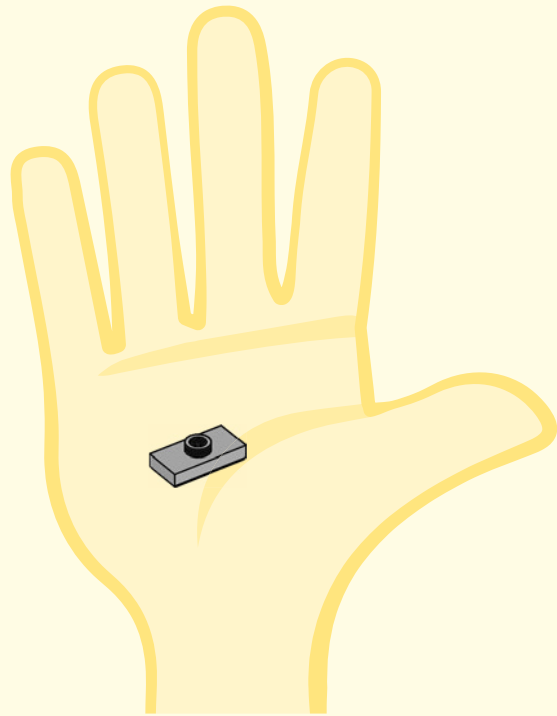
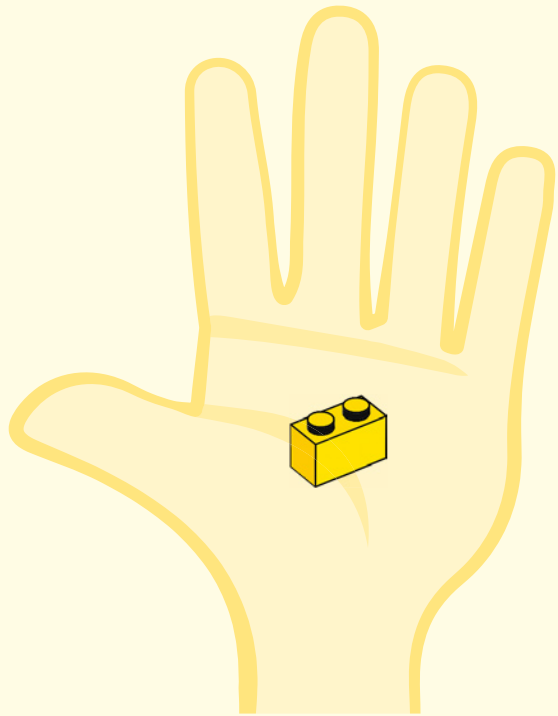

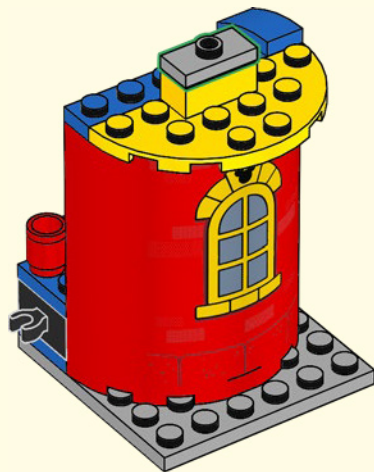
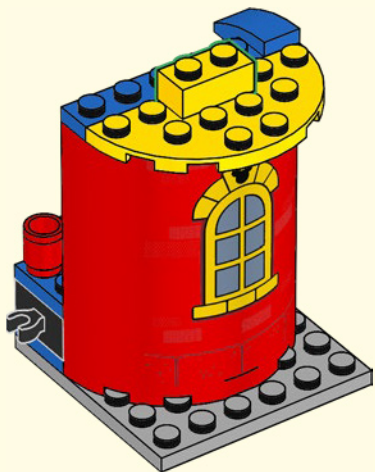

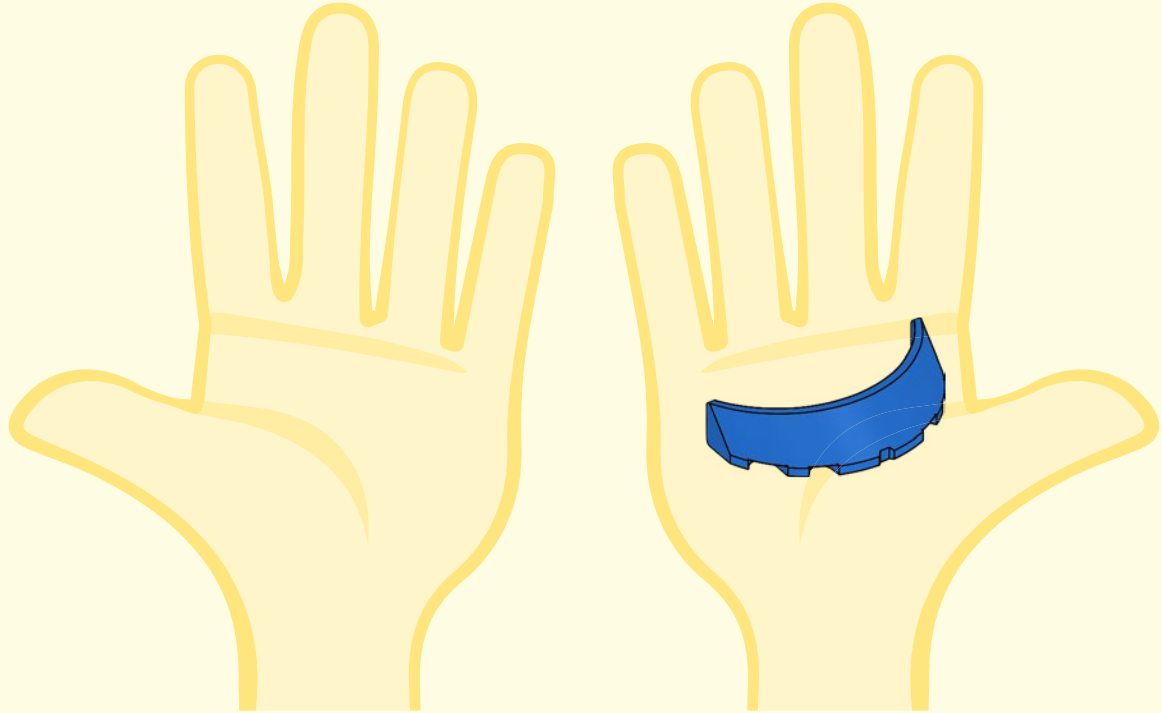



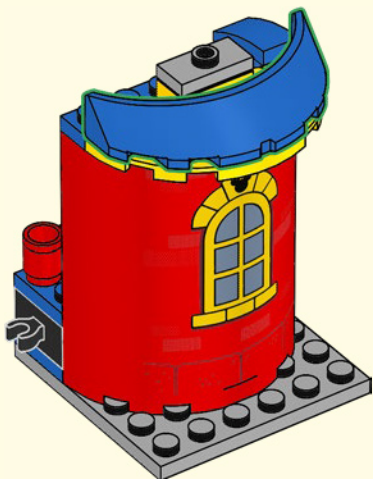

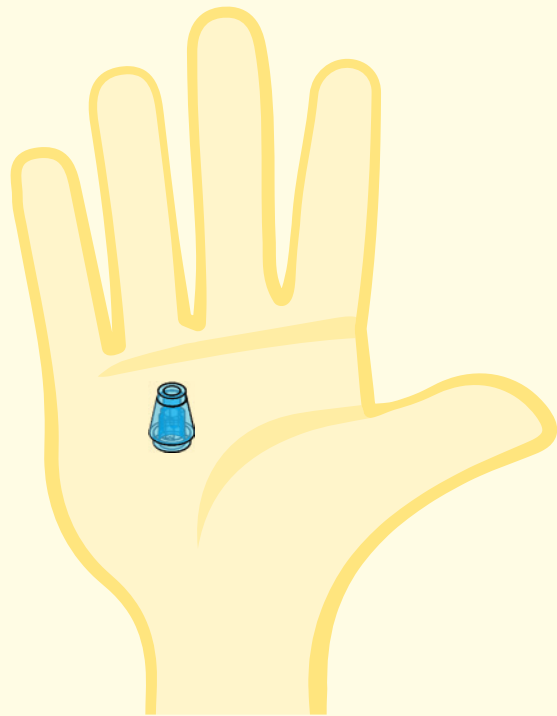
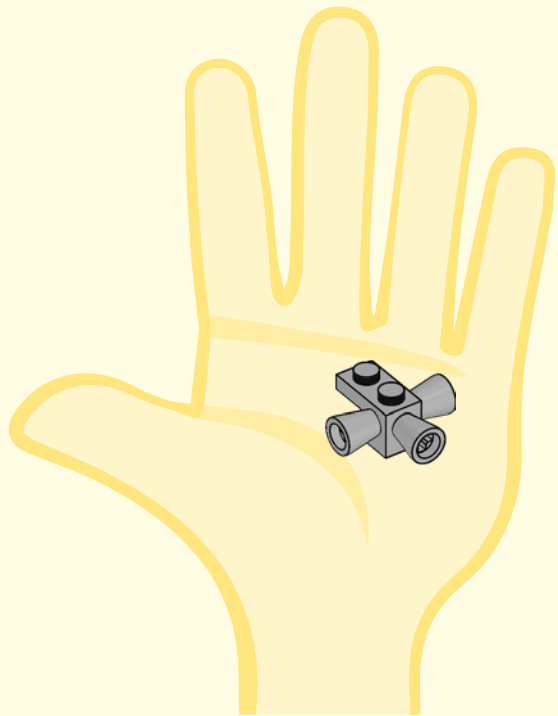

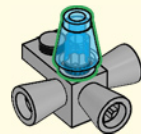
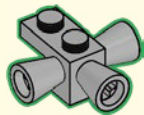

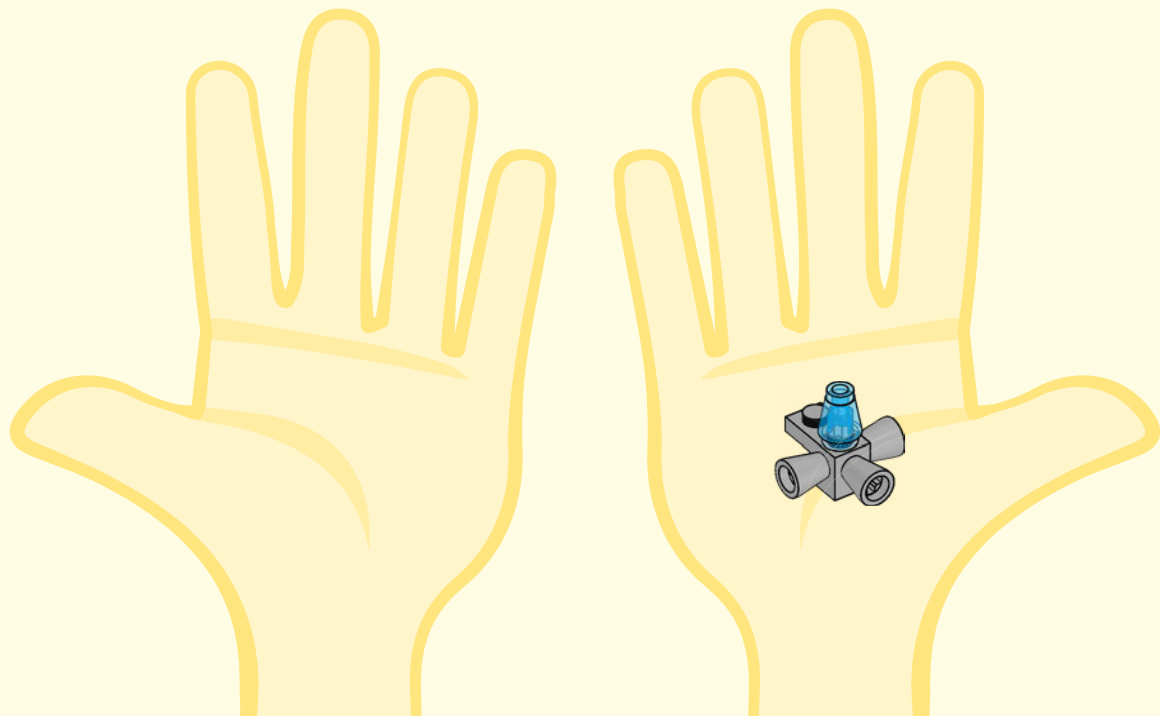

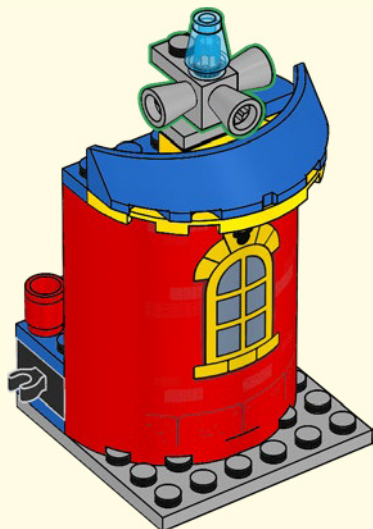

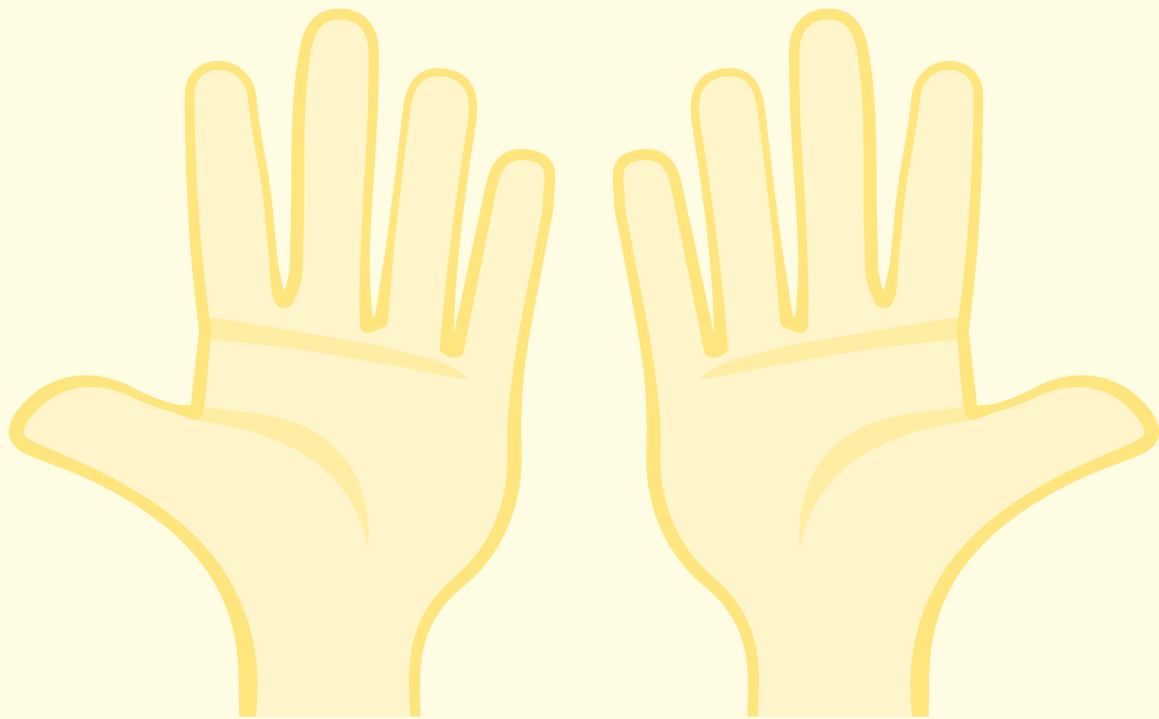

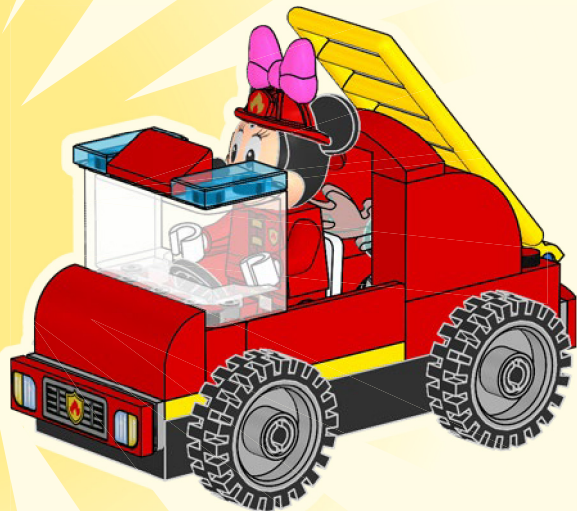
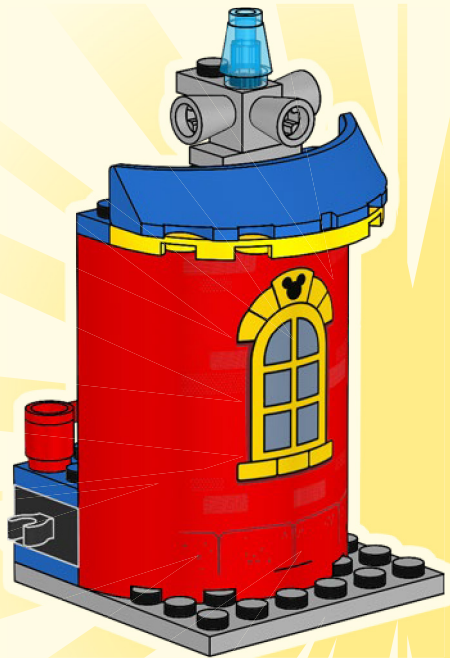



# Disney

 ©Disney  
www.disney.com

LEGO and the LEGO logo are trademarks of the LEGO Group.  
©2021 The LEGO Group. 6370283



10776



10774



10772

10775



10775



10773



Disney  
**MICKEY**  
AND FRIENDS







# Disney

10776



Check for compatibility  
Kompatibilität prüfen  
Vérifier la compatibilité  
Controlla la compatibilità  
Comprueba tu compatibilidad  
Verificar a compatibilidade  
Ellenőrizd a kompatibilitást  
Pārbaudīt saderību  
检查兼容性

[LEGO.com/devicecheck](https://LEGO.com/devicecheck)



乐高®拼搭指引



LEGO® Building Instructions



Download on the  
App Store



GET IT ON  
Google Play



腾讯应用宝  
安卓应用商店



Apple and the Apple logo are trademarks of Apple Inc.  
Google Play and the Google Play logo are trademarks of Google LLC.  
Tencent and the Tencent logo are trademarks of Tencent Inc.





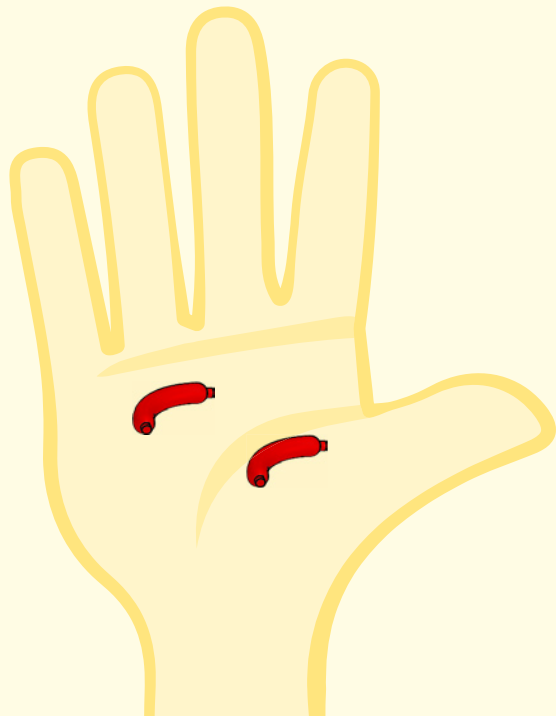

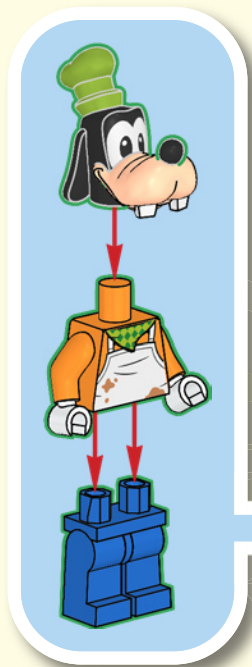

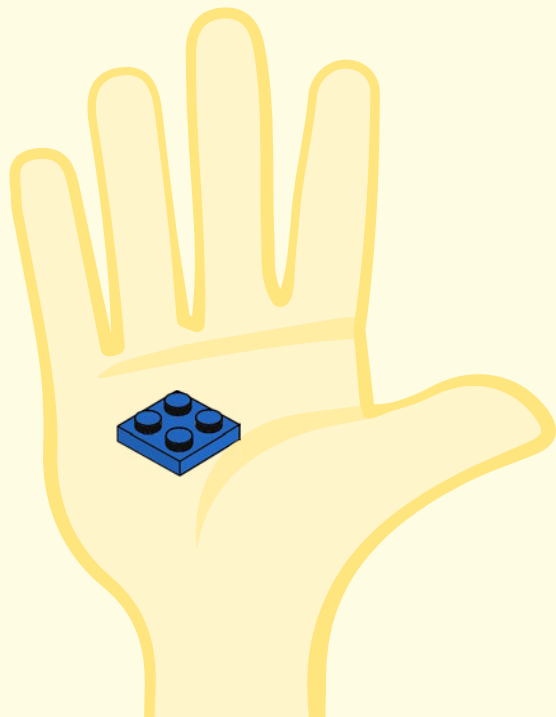
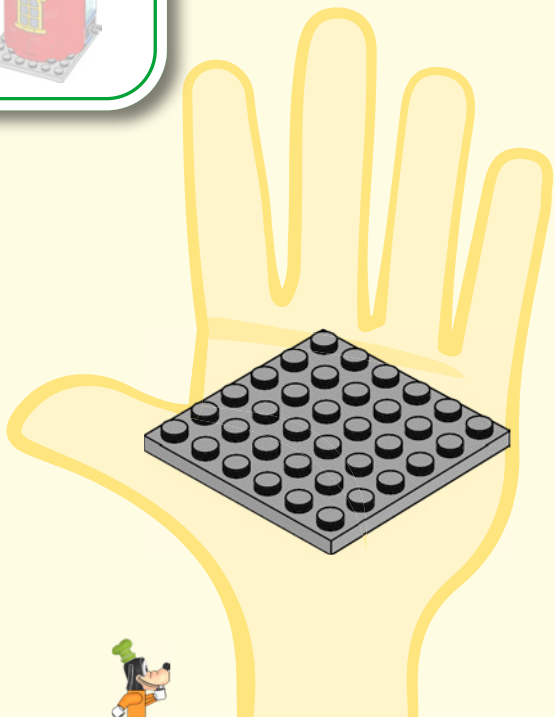



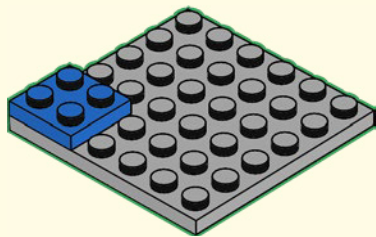

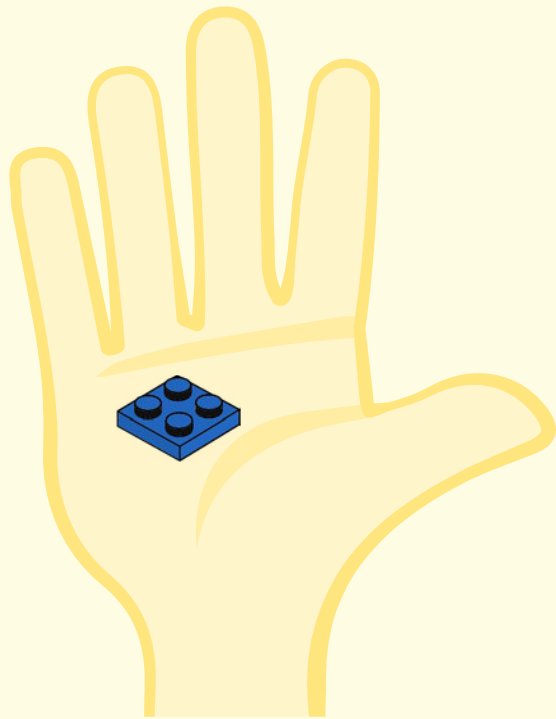
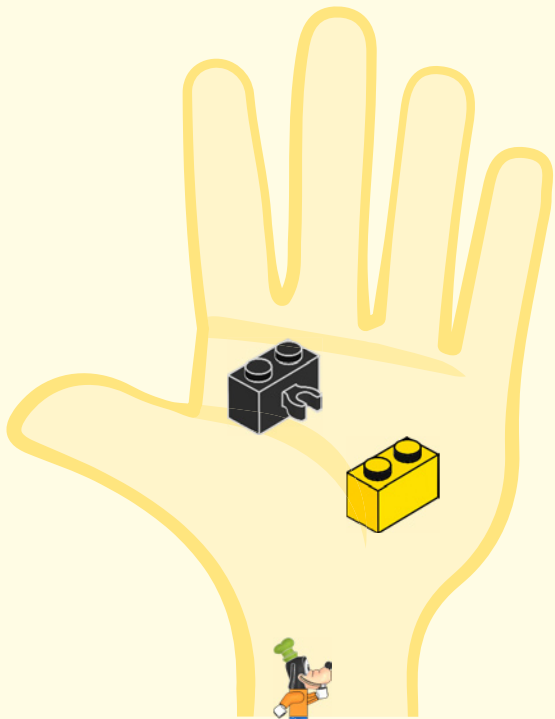

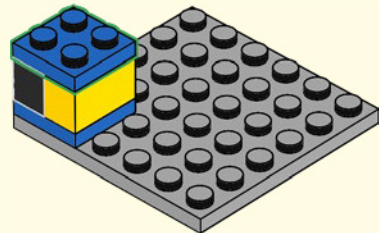
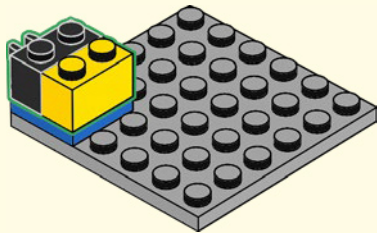

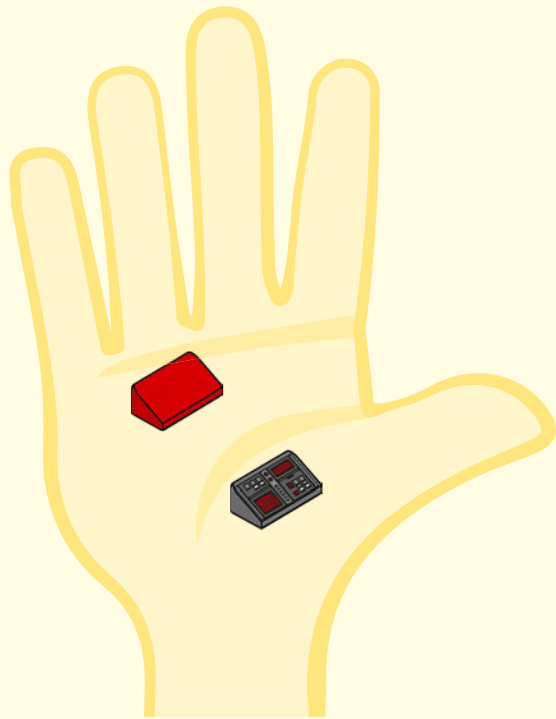
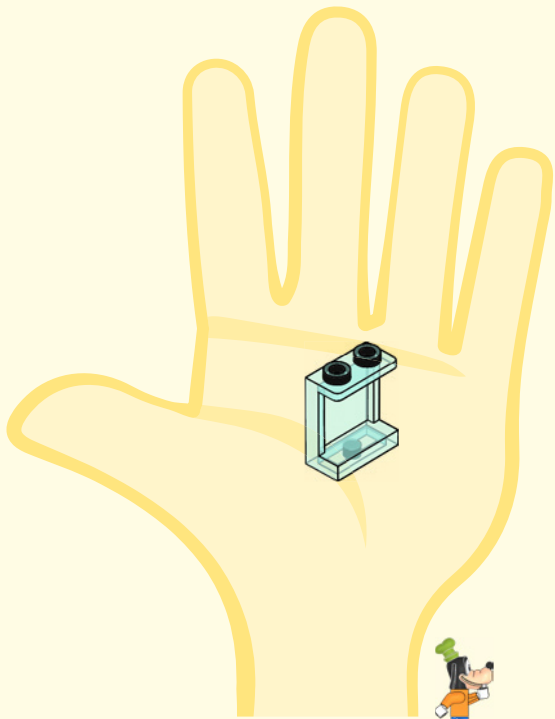

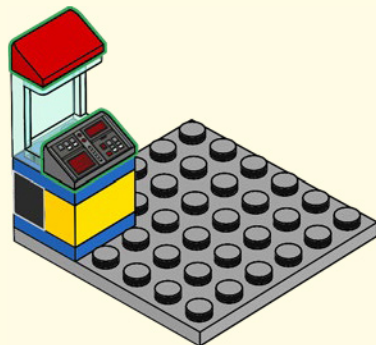
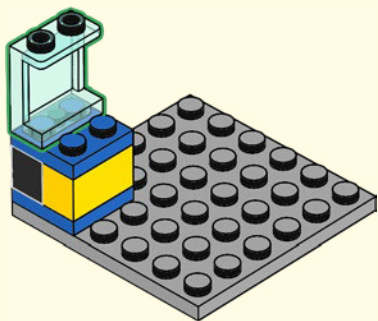

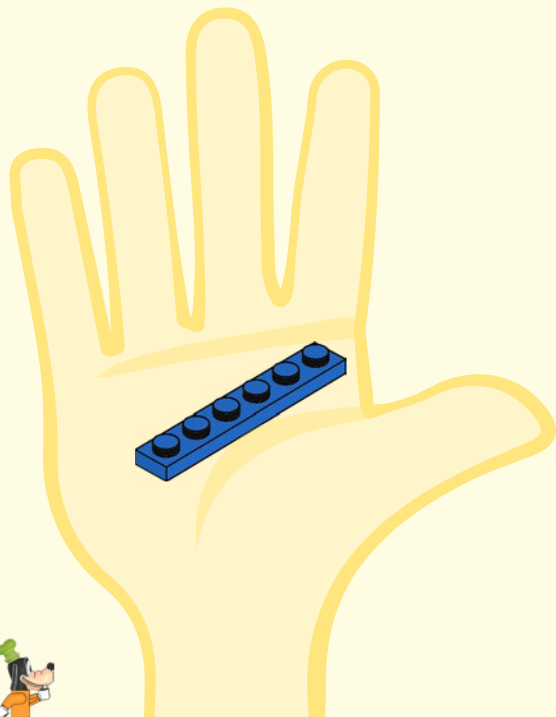
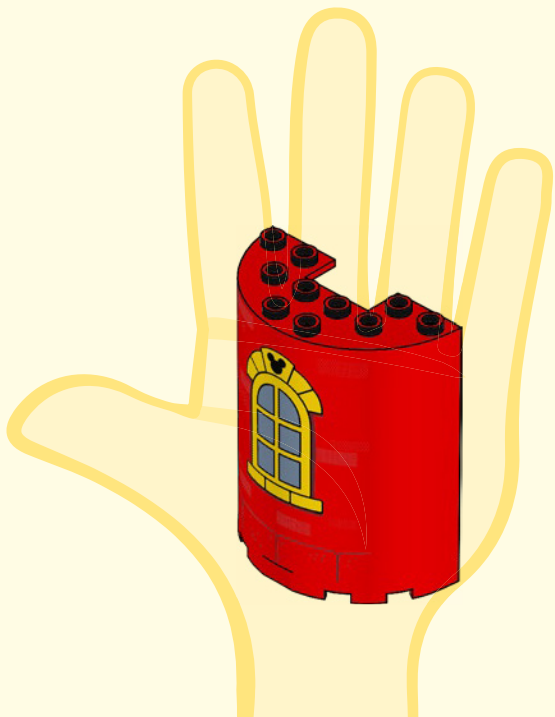

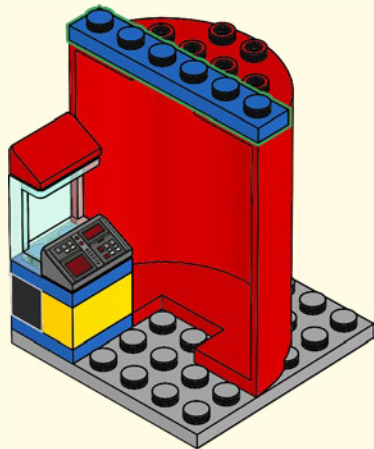
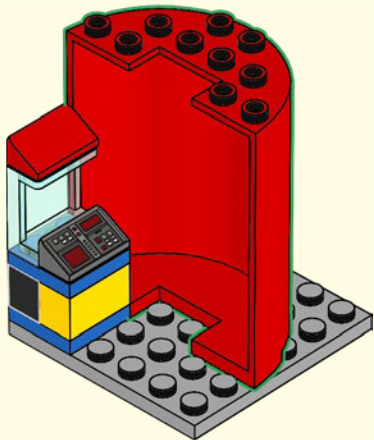

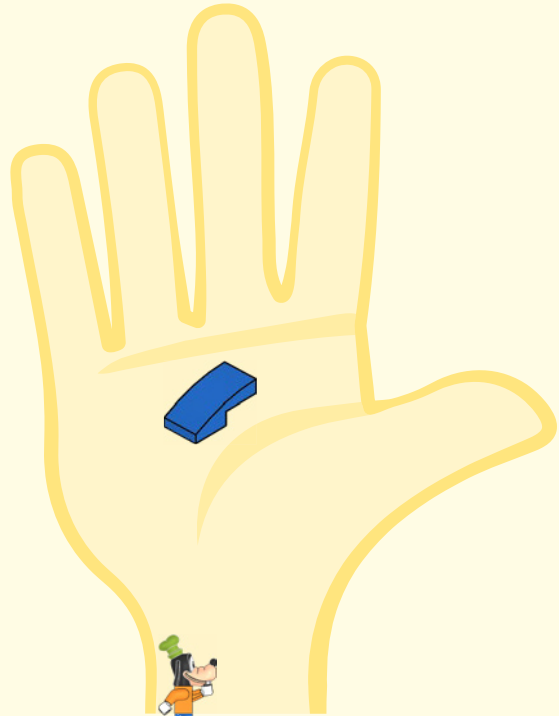
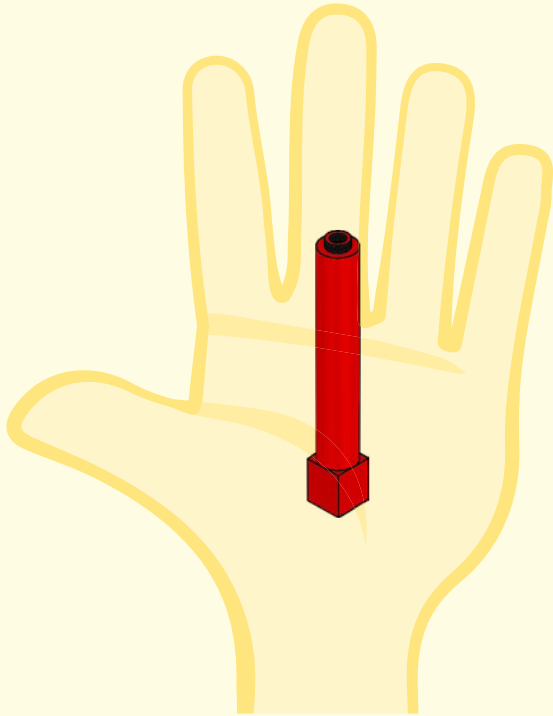



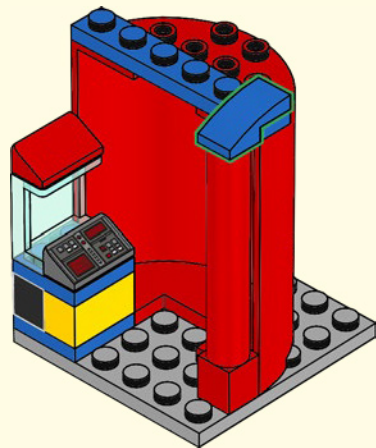
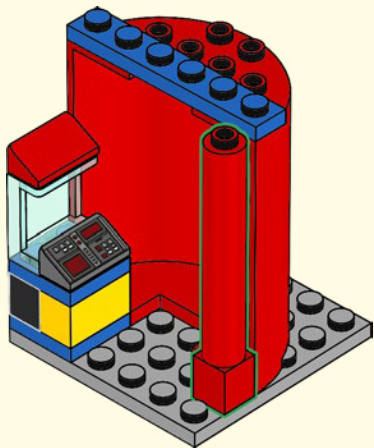

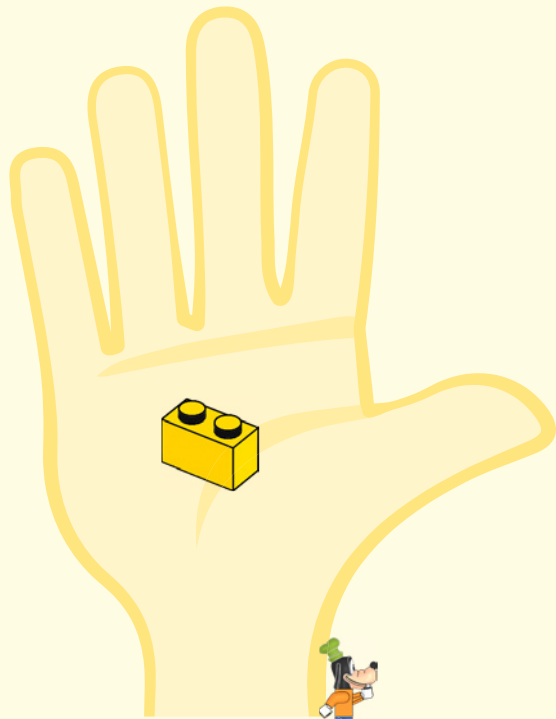

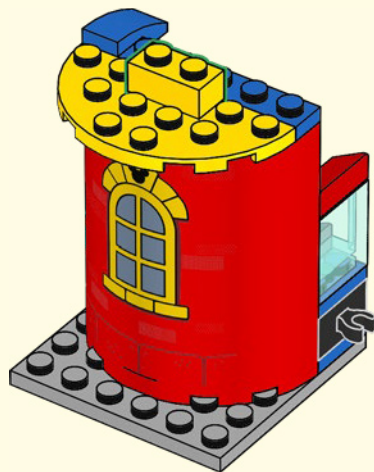
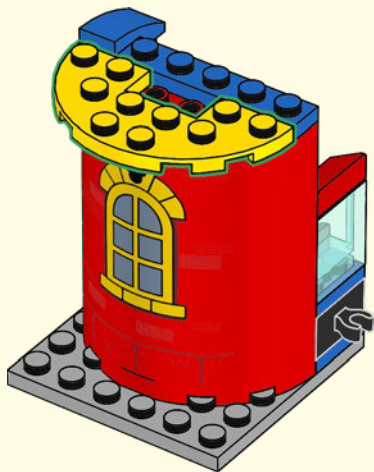

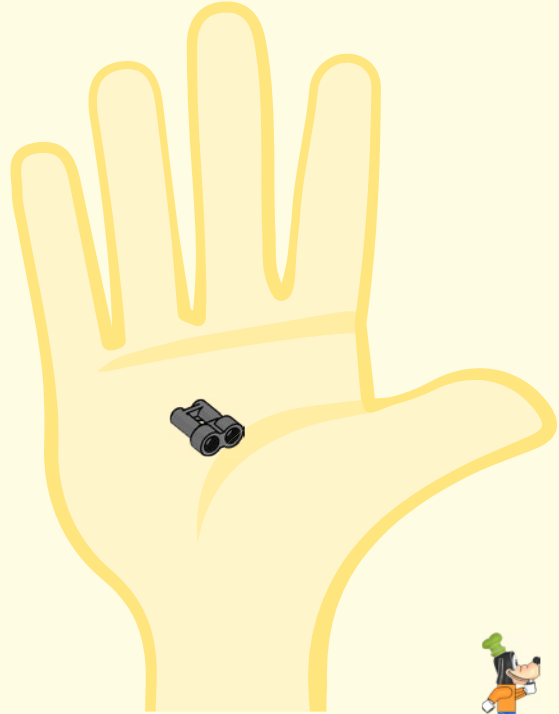
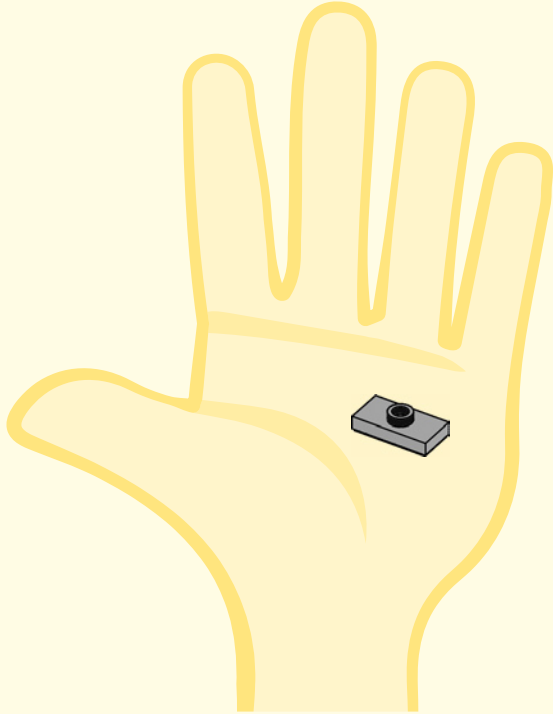

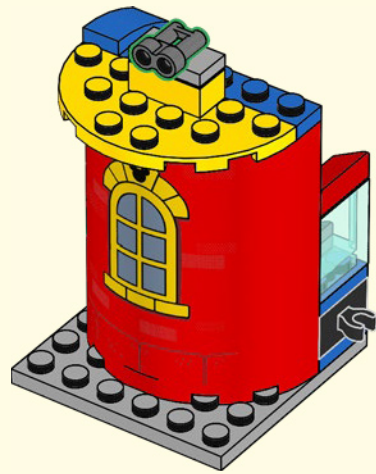
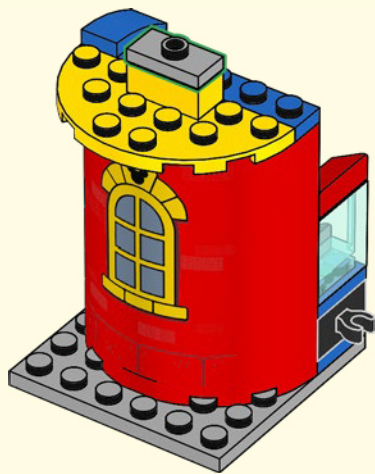

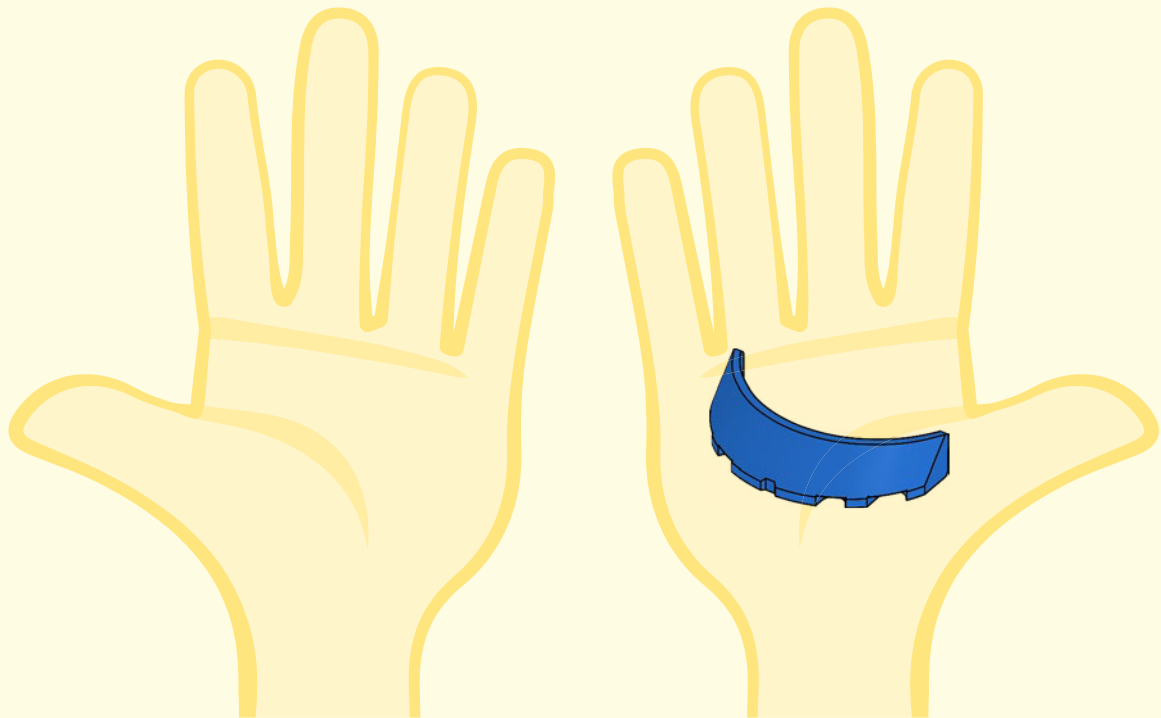

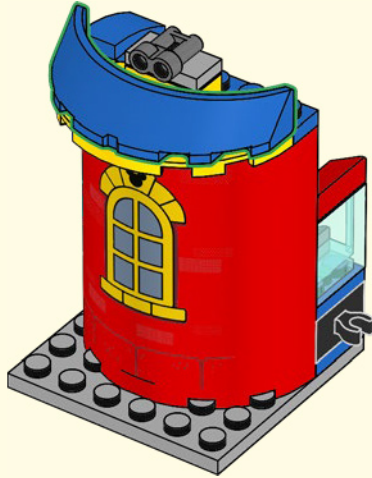

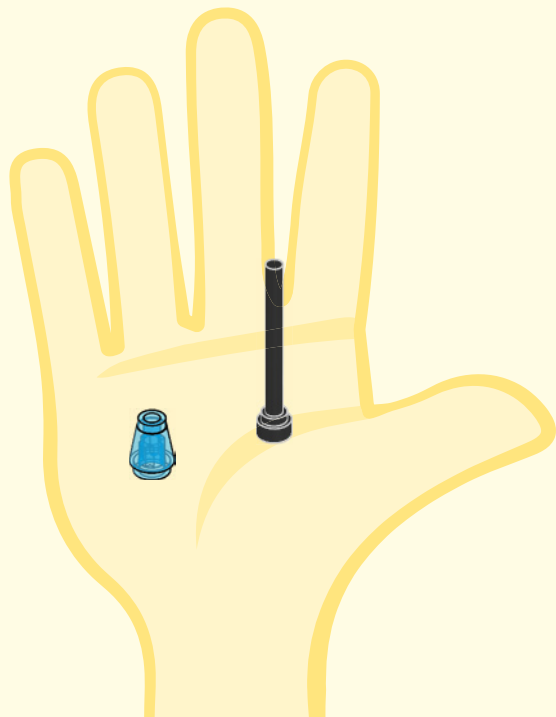
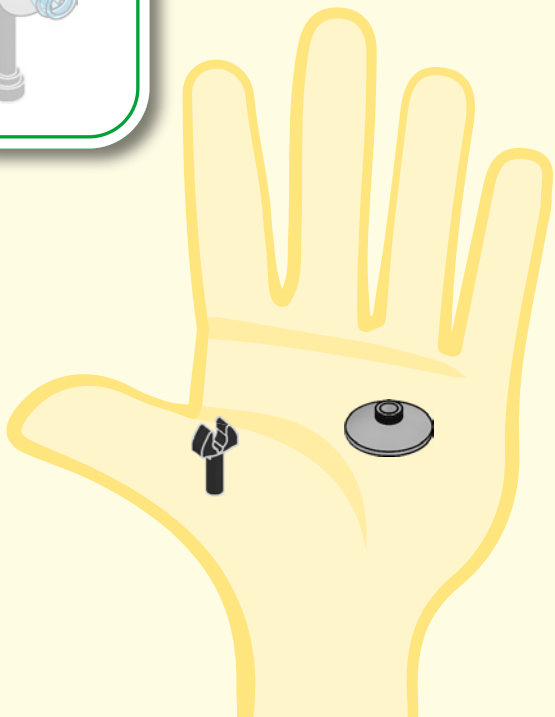
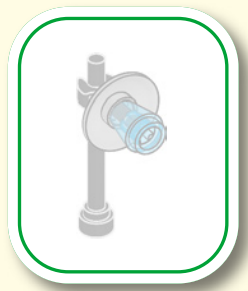





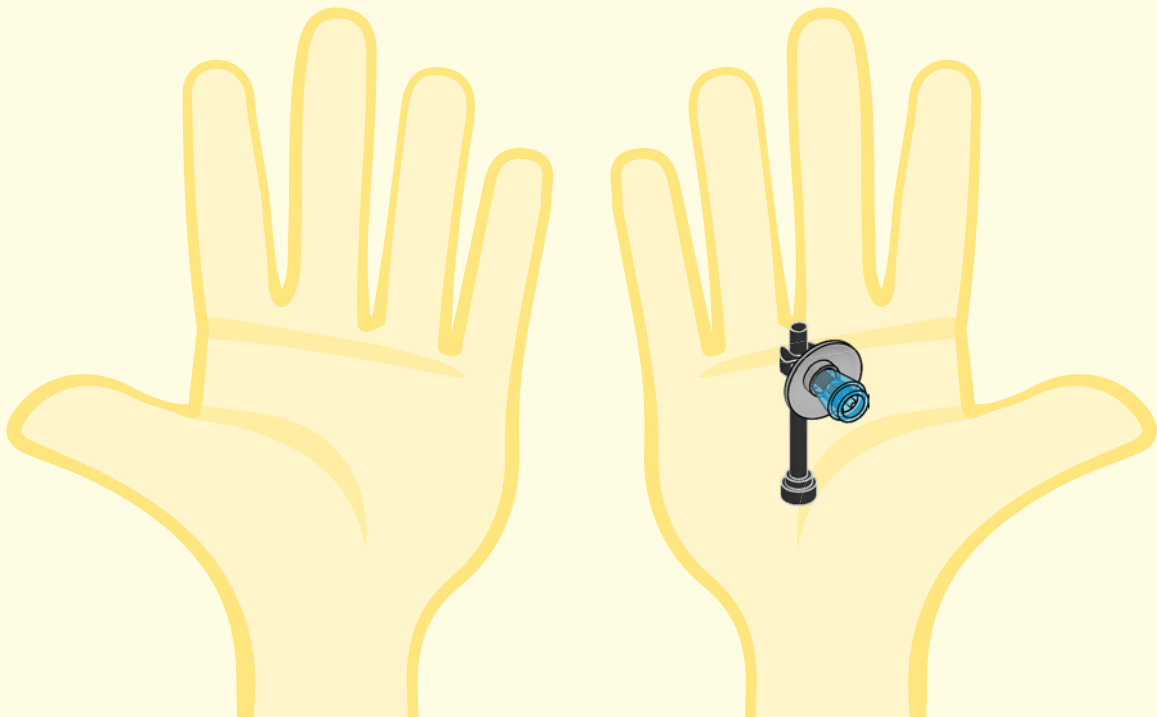



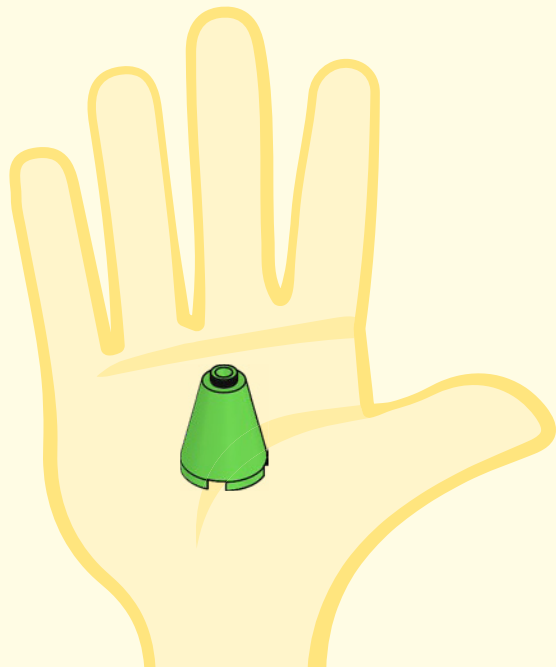

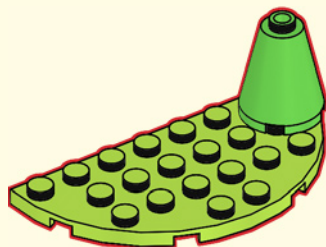

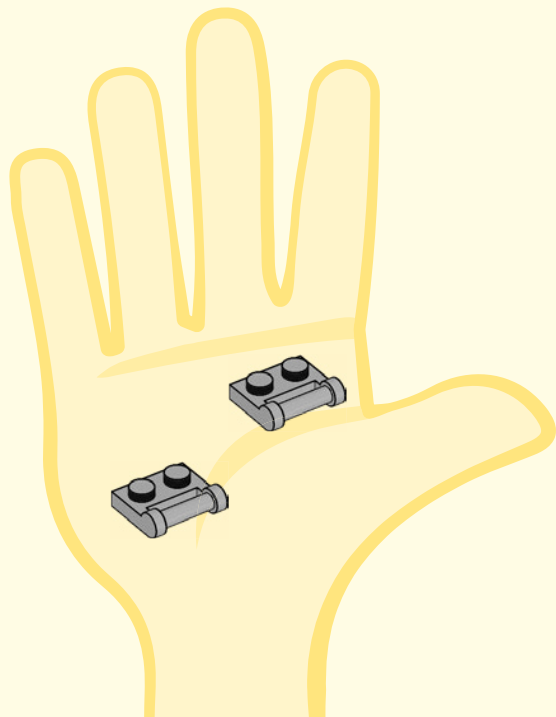
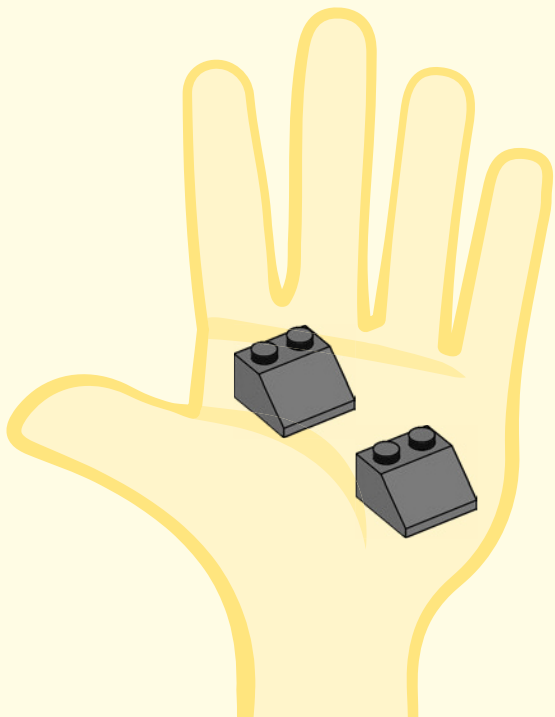

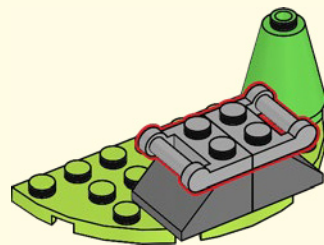
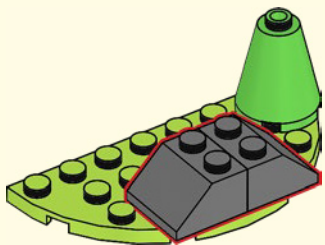

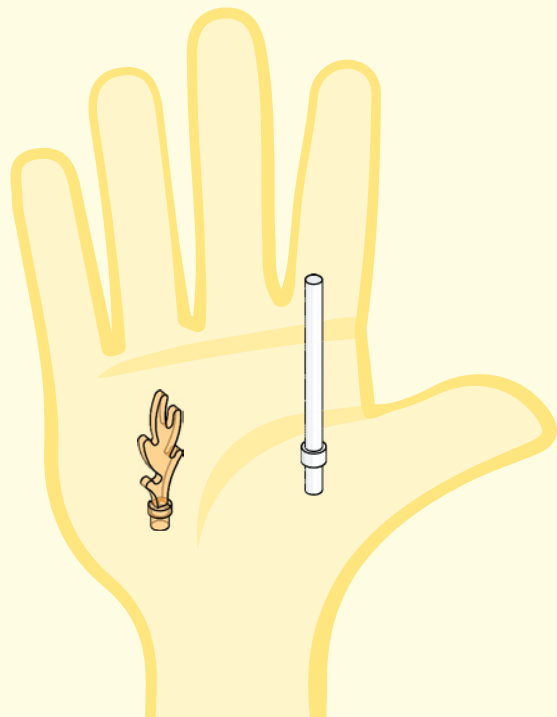
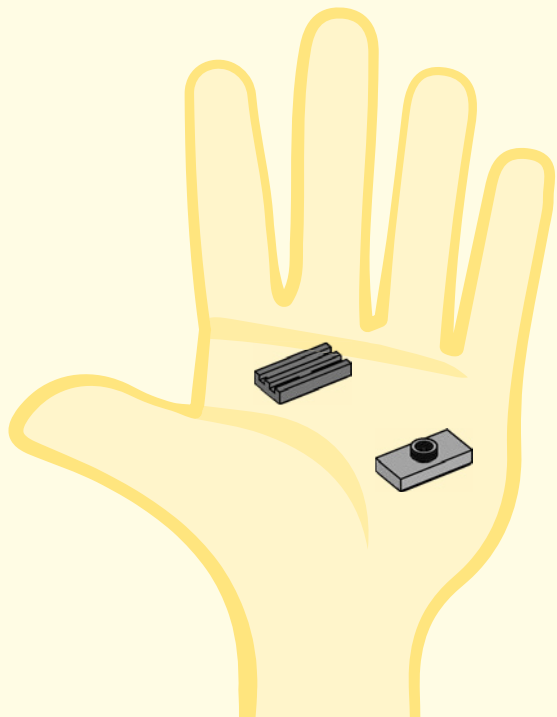



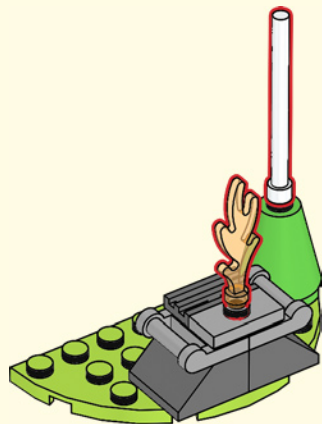
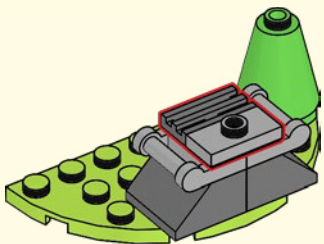

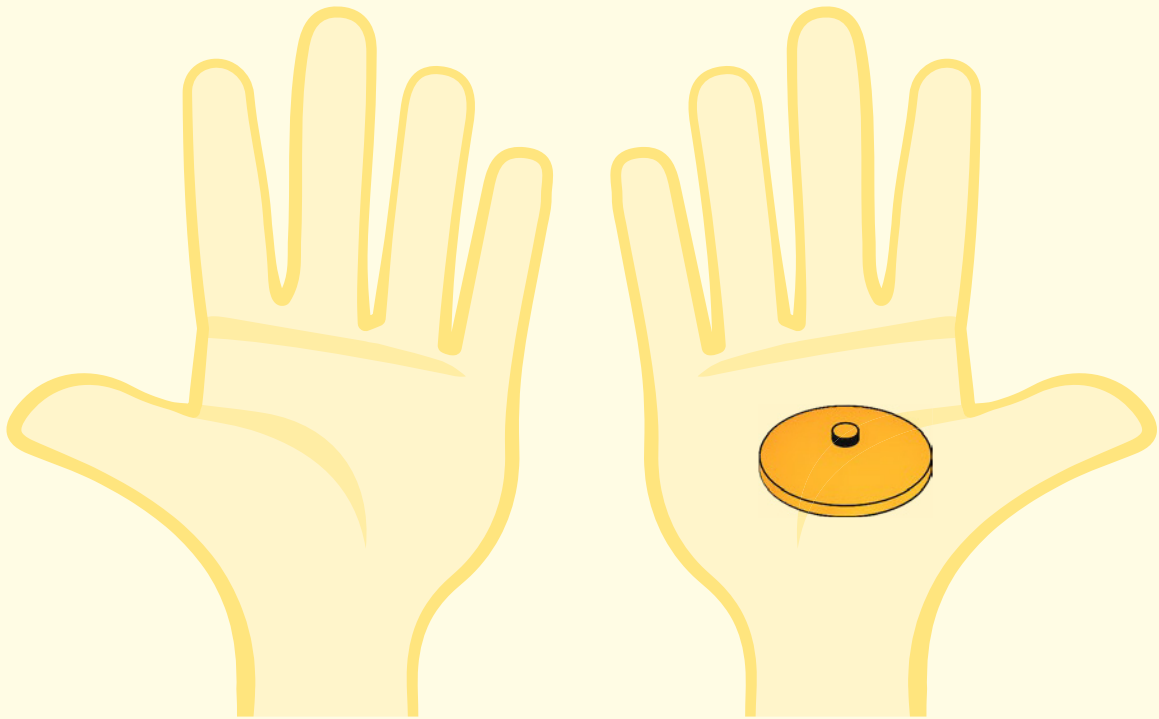

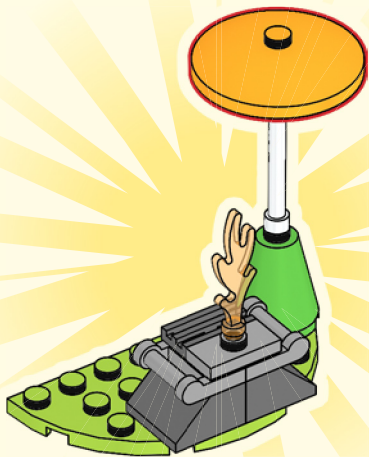

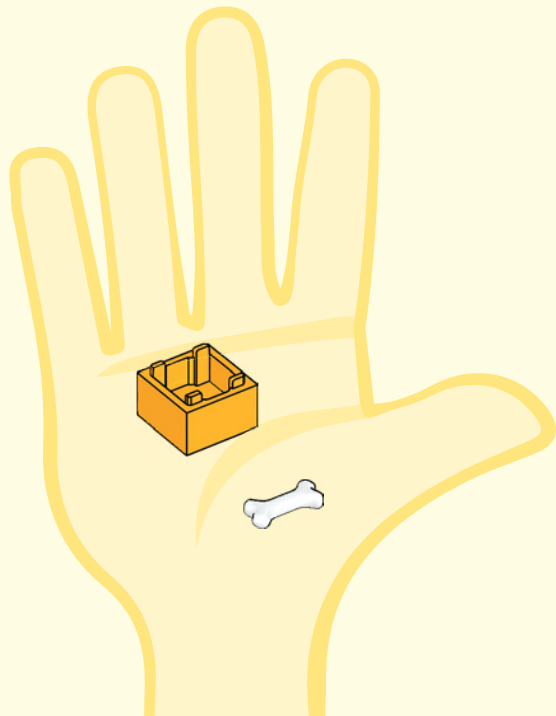



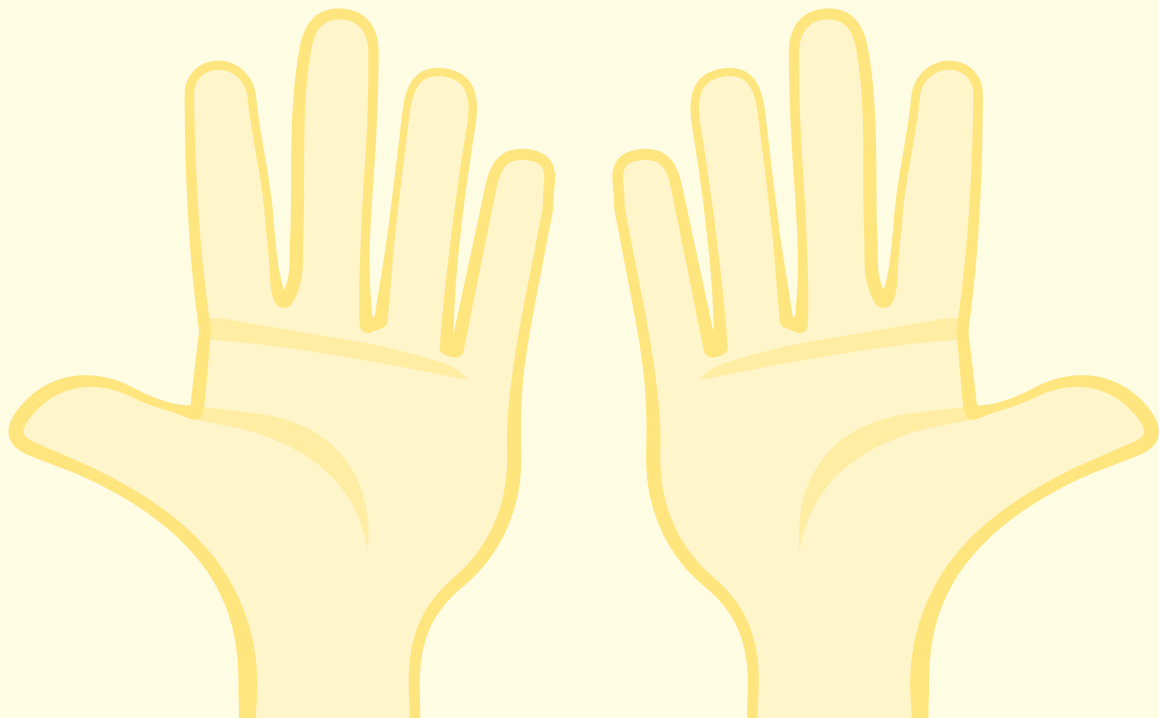



Disney  
**MICKEY**  
AND FRIENDS

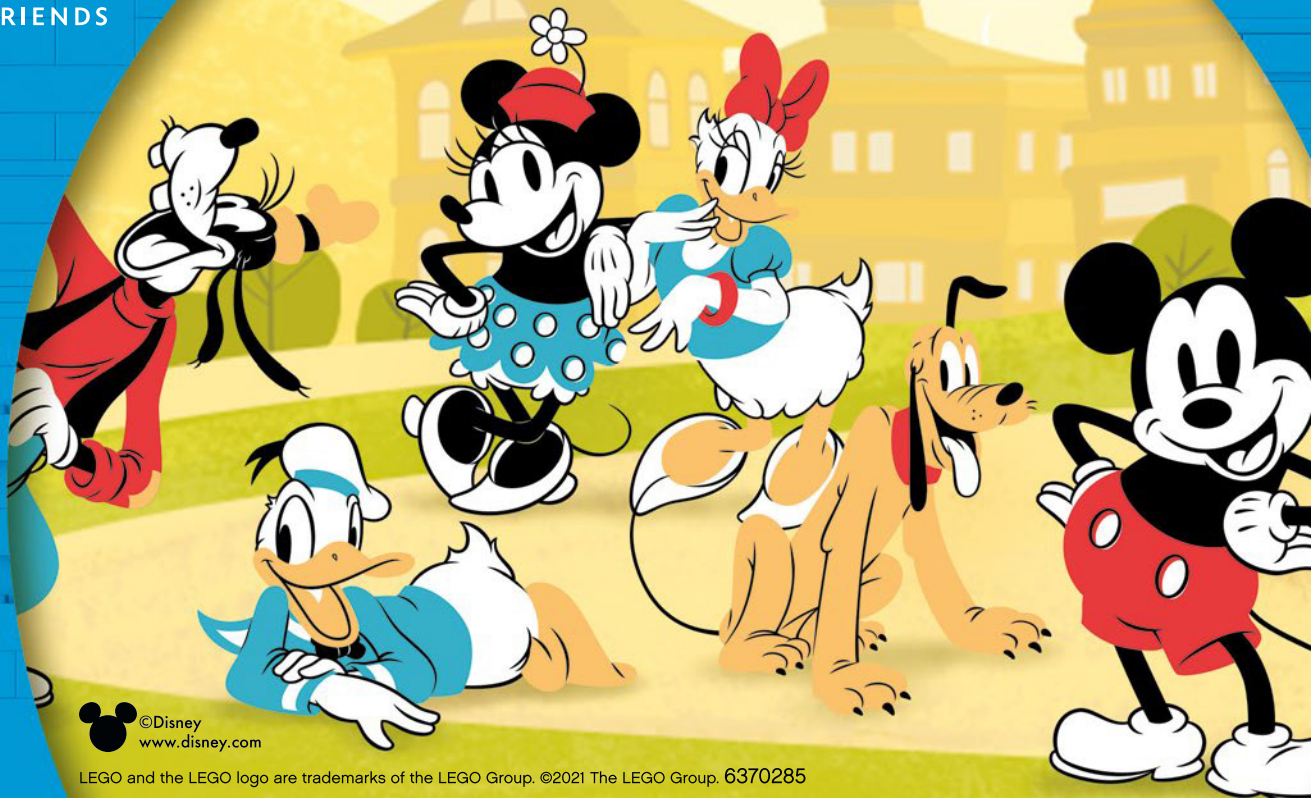

 ©Disney  
[www.disney.com](http://www.disney.com)

LEGO and the LEGO logo are trademarks of the LEGO Group. ©2021 The LEGO Group. 6370285