

1

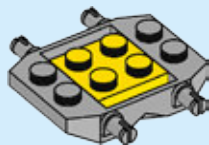

2



3

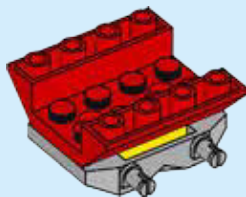

4

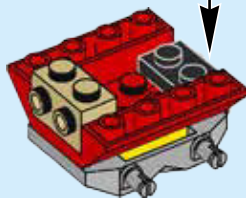
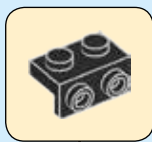

5

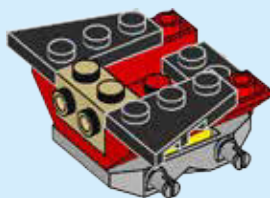

6

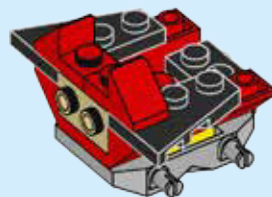

7

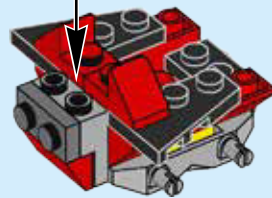
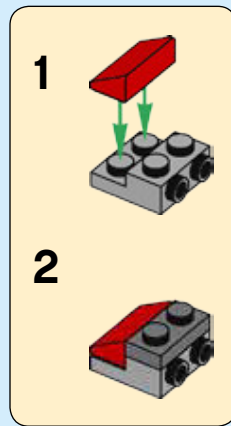

8

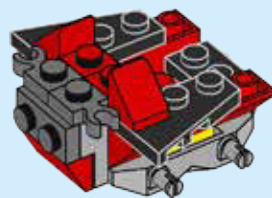

9

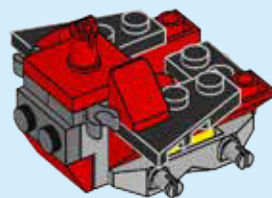

10

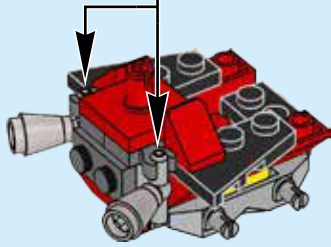
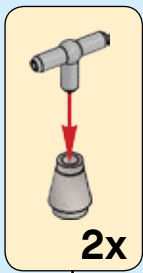

11

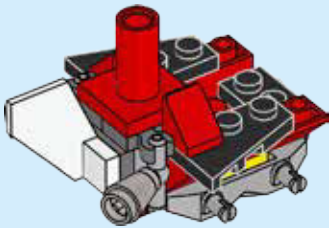

12

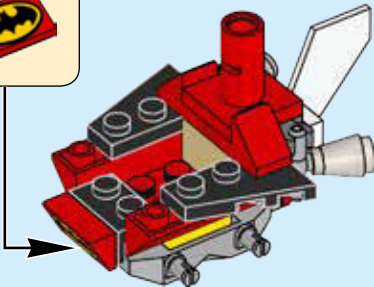
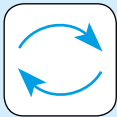

13

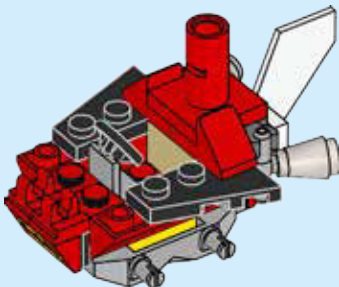

14

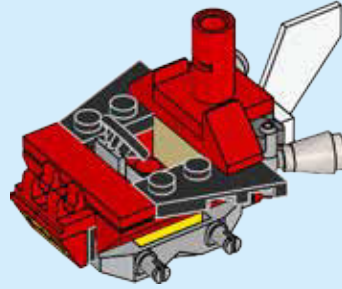

15

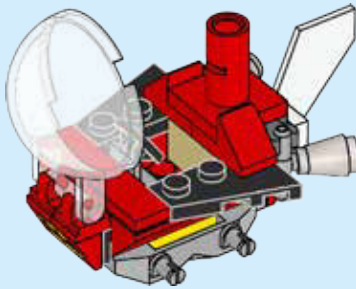

16

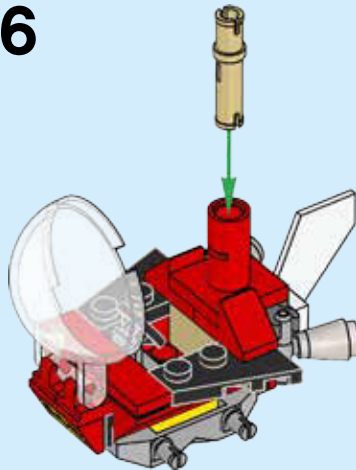

17

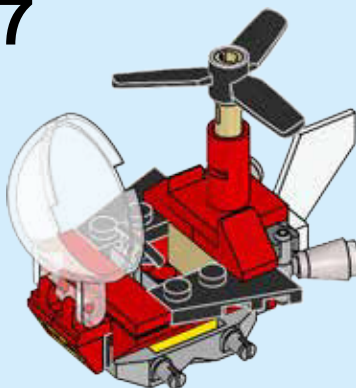

18

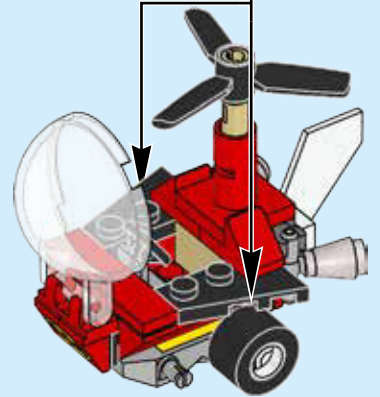
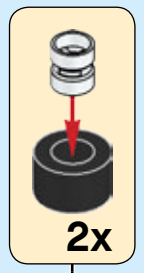

19

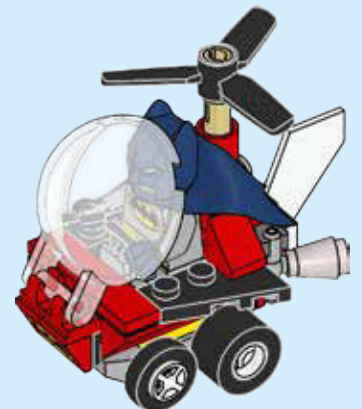
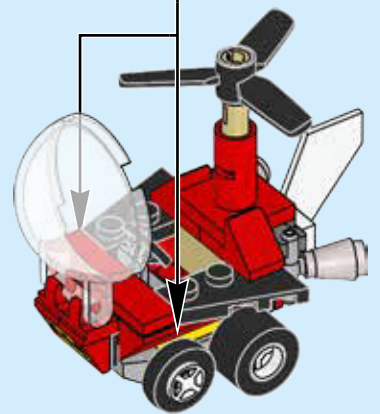
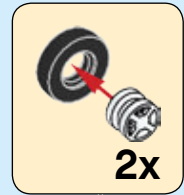

LEGO.com/service

LEGO and the LEGO logo are trademarks of the LEGO Group. ©2017 The LEGO Group. 6187690

DC All DC characters and elements © & TM DC Comics.

WB SHIELD: TM & © WBEI. (s17)

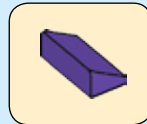
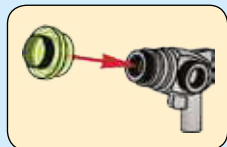
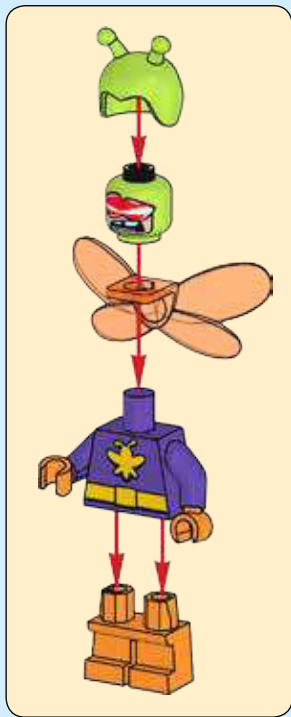

5

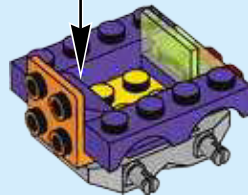

6

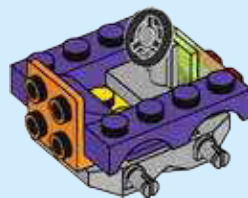

7

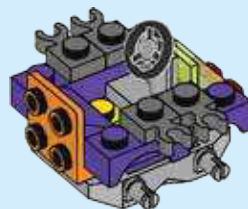

8

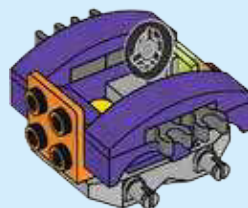

1

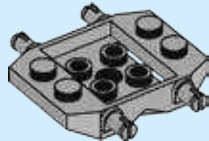

2

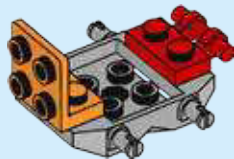

3

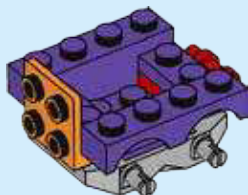

4

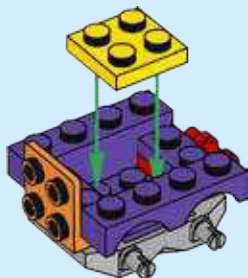

9

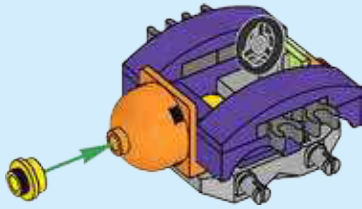

10

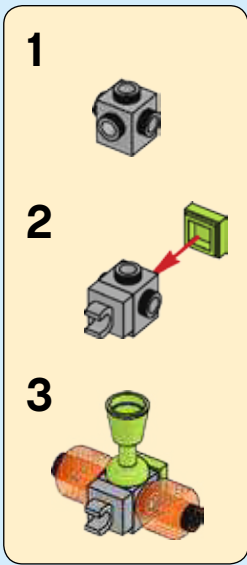
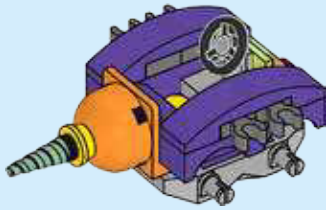

11

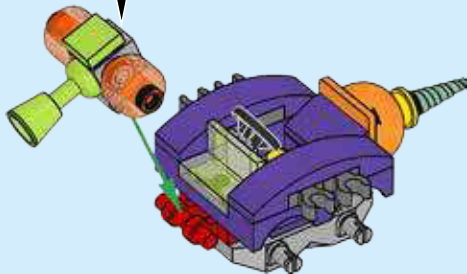

12

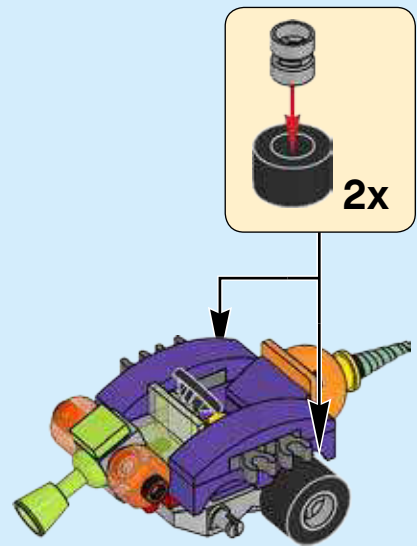

13

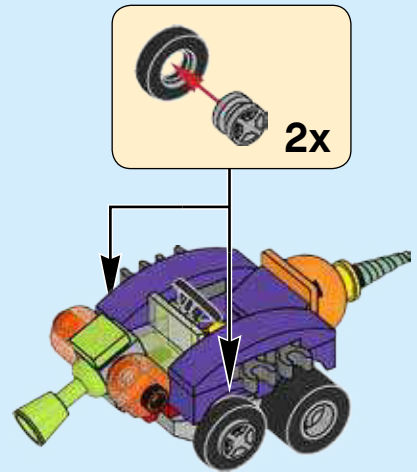

14

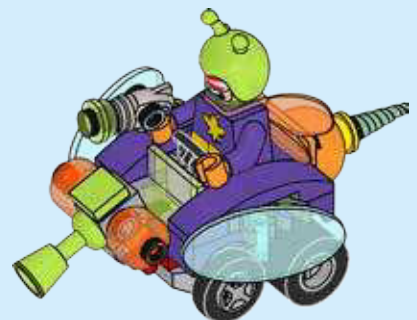



DC COMICS SUPER HEROES

LEGO.com/DCSUPERHEROES

76069

LEGO and the LEGO logo are trademarks of the LEGO Group. ©2017 The LEGO Group.

DC All DC characters and elements © & ™ DC Comics.

WB SHIELD: TM & © WBEI.
(s17)

6187702



Terms & Conditions apply

LEGO.com/productfeedback

GEWINNE



Erzähle uns auf
www.LEGO.com/productfeedback

etwas über die Erfahrungen, die du mit diesem LEGO® Set gemacht hast, und sichere dir die Chance auf einen coolen LEGO Preis!

Es gelten die Teilnahmebedingungen

GAGNE



Rends-toi sur
www.LEGO.com/productfeedback

et donne-nous quelques commentaires sur ce produit LEGO® pour avoir une chance de gagner un prix LEGO!

Voir Conditions Générales

GANA



Visita
www.LEGO.com/productfeedback

y envíanos tu opinión acerca de este set LEGO®. ¡Participarás en el sorteo de un premio LEGO!

Términos y Condiciones aplicables

获取奖品



登录
www.LEGO.com/productfeedback

给出关于此乐高®套装的简短反馈，就有机会获得炫酷乐高奖品

《条款及条件》适用

| | | | | | | | | | | | |
|------------|------------|------------|------------|------------|------------|------------|------------|------------|------------|------------|------------|
| | | | | | | | | | | | |
| 1x 6170413 | 1x 6170940 | 1x 4514554 | 1x 4526984 | 1x 6050850 | 1x 4180508 | 1x 6076609 | 1x 4537251 | 2x 6011380 | 1x 6071229 | 1x 4211063 | 1x 6144650 |
| | | | 2x 4597713 | 2x 302224 | 1x 4288960 | | | 2x 4211506 | | | |
| 1x 6170415 | 1x 6170961 | 1x 243121 | 2x 6053011 | 1x 4650620 | 1x 4180536 | | 2x 6170467 | 2x 6011375 | 1x 4654577 | | |
| 1x 4520155 | 1x 6170446 | 1x 4658975 | 1x 4140585 | | 4x 4508215 | 1x 6106160 | 1x 4532970 | 1x 4211511 | 1x 6046398 | | |
| | | | 1x 246021 | 1x 4599984 | 1x 6016172 | 2x 6028411 | 1x 6061676 | 2x 4211508 | | | |

Customer Service
Kundenservice
Service Consommateurs
Servicio Al Consumidor

LEGO.com/service or dial

| | | | | | | | | |
|-------------------|------------------|--|--|--|--|--|--|--|
| | | | | | | | | |
| : 00800 5346 5555 | | | | | | | | |
| | : 1-800-422-5346 | | | | | | | |

LEGO

DC COMICS
**SUPER
HEROES**

**MIGHTY
MICROS**



LEGO.com/DCSUPERHEROES

DC All DC characters and elements © & ™ DC Comics.

WB SHIELD: TM & © WBEI.
(s17)

Apple and the Apple logo are trademarks of Apple Inc., registered in the U.S. and other countries. App Store is a service mark of Apple Inc.

Google Play is a trademark of Google Inc.

Ask parents' permission first.
Bitte frage erst deine Eltern um Erlaubnis.
Demande d'abord l'autorisation d'un parent.
Pide antes permiso a tus padres.
Pede primeiro permissão aos teus pais.
Először kérj engedélyt a szüleidtől!
先请求家长的许可。



Download on the
App Store

GET IT ON
Google play



LEGO

DC COMICS
**SUPER
HEROES**

76054

76055

76053



76055

76054

76053

DC BATMAN and all related characters and elements © & ™ DC Comics and Warner Bros. Entertainment Inc.

WB SHIELD: TM & © WBEI.
(s17)

