



DC COMICS  
**SUPER  
HEROES**

76070



**1**

6187718

**1**



**5**

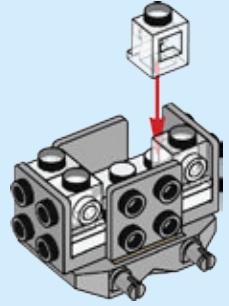

**2**

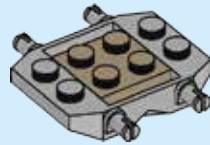

**6**

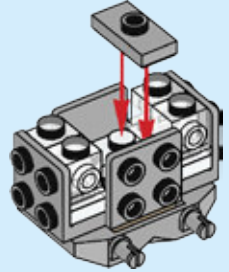

**3**

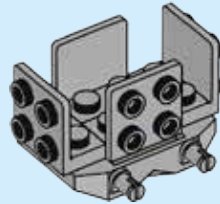

**7**

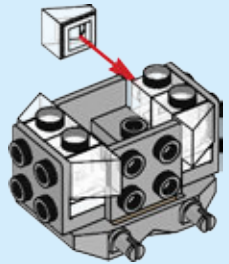

**4**



**8**

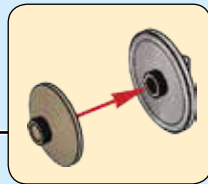
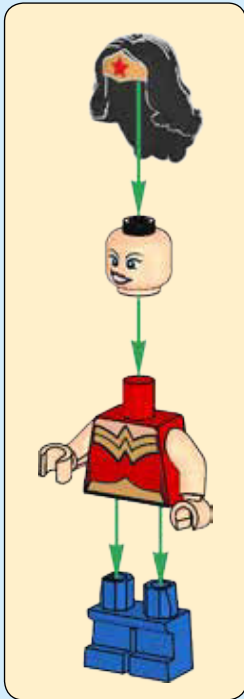
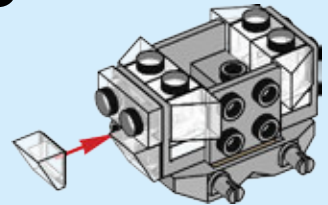

**9**

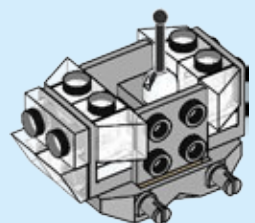

10

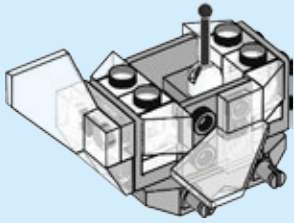

11

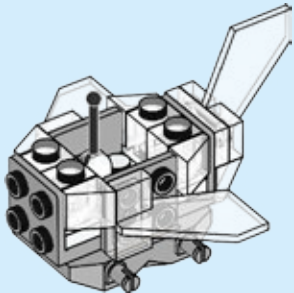
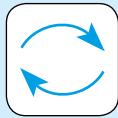

12

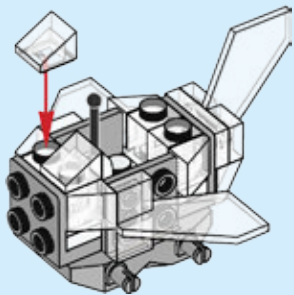

13

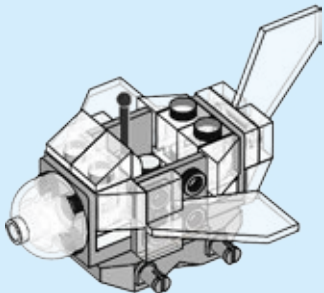

14

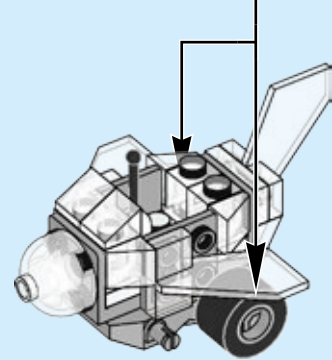
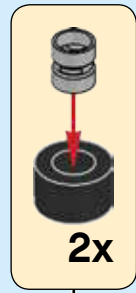

15

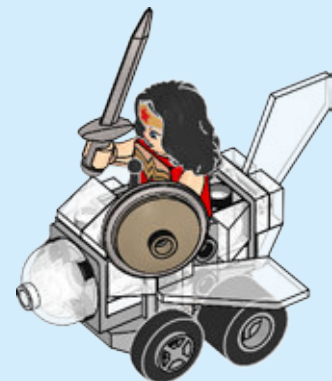
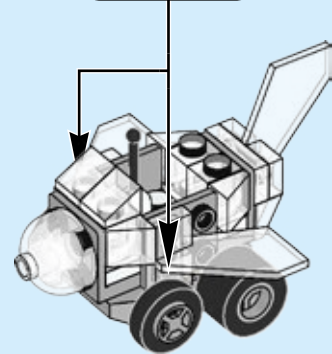
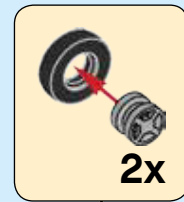

LEGO.com/service

LEGO and the LEGO logo are trademarks of the LEGO Group. ©2017 The LEGO Group. 6187718

DC All DC characters and elements © & ™ DC Comics.

WB SHIELD: TM & © WBEI. (s17)

**2**

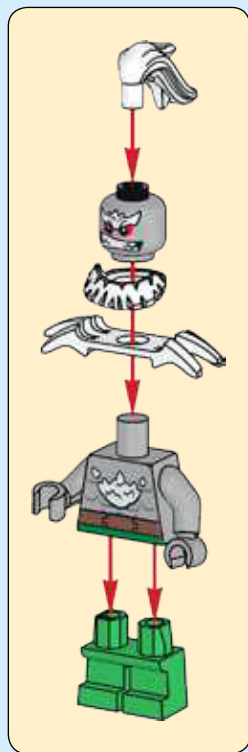

**1**

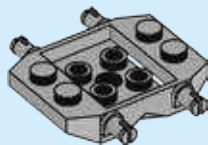

**2**

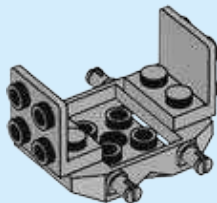

**3**

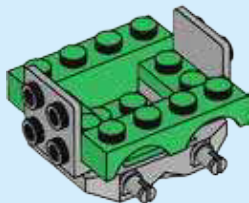

**4**

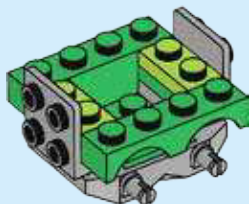

**5**

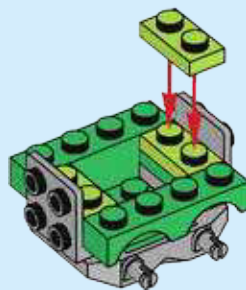

**6**

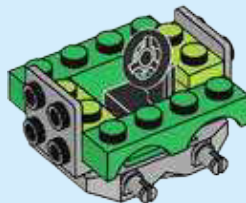

**7**

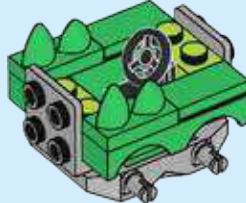

**8**

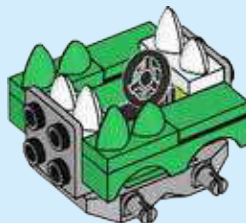

9

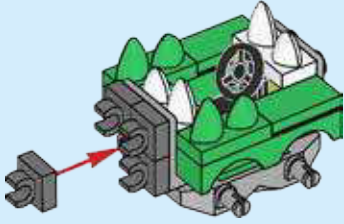

10

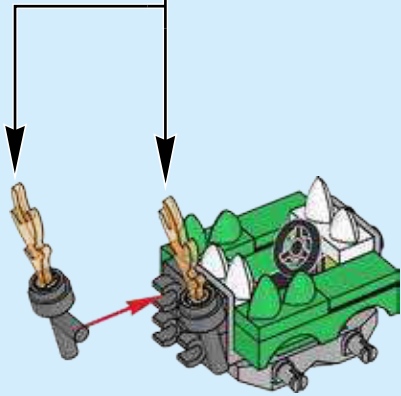
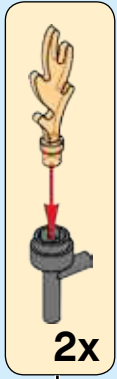

11



12

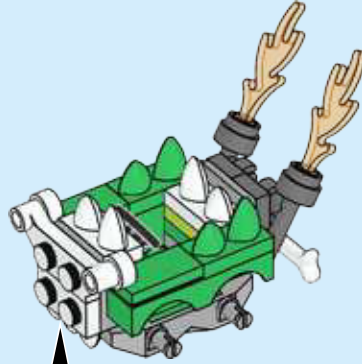
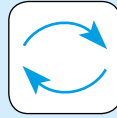

13

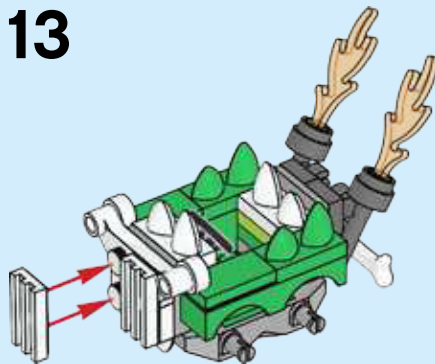

14

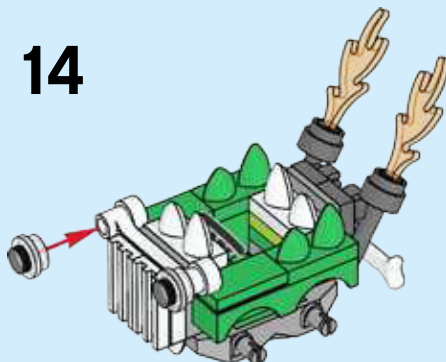

15

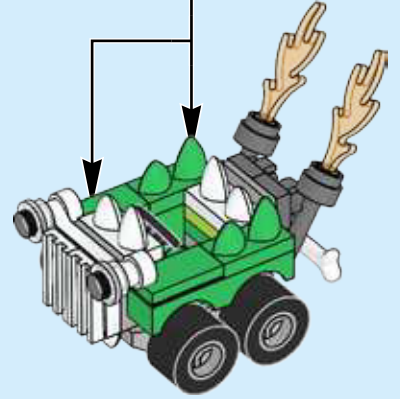
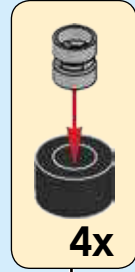



# DC COMICS SUPERHEROES

76070

LEGO and the LEGO logo are trademarks of the LEGO Group. ©2017 The LEGO Group.

DC All DC characters and elements © & ™ DC Comics.

WB SHIELD: TM & © WBEI.  
(s17)

6187724



**WIN**  
GO TO [WWW.LEGO.COM/PRODUCTFEEDBACK](http://WWW.LEGO.COM/PRODUCTFEEDBACK) AND  
GIVE US YOUR SHORT **FEEDBACK** ABOUT THIS  
LEGO® SET FOR A CHANCE TO WIN  
A COOL LEGO PRIZE.

Terms & Conditions apply

# LEGO.com/productfeedback

## GEWINNE



Erzähle uns auf  
[www.LEGO.com/productfeedback](http://www.LEGO.com/productfeedback)

etwas über die Erfahrungen, die du mit  
diesem LEGO® Set gemacht hast, und  
sichere dir die Chance auf einen coolen  
LEGO Preis!

Es gelten die Teilnahmebedingungen

## GAGNE



Rends-toi sur  
[www.LEGO.com/productfeedback](http://www.LEGO.com/productfeedback)

et donne-nous quelques commentaires  
sur ce produit LEGO® pour avoir une  
chance de gagner un prix LEGO !

Voir Conditions Générales

## GANA



Visita  
[www.LEGO.com/productfeedback](http://www.LEGO.com/productfeedback)

y envíanos tu opinión acerca de este set  
LEGO®. ¡Participarás en el sorteo de un  
premio LEGO!

Términos y Condiciones aplicables

## 获取奖品



登录  
[www.LEGO.com/productfeedback](http://www.LEGO.com/productfeedback)

给出关于此乐高®套装的简短反馈，  
就有机会获得炫酷乐高奖品

《条款及条件》适用

 1x 6017091	 1x 6164285	 2x 6046384	 1x 6021969	 1x 73737	 2x 4211506	 2x 3005740	 3x 6167673	 2x 4261397	 1x 6076677
 1x 6171745	 1x 6172334	 2x 241201	 1x 6047415	 2x 4516843	 6x 6011375	 4x 4215618	 1x 4600307	 1x 6167666	
 1x 6171749	 1x 6164295	 1x 6046381	 3x 4164037	 6x 4508215	 1x 6066097	 8x 4244362			
 1x 4543857	 1x 6167866	 1x 6046381	 2x 306928	 1x 73081	 6x 4654580	 1x 6093059			
 1x 6078442	 1x 6172337	 1x 6164280	 2x 6163467	 2x 6134236	 4x 6071226	 1x 4167842			
 1x 6074870	 1x 302001	 1x 6143741	 2x 6134236	 2x 4566028					

Customer Service  
Kundenservice  
Service Consommateurs  
Servicio Al Consumidor

LEGO.com/service or dial



LEGO

DC COMICS  
**SUPER  
HEROES**

**MIGHTY  
MICROS**



[LEGO.com/DCSUPERHEROES](http://LEGO.com/DCSUPERHEROES)

DC All DC characters and elements © & ™ DC Comics.

WB SHIELD: TM & © WBEI.  
(s17)

Apple and the Apple logo are trademarks of Apple Inc., registered in the U.S. and other countries. App Store is a service mark of Apple Inc.

Google Play is a trademark of Google Inc.

Ask parents' permission first.  
Bitte frage erst deine Eltern um Erlaubnis.  
Demande d'abord l'autorisation d'un parent.  
Pide antes permiso a tus padres.  
Pede primeiro permissão aos teus pais.  
Először kérj engedélyt a szüleidtől!  
先请求家长的许可。



Download on the  
App Store

GET IT ON  
Google play



LEGO

DC COMICS  
**SUPER  
HEROES**

76054

76055

76053



76055

76054

76053

DC BATMAN and all related characters and elements © & ™ DC Comics and Warner Bros. Entertainment Inc.

WB SHIELD: TM & © WBEI.  
(s17)

